

ASSEMBLY INSTRUCTION C 015

DESCRIPTION

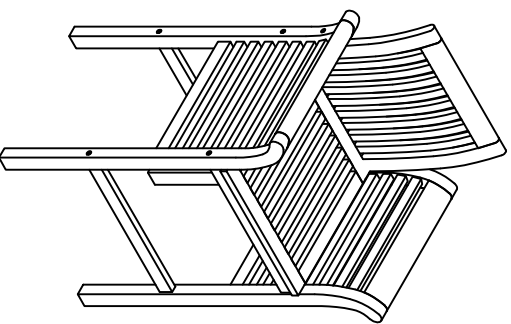

1

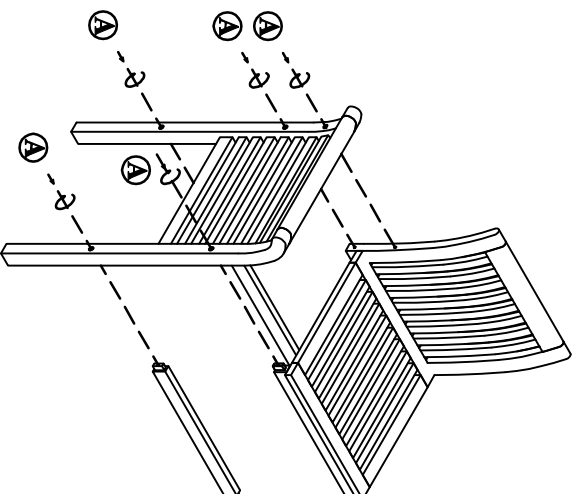

2

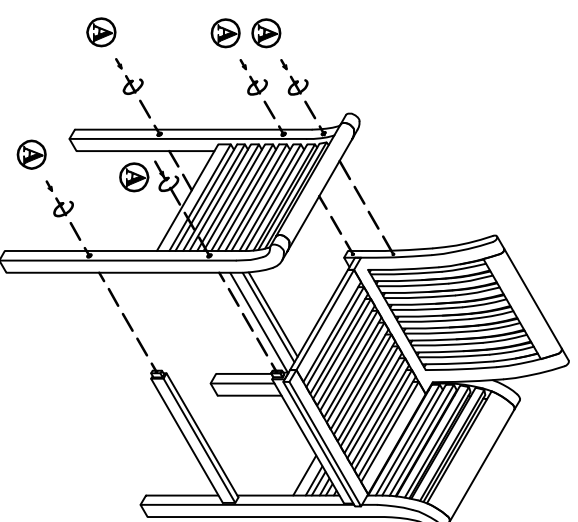

3

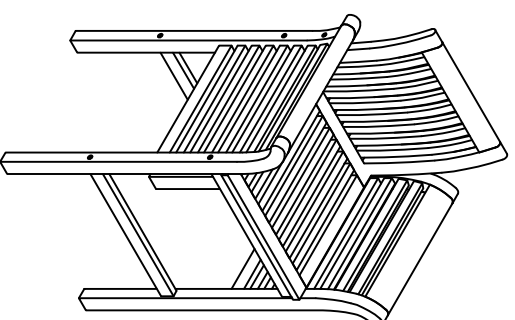

HARDWARE C 015

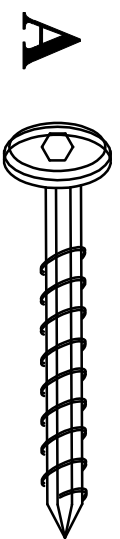

M6 x 60 : 10 PCS

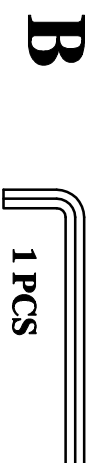

1 PCS