



## Operating Instructions

### 117cm Tower Fan with WiFi



Model: GPTF390

# General Care and Safety Guide

**Thank you for choosing this Goldair product. This Goldair appliance has been designed and manufactured to high standards of engineering and with proper use and care, as described in this leaflet, will give you years of useful service. Please read these instructions carefully and keep them for future reference.**

1. This appliance is not intended for use by persons (including children) with reduced physical, sensory or mental capabilities, or lack of experience and knowledge, unless they have been given supervision or instruction concerning use of the appliance by a person responsible for their safety.
2. Children should be supervised to ensure that they do not play with the appliance.
3. If the supply cord is damaged, it must be replaced by the manufacturer, its service agent or similarly qualified persons in order to avoid a hazard.
4. Ensure that the fan is switched off from the supply mains before removing the guard.
5. Use only the voltage specified on the rating plate of the appliance.
6. Keep all objects at least 1 Metre from the front, sides and rear of the appliance
7. This appliance is intended for household use only and not for commercial or industrial use.
8. Use this appliance only as described in this manual. Any other use is not recommended by the manufacturer and may cause fire, electric shock or injury.
9. The common cause of overheating is deposits of dust or fluff in the appliance. Ensure these deposits are removed regularly by unplugging the appliance and vacuum cleaning the air vents and grills.
10. Always unplug appliance when not in use.
11. When the appliance has been unpacked, check it for transport damage and ensure all parts have been delivered. If parts are missing or the appliance has been damaged, contact the Goldair Customer Services Team.
12. If your appliance does not work, or is not working properly, contact the place of purchase. Repair work on the appliance by unqualified persons can cause serious risk to the user.
13. Ensure hands are dry before handling the plug or the main unit.
14. Carry out regular checks of the supply cord to ensure no damage is evident.
15. Ensure that the cord is fully extended (not coiled) while in use.
16. Avoid contact with the moving parts. Keep hands, hair, clothing, away from blade of the fan during operation to reduce the risk of injury to person and/or damage to the unit.
17. Switch off and use handles provided when moving.
18. It is recommended that this fan is plugged directly into the wall socket.
19. A correctly specified, undamaged extension cord may be used with this fan provided it is used in a safe manner.

# General Care and Safety Guide

20. Never place appliance close to radiant heat source.
21. Never operate in areas where petrol, paint or other flammable liquids are used or stored.
22. Never use the appliance to dry clothes.
23. Never insert or allow foreign objects to enter any ventilation or exhaust opening, as this may cause an electric shock, fire or damage to the appliance.
24. Never use abrasive cleaning products on this appliance. Clean with a damp cloth (not wet) rinsed in hot soapy water only. Always remove plug from the mains supply before cleaning.
25. Never connect the appliance to mains supply until completely assembled and adjusted.
26. Never remove plug from power socket until the appliance has been switched off.
27. Never remove plug from power socket by pulling cord – always grip plug.
28. Never twist, kink or wrap the cord around the appliance, as this may cause the insulation to weaken and split. Always ensure that all cord has been removed from any cord storage area and is unrolled before use.
29. Never use this appliance in the immediate surrounds of a bath, a shower, or a swimming pool or other liquids. The appliance must not be immersed in any liquids.
30. Due to the risk of injury, never use this appliance for any purpose other than its intended use. This appliance is intended for use in household and similar applications such as staff kitchen areas in shops, offices and other working environments; farm houses, by clients in hotels, motels, bed and breakfast type environments and other residential type environments
31. Never use this appliance outdoors.
32. Never operate the appliance with a damaged cord or plug, after it malfunctions, or if it has been damaged in any manner. Have the appliance checked and repaired by a qualified electrician if repair is necessary.
33. Never place the unit in wardrobes or other enclosed spaces as this may cause fire hazards.

<b>Goldair</b>	 T
Model No: GPTF390	
Supply: 220-240VAC 50-60Hz	
Wattage: 45W	
Approval No: TUV023779EA	
MADE IN CHINA	
QC Passed: PO#-WWYY	
<b>CUSTOMER SUPPORT</b>	
<b>NEW ZEALAND PH: 0800 232 633</b>	
<b>AUSTRALIA PH: 1300 465 324</b>	

# General Care and Safety Guide

The remote control supplied with this fan uses a CR2025 coin type battery.



## **DANGER IF SWALLOWED**

Keep batteries out of reach of children. Swallowing may lead to serious injury or death in as little as 2 hours due to internal burns.

If swallowed, go straight to a hospital emergency room.

Dispose of used batteries immediately.

**WARNING!**



**DANGER IF SWALLOWED**

Keep batteries out of reach of children. Swallowing may lead to serious injury or death in as little as 2 hours due to internal burns.

**If swallowed, go straight to a hospital emergency room.**

Dispose of used batteries immediately.

# Assembly

- The base of the tower fan comes in two parts, which fit around the oscillation base.
  - Both parts fit easily together. The back half is the one with cut-outs for the power supply cord.
  - For ease of assembly, turn the unit upside down ensuring that you are careful not to damage the top of the fan.
  - First remove the large plastic nut from the bottom of the main fan body.
  - Attach the front half of the base, aligning the holes in base with the locating lugs in the oscillation base, and leading the power cord through the centre hole.
  - Then snap the back half of the base to the front half and secure to the base of the fan with the large plastic nut.
- 
- Stand back up and stand the fan upright on its base ensuring it doesn't tip over

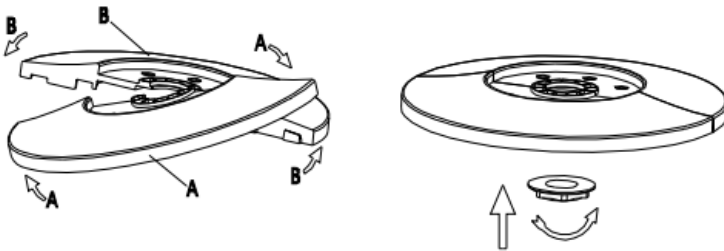

- Thread the power supply cord through the two cut-outs at the bottom of the base.



# Operating your Fan

Always choose a safe location for the fan, keeping in mind the safety precautions outlined. Ensure all packaging has been removed from the unit before use. This appliance requires no installation, it should be used solely as a portable appliance.



**WARNING: Keep all objects at least 1 metre from the front, sides and rear of the appliance. IMPORTANT! NEVER COVER THIS APPLIANCE!**

Place the fan on a dry, level and sturdy surface.

Ensure the fan speed control is on the OFF position before plugging the power cord into the socket.

## Fan control

The fan can be operated by the manual controls located on the top of the fan or by the remote control.

**POWER:** Turn the FAN ON by pressing the  button. Turn the FAN OFF by pressing the  button again.

**SPEED:** You can adjust the fan speed to the desired level: low (I), medium (II), or high (III) by pressing 'SPEED'. The speed setting is displayed on the LED panel.

**MODE:** Pressing the 'MODE' button will set the FAN into NORMAL, NATURAL, SLEEP or CHILD mode.

- NORMAL Mode: the fan will work at any speed you set up.
- NATURAL Mode: the fan will start work at high speed(15s), middle speed(15s) and low speed(15s), it works as per this recycle.
- SLEEP Mode: if you set the mode at high speed, fan will work at high speed at 30 mins, then transfer to middle speed at 30 mins and transfer to low speed until fan stops working.
- CHILD Mode: Fan will automatically set the timer at 3 hours and the oscillation function will start. The fan will work at high speed at 15 minutes, transfer to middle speed at 15 minutes, then transfer to low speed until it turns off. You can stop the oscillation function by pressing the oscillation button.

**TIMER:** The fan is equipped with a timer that allows you to set it's length of operation from 1 hour to 12 hours (in 1hr increments).

**OSC:** Pressing the 'OSC' button will start and stop the oscillation function.

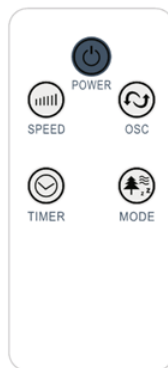
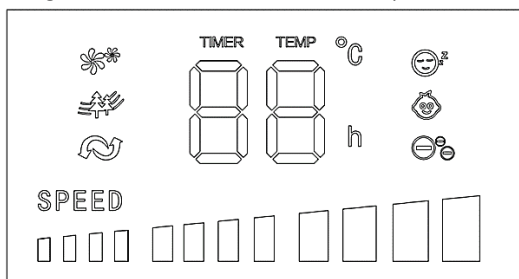
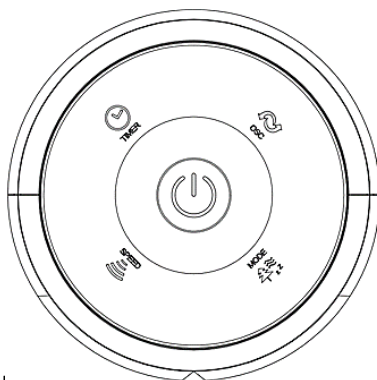

# Operating your Fan

## Remote control

The remote requires a line-of-sight path to allow for the signal to be received by the unit. Position the unit so the receiver lens is visible from the remote control.

The symbols on the remote correspond to the symbols on the main unit.

1 x CR2025 size battery is required.

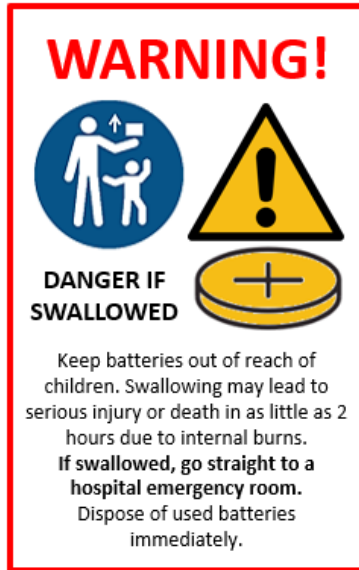
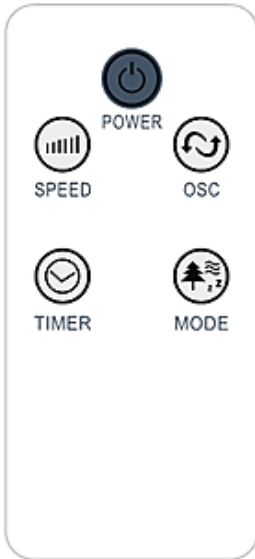

# WiFi – Downloading and Setting up APP

**This APP is supported only on 2.4GHz Wi-Fi channels. Please ensure your phone is 2.4GHz capable**

**Note this device will only work within your home WIFI system.  
This does not operate on 3G or 4G internet connections.  
You will need a connection to your home Wi-Fi.**



Download Goldair mobile APP

- Open the APP Store or Google Play on your mobile phone.
- Open 'Search' and enter 'Goldair'
- Click 'GET' and begin to download and install.

Once downloaded to your phone open the APP

- Tap REGISTER near the bottom of the screen.
- Read and agree to the Privacy Policy.
- Add your email address.
- Tap 'Obtain verification code'

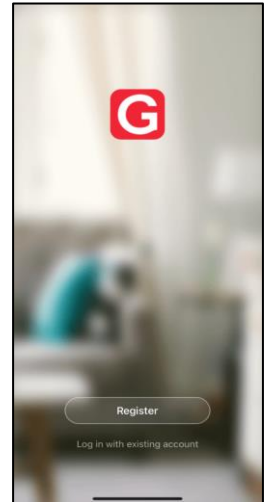

You will then receive an email with a verification code.

- Enter the verification code from your email.
- Create a password.
- Then tap confirm.

If you haven't received a verification code via email, tap the resend button and when the verification code is received follow above steps.

Your APP is now registered and ready for pairing to your device.

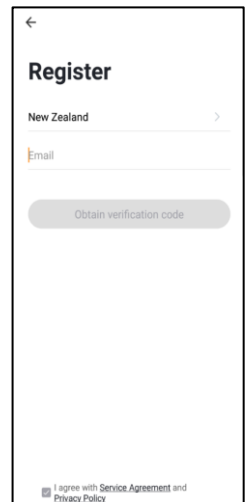
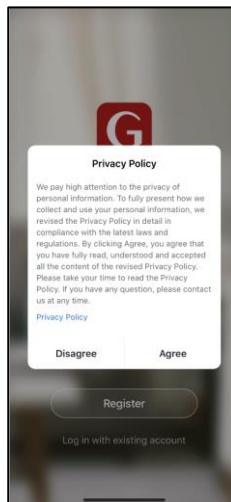



# Pairing APP to Device

Details for pairing this heater to the Goldair App can be found at the below website link.

Either scan the QR code below or enter the website into your browser.

## New Zealand Products



<https://www.goldair.co.nz/goldair-app>

## Australia Products



<https://www.goldair.com.au/goldair-app>

## Pairing Mode

To connect to the Goldair app you must ensure that your device is in pairing mode which is where the Wifi Icon is flashing. Most products will be in pairing mode after switching the device on but if it is not:

- Put device on STAND-BY mode (ON at the wall but device is OFF)
- Hold down "OSCILLATION" for around 5 seconds or until the Wifi icon begins to flash.

# Cleaning

The fan requires regular cleaning to ensure trouble free operation.

Unplug the fan from the mains supply before cleaning.

Use a damp cloth (not wet) to wipe the exterior of the fan to remove dust and dirt.

Use a vacuum cleaner to remove dust and fluff from around the grills.

Ensure the fan is dry before plugging back into the mains supply.

Do not attempt to dismantle the fan. There are no user serviceable parts.  
For service or repair, contact an authorised electrical service technician.

## PROOF OF PURCHASE

To receive warranty retain receipt as proof of purchase. (Refer to back of booklet).

**Goldair™**

### SUPPORT AND TECHNICAL ADVICE

**Goldair – New Zealand**  
Monday – Friday 8am-5pm  
Phone +64 (0)9 917 4000  
Phone 0800 232 633  
info@cdb.co.nz

**Goldair – Australia**  
Monday – Friday 8am-5pm  
Phone +61 (0)3 9365 5100  
Phone 1300 465 324  
info@cdbgoldair.com.au



## Two Year Warranty

Thank you for purchasing this Goldair Platinum product. Your product is warranted against faults and manufacture when used in normal domestic use for a period of **two year**. In non-domestic use Goldair limits the voluntary warranty to **three months**.

Goldair undertake to repair or replace this product at no charge if found to be defective due to a manufacturing fault during the warranty period.

This warranty excludes damage caused by misuse, neglect, shipping accident, incorrect installation, or work carried out by anyone other than a qualified electrical service technician.

PLEASE KEEP YOUR RECEIPT AS THIS WILL HELP VERIFY YOUR WARRANTY.

The benefits to you given by this warranty are in addition to other rights and remedies available to you under a law in relation to the goods or services to which this warranty relates.

In Australia, our goods come with guarantees that cannot be excluded under the Australian Consumer Law. You are entitled to a replacement or refund for a major failure and compensation for any other reasonably foreseeable loss or damage. You are also entitled to have the goods repaired or replaced if the goods fail to be of acceptable quality and the failure does not amount to a major failure.

In New Zealand this warranty is additional to the conditions and guarantees of the Consumers Guarantee Act (1993).

### Goldair – New Zealand

CDB Goldair  
PO Box 100-707  
N.S.M.C  
Auckland, 0745

Phone +64 (0)9 917 4000

Phone 0800 232 633

[www.goldair.co.nz](http://www.goldair.co.nz)

### Goldair – Australia

CDB Goldair Australia Pty  
PO Box 574  
South Morang  
Victoria, 3752

Phone +61 (0)3 9365 5100

Phone 1300 GOLDAIR (1300 465 324)

[www.goldair.com.au](http://www.goldair.com.au)

### Goldair One Year Warranty (IMPORTANT: Please complete and retain this warranty card)

Name \_\_\_\_\_

Address \_\_\_\_\_

Place Of Purchase \_\_\_\_\_ Date of Purchase \_\_\_\_\_

Name Of Product \_\_\_\_\_ Model Number \_\_\_\_\_

Attach a copy of the purchase receipt to this warranty card

Due to continual design improvements, the product illustrated in this User Manual may differ slightly from the actual product.

# Goldair™

PLATINUM



CDB  Goldair™

New Zealand  
PO Box 100707,  
North Shore Mail Centre,  
Auckland, 0745  
[www.goldair.co.nz](http://www.goldair.co.nz)

Australia  
PO Box 574,  
South Morang,  
Victoria, 3752  
[www.goldair.com.au](http://www.goldair.com.au)