

MALONE[®]

CHANGING THE WAY YOU GET THERE

KAYAK HAMMOCK[™]

DELUXE HOIST SYSTEM

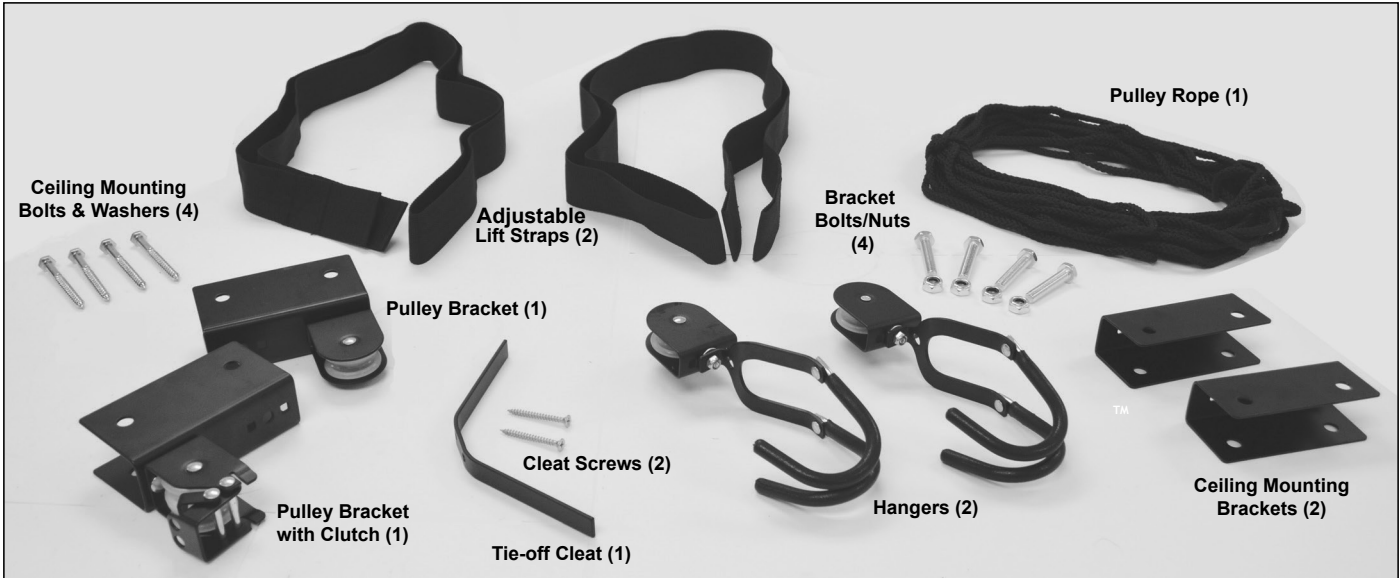

Installation & Loading Instructions - Please Read Before Beginning

1. Install the Ceiling Mounting Brackets

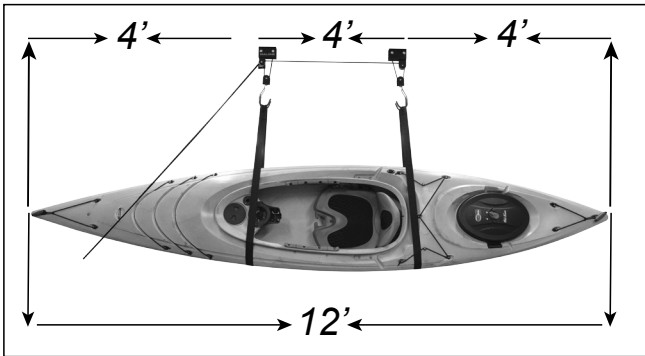
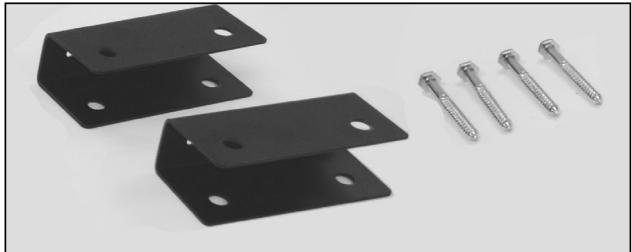

To determine the length required between the two brackets, measure the length of the load to be lifted and divide by 3.

The Mounting Brackets must be attached to the center of a ceiling stud. If the stud is covered by drywall, use a stud locator to find. Using one of the Brackets as a template, mark the two mounting hole locations in the stud. Repeat for the 2nd bracket location. The total distance between the two brackets should be the length calculated above.



MALONE[®]

CHANGING THE WAY YOU GET THERE

1. Install the Ceiling Mounting Brackets (continued)



Using a 3/16" bit, drill pilot holes in all four marked mounted hole locations.

Align the Ceiling Mounting Brackets and start them in all four drilled hole locations.

Using a 1/2" or 13mm deep socket wrench (or extension), firmly tighten all four bolts.

Confirm that both Ceiling Brackets are aligned.

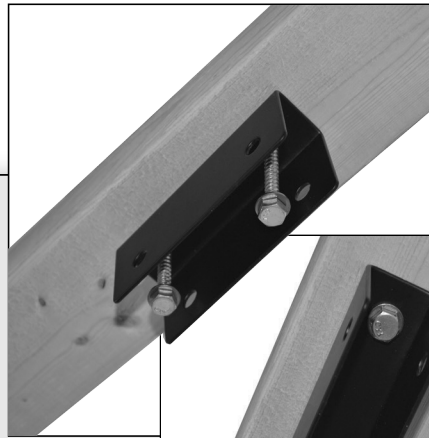

2. Install the Pulley Brackets

Install the Pulley Bracket with Clutch to a Mounting Bracket. Align the mounting holes and install two Bracket Bolts. Hand tighten two Bracket Nuts.

Note: The bracket should be installed so that the pulley is located on the outside of the assembly.

Repeat this process for the Pulley Bracket and 2nd Ceiling Mounting Bracket.



MALONE

CHANGING THE WAY YOU GET THERE®

2. Install the Pulley Brackets (continued)

Using a 11/16" or 17mm socket and wrench, firmly tighten all four Bracket Nuts.

Note: Do not overtighten as this can cause the brackets to deform and weaken the assembly.

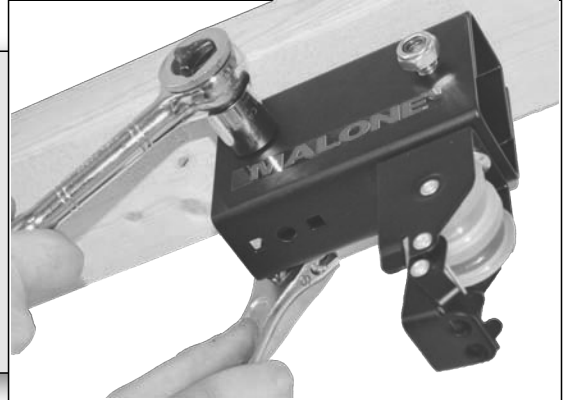

3. Install the Pulley Rope and #1 Hanger

Dress a free end of the Pulley Rope up through one of the round holes in the bottom of the pulley clutch.

Dress the rope behind the clutch lock (the small metal piece with two bumps on the top side).

Pull enough rope up through the clutch mechanism to have 8"-12" to work with for the next step.

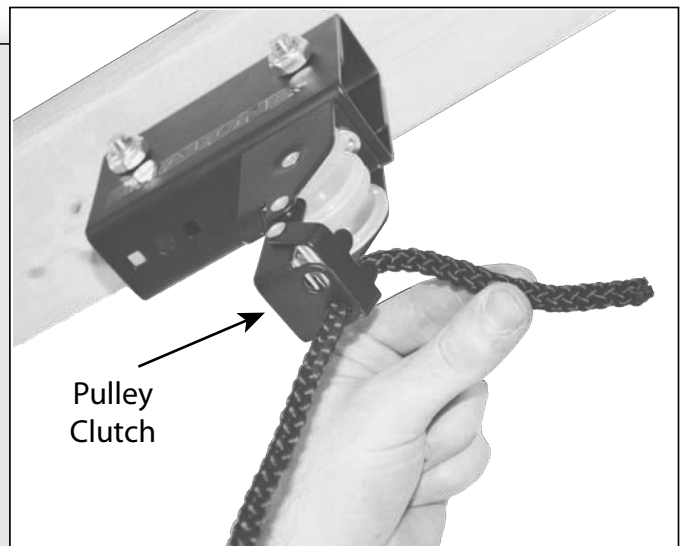

Dress the free end of the Pulley Rope up and over either pulley.

Note: Use the same side pulley as used when dressing the rope up through the bottom hole in the clutch.

Pull the free end of the Pulley Rope down to the floor.

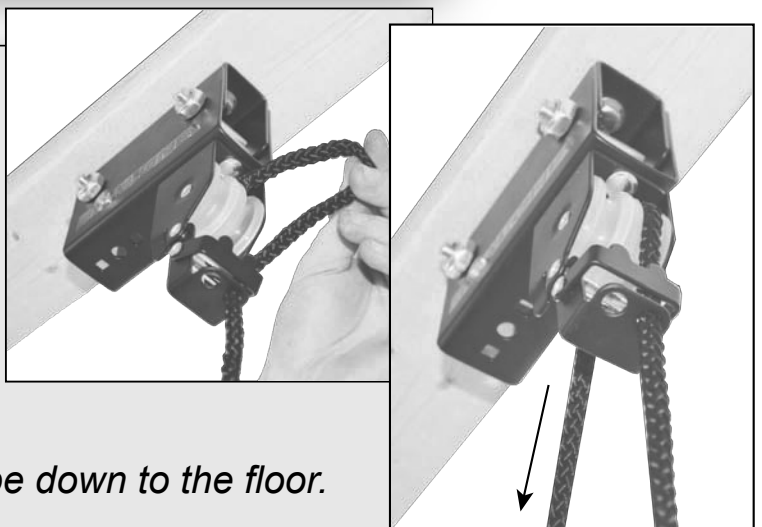

MALONE

CHANGING THE WAY YOU GET THERE®

3. Install the Pulley Rope and #1 Hanger (continued)

Dress the free end of the Pulley Rope (same end as used in previous steps) through the pulley on one of the Hangers.

Pull enough rope up through the Hanger pulley to have 5'-6' to work with for the next step.

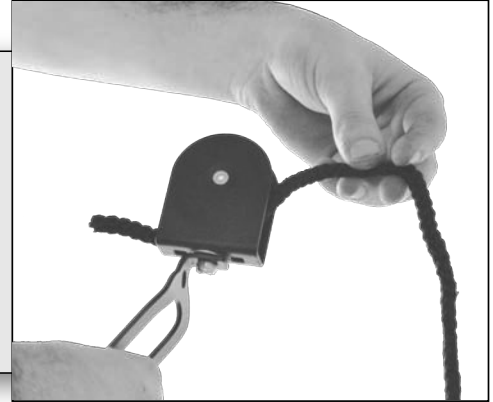

Dress the free end of the Pulley Rope up through the round hole in the bottom of the Pulley Bracket and out the end.

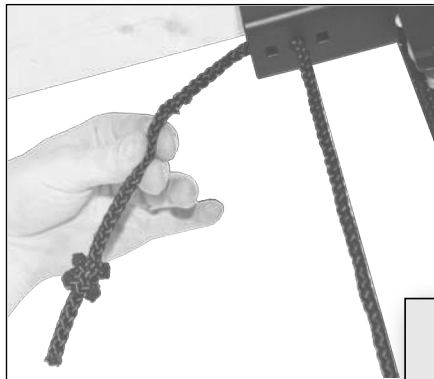
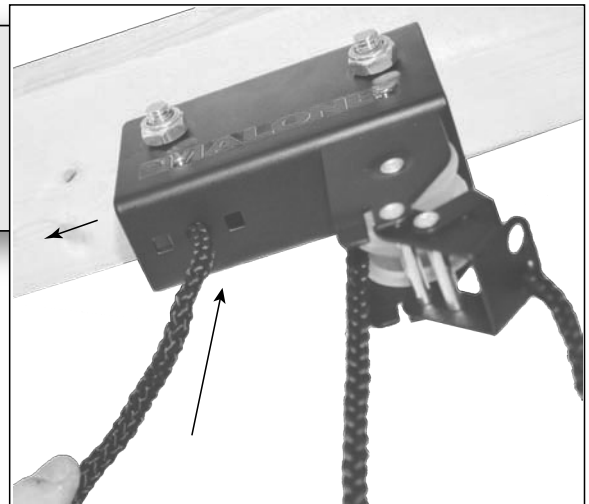

Tie a double square knot at the free end of the Pulley Rope.

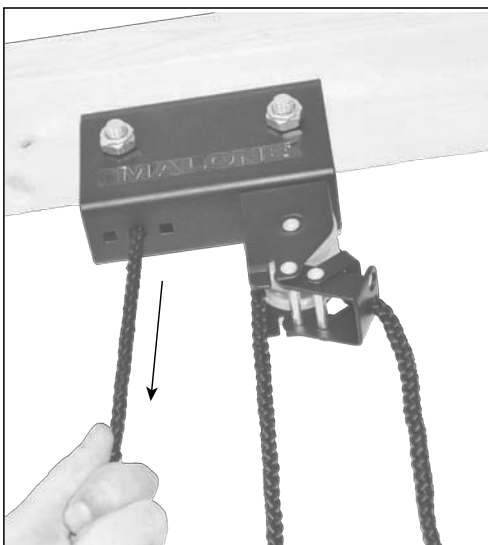

Pull down the rope located between the Pulley Bracket and Hanger. This will pull the knot back into the bracket.

Note: Apply downward pressure on the rope to confirm the knot is secure.

MALONE

CHANGING THE WAY YOU GET THERE[®]

3. Install the Pulley Rope and #1 Hanger (continued)

This completes the installation of the first Hanger.

You should now be able to raise and lower the Hanger by pulling the rope straight down which releases the clutch and allows rope movement.

Note: Add a small amount of weight to the Hanger to test and familiarize yourself with the workings.

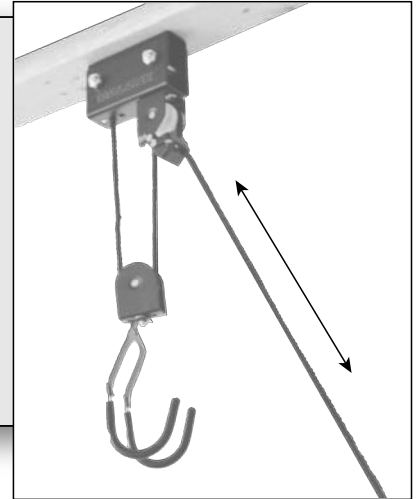

4. Install the Pulley Rope and #2 Hanger

Using the remaining free end of the rope, we will now repeat the same steps used with the #1 Hanger to dress the clutch and pulley.

- 1. Dress the free end of the rope up through the second round hole in the bottom of the pulley clutch.*
- 2. Dress the free end of the rope behind the clutch lock.*
- 3. Dress the free end of the rope up and over the second pulley.*

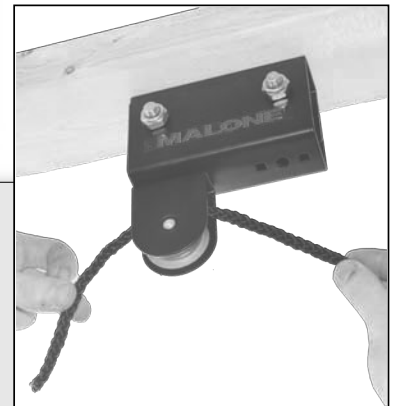
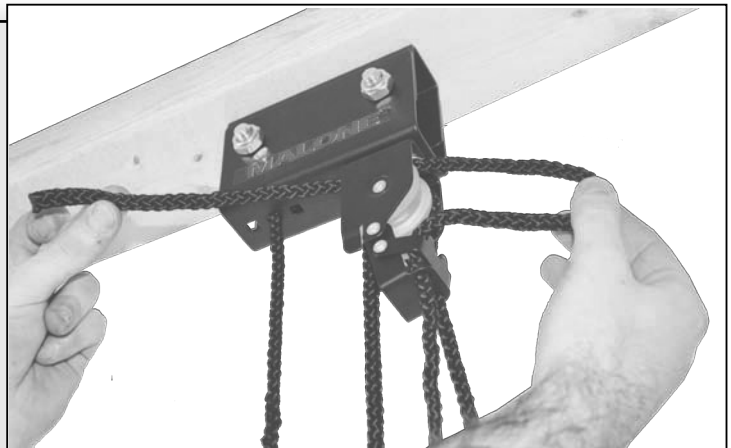

Pull the free end of the rope over to the other Pulley Bracket.

Dress the free end over the pulley and down to the floor.

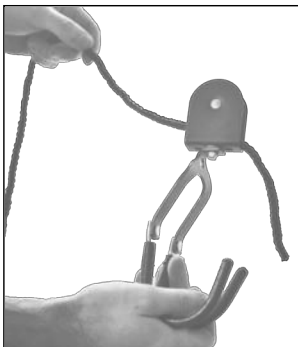

Dress the free end under the pulley of the 2nd Hanger.

MALONE

CHANGING THE WAY YOU GET THERE®

4. Install the Pulley Rope and #2 Hanger (continued)

Dress the free end of the Pulley Rope up through the round hole in the bottom of the Pulley Bracket and out the end.

Tie a double square knot at the free end of the rope. Pull down the rope located between the hanger and the bracket. This will pull the knot back into the bracket.

Note: Apply downward pressure on the rope to confirm the knot is secure.



5. Install the Cleat and Test the System.

Install the Tie-off Cleat to complete the installation.

The cleat should be fastened to solid wood (vertical wall stud) using the two Phillips Screws provided.

Position the cleat so that the excess rope can be tied off at a high angle to prevent the clutch from disengaging.

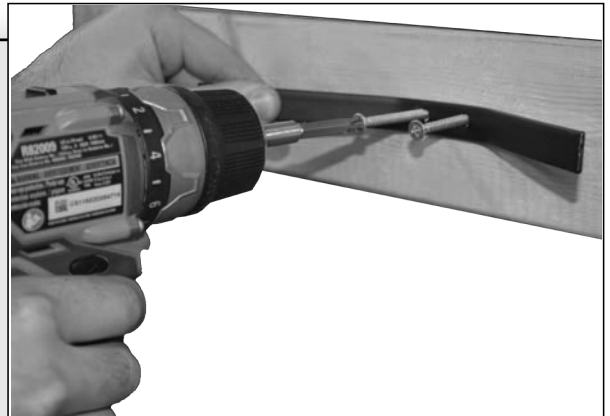

Before attempting actual use of the hoist, familiarize yourself with the workings.

*Install a small weight on each Hanger. Raise the Hangers together, and then, separately. Move the Pulley Rope loop to a low angle to release the clutch to lower the Hangers. Confirm you understand that releasing the clutch allows **BOTH** ropes to release.*

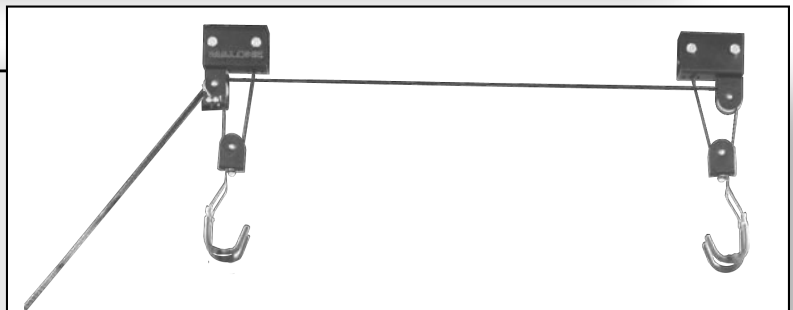

MALONE

CHANGING THE WAY YOU GET THERE®

6. Using the Kayak Hammock

Overall Specifications:

- . Load Capacity: 120 LB (55 kg)
- . Maximum Ceiling Height: 14 feet (4.3 m)
- . Minimum Ceiling Height: 9 feet (2.7 m) Allows 6 feet of clearance between floor and kayak.

To store a kayak, begin by lowering the Hangers so they are just above the kayak.

Pass the two 6' Lift Straps under the kayak. Place the loops on each end of the straps over the hooks on each Hanger. Extra 'Loops' are provided to adjust for hull size.



Slowly pull both the ropes together until the kayak lifts off the ground (or vehicle). Each rope controls one end of the kayak for fine adjustment.

With the kayak slightly suspended, slowly release the ropes. The clutch should engage and hold the kayak in place. Confirm the load is balanced and the straps positioned evenly as required (see Page 1).

Continue to hoist the kayak to the desired height again by pulling BOTH ropes together. When EITHER or BOTH ropes are pulled, the clutch is released. When making fine adjustments, keep firm control on BOTH ropes.

When in the final desired storage position, release both ropes at the same time to engage the clutch. The Tie-Off Cleat should ALWAYS be used to secure the ropes.

To lower the boat, slowly apply tension to both ropes to disengage the clutch. Carefully feed the ropes evenly to keep the kayak level as it descends. DO NOT attempt to lower each end independently. This will cause the other side to suddenly release, and or, slide out of the straps.

MALONE

CHANGING THE WAY YOU GET THERE®

5. Other Uses:

The Kayak Hammock is capable of lifting and storing a wide range of product within its maximum weight capacity of 120 LB.

For Cargo Boxes: Duplicate the usage instructions for kayaks.

For Bikes: Use the Hangers only and follow the same lift and lowering guidelines as defined in the usage instructions for kayaks.

For Ladders: Duplicate the usage instructions for kayaks.

6. Precautions and Liability Statement:

- *Designed for indoor use only. Do not use for outside installation.*
- *Check all rope and hardware connections before each and every use, replace rope annually or when showing signs of wear.*
- *Use only in areas clear of any potential hazards (never install or use in walkways, work areas. Don't walk or stand under a raised load.*
- *Not to be used for people or pets.*
- *Weight must be evenly balanced & level when raising and lowering load.*
- *Maximum distributed weight limit is 120 lb. (60 lb. per hanger pulley set).*

WARNING! Strictly follow all instructions to avoid an accident, damage to property, personal injury or death.

WARNING! This product is not to be used for human suspension. Components may fail causing person to fall, possibly resulting in serious injury or death.

DISCLAIMER * WARNING

All storage systems are potentially hazardous. Any persons using MALONE AUTO RACK products are personally responsible for following the given directions for use and installation and accepts full and complete responsibility for any and all damages or injury of any kind including death, which may result from use.

MALONE AUTO RACKS 81 County Rd. Ste 1, Westbrook, ME 04092

P: 207.774.9100 F: 207.615.0551

E: support@maloneautoracks.com W: www.maloneautoracks.com

MALONE

CHANGING THE WAY YOU GET THERE

Limited Lifetime Warranty

The Malone Auto Racks (Malone) Limited Lifetime Warranty covers certain Malone-brand products that have been specifically identified for inclusion in the program and is effective for as long as the original retail purchaser owns the product. This warranty is terminated when the original retail purchaser sells or otherwise transfers the product to any other person or entity.

Subject to the limitations and exclusions described in this warranty, Malone will remedy defects in materials and/or workmanship by repairing or replacing, at its option, a defective product without charge for parts or labor. Malone may elect, at its option, not to repair or replace a defective product but rather issue to the original retail purchaser a refund equal to the purchase price paid for the product, or credit to be used toward the purchase of a replacement Malone product.

This warranty does not cover, and no warranty is given for defects or problems caused by normal wear and tear, which includes, but is not limited to, surface (aesthetic) metal corrosion, scratches, dents, deformities, accidents, unlawful vehicle operation, or any modification of a product not performed or authorized in writing by Malone.

In addition, this warranty does not cover problems resulting from conditions beyond Malone's control including, but not limited to, theft, misuse, overloading, or failure to assemble, mount or use the product in accordance with Malone's written instructions or guidelines included with the product provided to the original retail purchaser.

No warranty is given for Malone products purchased outside of the continental United States, Canada and Mexico.

If the product is believed to be defective, the original retail purchaser should contact the Malone dealer from whom it was purchased, who will give the original retail purchaser instructions on how to proceed. If the original retail purchaser is unable to contact the Malone dealer, or the dealer is not able to remedy the defect, the original retail purchaser should contact Malone by email at support@maloneautoracks.com.

In the event that the product must be returned to Malone, a technician at the email address above will provide the original purchaser with return shipping instructions. The original purchaser will be responsible for the cost of mailing the product to Malone. In order to be eligible to receive any remedy under this warranty, a copy of the original purchase receipt, a description of the defect and a return address must be provided.

Disclaimer of Liability

Repair or replacement of a defective product, or the issue of a refund or credit (as determined by Malone) is the original retail purchaser's sole and exclusive remedy under this warranty. Damage to original purchaser's vehicle, cargo, or property, and/ or to any other person or property is not covered by this warranty.

This warranty is expressly made in lieu of any and all other warranties, express or implied, including the warranties of merchantability and fitness of a particular purpose

Malone's sole liability to any purchaser is limited to the remedy set forth above. In no event will Malone be liable for any direct, indirect, consequential, incidental, special, exemplary, or punitive damages, or, for any other damages of any kind or nature (including but not limited to, lost profits, lost income or lost sales).

Some states do not allow the exclusion or limitation of incidental or consequential damages, so the above limitations may not be applicable.

In addition, all vehicular transports are potentially hazardous. Any person(s) using Malone products are personally responsible for following the given directions for use and/or installation and accepts full responsibility for any and all damages or injury of any kind including death, which may result from their use and/or installation.

MALONE AUTO RACKS 81 County Rd. Ste 1, Westbrook, ME 04092
P: 207.774.9100 F: 207.615.0551
E: support@maloneautoracks.com W: www.maloneautoracks.com