

MALONE®

****ATTENTION CUSTOMERS****

**Thank you for your recent purchase of a Malone CrossBed™
Truck Bed CrossRail System.**

Please inspect all parts and hardware bags prior to assembly.



**If you encounter damage of any packaging or parts, or find that
parts are missing - please email us with photos
and your Proof of Purchase at:**

Email: support@maloneautoracks.com

Thank you from all of us at Malone

MALONE[®]

CHANGING THE WAY YOU GET THERE

Important Note

Product Warranty & Registration Form

All information is confidential and used exclusively by MALONE only.

Dear Customer,

Thank you for your purchase of a Malone Product.

In order to be eligible for the Malone Warranty program, we ask that you contact us online at the link provided below within 30 days of purchase. You can also mail this letter back to the address at the bottom.

- Online: <https://maloneautoracks.com/product-registration.php>

We will require the information below.

Here is the information collected:

First Name: _____

Last Name: _____

Address: _____

Address2: _____

City: _____

State: _____

Zip: _____

Country: _____

Email: _____

Phone: _____

Product Description/Name: _____

Product MPG#: _____

Date Purchased: _____

Store Where Purchased: _____

Purchase Price: _____

Thank you for choosing Malone!

Please Note: Registration Form is not a valid Proof of Purchase. Please retain your original receipt for any future warranty claims.

MALONE AUTO RACKS 81 County Rd. Ste 1, Westbrook, ME 04092

P: 207.774.9100 F: 207.615.0551

E: support@maloneautoracks.com W: www.maloneautoracks.com

MALONE®

CHANGING THE WAY YOU GET THERE

CrossBed™ Truck Bed CrossRail System

Model MPG923 Assembly Instructions



Take a few moments and read through these instructions to familiarize yourself with the step by step assembly process before you begin turning wrenches.

Unpack and sort the components into groups as shown in the following pages.

Then assemble each group in order. Lets get started !!

Required Tools:

- 5mm Allen wrench (provided)
- 8mm Allen wrench (provided)
-

*Visit us at maloneautoracks.com
for more fine products and accessories.*

Group 1: Load Bars & Supports

Load Bars (2)

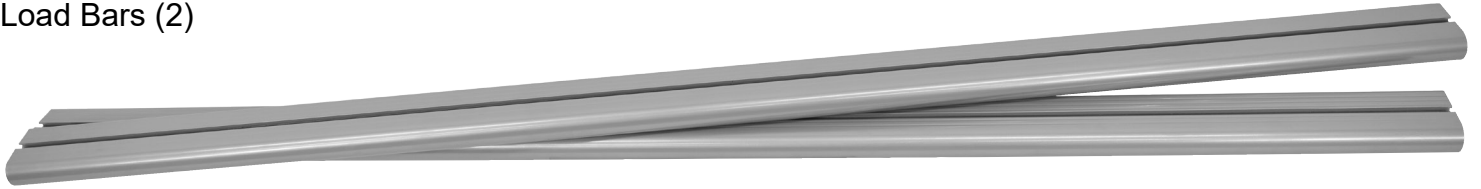

Support Towers (4)



Load Stops (4)

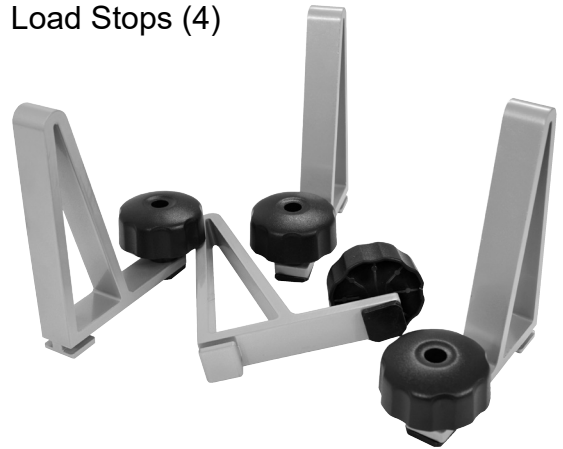

Tower Hardware (4)

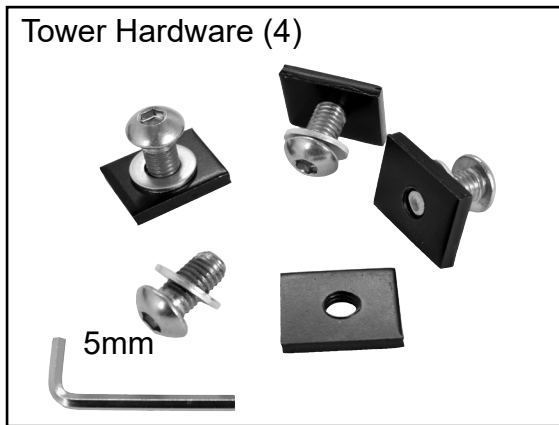

Rubber Insert (1)



End Caps (4)



Group 2: Mounting Brackets

Mounting Brackets w/
Hardware (4)

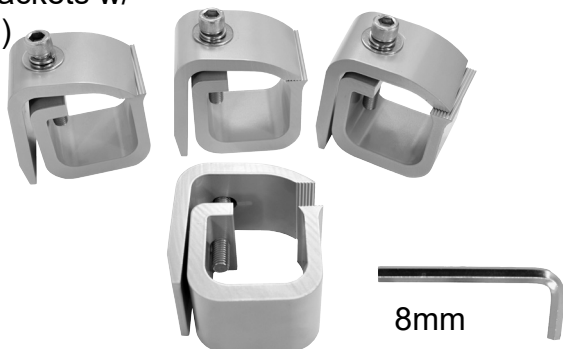

*Toyota Fit Kit

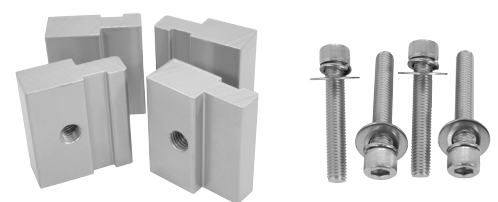

***For use with Toyota Tundra
& Tacoma Trucks.
100mm Bolts to be used w/ fit kit only.**

ASSEMBLY

1. First, open the hardware bag and remove the 5mm Allen wrench along with 4 pieces of hardware (Allen bolt, washer and T-nut).



2. Insert the bolt and washer through the backside of the support tower as shown. Apply the T-nuts and leave them loose. Repeat with all remaining support towers.



Begin the next step by first identifying the bottom of the load bar by locating the mounting hole used for the end caps. This hole is along the bottom edge as pictured here.

3. Align the t-nut(s) to the channel along the bottom of the load bar and insert the support tower approximately 6". Tighten slightly.

NOTE: The 'front' load bar will have the rounded edge facing forward, towards the cab of the vehicle.

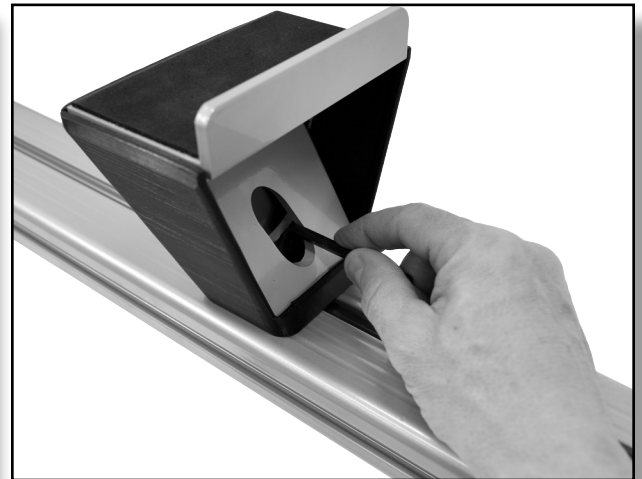
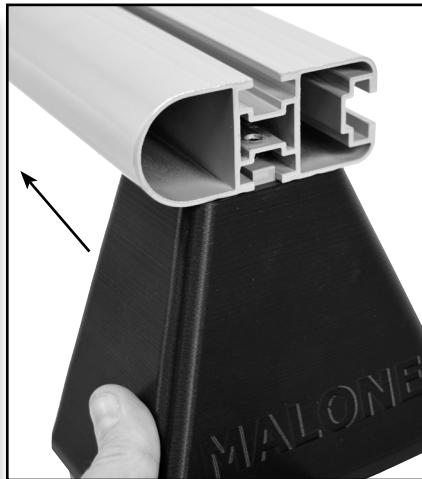
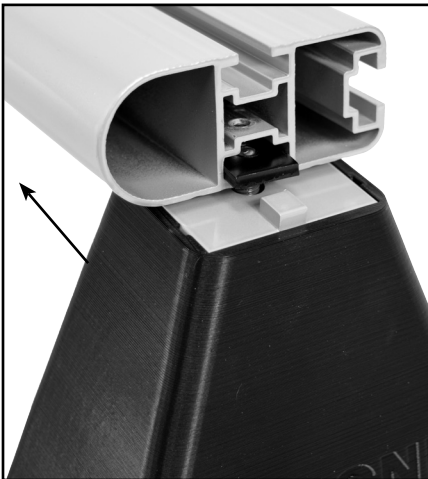
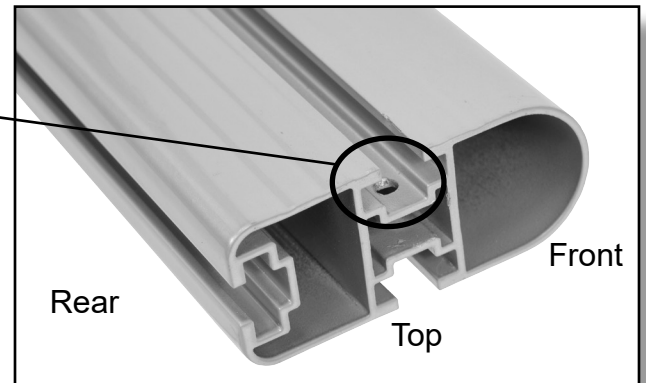

4. Repeat this step with the 3 remaining support towers. Your assembly should like the picture below.

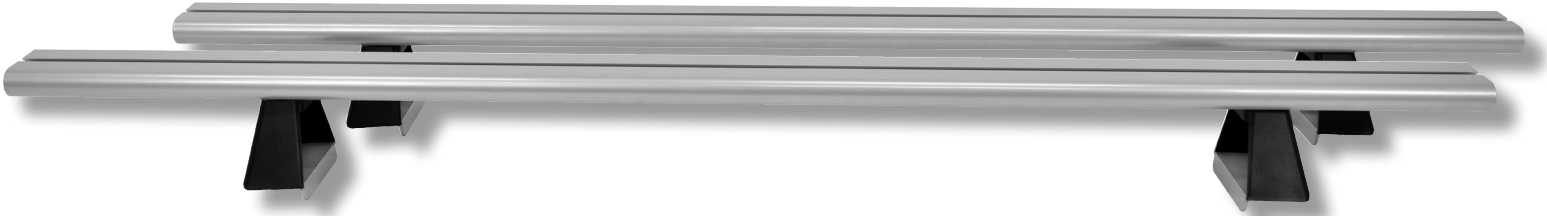

INSTALLATION

1. Place the padded support towers onto the bed rail of the truck as pictured. Adjust as needed so both support towers rest on the bed rail in desired position.
2. Measure the load bar extending past the support tower and make even on both sides.
3. With the support towers in position and the ends measured evenly, tighten the support towers to the load bar. Repeat steps with second load bar.

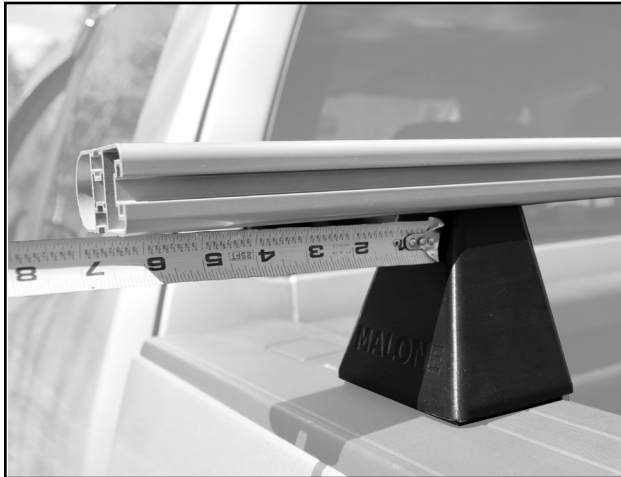

4. Pair one upper and lower mounting bracket with a mounting bolt and washers to secure the support towers to the trucks bed rail. Clamp the mounting bracket around the beds railing and the base of the support tower. Secure fully with provided 8mm wrench. Repeat with the remaining mounting brackets and support towers.

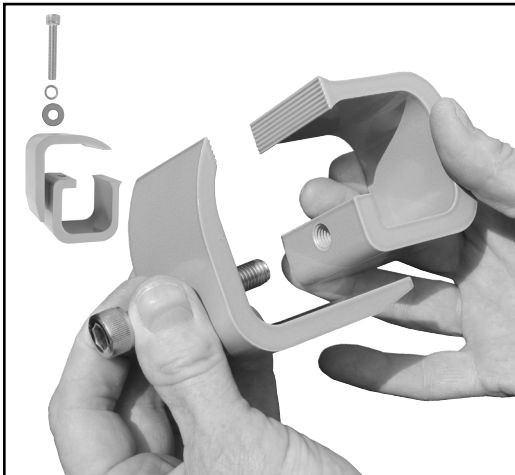

NOTE: Toyota users will replace the bottom bracket with the provided Toyota Fit Kit and 100mm Bolts.
PICTURES ARE FOR REFERENCE ONLY

*Toyota Fit Kit

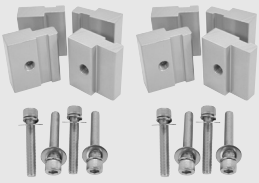

***For use with
Toyota Tundra
& Tacoma Trucks.
100mm Bolts to be
used w/ fit kit only.**

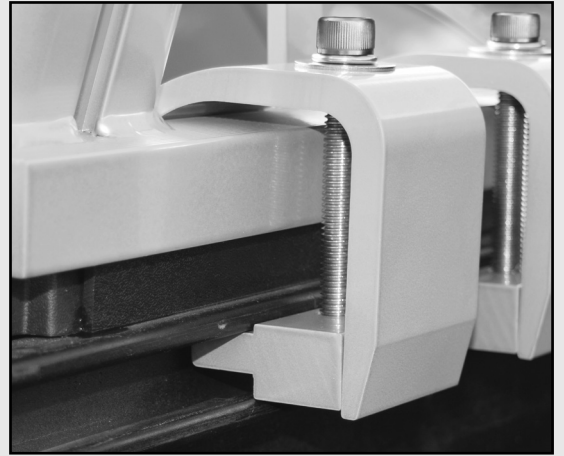
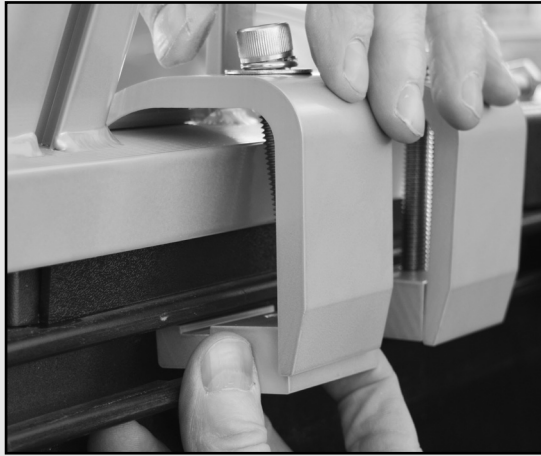

LOAD STOPS

With the load bars installed and secured, we can complete the assembly with the load stops, end caps and rubber inserts.

Load stops provide adjustable, secure tie off points as well as stable bracing points for narrow loads.

If adjusting frequently, it is recommended not to install the rubber insert as shown in the next steps.

For fixed mounting points adding the rubber insert will help reduce and wind noise as well as provide some minor protection of items rubbing on the load bar. Cut to length, as needed.

- Before the end caps are installed, align and install the load stops into the load bars t-slot along the top. Place in desired position and tighten with the hand knob. Note: The hand knobs are on the outside.
- The rubber inserts can be cut to length and inserted at your own choosing. It will help with minor wind noises and can prevent whistling in some scenarios.
- Simply measure and cut to desired length, and insert into the channels of the cargo system. There should be enough to fill the top of both load bars.



5. Pair a small nut with an end cap and insert the nut into the middle cavity of the end cap. Push the end cap into the load bars open end and secure with small screw from the bottom.
6. With the ends caps installed, complete the assembly with the rubber insert along the top slot of the load bar. This will help reduce and wind noise as well as provide some minor protection of items rubbing on the load bar. Cut to length.



This completes the assembly of your Malone Truck Bed Cross Rail System. Be sure to go over and double check all hardware to insure the system is secure before using.



WARNINGS

- Do not exceed a max load of 500lbs. w/ balanced load
- Remove the product before entering a car wash.
- Periodically check all hardware to insure the system is secure and safe.
- Adapt your driving to the load being transported. Obey all posted speed limits & traffic cautions.
- Will not work with tonneau covers. If your truck has a bed liner some alteration may be required to properly install this cargo system.

MALONE

CHANGING THE WAY YOU GET THERE

Limited Lifetime Warranty

The Malone Auto Racks (Malone) Limited Lifetime Warranty covers certain Malone-brand products that have been specifically identified for inclusion in the program and is effective for as long as the original retail purchaser owns the product. This warranty is terminated when the original retail purchaser sells or otherwise transfers the product to any other person or entity.

Subject to the limitations and exclusions described in this warranty, Malone will remedy defects in materials and/or workmanship by repairing or replacing, at its option, a defective product without charge for parts or labor. Malone may elect, at its option, not to repair or replace a defective product but rather issue to the original retail purchaser a refund equal to the purchase price paid for the product, or credit to be used toward the purchase of a replacement Malone product.

This warranty does not cover, and no warranty is given for defects or problems caused by normal wear and tear, which includes, but is not limited to, surface (aesthetic) metal corrosion, scratches, dents, deformities, accidents, unlawful vehicle operation, or any modification of a product not performed or authorized in writing by Malone.

In addition, this warranty does not cover problems resulting from conditions beyond Malone's control including, but not limited to, theft, misuse, overloading, or failure to assemble, mount or use the product in accordance with Malone's written instructions or guidelines included with the product provided to the original retail purchaser.

No warranty is given for Malone products purchased outside of the continental United States, Canada and Mexico.

If the product is believed to be defective, the original retail purchaser should contact the Malone dealer from whom it was purchased, who will give the original retail purchaser instructions on how to proceed. If the original retail purchaser is unable to contact the Malone dealer, or the dealer is not able to remedy the defect, the original retail purchaser should contact Malone by email at support@maloneautoracks.com.

In the event that the product must be returned to Malone, a technician at the email address above will provide the original purchaser with return shipping instructions. The original purchaser will be responsible for the cost of mailing the product to Malone. In order to be eligible to receive any remedy under this warranty, a copy of the original purchase receipt, a description of the defect and a return address must be provided.

Disclaimer of Liability

Repair or replacement of a defective product, or the issue of a refund or credit (as determined by Malone) is the original retail purchaser's sole and exclusive remedy under this warranty. Damage to original purchaser's vehicle, cargo, or property, and/ or to any other person or property is not covered by this warranty.

This warranty is expressly made in lieu of any and all other warranties, express or implied, including the warranties of merchantability and fitness of a particular purpose

Malone's sole liability to any purchaser is limited to the remedy set forth above. In no event will Malone be liable for any direct, indirect, consequential, incidental, special, exemplary, or punitive damages , or, for any other damages of any kind or nature (including but not limited to, lost profits, lost income or lost sales).

Some states do not allow the exclusion or limitation of incidental or consequential damages, so the above limitations may not be applicable.

In addition, all vehicular transports are potentially hazardous. Any person(s) using Malone products are personally responsible for following the given directions for use and/or installation and accepts full responsibility for any and all damages or injury of any kind including death, which may result from their use and/or installation.

MALONE AUTO RACKS 81 County Rd. Ste 1, Westbrook, ME 04092
P: 207.774.9100 F: 207.615.0551
E: support@maloneautoracks.com W: www.maloneautoracks.com

MALONE

CHANGING THE WAY YOU GET THERE

Garantie à vie limitée

La garantie à vie limitée de Malone Auto Racks (Malone) couvre certains produits de marque Malone expressément désignés pour être inclus dans ce programme et est valide tant que l'acheteur original est propriétaire du produit. Cette garantie prend fin lorsque l'acheteur original vend ou cède le produit à une autre personne ou entité.

Sous réserve des restrictions et exclusions prévues dans la garantie, Malone corrigera toute défectuosité matérielle et/ou tout défaut de fabrication en réparant ou en remplaçant, à sa discrétion, un produit défectueux sans frais pour ce qui est des pièces et de la main-d'oeuvre. Malone peut décider, à son choix, de ne pas réparer ou remplacer un produit défectueux, mais plutôt d'accorder à l'acheteur original un remboursement d'un montant égal au prix d'achat pour le produit ou encore un crédit pour l'achat d'un produit de remplacement de marque Malone.

La présente garantie ne couvre pas les défauts et les problèmes résultant d'une usure normale et aucune garantie n'est offerte à cet égard, notamment en cas de corrosion du métal en surface (esthétique), d'égratignures, de bosses, de déformations, d'accident, d'une utilisation illégale du véhicule ou de toute modification du produit qui n'est pas effectuée ou autorisée par écrit par Malone.

En outre, la garantie ne couvre pas les problèmes résultant de circonstances échappant au contrôle de Malone, y compris, notamment, résultant d'un vol, d'un usage abusif ou d'une surcharge ou encore d'un assemblage, d'une installation ou d'une utilisation du produit ne respectant pas les instructions écrites de Malone fournies à l'achat à l'acheteur original.

Aucune garantie n'est offerte pour des produits Malone achetés à l'extérieur du territoire continental des États-Unis, du Canada ou du Mexique.

Si le produit semble défectueux, l'acheteur original doit contacter le détaillant Malone où il a fait son achat et celui-ci lui fournira des renseignements sur la démarche à suivre. Si l'acheteur original ne réussit pas à contacter le détaillant Malone ou encore si le détaillant est incapable de remédier à la défectuosité, l'acheteur original doit communiquer directement avec Malone par courriel à l'adresse suivante : support@maloneautoracks.com.

Dans le cas où le produit doit être retourné à Malone, un technicien contacté à l'adresse courriel ci-dessus fournira à l'acheteur original les instructions à suivre pour l'expédition du produit. L'acheteur original devra assumer les frais d'expédition à Malone. Pour qu'une demande soit admissible aux termes de la présente garantie, il faut envoyer à Malone une copie du reçu de l'acheteur original, une description de la défectuosité et une adresse de retour.

Exonération de responsabilité

La réparation ou le remplacement du produit défectueux ou encore la remise d'un remboursement ou d'un crédit (tel que déterminé par Malone) constitue le seul et exclusif dédommagement offert à l'acheteur original aux termes de la présente garantie. Les dommages causés au véhicule de l'acheteur original, à un chargement, à ses biens et/ou à toute autre personne ou tout autre bien ne sont pas couverts par cette garantie.

Cette garantie est octroyée expressément afin de remplacer toute autre garantie expresse ou implicite, y compris toute garantie de qualité marchande ou de conformité pour un usage particulier.

L'unique responsabilité de Malone envers l'acheteur se limite aux dédommagements indiqués ci-dessus. Malone ne pourra en aucun cas être tenu responsable des dommages directs, indirects, consécutifs, spéciaux, exemplaires ou punitifs ou de tout autre dommage de quelque nature que ce soit (y compris notamment une perte de profits, de revenus ou de ventes).

L'exclusion ou la limitation des dommages indirects ou consécutifs n'étant pas permise à certains endroits, les limitations indiquées ci-dessus peuvent ne pas s'appliquer.

En outre, tous les transports par véhicule comportent des risques potentiels. Toute personne utilisant un produit Malone est donc personnellement responsable de suivre les instructions fournies pour son utilisation et/ou son installation et accepte l'entière responsabilité pour tout dommage ou toute blessure de quelque nature que ce soit, y compris un décès, pouvant résulter de son utilisation et/ou son installation.

MALONE AUTO RACKS 81 County Rd. Ste 1, Westbrook, ME 04092

P: 207.774.9100 F: 207.615.0551

E: support@maloneautoracks.com W: www.maloneautoracks.com