



OWNER'S MANUAL

RAFTS, CATARAFTS, INFLATABLE KAYAKS



www.aire.com
844.243.2473

WELCOME



CAUTION

Congratulations on your new AIREcraft! Welcome to the river community. We hope your new raft, cataraft, or inflatable kayak takes you to new and wild places. AIRE inflatables are the result of extensive design, field-testing, and USA manufacturing. Our unique AIREcell system is made with an airtight bladder wrapped in a puncture and wear-resistant outer shell. This makes your boat durable, safe, and easy to repair so you enjoy more time on the water.

TABLE OF CONTENTS

| | |
|--------------------------------|----|
| SAFETY WARNING: | 1 |
| RAFTS..... | 2 |
| CATARAFTS | 12 |
| KAYAKS | 18 |
| CARE & MAINTENANCE | 26 |
| REPAIR | 30 |
| RETURNS..... | 38 |
| AUTHORIZED SERVICE CENTER..... | 38 |
| WARRANTY | 39 |
| NOTES | 40 |

SAFETY WARNING:

Paddlesports can be very dangerous and physically demanding. The user of the product should understand that participating in paddlesports might involve serious injury or death. Observe the following safety standards whenever using this product:

- **ALWAYS WEAR A COAST GUARD APPROVED FLOTATION DEVICE WHEN PARTICIPATING IN PADDLESPORTS.**
- Get paddlesports instruction specific to this type of craft.
- Obtain certified first aid training and carry first aid and rescue / safety equipment.
- Dress appropriately for weather conditions; cold water and/or cold weather can result in hypothermia.
- Check your equipment prior to each use for signs of wear or failure.
- Never paddle alone.
- Do not paddle in flood conditions.
- Be aware of appropriate river water levels, tidal changes, dangerous currents, and weather changes.
- Scout unfamiliar waters, portage where appropriate.
- Do not exceed your paddling ability; be honest with yourself.
- Consult your physician prior to beginning your paddlesports training.
- Follow the manufacturer's recommendations for the use of this product.

THE USE OF THIS PRODUCT ACKNOWLEDGES BOTH AN UNDERSTANDING AND AN ASSUMPTION OF THE RISK INVOLVED IN PADDLESPORTS.

RAFTS

RAFTS

ANATOMY OF A RAFT

Your new AIRE raft is constructed using top quality materials and is manufactured in the USA at our Meridian, Idaho, factory. All AIRE boats are built using our unique AIREcell system. This system allows us to weld seams and manufacture without using solvents or adhesives that can break down over time. AIRE rafts are built using multiple components that can be repaired or replaced which can extend the life of your raft.

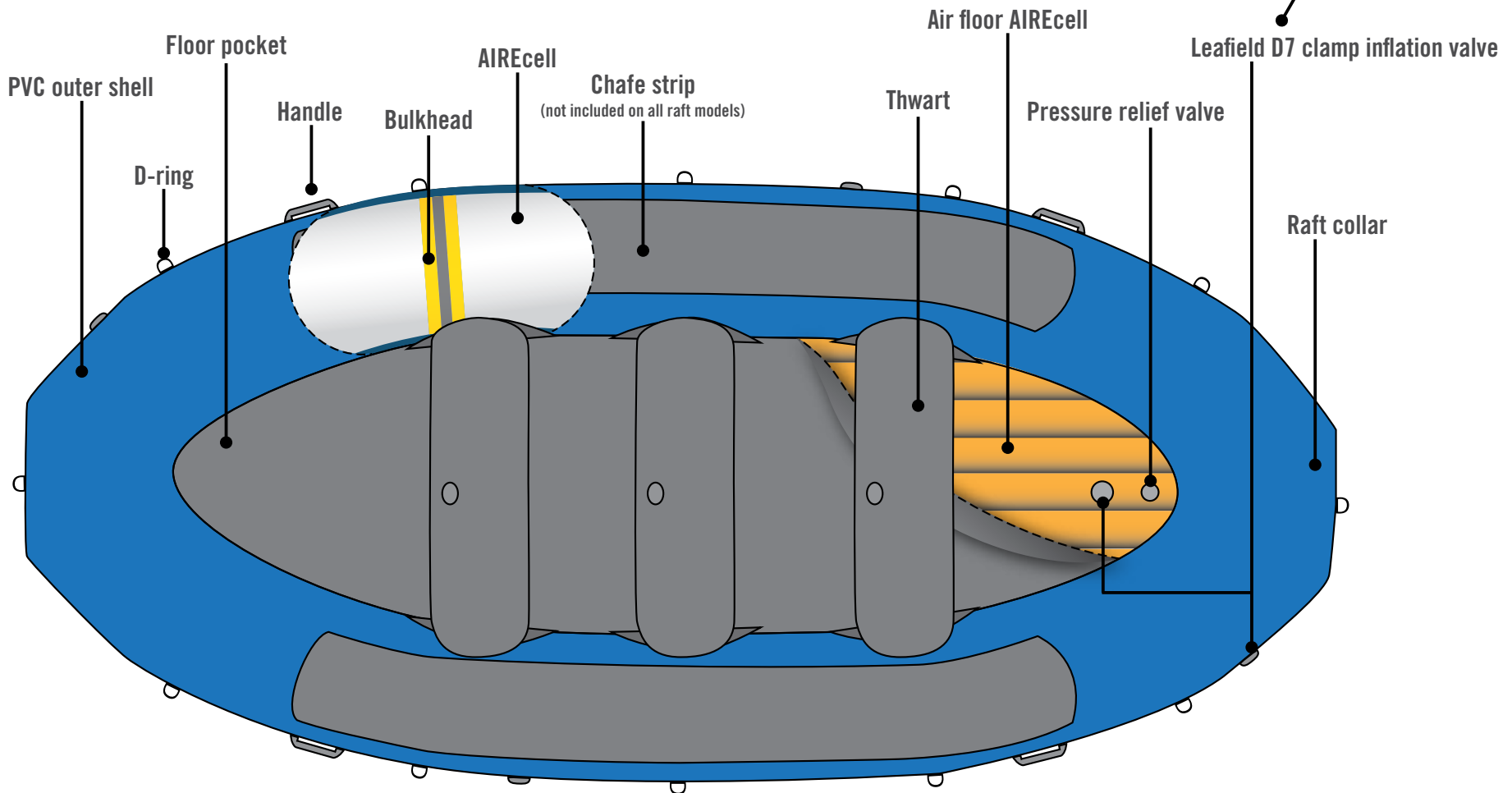
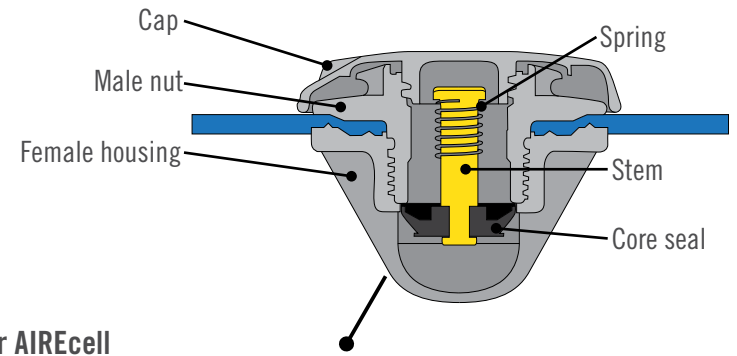

RAFTS

RAFT FLOOR INSTALLATION

Instructions also available on YouTube
<https://www.youtube.com/watch?v=oNyH-S9uXhE>



scan code with
smart phone

Tools you will need:

- Lacing rope (included with raft)
 - 2 pieces of cardboard
 - Lighter or torch
 - Bucket of dish soap mixed with warm water
 - Scissors
1. Inflate the raft and the floor to soft pressure (Inflation, page 9), just enough to hold shape. Flip the raft collar upside-down.
 2. Run three long cam straps all the way around the raft collar – one at the center, one at the bow, and one at the stern. This will create a cradle for the floor to rest on and helps keep the floor in position while you lace it in.
 3. The bow of the raft collar has a built-in splash guard. On symmetrical boats you can determine which end of the raft you would prefer the floor valve. Place the floor in the cam strap cradle. **Be sure the drain holes in the floor are facing up toward the bottom of the raft.**
 4. Heat the ends of the lacing ropes with a small torch or lighter to melt about 4"–5". Roll the ends of the rope between two pieces of cardboard to create a stiff "needle." This will make the rope ends ridge and easy to thread through the lacing loops.
 5. Tie a slipknot in the center of each rope.
 6. Soak the ropes (except the "needle" ends) in soapy water for about five minutes to help reduce friction.
 7. Align the floor and the collar by the center deep-cut lacing notch found on both sides of the raft and floor pocket. On some raft models there are two deep-cut notches found around the center loop.

RAFTS

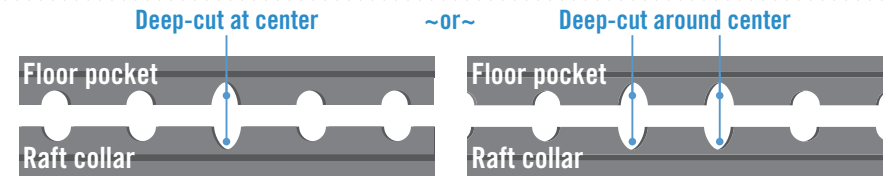

8. Start lacing rope #1 in this deep-cut center notch. The knot will prevent you from pulling all the rope through.
9. Alternate the rope from the collar to the floor; the pattern is every other lace loop in both the floor and the collar.

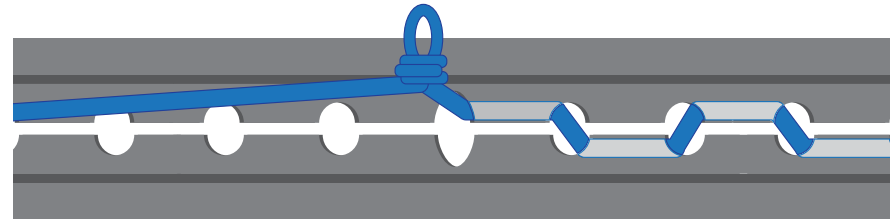

10. Every four or five loops, snug up the rope. When pulling the slack tight, **PULL PARALLEL** with the lace loops and never at an angle, because the friction from the rope can damage the loops.
11. Go half way around the raft to the other deep-cut lacing notch.
12. **Go back to the start of rope #1** and untie the slipknot; continue the same pattern around the other side of the raft. Check that no loops were skipped.
13. With the first rope done, tie a series of square knots, trim the ends, and burn the ends together (being careful not to burn your raft). Tuck the knots under the lacing so the knots are on the inside of the floor and not exposed to the bottom of the raft.
14. With lacing rope #2, start on the side you finished lacing rope #1 and repeat steps 6–11, lacing through the opposite loops.

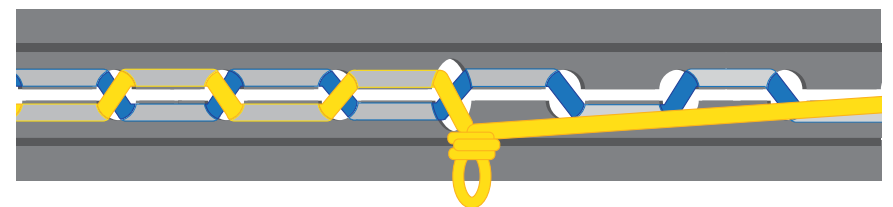

RAFT FLOOR INSTALLATION DIAGRAM

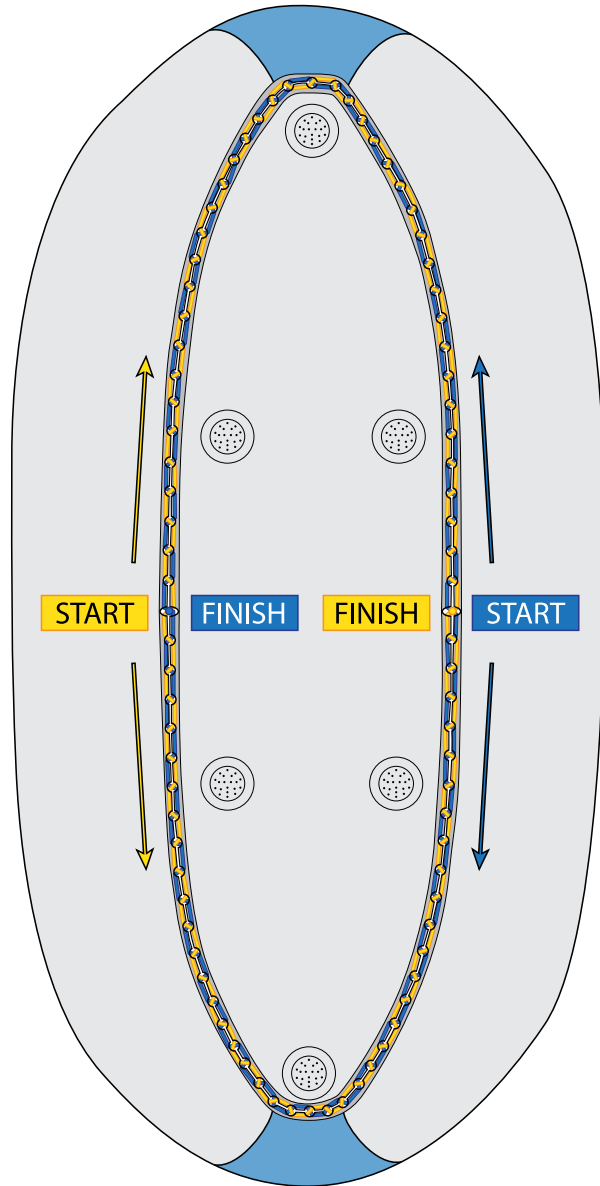

RAFT THWART INSTALLATION

Instructions also available on YouTube
<https://www.youtube.com/watch?v=bptnJW43G7U>



scan code with
smart phone

Tools you will need:

- Thwarts
 - 3' cam strap pack (comes with thwarts)
 - Needle-nose pliers
1. Lay the thwarts on raft where you would like them to be, with all the valves facing the back of the raft.
 2. D-rings remain on the inside flap of the thwart to protect the collar of the raft from the cam strap buckle.
 3. Each thwart spans seven lacing loops.
 4. Thread the cam strap through the bottom D-ring, then through the back of the cam buckle, and again through the D-ring.

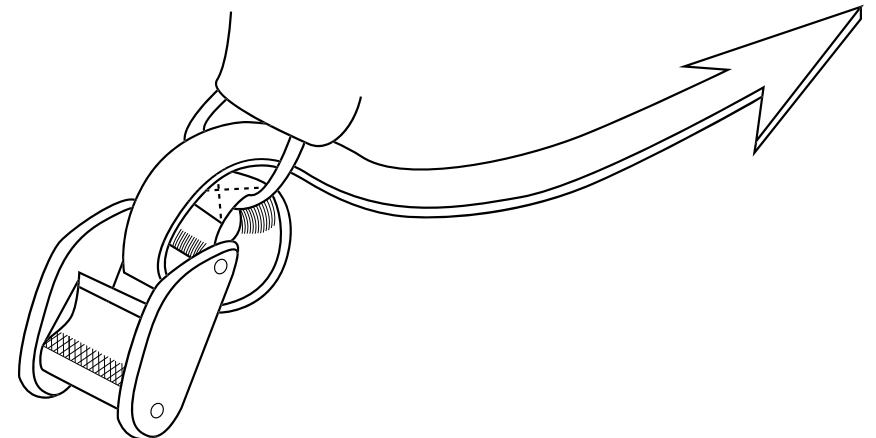

RAFT THWART INSTALLATION

Thwart Installation—Quick Method: If you take the thwarts in and out of the raft.

1. Leave D-rings inside the protective cover.
2. Thread the cam strap through the **bottom** D-ring, then the back of the cam buckle, and again through the D-ring.
3. Thread the cam strap through the **top** D-ring, the first lacing loop, and back through the cam buckle. If needed, use needle-nose pliers to help guide the strap through the lace loops.
4. Repeat on all sides of the thwart.

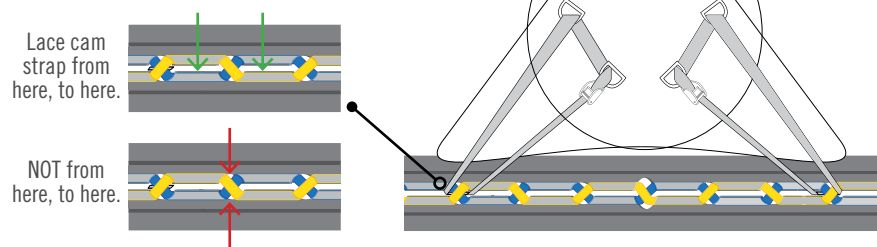

Thwart Installation—Permanent Method: If you use your boat mostly as a paddle raft.

1. Leave D-rings inside the protective cover.
2. Thread the cam strap through the **bottom** D-ring, then the back of the cam buckle, and again through the D-ring.
3. Thread the cam strap through the **third** lacing loop and up through the **top** D-ring. If needed, use needle-nose pliers to help guide the strap through the lace loops.
4. Thread the cam strap through the **first** lacing loop and back through the cam buckle.
5. Repeat on all sides of the thwart.

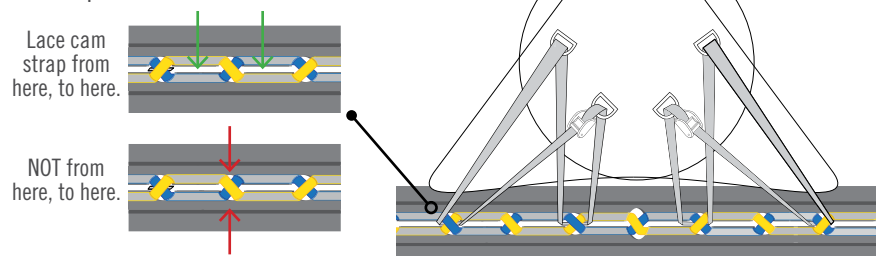

RAFT INFLATION

Instructions also available on YouTube

<https://www.youtube.com/watch?v=bj0jS6eV5xA>



scan code with
smart phone

1. Turn the valve stem a quarter turn clockwise to position the stem in the up, or closed position. This will allow air to enter the chamber, but won't allow air to escape.
2. Inflation sequence will be in a cross pattern. This helps keep the AIRE cells in their proper place.
3. Start with an electric pump if you have one or use a hand pump, inflating each chamber to a soft pressure. You will notice the AIRE cell will expand past the line of the bulkhead. The cell will push back and pressurize as the adjoining cell is inflated.
4. Top off each chamber in the same pattern. If you hear a humming sound in the floor valve, it's the pressure release indicating the floor has reached maximum pressure (2.5 psi) and you can stop pumping. For the other chambers, using your thumb you should be able to depress about 1/2" from the top center of the tube.
5. Close valve caps finger tight.

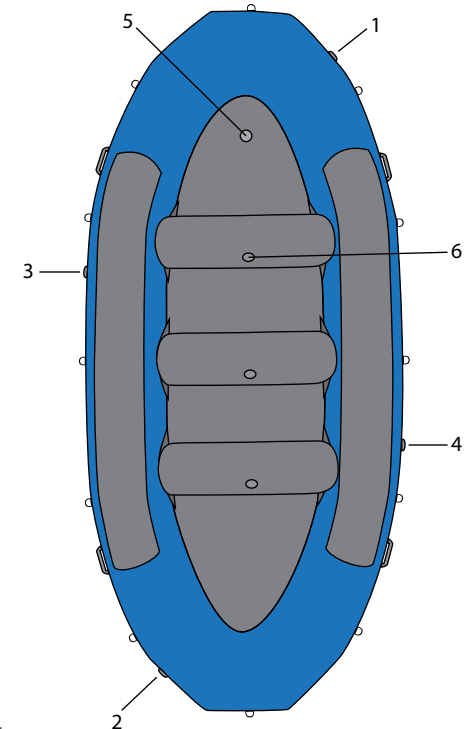

RAFT DEFLATION & ROLLING

1. When the raft is completely dry, deflate it flat on a clean, non-abrasive surface by opening the valve caps and depressing the valve stem. Twist the valve stem a quarter turn counterclockwise to lock the valve stem down and open. Air should be able to escape unimpeded.
2. DO NOT deflate your raft on its side as this could cause the AIREcells inside to misalign.
3. Grab one side of the raft collar, holding enough fabric to pinch the AIREcell inside, and fold it over. The floor lacing should be the edge of the fold.

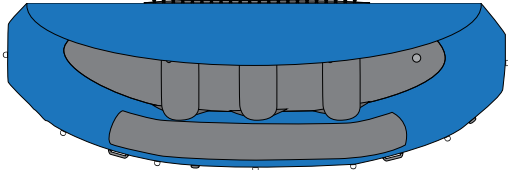

4. Repeat on the other side of the raft collar.

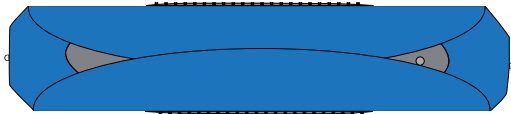

5. Roll the raft towards the floor valve and wrap it with a strap to secure.

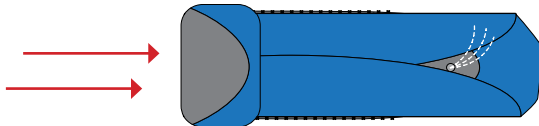

6. If there is some residual moisture in the floor pocket, it will continue to drain if the boat is set on its side with the lace loop down.

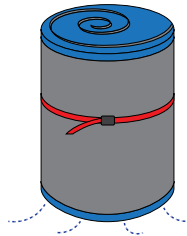

7. Store your boat in an AIRE raft bag, heavy tarp, or cloth.

RAFT STORAGE TIPS:

We encourage you to go boating year-round, but if you need to store your boat here are a few helpful tips:

- It is best to store your raft inflated to soft pressure under a cover or car port that provides protection from environmental elements. This will help prevent weather and UV damage and will keep your AIREcells aligned.
- If you plan to deflate and roll your raft for storage, first allow it to air dry for 24–48 hours.
- Do not stack or load other gear or equipment on top of your rolled raft.
- Treat the folded and rolled corners of the raft with care, as these areas are susceptible to damage when being dragged or moved around on concrete or gravel.
- Keep away from heat sources such as open flames, furnaces, and water heaters.
- Store in a cool and dry place protected from UV light.
- Store your boat in an AIRE raft bag, heavy tarp, or cloth.
- Store inside or up off the ground to keep it away from mice.

RAFT TRANSPORTATION TIPS:



Valve caps should always be in place whenever transporting your boat.

TRANSPORTING YOUR RAFT DEFLATED AND ROLLED:

Wrap the boat in an AIRE raft bag, heavy tarp, or cloth. Do not load other equipment on top of the raft that could potentially cause damage.

TRANSPORTING YOUR RAFT ON A TRAILER:

- Inspect the trailer for rough or sharp areas that can damage the boat.
- If your raft has a frame, strap the frame, not the D-rings, down to the trailer.
- If you are paddle boating (no frame), run straps over the raft or stack of rafts, going under lifelines or through D-rings. Put a bow line down to the trailer.
- Be careful not to rope-burn the boat by rapidly pulling lines or straps that are tight against the raft.
- Air temperature or changes in elevation can increase the air pressure inside your raft dramatically, which may cause an AIREcell to burst. Release some air pressure if these conditions occur.
- When stacking framed boats, remove or pad the oarlocks.
- Tie up loose strap ends so they don't wind-whip the raft.
- Do not overload a trailered raft, especially upper rafts in a stack.

CATARAFTS

ANATOMY OF A CATARAFT

Your new AIRE cataraft is constructed using top quality materials and is manufactured in the USA at our Meridian, Idaho, factory. All AIRE boats are built using our unique AIREcell system. This system allows us to weld seams and manufacture without using solvents or adhesives that can break down over time. AIRE catarafts are built using multiple components that can be repaired or replaced which can extend the life of your cataraft.

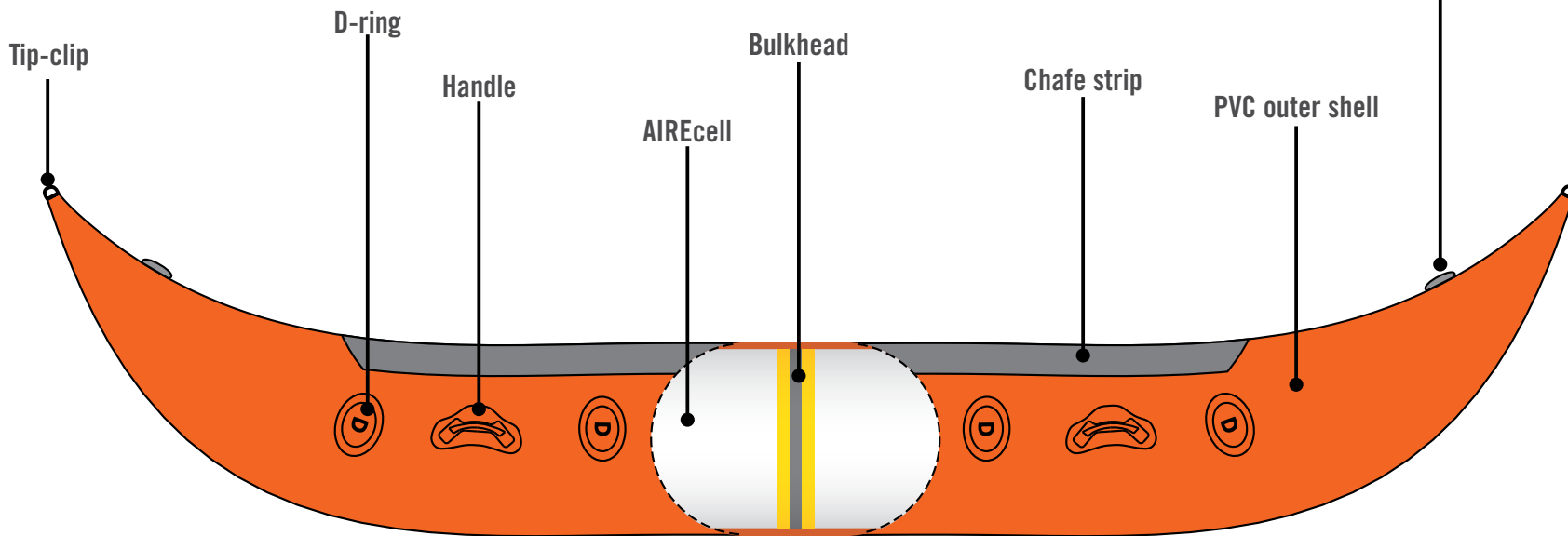

CATARAFTS

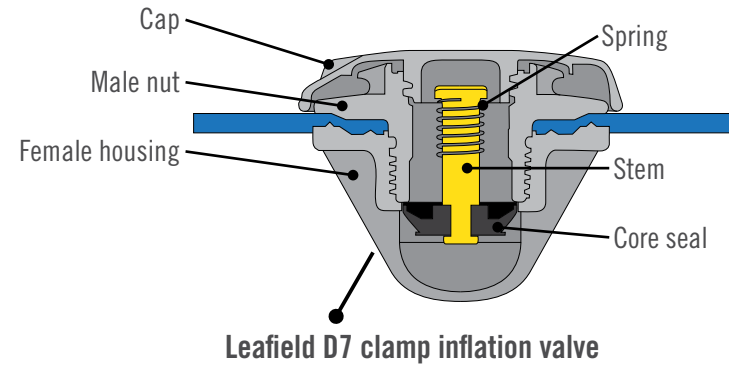

CATARAFTS

CATARAFT INFLATION

Instructions also available on YouTube
<https://www.youtube.com/watch?v=3FMXvDzkb-c>



scan code with
smart phone

1. Roll out both tubes completely.
2. Turn the valve stem a quarter turn clockwise to position the stem in the up, or closed, position. This will allow air to enter the chamber, but won't allow air to escape.

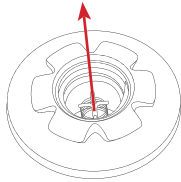

3. Using an electric or hand pump, inflate each chamber to soft pressure. Then, following the same order, inflate to full running pressure (2.5psi). This helps prevent damage to the AIREcells.

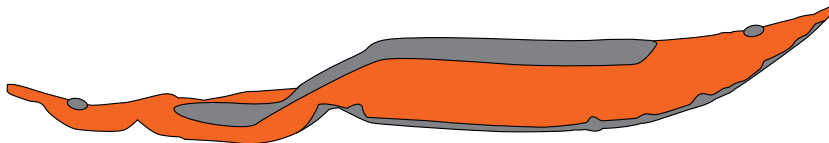

4. Top off each chamber to recommended 2.5 psi with a hand pump. Check your pressure by depressing the tube with your thumb; properly inflated tubes will depress 1/2" from top center of the tube.

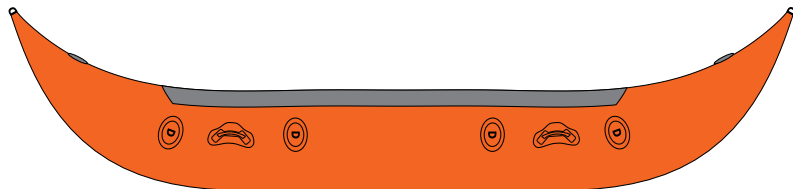

5. Close valve caps finger tight.

CATARAFTS

CATARAFT FRAME INSTALLATION

1. Place the tubes on a non-abrasive surface, approximately as far apart as the width of frame.
2. Gently set the frame on top of one tube while rolling the tube so the chafe strip is facing up. It is best to do this step with a partner.
3. Using 1" cam straps, loosely attach the frame to at least one inside and one outside D-ring to keep the tube from rolling while working on the other tube.

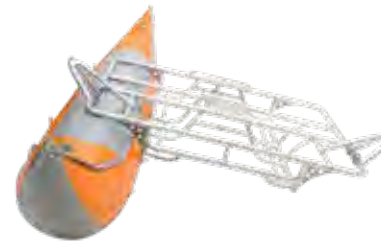

4. Repeat steps 2–3 with the other tube.
5. Adjust the frame to sit evenly on both tubes. Check forward and back position, as well as tube rotation. The side rails of the frame should not extend past the end of the chafe strip, and the center of the chafe strip should be top dead center of the tube.
6. LOOSELY attach the frame to the rest of the D-rings. It is recommended that you attach the frame to each tube with eight D-rings, four on both the inside and outside of each tube. Do your best to get fore and aft tension with the straps to help keep the frame from shifting.



7. Be sure to top off the tubes before cinching down all straps. Tightening straps before you top off the tubes can result in damage to the D-rings.

Crinkled, pulling the D-ring too tight.



CATARAFTS

CATARAFT DEFLATION & ROLLING

1. When the boat is completely dry, detach the frame from the tubes and remove all straps from D-rings.
2. Set one tube, with valves facing up, on a clean, non-abrasive surface.
3. Deflate the tube flat by opening the valve caps and depressing the valve stem. Twist the valve stem a quarter turn counterclockwise to lock the valve stem down and open. Air should be able to escape unimpeded.
4. Lay the other tube on top of the first and repeat step 3. Allow the weight of the tubes to collapse all of the air out.

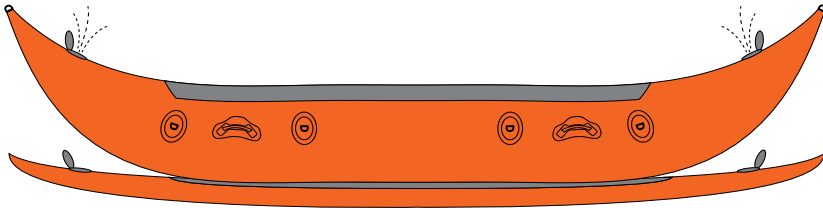

5. Fold the deflated cataraft tube in half so all the valves are on the same side.

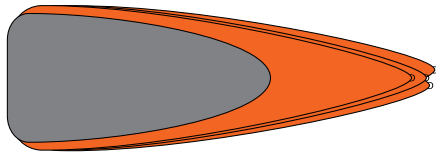

6. Roll both tubes together toward the valves. Be sure to keep the valves open with valve caps set to the side of the valve so that the air can escape while rolling.

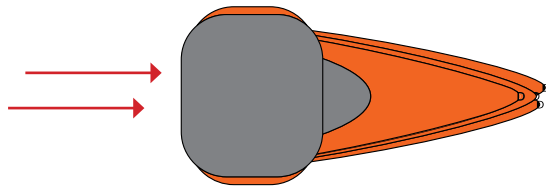

7. Tie your rolled cataraft together with a length of rope or a cam buckle strap threaded through the two D-rings on the tip-clips and around the rest of the boat.
8. Store your boat in an AIRE raft bag, heavy tarp, or cloth.

CATARAFTS

CATARAFT STORAGE TIPS:

We encourage you to go boating year-round, but if you need to store your cataraft here are a few helpful tips:

- It is best to store your cataraft inflated to soft pressure under a cover or car port that provides protection from environmental elements. This will help prevent weather and UV damage and will keep the AIREcells aligned.
- If you plan to deflate and roll your cataraft for storage, first allow it to air dry 24–48 hours.
- Do not stack or load other gear or equipment on top of your rolled cataraft.
- Treat folded and rolled corners of the cataraft with care, as these areas are susceptible to damage when being dragged or moved around on concrete or gravel.
- Keep away from heat sources such as open flames, furnaces, and water heaters.
- Store in a cool and dry place protected from UV light.
- Store your boat in an AIRE raft bag, heavy tarp, or cloth.
- Store inside or up off the ground to keep it away from mice.

CATARAFT TRANSPORTATION TIPS:



Valve caps should always be in place whenever transporting your boat.

TRANSPORTING YOUR CATARAFT DEFLATED AND ROLLED:

Wrap the boat in an AIRE raft bag, heavy tarp, or cloth. Do not load other equipment on top of the cataraft that could potentially cause damage.

TRANSPORTING YOUR CATARAFT ON A TRAILER:

- Inspect the trailer for rough or sharp areas that can damage the boat.
- Strap the frame, not the D-rings, down to the trailer.
- Be careful not to rope-burn the boat by rapidly pulling lines or straps that are tight against the cataraft.
- Air temperature or changes in elevation can increase the air pressure inside the cataraft dramatically, which may cause an AIREcell to burst. Release some air pressure if these conditions occur.
- When stacking framed boats, remove or pad the oarlocks.
- Tie up loose strap ends so they don't wind-whip the cataraft.
- Do not overload a trailered cataraft, especially upper boats in a stack.

ANATOMY OF AN INFLATABLE KAYAK

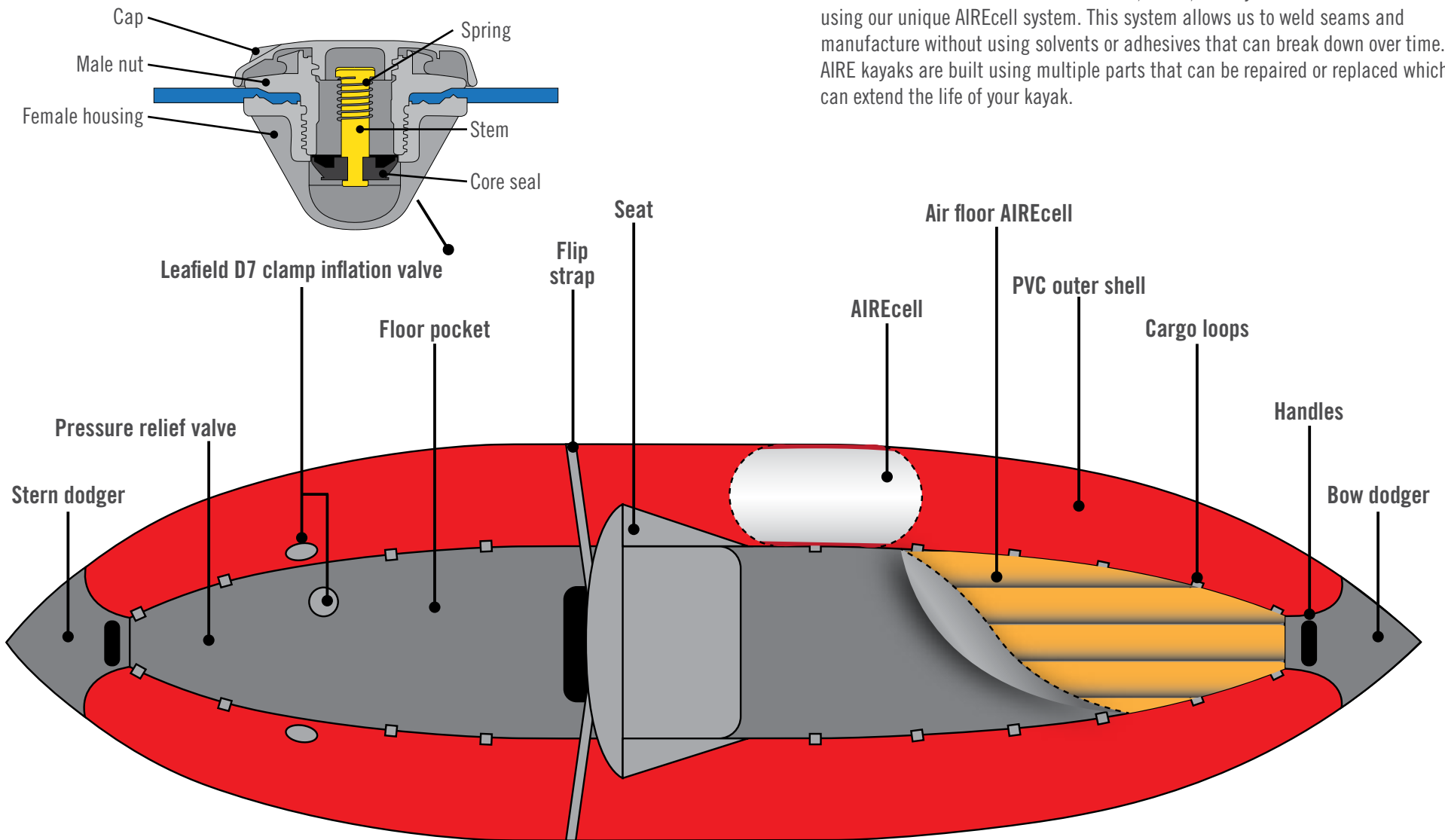

Your new AIRE kayak is constructed using top quality materials and is manufactured in the USA at our Meridian, Idaho, factory. All AIRE boats are built using our unique AIREcell system. This system allows us to weld seams and manufacture without using solvents or adhesives that can break down over time. AIRE kayaks are built using multiple parts that can be repaired or replaced which can extend the life of your kayak.

KAYAKS

KAYAK SEAT INSTALLATION

Instructions also available on YouTube
<https://www.youtube.com/watch?v=xm7PMvZnH6Q>



scan code with
smart phone

1. Choose where you would like the seat to be positioned in the kayak. Centered, or a little back from center, is recommended.
2. The seat spans five cargo loops.
3. Undo the strap around the male side release buckle and thread it through the cargo loop.
4. Re-attach the strap to the male side release buckle by going up through the front buckle slit, and down through the back buckle slit.
5. Attach the male side release buckle on the strap to the female side release buckle on the seat.
6. Repeat 3–5 on the remaining straps.
7. Pull the straps tight.

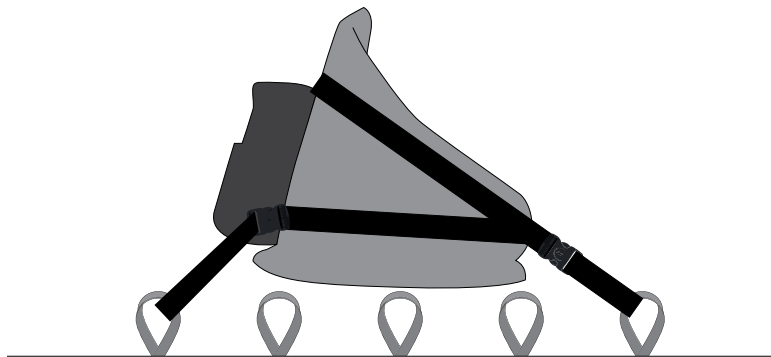
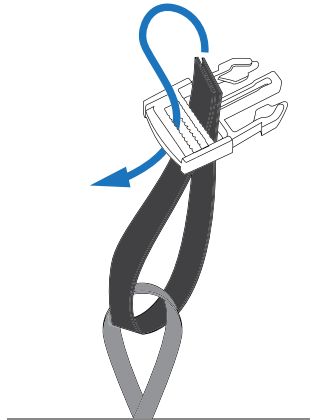

KAYAKS

KAYAK SEAT INSTALLATION

8. The flip strap is designed to go all the way around the kayak to help flip the kayak back over if it becomes capsized.

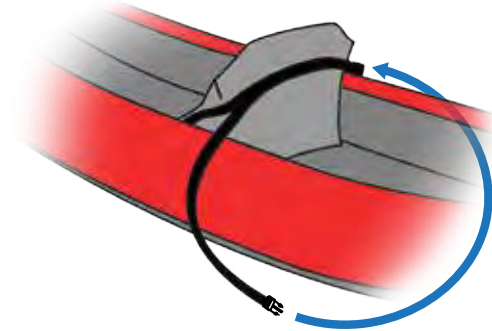

FORCE COCKPIT

The Force kayak has an adjustable cockpit instead of a seat. To adjust the cockpit for proper fit, follow these instructions.

1. Flip out the zippers tucked between the bow and stern bag covers and the bow and stern bags.
2. Unzip the zipper to access the bow and stern bags.
3. Adjust the bow and stern bags by moving the bag straps along the internal cargo loops.
4. Tighten the straps.
5. Inflate the Force and check the fit before going out on the water.

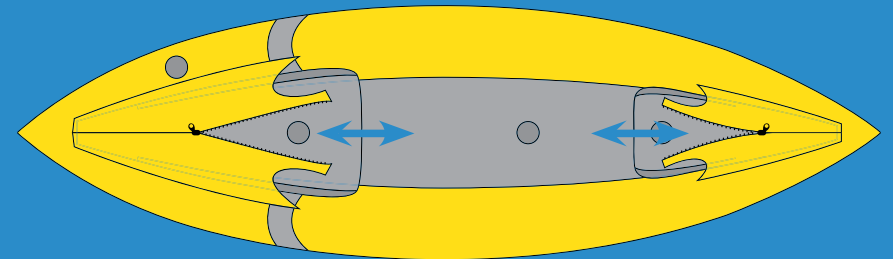

KAYAKS

KAYAK INFLATION

Instructions also available on YouTube
<https://www.youtube.com/watch?v=GAluuoAd87A>



scan code with
smart phone

1. Roll out the kayak completely.
2. Turn the valve stem a quarter turn clockwise to position the stem in the up, or closed, position. This will allow air to enter the chamber, but won't allow air to escape.

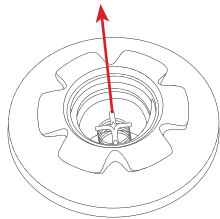

3. Using an electric or hand pump, inflate the side chambers to soft pressure and inflate the floor to soft pressure. This sequence helps keep the floor AIREcell in place.
4. Top off each chamber in the same pattern. If you hear a humming sound in the floor valve, it's the pressure relief valve indicating the floor has reached maximum pressure of 2.5 psi and you can stop pumping. For the other chambers, using your thumb you should be able to depress about 1/2" from the top center of the tube.
5. Close valve caps finger tight.

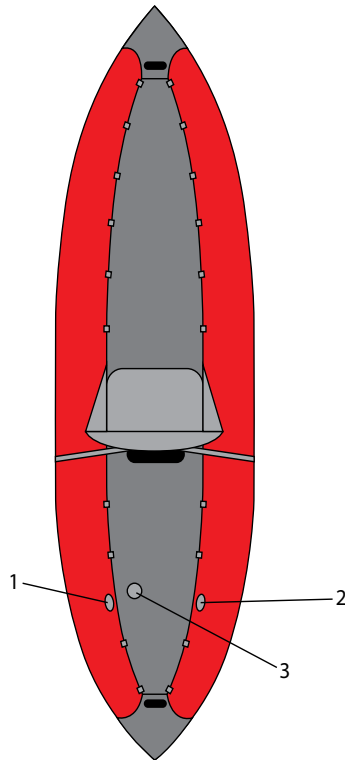

KAYAKS

KAYAK THIGH STRAP INSTALLATION

Instructions also available on YouTube
https://www.youtube.com/watch?v=UNqDqgT_K4w



scan code with
smart phone

Thigh straps come standard with the Force kayak and are a recommended accessory for all other AIRE inflatable kayaks. Thigh straps help provide more control of your boat.

1. Thigh straps should be installed with the larger end of the knee pad at your thigh and the smaller end toward your feet, with the curve of the strap pointing toward the inside of the kayak.
2. Attach the back strap to the cargo loop behind the seat by pushing the thigh strap loop through the cargo loop and threading the end of the strap back through the thigh strap loop.
3. Thread the end of the strap through the hole in the seat and attach it to the cam buckle on the thigh end of the knee pad.
4. Attach the other end of the knee pad by threading the strap through a cargo loop, about half way down the front strap.
5. Pull the strap through the cargo loop and attach the strap to the cam buckle.
6. Repeat steps 1–5 on the other strap.
7. Sit in the seat and adjust the straps to your desired fit and comfort by pulling the straps through the cam buckles on both ends of the knee pad.

* NEVER WRAP THE THIGH STRAP AROUND YOUR LEG OR "SEAT BELT" YOURSELF INTO THE KAYAK.

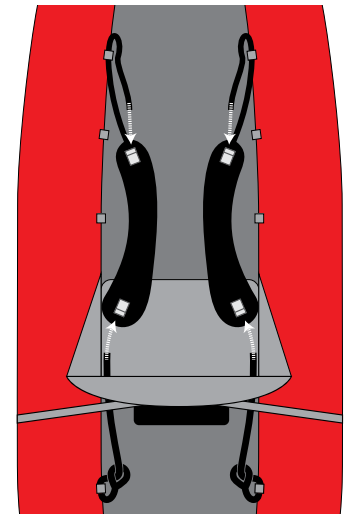

KAYAKS

KAYAK DEFLATION & ROLLING

1. When the kayak is completely dry, deflate it flat on a clean, non-abrasive surface by opening the valve caps and depressing the valve stem. Twist the valve stem a quarter turn counterclockwise to lock the valve stem down and open. Air should be able to escape unimpeded.
2. DO NOT deflate your kayak on its side as this could cause the AIREcells inside to misalign.

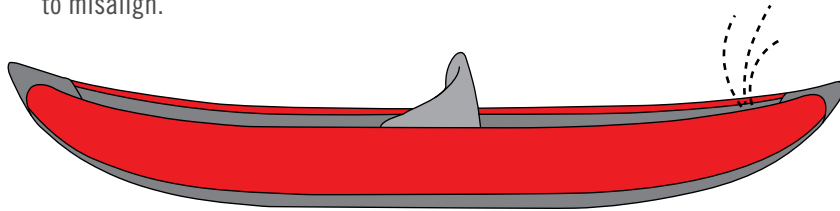

3. Fold the kayak seat down.
4. Roll the kayak toward the floor valve and wrap it with a strap to secure.

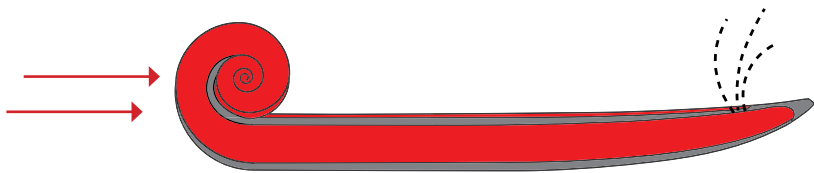

5. If there is some residual moisture in the floor pocket it will continue to drain if the boat is set on its side.
6. Store your boat in an AIRE kayak bag, heavy tarp, or cloth.

KAYAKS

KAYAK STORAGE TIPS:

We encourage you to go boating year-round, but if you need to store your kayak here are a few helpful tips:

- It is best to store your kayak inflated to soft pressure under a cover or car port that provides protection from environmental elements. This will help prevent weather and UV damage and will keep the AIREcells aligned.
- If you plan to deflate and roll your kayak for storage, first allow it to air dry 24–48 hours.
- Do not stack or load other gear or equipment on top of your rolled kayak.
- Treat folded and rolled corners of the kayak with care, as these areas are susceptible to damage when being dragged or moved around on concrete or gravel.
- Keep away from heat sources such as open flames, furnaces, and water heaters.
- Store in a cool and dry place protected from UV light.
- Store your boat in an AIRE kayak bag, heavy tarp, or cloth.
- Store inside or up off the ground to keep it away from mice.

KAYAK TRANSPORTATION TIPS:



Valve caps should always be in place whenever transporting your boat.

TRANSPORTING YOUR KAYAK DEFLATED AND ROLLED:

Wrap the boat in an AIRE kayak bag, heavy tarp, or cloth. Be sure not to load other equipment on top of the kayak that could potentially cause damage.

CAR TOPPING YOUR KAYAK:

- Inspect the car top for rough or sharp areas that can damage the boat.
- Strap the inflated kayak to the top of the car rack with the floor bottom up and the cockpit down. Make sure it is secure before driving.
- Be careful not to rope-burn the boat by rapidly pulling lines or straps that are tight against the kayak.
- Air temperature or changes in elevation can increase the air pressure inside the kayak dramatically, which may cause an AIREcell to burst. Release some air pressure if these conditions occur.
- Tie up loose strap ends so they don't wind-whip the kayak.

CARE & MAINTENANCE

PROTECTANTS & CLEANERS

Over-use, or in some cases, any use of certain protectants, can render your boat unrepairable for welding or glue repair without requiring aggressive buffing. Some can actually cause plasticizer migration out of the PVC material.



DO NOT USE:

- Anything containing silicones.
- Spray lubricants, such as WD-40.
- Greases, sealants, or any other form of lubricant on the valve or zipper.



OKAY TO USE:

- Dish soap
- 303 Aerospace Protectant, one or two times a year to protect against UV damage.

BOAT RAMPS

Many river access ramps are constructed with logs that create a slide down to the river. These ramps can cause damage to your boat, because the heat created by friction from sliding the boat on the logs can melt the PVC coating. When using these ramps, turn the boat at a slight angle to keep the tubes out of the grooves in the ramp and GO SLOW. Friction on boat ramps can cause more damage than normal river use.

FABRIC MARBLING

PVC is manufactured on a roll and becomes folded and creased for the first time when the boat is packaged for storage and shipping. Brand new PVC will have white marks and indentations when you first un-box your boat giving it a marble look. Do not be alarmed! This is normal, does not affect the quality of the PVC, and will go away after it relaxes in sun light. For more information on fabric marbling please refer to our video.

Fabric marbling

<https://www.youtube.com/watch?v=a7dnEur6qgU>



scan code with
smart phone

CARE & MAINTENANCE

BOAT CLEANING

Instructions also available on YouTube

<https://www.youtube.com/watch?v=sYcZCbZxiaM>



scan code with
smart phone

Tools you will need:

- Blower or vacuum
- Dish soap mixed with warm water
- Sponge and/or soft bristle brush
- Towel

In order to protect your investment and prolong the life of your AIRE boat, we recommend a thorough cleaning each year at the end of the boating season.

1. Use a blower or vacuum to clean out all leaves and loose debris in the cockpit of your boat.
2. Scrub your boat with a sponge or soft bristled brush and warm soapy water. Do not use WD-40, Armor All, or any harsh astringent or chemical on any part of your boat as it may cause damage. Water that is hotter than 140° F can cause damage to the PVC and urethane used to build your AIRE boat.
3. Frame marks will be very difficult to remove. Don't worry, though, they won't damage your boat in any way and will most likely be covered up once you put the frame back on.
4. If you boat in silty or dirty waters, you may want to clean out the floor pocket. If you primarily recreate on clean waters, you should not be overly concerned with debris buildup inside the floor pocket and can skip steps 5–8.
5. To clean the floor pocket, deflate the collar and floor. Undo the split ring on the floor pocket zippers. If the zipper is jamming or not working properly, move on to the zipper maintenance guide on page 30 before proceeding with the rest of the cleaning.
6. Unzip the floor pocket halfway around the boat allowing you to work from one side. Keeping the AIREcell attached to the skin via the valve, fold over the floor top out of the way. Sweep, vacuum, or blow out any dirt or debris that may be inside the floor pocket.
7. Lay the AIREcell and floor top back in position and tuck the AIREcell under the zipper so that it clears the track of the zipper car.
8. Re-zip and lock the zipper cars together with the split ring. Inflate the floor to check for alignment issues, material bunching around the valve, or voids where the AIREcell is not filling out the pocket and adjust as necessary.
9. Wipe excess soap and water from boat and prop it on its side for 24–48 hours to allow complete drying before rolling or storing for extended periods of time.

CARE & MAINTENANCE

ZIPPER MAINTENANCE

Instructions also available on YouTube
<https://www.youtube.com/watch?v=fswyZeap9-M>



scan code with
smart phone

Tools you will need:

- Squirt bottle containing dish soap mixed with warm water
- Plastic bristle scrub brush
- Pliers if needed

Maintaining and cleaning the zippers once a year is a simple way to take care of your AIRE raft, cataraft, or kayak. A clean zipper will ensure easy access to the AIREcells.

1. Spray down a section of the zipper with the soapy water and scrub the teeth, removing any debris.
2. Repeat with the remaining sections of tube and floor zippers.
3. Remove split ring and undo zipper. The lubrication from the soapy water should facilitate this. DO NOT fully remove the zipper car from the zipper track.
4. Spray and scrub down each individual track from the inside.
5. On rafts and catarafts with double zippers, use the same process spraying and scrubbing down, cleaning both the internal and external tracks.
6. In older boats with stubborn zippers, pliers may be used to assist in opening and closing. Grasp the zipper car with the pliers and slowly push right in line with the zipper. Assist by pulling the zipper tab.
7. When cleaning is finished, close up the zippers. Use additional soapy water for lubrication if necessary.
8. Remember to replace the split rings.

CARE & MAINTENANCE

STOP AQUATIC HITCHHIKERS

AIRE encourages you to help stop the spread of Aquatic Invasive Species (AIS) such as Zebra and Quagga Mussels. According to Protect Your Waters (www.protectyourwaters.net): "AIS are organisms that are not native and cause significant harm to an ecosystem when introduced. Recreational boating can spread aquatic invasive species when species become attached to boats or survive in water carried on boats and are moved from one water to another. Invasive mussels can survive as larvae in just a small amount of water carried in a boat, and juveniles and adults can actually attach to the outside of a boat and move to a new location." This applies primarily to power-boats used in lakes. However, following these simple steps will help prevent the spread of AIS in rivers.

CLEAN

Remove all plants, animals, mud and thoroughly wash everything, especially all crevices and other hidden areas.

DRAIN

Eliminate all water before leaving the area. Let the raft floor drain completely.

DRY

Allow sufficient time for your boat to completely dry before launching in other waters.













Find out more about aquatic invasive species at www.protectyourwaters.net



STOP AQUATIC HITCHHIKERS!

THE REPAIR KIT

Each AIRE raft, cataraft, or kayak comes with a basic repair kit:

-  • **1 - Roll of fabric with PVC, AIREcell material, and air floor AIREcell material.** These can be used for stitched or glue repairs.
-  • **2 - Alcohol prep pads.** Used for cleaning the surface of PVC or AIREcell material before a patch.
-  • **1 - Piece of sand-paper.** Used to buff PVC material for a Tear-Aid patch or glue repair.
-  • **1 - Vinyl tube valve adapter.** This adapter can be used on almost any pump, with any valve found on the river.
-  • **1 - D7 valve adapter.** Can be used with most pumps with the vinyl tube valve adapter to inflate your boat.
-  • **1 - D7 valve wrench.** Used to tighten or loosen the D7 inflation valve and pressure release valve.
-  • **1 - Repair needle and thread.** Used to stitch tears in the PVC outer shell.
-  • **1 - 5/32" hex key.** Used to tighten or loosen the bolts on the handles or zipper bridge.
-  • **2 - Replacement split rings.** Used to keep the outer zipper cars locked together.
-  • **3 - Type A Tear-Aid patches.** Used to permanently patch small punctures in the AIRE-cell.
-  • **1 - Tear-Aid roll.** Used to temporarily patch tears in the PVC or AIREcell.
-  • **1 - #8 zipper car.** Used to unzip the internal bulkhead zipper.
-  • **4 - Heat shrink tubing.** Used to bind the bulkhead zipper tails together.

BASIC TROUBLE SHOOTING

Valve adapter does not fit my inflation pump.

- There are a number of different raft pumps available. Some are designed with tips that fit directly into the D7 valve and others just have a tapered tip. Connect the vinyl tube valve adapter to the pump hose, connect the D7 valve adapter to the vinyl tube valve adapter, and screw the D7 valve adapter to the valve.

Valve does not retain air when pump is removed.

- Make sure that the valve stem is in the up/closed position.
- Clear any debris that might be preventing the valve from sealing. This can be accomplished by pumping quick bursts of air into the valve with the valve in both closed and open positions.

Tube or floor becomes soft after inflation process.

- Make sure that the valve stem is in the up/closed position.
- Top off air pressure in the cold water to counter thermal contraction.
- Determine which air chamber is soft and make sure the valve is functioning correctly, with no signs of leaking.
- Find the hole in the AIREcell and patch with the Tear-Aid patch.

Tube is puckered or shows a void when inflated.

- The AIREcell might be misaligned. First, deflate the tube(s). Then, while reinflating, shake the tube to free the AIREcell as it inflates.
- If this does not fix the problem, deflate the boat, open the zipper and adjust the AIREcell.

Zipper is difficult to operate.

- Use any combination of soap and water to clean and clear the zipper.

Vinyl repair tape does not stick to AIREcell.

- Make sure that the area to be taped is dry and clean. Use alcohol if necessary to prep the area.

REPAIR

TESTING A VALVE FOR LEAKS

If you suspect a leak in one of the valves, there are a few simple things you can do to check.

Tools you will need:

- Bottle of dish soap mixed with warm water
- Valve wrench from the AIRE repair kit
- Cotton swabs
- Rubbing alcohol
- Pump

1. Inflate the chamber you believe is leaking.
2. Drizzle the soapy water around and inside the valve. If there is a leak, it will start to bubble.
3. If air is coming out of the perimeter, the leak is coming from the seal between the valve and the PVC.
4. If this is the case, use the valve wrench to torque the valve down tight. Pour soapy water on it again to check.
5. If air is coming out of the center of the valve, take a Q-tip soaked in alcohol and thoroughly clean the inner components.
6. If the D7 valve is damaged it can be easily replaced.
 - Unscrew the damaged valve male nut from the female housing with the valve wrench. Make sure to secure the female housing through the PVC with your hand so it doesn't get lost in the AIREcell.
 - Screw in the new valve male nut to the female housing. Torque the valve down tight with the valve wrench.

REPAIR

REPLACING A PRESSURE RELIEF VALVE

Instructions also available on YouTube

<https://www.youtube.com/watch?v=pobzEc0wqYY>



scan code with
smart phone

Tools you will need:

- Valve wrench
 - Slip joint pliers
 - New pressure relief valve
 - Pump
1. Unzip the floor pocket and remove the bladder from the floor of the raft or kayak, and inflate the bladder to pressure.
 2. Remove the pressure relief valve using the valve wrench. Use slip joint pliers for extra torque if necessary.
 3. To install the new valve, make sure the valve base in the floor is lined up and centered in the hole. Using your hands, insert the new valve and thread it about two-thirds of the way down, grasping the base through the floor material.
 4. Inflate the bladder to pressure and torque the valve the rest of the way using the valve wrench, snug but not too tight.
 5. Test the valve for leaks by pouring soapy water in the center and around the perimeter of the valve.

REPAIR

BASEBALL STITCH

Instructions also available on YouTube

<https://www.youtube.com/watch?v=gFrmBcrC8wA>



scan code with
smart phone

The baseball stitch is used to repair a tear in the outer PVC if the boat is damaged on the river. Using a baseball stitch makes a permanent, welded repair easier for a repair shop.

Tools you will need:

- Repair needle
- Repair thread
- Duct tape or Tear-Aid roll

1. Locate the tear in the PVC and deflate the chamber.
2. Unzip the chamber for easy access to the tear and to keep the repair needle away from the AIREcell.
3. Each stitch starts at the BACK of the PVC and comes through to the FRONT of the PVC. Follow the pattern below to stitch up the tear.

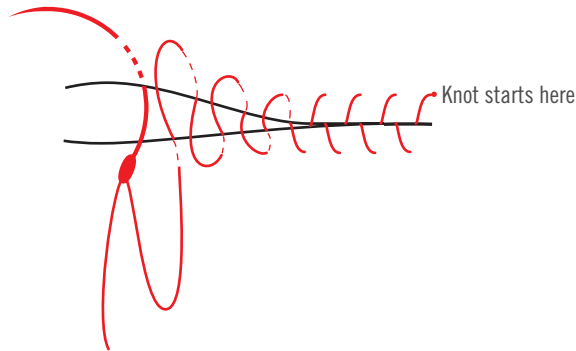

4. After the tear is stitched together, cover the seam with duct tape or Tear-Aid from the roll to protect the stitching and prevent any dirt or debris from getting inside the chamber.

REPAIR

TEAR-AID REPAIR

Instructions also available on YouTube

<https://www.youtube.com/watch?v=gFrmBcrC8wA>



scan code with
smart phone

Your repair kit comes with a long roll of Tear-Aid to fix punctures or tears in the AIREcell if the boat is damaged while on the river. Small punctures can be permanently fixed with Tear-Aid. Large tears can be fixed with Tear-Aid on the river, but we recommended replacing the AIREcell when you get home.

Tools you will need:

- Alcohol prep pads
- Tear-Aid patch or Tear-Aid roll
- Knife or scissors

1. Unzip the PVC shell to access the tear or puncture in the AIREcell.
2. If the tear or puncture is hard to find. Inflate the chamber and drizzle with some soapy water. Bubbles will appear where the air is leaking through.
3. Clean the AIREcell around the puncture or tear with the alcohol prep pad so the Tear-Aid sticks to the AIREcell.
4. Allow the alcohol to dry completely.
5. Cut a strip of Tear-Aid a few inches longer than the tear. Round off the corners to prevent the patch corners from lifting. For a small puncture use a Tear-Aid patch.
6. Peel the backing off the Tear-Aid and carefully apply it over the tear or puncture, working out any wrinkles or air bubbles.

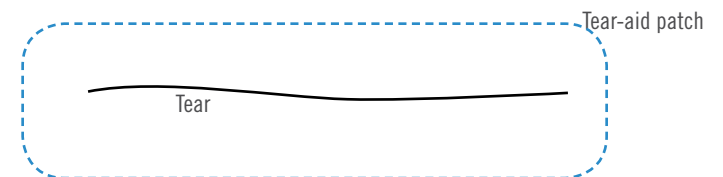

REPAIR

ADVANCED REPAIR RESOURCES:

Installing an AIREcell into a raft collar
<https://www.youtube.com/watch?v=QmYJl7zVfnk>



scan code with
smart phone

Installing a floor AIREcell into a raft floor pocket
<https://www.youtube.com/watch?v=XdStd0u2mRl>



scan code with
smart phone

Double zipper car installation
<https://www.youtube.com/watch?v=3lByf57W6gY>



scan code with
smart phone

Handle replacement
<https://www.youtube.com/watch?v=LI4Ca9FZeXM>



scan code with
smart phone

REPAIR

SEALED FLOOR POCKET

Instructions also available on YouTube
https://www.youtube.com/watch?v=miY_LDJgY0c



scan code with
smart phone

If you purchased the sealed floor option, the raft floor AIREcell can be accessed through a short airtight zipper found under the zipper cover. This zipper should be inspected annually by pulling the cover rod on the deflated floor.

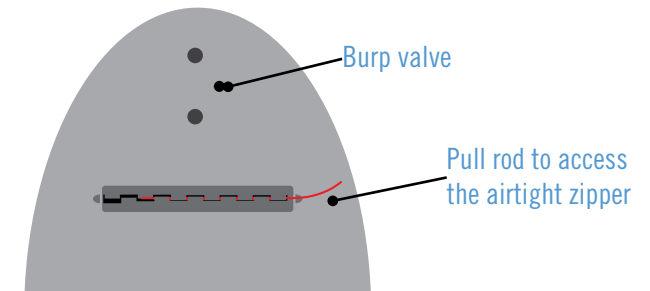

1. Open the zipper and check to see if it is dry on the inside. Lube the zipper with the supplied zipper lube and re-close it, making sure that the slider is in the airtight end boot.
2. If it is wet on the inside you may have a leak in the pocket. To determine this, close the zipper and inflate the pocket, not the AIREcell, through the "burp valve." The pocket can then be soaped up to find the leak.
3. To remove the cell, the valves must be loosened with air pressure in the cell, then deflated and removed.
4. To reinstall, fold the cell into the top narrower than the zipper opening. Slide the cell in, pushing it past the end with the valves, then pull it forward and reinstall the valves. Softly inflate the floor and pat the top surface to get it to fill out the pocket completely.
5. Close the zipper and cover. Inflate the floor, and then fully tighten the valves. Burp out any captured air between the cell and the pocket.

REPAIR

RETURNS

If you have damage to your boat that is beyond your abilities to repair, please contact AIRE at 844-556-5730 for a Return Authorization (RA) number. Please put a brief note with your contact information and a detailed description of the repairs necessary inside the box and ship the package to the address below with the RA number clearly written on the outside of the box. Please ship the boat with a service that provides a tracking number.

AIRE

Attn: AIRE repair (Put RA number here)
2021 E. Wilson Lane
Meridian, ID 83642

AUTHORIZED SERVICE CENTER

Repairs and warranty work can be done at one of our authorized service centers:

Goodwater Boat Works

8605 NE 51st Ave
Vancouver, WA 98665
503-453-0713
vic@goodwaterboatworks.com

Inflatable Restoration & Repair

Erik Lang
3244 East US Highway 50
Salida, CO 81201
719-539-9751
mtnkaos9@amigo.net

Whitewater Inflatable Repair

Zach Sack
3133 W. Hampden Ave.
Sheridan, CO 80110
720-309-6225
info@raftrepair.com

Nantahala Outdoor Center

ATTN: Nantahala Raft Repair
13077 Highway 19W
Bryson City, NC 28713
828-488-4349
nantahalarrs@gmail.com

Ocoee Raft Repair

1548 Highway 68,
Ducktown, TN 37326
OcoeeRaftRepair@yahoo.com
Stephen Martin 770-561-1332
Colton Myers 706-455-1599

Green River Products

Shane Green
663 highway 64
Ocoee TN, 37361
(423) 584-1683
raftrepair@gmail.com

Alaska Raft & Kayak

401 West Tudor Road
Anchorage, AK 99503
800-606-5950

Darren Grab

82-51551 Range Rd 212A
Sherwood Park, AB T8G1B2
Phone:(587) 988-1005
raftrepaircanada@gmail.com

Crossroads S.A.

Jeff Brummel
Arizaga Luque N34-432 y Guerrero
Quito, Ecuador
Telefax: (593-2) 510-8558 /
254-5514
email: jbrummel@
crossroadshostal.com

WARRANTY

10 YEAR NO FAULT WARRANTY

What this Warranty Covers: The ten (10) year no fault warranty covers retail purchases on all AIRE branded rafts, catarafts, and kayaks against defects in materials, workmanship, and user damage. This warranty covers the tubes, fabric, D-ring patches, AIREcells, valves, and zippers to be functional and water worthy with the following stipulations:

- This warranty can be void if the boat is structurally altered, used commercially or is subject to stress beyond the physical limits of the fabric and/or accessories.
- This warranty does not cover cosmetic wear, abrasion, excessive UV damage, abnormal abuse, neglect, and/or inappropriate storage.

The Period of Coverage: The boat is covered from the original purchase date for a period of ten years. When original proof of purchase is not available or if a warranty registration was never submitted, the date of manufacturing will be used. This warranty is transferable.

5 YEAR COMMERCIAL WARRANTY

What this Warranty Covers: The five (5) year no fault warranty covers commercial, non-profit, and government use, as well as pro-form purchases on all AIRE branded boats against defects in materials, workmanship, and user damage. This warranty covers the tubes, fabric, D-ring patches, AIREcells, valves, and zippers to be functional and water worthy with the following stipulations:

- This warranty can be void if the boat is structurally altered or is subject to stress beyond the physical limits of the fabric and/or accessories.
- This warranty does not cover cosmetic wear, abrasion, excessive UV damage, abnormal abuse, neglect, and/or inappropriate storage.

The Period of Coverage: Your boat is covered from the original purchase date for a period of five years. When original proof of purchase is not available, we will use the date of manufacturing for a period of five years. This warranty is transferable.



Thank you for choosing AIRE!