

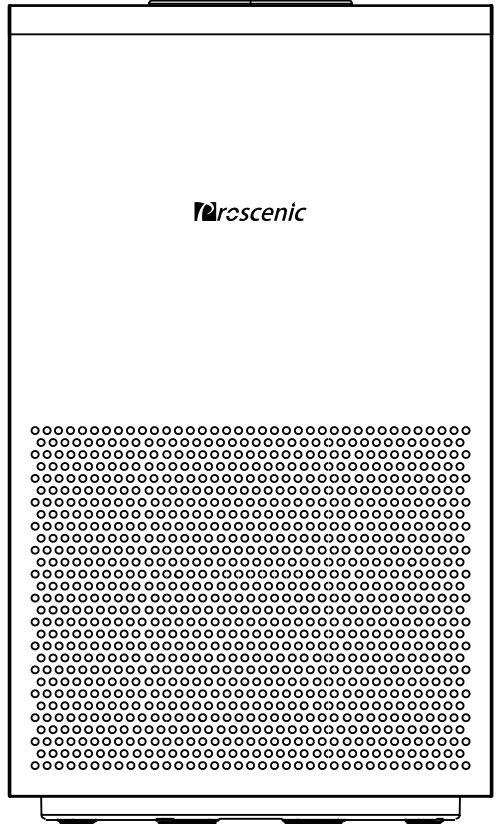

A8

User Manual











Proscenic Technology Co., Ltd.
Service support
Web: www.proscenic.com
E-mail: service@proscenic.tw

SAFETY PRECAUTIONS

In order to avoid possible damage to you, others or property, make sure to pay attention to the following safety precautions.

If the machine power chord is broken or unit is out of order; you must contact customer service to ensure safety.









WARNING

 <p>Do not touch power plug with wet hands. Wet hands can cause electric shock. Never touch with wet hands.</p>	 <p>Turn off the power before cleaning machine. Unplug before cleaning to avoid electric shock or unit turning on accidentally.</p>
 <p>Do not take apart or modify unit without authorization. Taking apart or modifying without authorization may cause personal injury or unit malfunction.</p>	 <p>Do not put bars or metal products nearby air outlet or openings. If metal bars touch inside of machine it can cause electric shock.</p>
 <p>Do not damage power line and socket. Do not bind wires when you use the unit. It may cause electric shock, short circuit, or fire if you use broken wires. Forbidden to cut, scratch, refit, distort, twist or pull power lines. Do not put any heavy products on top of wires or sockets</p>	 <p>Regularly clean power plug. Do not allow dust to accumulate on power plug. This can damage insulation and cause a fire accident. Pull out the power plug and clean with dry cloth (do not use wet cloth). If machine is not planned to be used for any extended period of time, unplug it for safety reasons.</p>
 <p>Prohibited use beyond power. Use only at the specified voltage. If used under other voltages, it may damage or destroy the circuit board.</p>	 <p>Please insert the plug completely into the power socket before starting the air purifier. If not, may cause electric shock and overheating, even fire accident. Do not use damaged plug or loose socket.</p>

READ AND SAVE THESE INSTRUCTIONS.

- WARNING –TO REDUCE THE RISK OF FIRE OR ELECTRIC SHOCK, DO NOT USE THIS AIR PURIFIER WITH ANY SOLID–STATE SPEED CONTROL DEVICE.
- WARNING – UNPLUG OR DISCONNECT THIS AIR PURIFIER FROM THE POWER SUPPLY BEFORE SERVICING.
- WARNING –THIS APPLICANCE HAS A POLARIZED PLUG (ONE BLADE IS WIDER THAN OTHER). TO REDUCE THE RISK OF ELECTRIC SHOCK, THIS PLUG IS INTENDED TO FIT IN A POLARIZED OUTLET ONLY ONE WAY. IF THE PLUG DOES NOT FIT FULLY IN THE OUTLET REVERSE THE PLUG. IF IT STILL DOES NOT FIT, CONTACT A QUALIFIED ELECTRICIAN. DO NOT ATTEMPT TO DEFECT THIS SAFETY FEATURE.

WARNING

 <p>Keep machine dry. Or else it may cause electric shock or fire accident.</p>	 <p>Keep machine away from volatile substances or flammable items. This could cause fire.</p>
 <p>Do not use air purifier in a greasy area. This machine should not be used as ventilating or air evacuating equipment</p>	 <p>Do not use air purifier in high temperature or humid conditions. These situations may cause current damage, electric shock or fire accident.</p>
 <p>Do not use the air purifier in the room with fumigation type pesticides. Chemical residue could be accumulated inside the machine and then released, causing harm. The room should keep ventilated thoroughly after you use insecticide and then start to use air purifier.</p>	 <p>If you use the air purifier in a room with an electric heater, ensure proper ventilation. Otherwise, there could be a buildup of carbon monoxide, which can cause serious harm or death. The air purifier will NOT remove carbon monoxide from the air.</p>
 <p>Do not use solvents like benzene, diluent, etc. to clean the air purifier. This can cause the air purifier to break, to become damaged, or short circuit which can lead to electric shock or fire accidents.</p>	 <p>Be careful when removing the plug from the power socket. Do not pull wires which may cause short circuit or damage to wires, to avoid possible fire accident or electric shock.</p>

PRODUCT INFORMATION

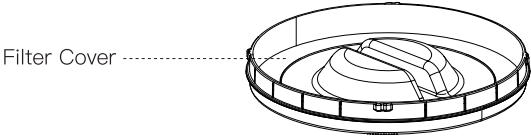
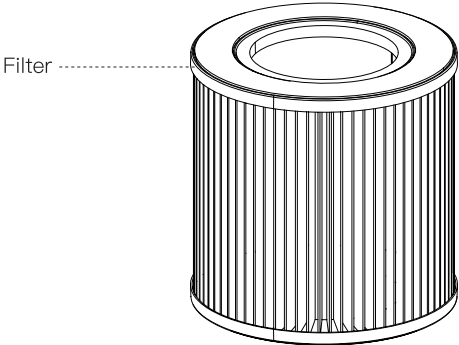
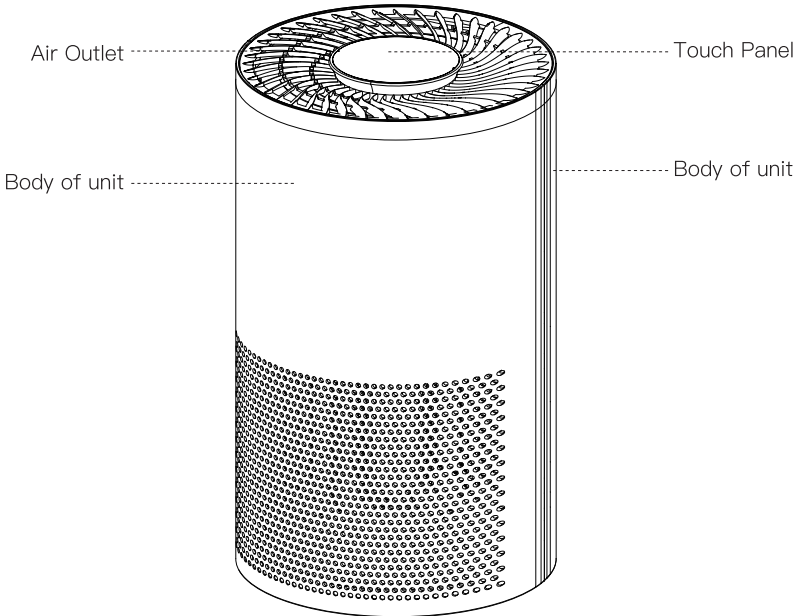

Functional Description of Control Panel

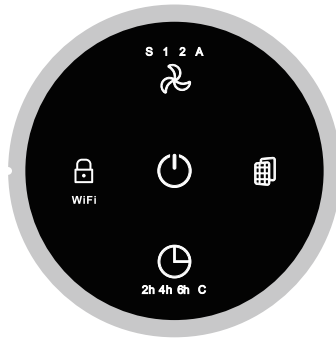

Child Lock



Hold the child lock button for 5 seconds to lock/unlock the machine.
The button cannot be used in the child lock mode.

Power ON/OFF



Press to turn unit on/off.

WiFi Control



Press and hold the power button for 5 seconds to turn on the WiFi indicator light.
WiFi indicator light will flash slowly as it searches for a signal.

Timer Mode



Press to set timer at 2, 4, 6 hours.
The C light will only come on when the time is scheduled longer than 6 hours. And this operation can only be set on the APP.

Filter Indicator



Filter indicator light calculates based on 2,000 hours of use.

Fan Speed



S: Sleep mode
1: Speed 1 (low)
2: Speed 2 (high)
A: Auto and SMART mode

BEFORE USE

Learning About Air Quality Indicator Light

Air quality indicator reflects the current air quality condition. Light will show at the bottom of the unit, as referenced below.

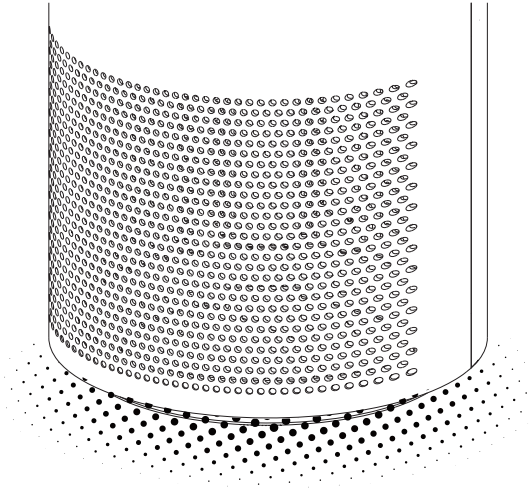

Air Quality Indicator Light Index

Green	Excellent
Yellow	Good
Red	Poor

Install Filter Set

All filters must be used together. Do not disassemble filter set.

1. Turn unit over and remove filter cover at the bottom of the air inlet. Press firmly and turn left in the direction indicated by the arrow to remove cover.

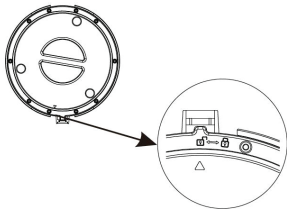

3. Remove the filter, which is enclosed in the plastic bag.

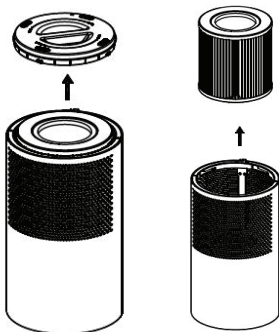

Attention
Please remove all packaging on the filters before use.
Do not use the air purifier without filters.

2. Remove the plastic bag.

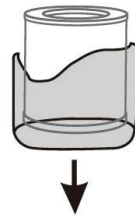

4. Re-insert the filter. Re-attach the filter cover and turn right to lock it in place. Align arrows to lock in place.

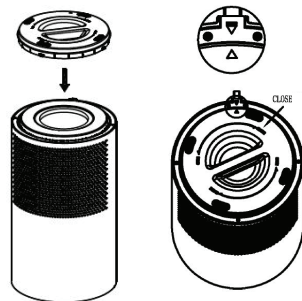

TRUE HEAP PURIFICATION: 3 STEPS

First step: Pre-filter

Second step: Activated carbon filter

Third step: H13 HEPA filter

1. Pre-Filter

Removes larger particles including hair, fibers, dander, and others.

2. Activated Carbon Filter

Absorbs odors, harmful VOCs, and other toxic substances such as formaldehyde.

3. HEPA H13 Filter

HEPA H13 is a medical grade filter. This removes 99.97% of particles down to 0.3 microns as well as PM2.5 particles such as, smoke, pollen, dust mites and others.

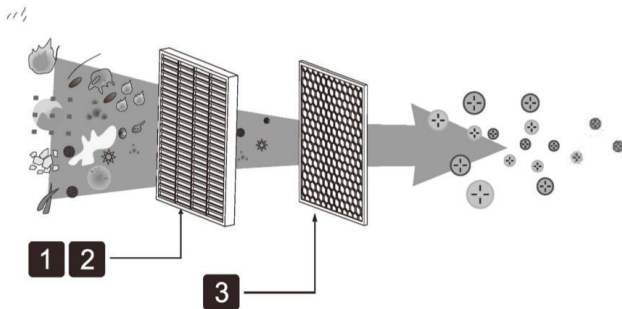

HOW TO USE



Child Lock

Hold the child lock button for 5 seconds to lock/unlock the machine.

The button cannot be used in the child lock mode.



Adjustment of Fan Speed

Press to choose air speed: S, 1, 2, A
S = SLEEP mode. In SLEEP mode, unit will turn to low, control panel lights will dim, and unit will not beep.

A = AUTO mode. In AUTO mode, unit will select fan speed based on the air quality. Higher speed indicates worse pollution levels.



Filter Life Indicator

When you begin use, unit will start to calculate filter life. Each time you turn on the unit, you will hear 3 beeps and filter LED light will flash. The useful life of the filter is 2,000 hours of use.



Turn on the Air Purifier

Press ON/OFF button to use unit.



Timer mode

Press button and choose hour options: 2, 4, 6 or no timer. The C light will only come on when the time is scheduled longer than 6 hours. And this operation can only be set on the APP.

MAINTENANCE AND CLEANING

Please make sure to pull out power plug before cleaning the unit. Do not immerse machine in water or any other liquid. Do not use abrasive, corrosive or flammable products to clean any parts of the unit. The unit uses composite filters, so filters cannot be washed.

Clean the Air Purifier

Clean the air purifier regularly to prevent the dust accumulation.

1. Use soft and dry cloths to remove the dust from the air purifier.
2. Use soft and dry cloths to clean the outlet and inlet of the air purifier

Change Filter

The unit will remind user when filter needs to be replaced.



To replace filter, follow same steps as User Manual.

Then, press filter indicator button for 5 seconds. After 3 beeps, LED light turns off. This resets the filter indicator and the unit will begin to recalculate filter life from 2,000 hours once again.

Clean the Air Quality Sensor

Clean air quality sensor every two- months to ensure best performance.

Clean often if machine works in dusty environment.

1. Use soft brush to clean intake and outlet of air quality sensor.
2. Disassemble the cover of air quality sensor.
3. Use a dry swab to clean the air quality sensor, air intake and air outlet.
4. Reinstall the cover of air quality sensor.

Technical Data

Voltage	120V AC 60 Hz
Rated power	50 W
Noise level	< 55 dB
Dimension	412mm H x 238mm W x 258mm D

COMMON QUESTIONS

The following table lists possible questions and steps to address them. Please contact Customer service if you cannot find an answer to your question below.

Issue	Possible Reason	Possible Solution
Unit does not work	Filter cover not installed correctly	Remove bottom cover and re-install
	Bottom cover not locked in place	Check that bottom cover is turned into locked position
	Power supply for plug	Pull out plug and plug it back into unit
	Incorrect power plug or wire	Contact customer service
Fan does not work	Machine doesn't turn on	Plug it in and turn on
	Motor is not working	Contact customer service
	Unit on uneven ground	Move to flat surface
	Loose or foreign particles inside	Contact customer service
	Filter packaging not removed	Remove plastic from filters
	Motor is loose	Contact customer service
Performance Issues	Filters need to be replaced	Replace with Genuine Proscenic A8 replacement filters for best results
	Air intake/outlet blocked	Contact customer service
	Filter packaging not removed	Remove plastic from filters
	Not enough space surrounding unit	Ensure 10 in. distance between sides of air intake and that distance to air outlet is not less than 8 in.
	Lack of filter or filter is not properly installed	Make sure all filters are placed in the order in accordance with instructions
	Coverage area questions	Check whether room area surpasses coverage area estimates

Service

If you have any additional questions, please contact customer service.

All names and trademarks are property of Proscenic. Our company reserves the right to change the product at any time, without prior notice, and the company has no obligation to adjust products supplied earlier.

Order Parts or Accessories

If you want to change parts or purchase additional parts, please contact customer service.

Long-time Idling

Do not leave unit plugged in for an extended period of time when not in use. Place machine in a dry and well-ventilated place when not in use for extended period of time.