



VAN ROOF RACKS

Ergonomic Ladder Racks make loading and unloading easier.



TOUGH

Military grade aluminum extrusion, high density plastic and stainless steel components ensure no corrosion over the lifetime of the rack.



QUIET

Aerodynamic design with minimal wind noise.



SAFE

No metal contact to ladder, leading to longer life of ladders with less chance of fiberglass splinters.

VAN ROOF RACKS

CARGO RACK

CARGO P. 198
 CARGO+ P. 196

CLAMP RACK

COMBINATION RACK P. 200
 DOUBLE CLAMP RACK P. 202

INTERIOR RACK P. 195

LADDER RACK ACCESSORIES P. 201

MAX RACK 2.0

MAX RACK 2.0 LOW ROOF P. 204
 MAX RACK 2.0 HIGH ROOF P. 206

ACCESS STOW P. 210

NOMENCLATURE P. 194

SUB-UNIT GUIDE P. 212

Ranger Design ladder racks make loading and unloading ladders an easy operation. Ranger Design offers drop-down ladder racks for high roof vans, extra tough racks capable of carrying 32' ladders on compact vans, interior ladder carriers and many other options for different applications.

Please take note that all our ladder racks are powder-coated white except for the Cargo+.

N.B. Models may vary to those shown. Please visit our website for all images.

BEFORE YOU START, ASK YOURSELF

- › What ladders will I be carrying?
- › How often will I be accessing the ladder?



NOMENCLATURE

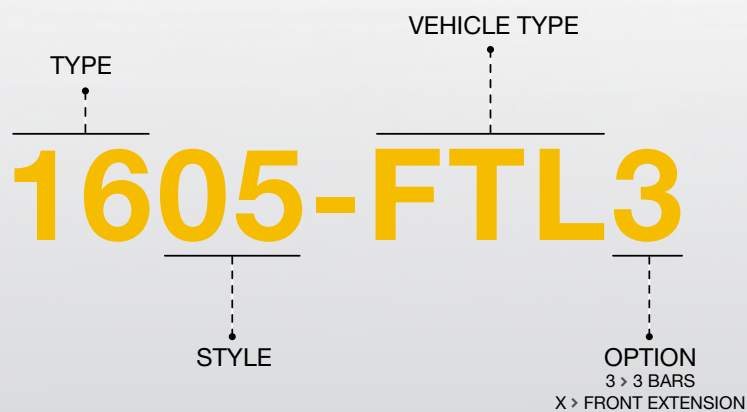

STYLES

1050	Interior Rack
1506	Cargo+ Rack
1605	Cargo Rack
1625	Combination Clamp Rack
1630	Double Clamp Rack
1840	Single Max Rack 2.0 Low Roof
1850	Double Max Rack 2.0 Low Roof
1870	Single Max Rack 2.0 High Roof
1880	Double Max Rack 2.0 High Roof
1920	Single Access Stow
1930	Double Access Stow

The weight capacity varies according to each vehicle's capabilities. Please consult your vehicle's manual for weight capacity.

1050 SERIES INTERIOR RACK DESIGNED FOR FULL SIZE VANS

SAFE

- > Convenient and secure storage for your smaller ladders

TOUGH

- > Military grade aluminum and stainless steel components

SIMPLE

- > Fits all vans



Access Pro, Inside Ladder Carrier

Aluminum

PART					
1050-FS	All	All	10" W x 96" L x 7.5" H	9 lbs	1 hr

VAN ROOF RACKS

VAN ROOF RACKS – CARGO +

1506 SERIES

CARGO +

DESIGNED FOR ALL SIZE VANS



CARGO + FEATURES AND BENEFITS

The Rear Roller is constructed from tough and hard wearing stainless steel and attaches easily to the roof rack using our “Anti-Rattle” composite connectors.

The **Cargo+** features T-Track technology which enables quick and easy drill free installs.



The **Cargo+** is the perfect tool for transporting ladders, building materials, pipes and scaffolding.

The **Cargo+** cross bars have been specifically designed to reduce wind noise and drag. The Rear Roller as part of the package of the **Cargo+** is not just a great looking addition to your vehicle, it is also an extra helping hand at the end of a busy day.

MAKE THE BEST USE OF ALL THE SPACE YOU HAVE AVAILABLE ON YOUR VEHICLES!

Aluminum								
PART	VEHICLE							
1506-FTL	FORD TRANSIT	148"	L / M	68" W × 150" L × 10" H	220 lbs	65"	109 lbs	2 hrs
1506-FTR	FORD TRANSIT	130"	L / M	68" W × 134" L × 10" H	220 lbs	65"	93 lbs	2 hrs
1506-FTX	FORD TRANSIT	148" Ext	High	65" W × 157" L × 7" H	220 lbs	65"	111 lbs	2 hrs
1506-TC	FORD TRANSIT CONNECT	120"	Standard	54" W × 103" L × 10" H	100 lbs	51"	65 lbs	2 hrs
1506-GS	GM SAVANA / EXPRESS	Reg	Standard	68" W × 149" L × 7" H	220 lbs	65"	105 lbs	2 hrs
1506-MM	MERCEDES-BENZ METRIS	126"	Standard	60" W × 126" L × 10" H	220 lbs	57"	89 lbs	2 hrs
1506-M	MERCEDES-BENZ METRIS	135"	Standard	60" W × 133" L × 7" H	220 lbs	57"	92 lbs	2 hrs
1506-DS	MERCEDES-BENZ SPRINTER	144"	Standard	68" W × 134" L × 9" H	220 lbs	65"	100 lbs	2 hrs
1506-DH	MERCEDES-BENZ SPRINTER	170", 170" Ext	High	68" W × 157" L × 7" H	220 lbs	65"	113 lbs	2 hrs
1506-NL	NISSAN NV	146"	Low	68" W × 133" L × 7" H	220 lbs	65"	97 lbs	2 hrs
1506-NH	NISSAN NV	146"	High	68" W × 103" L × 7" H	220 lbs	65"	86 lbs	2 hrs
1506-NS	NISSAN NV200	115"	Standard	54" W × 103" L × 7" H	100 lbs	51"	64 lbs	2 hrs
1506-PHS	RAM PROMASTER	118"	Standard	68" W × 126" L × 10" H	220 lbs	65"	94 lbs	2 hrs
1506-PHM	RAM PROMASTER	136"	L / H	68" W × 133" L × 10" H	220 lbs	65"	97 lbs	2 hrs
1506-PHL	RAM PROMASTER	159"	M / H	68" W × 149" L × 7" H	220 lbs	65"	104 lbs	2 hrs
1506-PHX	RAM PROMASTER	159" Ext	High	68" W × 157" L × 7" H	220 lbs	65"	107 lbs	2 hrs
1506-PC	RAM PROMASTER CITY	122"	Standard	54" W × 103" L × 6" H	100 lbs	51"	68 lbs	2 hrs

SEE PAGE 212 FOR SUB-UNIT

VAN ROOF RACKS – CARGO RACK

1605 SERIES

CARGO RACK

DESIGNED FOR ALL SIZE VANS









1605-FTL SHOWN HERE.

Individual models may vary to accommodate each vehicle and may be different.

Cargo rack – 2 bar

Aluminum

PART	VEHICLE						
1605-GS	CHEVROLET EXPRESS	135", 155"	Standard	73.5" W × 65" L × 13" H	480 lbs	27 lbs	0.8 hr
1605-FTL	FORD TRANSIT	148", 148" Ext	L / M / H	73.5" W × 97" L × 12" H	480 lbs	34 lbs	1.1 hrs
1605-FTR	FORD TRANSIT	130"	L / M	73.5" W × 84" L × 12" H	480 lbs	32 lbs	1.1 hrs
1605-TC	FORD TRANSIT CONNECT	105"	Standard	61.5" W × 70.5" L × 12.5" H	480 lbs	28 lbs	1.1 hrs
1605-GS	GMC SAVANA	135", 155"	Standard	73.5" W × 65" L × 13" H	480 lbs	27 lbs	0.8 hr
1605-MM	MERCEDES-BENZ METRIS	126", 135"	Standard	67.5" W × 86.5" L × 12.5" H	480 lbs	31 lbs	1.1 hrs
1605-DH	MERCEDES-BENZ SPRINTER	144", 170", 170" Ext	Standard, High	73.5" W × 110" L × 12" H	480 lbs	36 lbs	1.1 hrs
1605-PHS	RAM PROMASTER	118"	Standard	73.5" W × 88.5" L × 12" H	480 lbs	33 lbs	1.1 hrs
1605-PHM	RAM PROMASTER	136"	Standard, High	73.5" W × 106" L × 12" H	480 lbs	35 lbs	1.1 hrs
1605-PHL	RAM PROMASTER	159"	High	73.5" W × 133.5" L × 12" H	480 lbs	38 lbs	1.1 hrs
1605-PHX	RAM PROMASTER	159" Ext	High	73.5" W × 147.5" L × 12" H	480 lbs	39 lbs	1.1 hrs
1605-PC	RAM PROMASTER CITY	122"	Standard	61.5" W × 79" L × 12.5" H	480 lbs	29 lbs	1.1 hrs

VAN ROOF RACKS – CARGO RACK

TOUGH

- › Military grade aluminum and stainless steel components.
- › No corrosion over the lifetime of the rack.

QUIET

- › Aerodynamic crossbars reduce wind noise and drag.

SIMPLE







- › Economical solution for additional cargo and ladder transportation



1605-MM3 SHOWN HERE

Individual models may vary to accommodate each vehicle and may be different.

Cargo rack – 3 bar

Aluminum							
PART	VEHICLE						
1605-GS3	CHEVROLET EXPRESS	135", 155"	Standard	73.5" W × 65" L × 13" H	720 lbs	40 lbs	1.1 hrs
1605-FTL3	FORD TRANSIT	148", 148" Ext	L / M / H	73.5" W × 97" L × 12" H	720 lbs	45 lbs	1.4 hrs
1605-FTR3	FORD TRANSIT	130"	L / M	73.5" W × 84" L × 12" H	720 lbs	43 lbs	1.4 hrs
1605-TC3	FORD TRANSIT CONNECT	135", 155"	Standard	61.5" W × 70.5" L × 12.5" H	720 lbs	38 lbs	1.4 hrs
1605-GS3	GMC SAVANA	135", 155"	Standard	73.5" W × 65" L × 13" H	720 lbs	40 lbs	1.1 hrs
1605-MM3	MERCEDES-BENZ METRIS	126", 135"	Standard	67.5" W × 86.5" L × 12.5" H	720 lbs	41 lbs	1.4 hrs
1605-DH3	MERCEDES-BENZ SPRINTER	144", 170", 170" Ext	Standard, High	73.5" W × 110" L × 12" H	720 lbs	47 lbs	1.4 hrs
1605-PHS3	RAM PROMASTER	118"	Standard	73.5" W × 88.5" L × 12" H	720 lbs	44 lbs	1.4 hrs
1605-PHM3	RAM PROMASTER	136"	Standard, High	73.5" W × 106" L × 12" H	720 lbs	46 lbs	1.4 hrs
1605-PHL3	RAM PROMASTER	159"	High	73.5" W × 133.5" L × 12" H	720 lbs	49 lbs	1.4 hrs
1605-PHX3	RAM PROMASTER	159" Ext	High	73.5" W × 147.5" L × 12" H	720 lbs	50 lbs	1.4 hrs
1605-PC3	RAM PROMASTER CITY	122"	Standard	61.5" W × 79" L × 12.5" H	720 lbs	39 lbs	1.4 hrs

The number 3 refers to the number of bars.

SEE PAGE 212 FOR SUB-UNIT

VAN ROOF RACKS – COMBINATION RACK

1625 SERIES

COMBINATION RACK

DESIGNED FOR ALL SIZE VANS









1625-FTR SHOWN HERE

Individual models may vary to accommodate each vehicle and may be different.

THIS SERIES OF RACK WILL BE AVAILABLE AS OF JULY 2021

Combination Rack – 2 bar

Aluminum

PART	VEHICLE							
1625-GS	CHEVROLET EXPRESS	135", 155"	Standard	78.5" W × 101" L × 17" H	480 lbs	56 lbs	32 ft	1.2 hrs
1625-FTL	FORD TRANSIT	148", 148" Ext	L / M / H	78.5" W × 102" L × 15.5" H	480 lbs	63 lbs	32 ft	1.5 hrs
1625-FTR	FORD TRANSIT	130"	L / M	78.5" W × 101" L × 15.5" H	480 lbs	61 lbs	32 ft	1.5 hrs
1625-TC	FORD TRANSIT CONNECT	105", 120.5"	Standard	66.5" W × 82.5" L × 16.5" H	480 lbs	57 lbs	24 ft	1.5 hrs
1625-GS	GMC SAVANA	135", 155"	Standard	78.5" W × 101" L × 17" H	480 lbs	56 lbs	32 ft	1.2 hrs
1625-MM	MERCEDES-BENZ METRIS	126", 135"	Standard	72.5" W × 100.5" L × 16.5" H	480 lbs	60 lbs	28 ft	1.5 hrs
1625-DH	MERCEDES-BENZ SPRINTER	144", 170", 170" Ext	Standard, High	78.5" W × 100" L × 16" H	480 lbs	65 lbs	32 ft	1.5 hrs
1625-PHS	RAM PROMASTER	118"	Standard	78.5" W × 100.5" L × 16" H	480 lbs	62 lbs	28 ft	1.5 hrs
1625-PHM	RAM PROMASTER	136"	Standard, High	78.5" W × 106" L × 16" H	480 lbs	64 lbs	32 ft	1.5 hrs
1625-PHL	RAM PROMASTER	159"	High	78.5" W × 133.5" L × 16" H	480 lbs	67 lbs	32 ft	1.5 hrs
1625-PHX	RAM PROMASTER	159" Ext	High	78.5" W × 147.5" L × 16" H	480 lbs	69 lbs	32 ft	1.5 hrs
1625-PC	RAM PROMASTER CITY	122"	Standard	66.5" W × 85" L × 16.5" H	480 lbs	58 lbs	24 ft	1.5 hrs

LADDER RACK ACCESSORIES

DESIGNED FOR ALL SIZE VANS



STEP LADDER KIT

Comes with nylon strap and a step lock

- This accessory will fit on any single side ladder rack, except the Cargo +
- You can install one step ladder from 3' to 8'.
- Will fit just about any rack that doesn't have a handle on the right hand side.
- If added to the Max Rack, a third crossbar is needed for this accessory.

16-U1127

Step Ladder Kit

Aluminum							
PART	VEHICLE						
16-U1127	UNIVERSAL	All	All	24" W x 96" L x 11" H	–	18 lbs	0.5 hr



16-U1130

Elevated strobe mount

Aluminum	
	8" W
	1 lb
	0.1 hr
	No



16-U6078

Cradle & strap kit for 6" dia. transport tube (one cradle and one strap)

Aluminum	
	6" D
	1 lb
	0.1 hr
	Yes

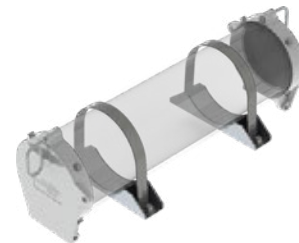

16-U6079

Transport tube door kit complete (6" dia./schedule 40 PVC tube not incl.)

Aluminum	
	6" D
	8 lbs
	0.8 hr
	Yes

VAN ROOF RACKS – CLAMP RACK

1630 SERIES

DOUBLE CLAMP RACK

DESIGNED FOR ALL SIZE VANS









1630-FTR SHOWN HERE

Individual models may vary to accommodate each vehicle and may be different.

THIS SERIES OF RACK WILL BE AVAILABLE AS OF JULY 2021

Double Clamp Rack

Aluminum

PART	VEHICLE							
1630-GS	CHEVROLET EXPRESS	135", 155"	Standard	84.5" W × 94.5" L × 17" H	480 lbs	51 lbs	32 ft	1.2 hrs
1630-FTL	FORD TRANSIT	148", 148" Ext	L / M / H	84.5" W × 97" L × 15.5" H	480 lbs	58 lbs	32 ft	1.5 hrs
1630-FTR	FORD TRANSIT	130"	L / M	84.5" W × 96" L × 15.5" H	480 lbs	56 lbs	32 ft	1.5 hrs
1630-TC	FORD TRANSIT CONNECT	135", 155"	Standard	73" W × 82.5" L × 16.5" H	480 lbs	52 lbs	24 ft	1.5 hrs
1630-GS	GMC SAVANA	135", 155"	Standard	84.5" W × 94.5" L × 17" H	480 lbs	51 lbs	32 ft	1.2 hrs
1630-MM	MERCEDES-BENZ METRIS	126", 135"	Standard	79" W × 96" L × 16.5" H	480 lbs	55 lbs	28 ft	1.5 hrs
1630-DH	MERCEDES-BENZ SPRINTER	144", 170", 170" Ext	Standard, High	84.5" W × 100" L × 16" H	480 lbs	60 lbs	32 ft	1.5 hrs
1630-PHS	RAM PROMASTER	118"	Standard	84.5" W × 97" L × 16" H	480 lbs	57 lbs	28 ft	1.5 hrs
1630-PHM	RAM PROMASTER	136"	Standard, High	84.5" W × 106" L × 16" H	480 lbs	59 lbs	32 ft	1.5 hrs
1630-PHL	RAM PROMASTER	159"	High	84.5" W × 133.5" L × 16" H	480 lbs	63 lbs	32 ft	1.5 hrs
1630-PHX	RAM PROMASTER	159" Ext	High	84.5" W × 147.5" L × 16" H	480 lbs	64 lbs	32 ft	1.5 hrs
1630-PC	RAM PROMASTER CITY	122"	Standard	73" W × 85" L × 16.5" H	480 lbs	52 lbs	24 ft	1.5 hrs

VAN ROOF RACKS – CLAMP RACK

TOUGH

- › Military grade aluminum and stainless steel components.
- › No corrosion over the lifetime of the rack.

SAFE

- › No metal contact to ladder, leading to longer life of ladders with less chance of fiberglass splinters.

SIMPLE

- › Clamping mechanism makes securing ladders a simple and easy task.



1630-FTR3 SHOWN HERE

Individual models may vary to accommodate each vehicle and may be different.

Double Clamp Rack – 3 bar

Aluminum								
PART	VEHICLE							
1630-GS3	CHEVROLET EXPRESS	135", 155"	Standard	84.5" W × 94.5" L × 17" H	720 lbs	63 lbs	32 ft	1.4 hrs
1630-FTL3	FORD TRANSIT	148", 148" Ext	L / M / H	84.5" W × 97" L × 15.5" H	720 lbs	68 lbs	32 ft	1.7 hrs
1630-FTR3	FORD TRANSIT	130"	L / M	84.5" W × 96" L × 15.5" H	720 lbs	66 lbs	32 ft	1.7 hrs
1630-GS3	GMC SAVANA	135", 155"	Standard	84.5" W × 94.5" L × 17" H	720 lbs	63 lbs	32 ft	1.4 hrs
1630-MM3	MERCEDES-BENZ METRIS	126", 135"	Standard	79" W × 96" L × 16.5" H	720 lbs	64 lbs	28 ft	1.7 hrs
1630-DH3	MERCEDES-BENZ SPRINTER	144", 170", 170" Ext	Standard, High	84.5" W × 100" L × 16" H	720 lbs	70 lbs	32 ft	1.7 hrs
1630-PHS3	RAM PROMASTER	118"	Standard	84.5" W × 97" L × 16" H	720 lbs	67 lbs	28 ft	1.7 hrs
1630-PHM3	RAM PROMASTER	136"	Standard, High	84.5" W × 106" L × 16" H	720 lbs	69 lbs	32 ft	1.7 hrs
1630-PHL3	RAM PROMASTER	159"	High	84.5" W × 133.5" L × 16" H	720 lbs	72 lbs	32 ft	1.7 hrs
1630-PHX3	RAM PROMASTER	159" Ext	High	84.5" W × 147.5" L × 16" H	720 lbs	73 lbs	32 ft	1.7 hrs

The number 3 refers to the number of bars.

Extended Clamp Rack – 3 bar

Aluminum								
PART	VEHICLE							
1630-TCX	FORD TRANSIT CONNECT	135", 155"	Standard	73" W × 94.5" L × 16.5" H	480 lbs	59 lbs	28 ft	1.6 hrs
1630-PCX	RAM PROMASTER CITY	122"	Standard	73" W × 97" L × 16.5" H	480 lbs	59 lbs	28 ft	1.6 hrs

SEE PAGE 212 FOR SUB-UNIT

VAN ROOF RACKS – MAX RACK

1840 SERIES

MAX RACK LOW ROOF - SINGLE DESIGNED FOR LOW ROOF VANS









1840-FTL SHOWN HERE

Individual models may vary to accommodate each vehicle and may be different.

Max Rack Low Roof Single Side

Aluminum

PART	VEHICLE							
1840-GS	CHEVROLET EXPRESS	135", 155"	Standard	76.5" W × 113.5" L × 16.5" H	480 lbs	78 lbs	32 ft	1.4 hrs
1840-FTL	FORD TRANSIT	148", 148" Ext	Low	76.5" W × 120.5" L × 15" H	480 lbs	85 lbs	32 ft	1.7 hrs
1840-FTR	FORD TRANSIT	130"	Low	76.5" W × 113.5" L × 15" H	480 lbs	84 lbs	32 ft	1.7 hrs
1840-GS	GMC SAVANA	135", 155"	Standard	76.5" W × 113.5" L × 16.5" H	480 lbs	78 lbs	32 ft	1.4 hrs
1840-MM	MERCEDES-BENZ METRIS	126", 135"	Standard	70.5" W × 101.5" L × 15.5" H	480 lbs	82 lbs	28 ft	1.7 hrs



1850 SERIES

MAX RACK

LOW ROOF - DOUBLE

DESIGNED FOR LOW ROOF VANS



1850-FTR SHOWN HERE

Individual models may vary to accommodate each vehicle and may be different.

Max Rack Low Roof Double Side – 2 Bar

Aluminum								
PART	VEHICLE							
1850-GS	CHEVROLET EXPRESS	135", 155"	Standard	80.5" W x 113.5" L x 16.5" H	480 lbs	136 lbs	32 ft	2.2 hrs
1850-FTL	FORD TRANSIT	148", 148" Ext	Low	80.5" W x 120.5" L x 15" H	480 lbs	143 lbs	32 ft	2.5 hrs
1850-FTR	FORD TRANSIT	130"	Low	80.5" W x 113.5" L x 15" H	480 lbs	141 lbs	32 ft	2.5 hrs
1850-GS	GMC SAVANA	135", 155"	Standard	80.5" W x 113.5" L x 16.5" H	480 lbs	136 lbs	32 ft	2.2 hrs
1850-MM	MERCEDES-BENZ METRIS	126", 135"	Standard	75" W x 101.5" L x 15.5" H	480 lbs	140 lbs	28 ft	2.5 hrs

Max Rack Low Roof Double Side – 3 Bar

Aluminum								
PART	VEHICLE							
1850-GS3	CHEVROLET EXPRESS	135", 155"	Standard	80.5" W x 113.5" L x 16.5" H	720 lbs	146 lbs	32 ft	2.4 hrs
1850-FTL3	FORD TRANSIT	148", 148" Ext	Low	80.5" W x 120.5" L x 15" H	720 lbs	151 lbs	32 ft	2.7 hrs
1850-FTR3	FORD TRANSIT	130"	Low	80.5" W x 113.5" L x 15" H	720 lbs	149 lbs	32 ft	2.7 hrs
1850-GS3	GMC SAVANA	135", 155"	Standard	80.5" W x 113.5" L x 16.5" H	720 lbs	146 lbs	32 ft	2.4 hrs
1850-MM3	MERCEDES-BENZ METRIS	126", 135"	Standard	75" W x 101.5" L x 15.5" H	720 lbs	147 lbs	28 ft	2.7 hrs

The number 3 refers to the number of bars.

SEE PAGE 212 FOR SUB-UNIT

VAN ROOF RACKS – MAX RACK 2.0

1870 – 1880 SERIES

MAX RACK 2.0

DESIGNED FOR HIGH ROOF VANS

Makes loading and unloading ladders an easy operation.



THE EVOLUTION OF OUR DROP DOWN LADDER RACK

TOUGH

- › Military grade aluminum and stainless steel components.
- › No corrosion over the lifetime of the rack.

Only ladder rack with a 3 year warranty

SAFE

- › Easy access from ground.
- › Lower profile on roof.
- › Each mechanism has a weight capacity of 100 lbs (both single and double).

SIMPLE

- › Single stage operation for fast loading and unloading of ladders on high roof vans.

MAX RACK 2.0 IS FAST AND EASY TO OPERATE

LOWER LADDER

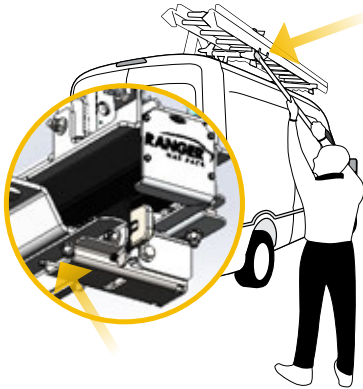

1

STEP ONE

Release positive lock before operating the rack.



2

STEP TWO

With both hands, insert the handle into the Max Rack and turn to secure.

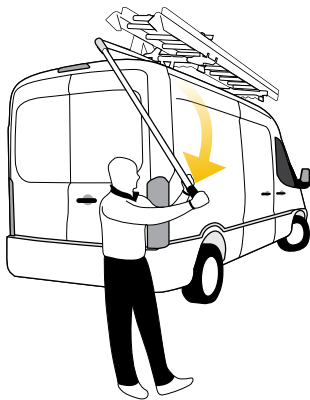

3

STEP THREE

Pull the handle down towards you.

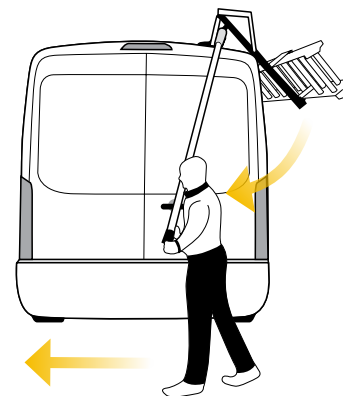

4

STEP FOUR

Turn around. Push the handle forward.

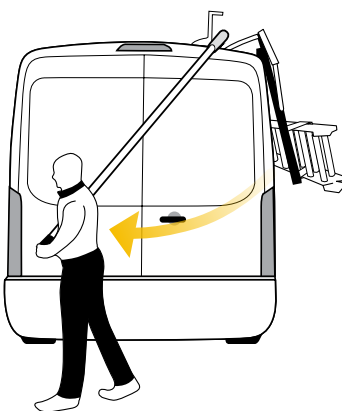

5

STEP FIVE

Continue to push the handle until the Max Rack has finished its descent. Do not let go of handle until ladder has fully descended.

RAISE LADDER

1

STEP ONE

Push the handle, don't pull it.

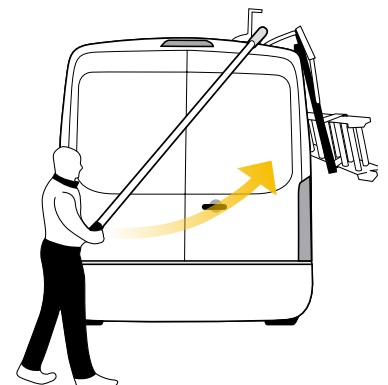

VAN ROOF RACKS – MAX RACK 2.0

1870 SINGLE MAX RACK







fast and easy access to an extension or step ladder with extra room for additional cargo.



1870-FTR SHOWN HERE.
Individual models may vary to accommodate each vehicle and may be different.

Single Side Max Rack 2.0 – 2 bar

Aluminum

PART	VEHICLE							
1870-DH	MERCEDES-BENZ SPRINTER	144", 170", 170" Ext	High	76.5" W x 137.5" L x 17.5" H	480 lbs	102 lbs	32 ft	2 hrs
1870-FTL	FORD TRANSIT	148", 148" Ext	Medium, High	76.5" W x 125.5" L x 17" H	480 lbs	100 lbs	32 ft	2 hrs
1870-FTR	FORD TRANSIT	130"	Medium	76.5" W x 113.5" L x 17" H	480 lbs	98 lbs	28 ft	2 hrs
1870-NH	NISSAN NV	146"	High	76.5" W x 102" L x 16" H	480 lbs	100 lbs	24 ft	2 hrs
1870-PHL	RAM PROMASTER	159"	High	76.5" W x 151.5" L x 17" H	480 lbs	104 lbs	32 ft	2 hrs
1870-PHM	RAM PROMASTER	136"	Standard, High	76.5" W x 130" L x 17" H	480 lbs	101 lbs	32 ft	2 hrs
1870-PHS	RAM PROMASTER	118"	Standard	76.5" W x 113.5" L x 17" H	480 lbs	99 lbs	28 ft	2 hrs
1870-PHX	RAM PROMASTER	159" Ext.	High	76.5" W x 162.5" L x 17" H	480 lbs	105 lbs	32 ft	2 hrs







1880 DOUBLE MAX RACK

an ergonomic choice to store two extension or step ladders on a high roof vehicle.









1880-FTR SHOWN HERE.
Individual models may vary to accommodate each vehicle and may be different.

Double Side Max Rack 2.0 – 2 bar

Aluminum								
PART	VEHICLE							
1880-DH	MERCEDES-BENZ SPRINTER	144", 170", 170" Ext	High	81" W x 137.5" L x 17.5" H	480 lbs	174 lbs	32 ft	3 hrs
1880-FTL	FORD TRANSIT	148", 148" Ext	Medium, High	81" W x 125.5" L x 17" H	480 lbs	172 lbs	32 ft	3 hrs
1880-FTR	FORD TRANSIT	130"	Medium	81" W x 113.5" L x 17" H	480 lbs	170 lbs	32 ft	3 hrs
1880-NH	NISSAN NV	146"	High	81" W x 102" L x 16" H	480 lbs	173 lbs	24 ft	3 hrs
1880-PHL	RAM PROMASTER	159"	High	81" W x 151.5" L x 17" H	480 lbs	176 lbs	32 ft	3 hrs
1880-PHM	RAM PROMASTER	136"	Standard, High	81" W x 130" L x 17" H	480 lbs	173 lbs	32 ft	3 hrs
1880-PHS	RAM PROMASTER	118"	Standard	81" W x 113.5" L x 17" H	480 lbs	171 lbs	28 ft	3 hrs
1880-PHX	RAM PROMASTER	159" Ext.	High	81" W x 162.5" L x 17" H	480 lbs	177 lbs	32 ft	3 hrs

Double Side Max Rack 2.0 – 3 bar

Aluminum								
PART	VEHICLE							
1880-DH3	MERCEDES-BENZ SPRINTER	144", 170", 170" Ext	Standard, High	81" W x 137.5" L x 17.5" H	720 lbs	182 lbs	32 ft	3.2 hrs
1880-FTL3	FORD TRANSIT	148", 148" Ext	Medium, High	81" W x 125.5" L x 17" H	720 lbs	180 lbs	32 ft	3.2 hrs
1880-FTR3	FORD TRANSIT	130"	Medium	81" W x 113.5" L x 17" H	720 lbs	178 lbs	32 ft	3.2 hrs
1880-PHL3	RAM PROMASTER	159"	High	81" W x 151.5" L x 17" H	720 lbs	184 lbs	32 ft	3.2 hrs
1880-PHM3	RAM PROMASTER	136"	Standard, High	81" W x 130" L x 17" H	720 lbs	181 lbs	32 ft	3.2 hrs
1880-PHS3	RAM PROMASTER	118"	Standard	81" W x 113.5" L x 17" H	720 lbs	179 lbs	28 ft	3.2 hrs
1880-PHX3	RAM PROMASTER	159" Ext.	High	81" W x 162.5" L x 17" H	720 lbs	186 lbs	32 ft	3.2 hrs

The number 3 refers to the number of bars.

VAN ROOF RACKS – DOUBLE CLAMP RACK

1920 SERIES ACCESS STOW DESIGNED FOR HIGH ROOF VANS









1920-FTR SHOWN HERE.

Individual models may vary to accommodate each vehicle and may be different.

Access Stow Single

Aluminum

PART	VEHICLE							
1920-FTL	FORD TRANSIT	148", 148" Ext	Medium, High	74" W × 127" L × 19.5" H	720 lbs	163 lbs	32 ft	2.2 hrs
1920-FTR	FORD TRANSIT	130"	Medium, High	74" W × 127" L × 19.5" H	720 lbs	161 lbs	32 ft	2.2 hrs
1920-DH	MERCEDES-BENZ SPRINTER	144", 170", 170" Ext	Standard, High	74" W × 128.5" L × 20" H	720 lbs	165 lbs	32 ft	2.2 hrs
1920-PHS	RAM PROMASTER	118"	Standard	74" W × 127" L × 18.5" H	720 lbs	162 lbs	28 ft	2.2 hrs
1920-PHM	RAM PROMASTER	136"	Standard, High	74" W × 127" L × 18.5" H	720 lbs	164 lbs	32 ft	2.2 hrs
1920-PHL	RAM PROMASTER	159"	High	74" W × 147.5" L × 18.5" H	720 lbs	168 lbs	32 ft	2.2 hrs
1920-PHX	RAM PROMASTER	159" Ext	High	74" W × 161" L × 18.5" H	720 lbs	169 lbs	32 ft	2.2 hrs

VAN ROOF RACKS – DOUBLE CLAMP RACK

TOUGH

- Built from sturdy aluminum.
- Durable polyester straps keep the ladders secure.

SAFE

- The rack slides down to ground level, eliminating the need to stretch or climb onto the van roof.
- Each mechanism has a weight capacity of 130 lbs (both single and double).

SIMPLE

- The mechanism is designed to make loading and unloading, a quick and easy process.

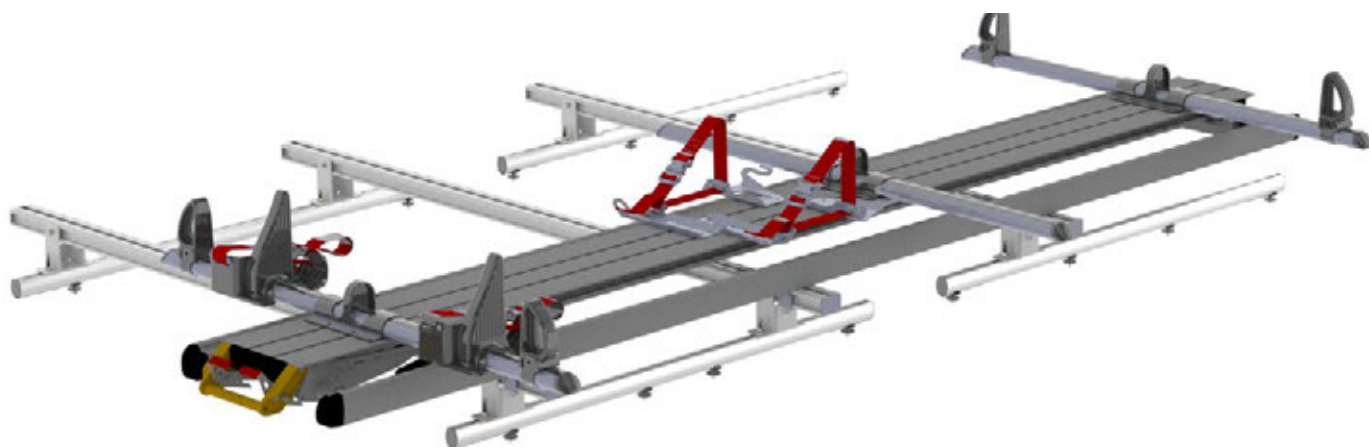







1930-DH SHOWN HERE.

Individual models may vary to accommodate each vehicle and may be different.

Acces Stow Double

Aluminum

PART	VEHICLE							
1930-FTL	FORD TRANSIT	148", 148" Ext	Medium, High	85" W × 127" L × 19.5" H	720 lbs	185 lbs	32 ft	2.2 hrs
1930-FTR	FORD TRANSIT	130"	Medium, High	85" W × 127" L × 19.5" H	720 lbs	184 lbs	32 ft	2.2 hrs
1930-DH	MERCEDES-BENZ SPRINTER	144", 170", 170" Ext	Standard, High	85" W × 128.5" L × 20" H	720 lbs	188 lbs	32 ft	2.2 hrs
1930-PHS	RAM PROMASTER	118"	Standard	85" W × 127" L × 18.5" H	720 lbs	185 lbs	28 ft	2.2 hrs
1930-PHM	RAM PROMASTER	136"	Standard, High	85" W × 127" L × 18.5" H	720 lbs	186 lbs	32 ft	2.2 hrs
1930-PHL	RAM PROMASTER	159"	High	85" W × 147.5" L × 18.5" H	720 lbs	190 lbs	32 ft	2.2 hrs
1930-PHX	RAM PROMASTER	159" Ext	High	85" W × 161" L × 18.5" H	720 lbs	191 lbs	32 ft	2.2 hrs

SEE PAGE 212 FOR SUB-UNIT

1506 SERIES CARGO +

PART	VEHICLE	SIDE RAILS	BAR	ROLLER	KIT
1506-FTR	FORD TRANSIT LR 130"	15-U1002	15-U2002	15-U3002	15-U4006
1506-FTL	FORD TRANSIT LR 148"	15-U1003	15-U2002	15-U3002	15-U4005
1506-FTX	FORD TRANSIT 148" Ext	15-U1005	15-U2002	15-U3002	15-U4010
1506-TC	FORD TRANSIT CONNECT 120"	15-U1000	15-U2000	15-U3000	15-U4000
1506-GS	GM SAVANA / EXPRESS RWB	15-U1003	15-U2002	15-U3002	15-U4011
1506-MM	MERCEDES-BENZ METRIS 126"	15-U1001	15-U2001	15-U3001	15-U4001
1506-M	MERCEDES-BENZ METRIS 135"	15-U1002	15-U2001	15-U3001	15-U4001
1506-DS	MERCEDES-BENZ SPRINTER 144"	15-U1002	15-U2002	15-U3002	15-U4002
1506-DH	MERCEDES-BENZ SPRINTER 170", 170" Ext	15-U1005	15-U2002	15-U3002	15-U4012
1506-NL	NISSAN NV LR	15-U1002	15-U2002	15-U3002	15-U4007
1506-NH	NISSAN NV HR	15-U1000	15-U2002	15-U3002	15-U4007
1506-NS	NISSAN NV200	15-U1000	15-U2000	15-U3000	15-U4008
1506-PHS	RAM PROMASTER 118"	15-U1001	15-U2002	15-U3002	15-U4004
1506-PHM	RAM PROMASTER LR 136"	15-U1002	15-U2002	15-U3002	15-U4004
1506-PHL	RAM PROMASTER 159"	15-U1003	15-U2002	15-U3002	15-U4009
1506-PHX	RAM PROMASTER 159" Ext	15-U1005	15-U2002	15-U3002	15-U4009
1506-PC	RAM PROMASTER CITY	15-U1000	15-U2000	15-U3000	15-U4003

1605 SERIES CARGO RACK

PART	DESCRIPTION
16-U005	Cargo rack kit for 1 crossbar - 2 × End stops, 2 × Tie-Downs & 72" Track Plug

1630 SERIES CLAMP RACK

PART	DESCRIPTION
16-U1127	Step Laddered Kit
16-UCL65	Universal side Short Ski and Mechanism Kit
16-UCL77	Universal side Long Ski and Mechanism Kit
16-UFB03	3 rd Bar Fastener Kit for Clamp Rack



1840 SERIES MAX RACK LOW ROOF

PART	DESCRIPTION
16-U1820	Passenger Side Low Roof Max Rack
16-U1825	Driver Side Low Roof Max Rack

UNIVERSAL CROSSBAR KIT

PART	DESCRIPTION
16-UCD60	Set of two Crossbars 60" wide, Includes mounting feet
16-UCD66	Set of two Crossbars 66" wide, Includes mounting feet
16-UCD72	Set of two Crossbars 72" wide, Includes mounting feet <i>(Replacing 18-U1806)</i>
16-UCD6S	Set of two Crossbars 72" wide, Includes GM Savana mounting feet
16-UCS60	Single Crossbar 60" with feet
16-UCS66	Single Crossbar 66" with feet
16-UCS72	Single Crossbar 72" with feet <i>(Replacing 18-U1805)</i>
16-UCS6S	Single Crossbar 72" with feet for GM SAVANA / EXPRESS
16-UCT60	Single Crossbar 60" no feet

1870 – 1880 SERIES MAX RACK 2.0

PART	DESCRIPTION
18-U1810	Passenger side mechanism
18-U1815	Driver side mechanism
18-U1807	Handle

1920 SERIES ACCES STOW

PART	DESCRIPTION
19-U0001	Rear loader single width bracket
19-U0002	Rear loader double width bracket
19-U0003	Rear loader mechanism carriage

UNIVERSAL MOUNTING KIT

PART	DESCRIPTION
18-U0010	Mounting kit NISSAN NV
18-U0018	Mounting kit MERCEDES-BENZ SPRINTER
18-U0019	Mounting kit SPRINTER WITH OEM TRACKS
18-U0020	Mounting kit RAM PROMASTER 118"
18-U0022	Mounting kit RAM PROMASTER 136"
18-U0030	Mounting kit FORD TRANSIT 148"
18-U0032	Mounting kit RAM PROMASTER 159"
18-U0034	Mounting kit RAM PROMASTER 159" Ext.
18-U0042	Mounting kit FORD TRANSIT 130"
18-U0043	Mounting kit MERCEDES-BENZ METRIS
18-U0045	Mounting kit RAM PROMASTER CITY
18-U0046	Mounting kit FORD TRANSIT CONNECT/NV200
18-U0047	Mounting Kit, Set of 2 Universal Bolt Through foot mounts