



BDRAS 160-60 Radial Fans

Material
 Cast Aluminum body and thruster
 Galvanized Steel is produced using

Insulation Class
 B

Certifications
 -

Engine Protection
 IP44

Speed Control
 -

Usage Areas
 -

Technical Parameters

Nominal Data

Voltage (nominal)	230V
Frequency	50Hz
Phase	1Ph
Input Power	0.2W
Shaft Power	0kW
Maximum Shaft Power	-kW
Current	0.88A
Impeller Speed	2250d/d
Air Flow	600m³/h
Capacitor	-μF
Engine Speed	2250d/d
IP Class	IP44
Insulation Class	B
Impulse	BN
Sfp Nominal	0kW/m³/s
Weight	-Kg
Maximum Transportable Air Temperature	-20°C / +40°C

Sound Data

3m sound pressure (21m ² Room)	0dB(A)
4m sound pressure (Open Area)	0dB(A)
10m sound pressure (Open Area)	0dB(A)

Preservation and Classification

Pole	2
Motor Connection	0
Engine Type	DRM
Motor Power	-
Motor Input Power	-
Nominal Motor current	-
Maximum Current Drawn	-
Inrush Current	0
Engine Efficiency	IE1
Atex Explosion Class Label	0

Additional

Channel Connection Type	Dikdörtgen
Outlet Dimensions	-
Fan Diameter	-
Number of Wings	0
Wing Angle	-
Temperature Resistance	-20/40
Air Outlet Velocity	0

Wiring Diagram

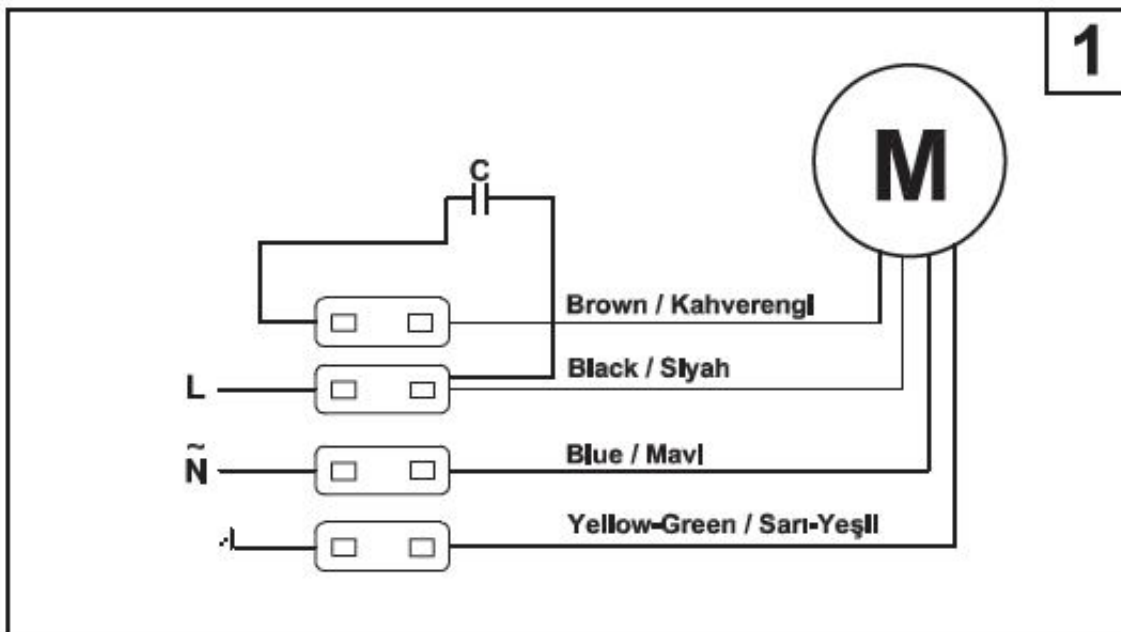

Description and Features