



S T E P S T O S E T U P

REVIV3HACK®

Welcome, Hacker, to the guide for setting up your brand-new ReviveHeat Sauna!

If this is your inaugural setup, anticipate spending about 15-20 minutes. But don't worry, once you've got the hang of it, future assemblies will be a breeze! Let's get started on this simple and straightforward journey.

Quick Tip:

Best Environment to Use It

You can enjoy the ReviveHeat Sauna in any location, but for optimal heating efficiency, we suggest using it in areas with a minimum temperature of 70°F. Warmer environments help the sauna heat up more quickly, ensuring you can relax and unwind without the wait.



For Video Instructions

Attention

Product Introduction

Specifications

Sauna Components and Parts List

What's in the box

Sauna Assembly Instructions

Regular use of the Sauna

How to clean Sauna

Warranty Information

Step-by-Step Assembly Guide for Portable Sauna:

**PLEASE READ THE MANUAL CAREFULLY
BEFORE YOU START USING THE PRODUCT.**

Attention

You are strongly encouraged to read through the following warnings and instructions before using Portable Home Sauna ("Product"). Your failure to do so affects the Limited Warranty and may also result in damage to the product not covered under the warranty.

To prevent injury to users, others and/or property damage, the following safety instructions must be followed. Ignoring these instructions may cause harm or damage due to faulty operation.



Caution and Warning

Electrical Safety:

- 1** Unplug the power cord after each use.
- 2** Do not use in or around water due to the danger of electrical shock.
- 3** Keep the electrical cord away from heat sources.
- 4** Never operate the unit if the cord or plug has been damaged.
- 5** Do not pull on the electrical cord.
- 6** Any repair must be performed by the manufacturer, its service agent, or a similarly qualified person.
- 7** Never use in wet or damp conditions!

Safety Precautions:

- 1** This sauna is not a medical device and is not intended for medical purposes.
- 2** Please do not unscrew the cover while the machine is working to prevent steam burns.
- 3** Please do not connect non-temperature-resistant tubes to avoid unnecessary trouble.
- 4** Check with your doctor before using this sauna if pregnant or under medical care.
- 5** Stop using the sauna immediately if you feel discomfort, nausea, or sleepy.

Safety Precautions:

- 6** Do not plug in while folded for storage.
- 7** Staying too long in the sauna can cause overheating. It is recommended not to use the sauna for over 30 minutes per day and not more than 3 times per week.
- 8** Not recommended for use by anyone under 18 years of age.
- 9** Do not use the sauna under any of the following health conditions: Any type of respiratory condition. Anyone with a heart condition. High or low blood pressure. Pregnancy. Any skin disease or disorders. After or during drinking alcohol or alcoholic beverages.
- 10** Check with your doctor regarding the use of this product.

Handling Precautions:

- 1** Hyperthermia occurs when the internal temperature of the body reaches a level several degrees above the normal body temperature of 98.6°F (37°C). Symptoms include an increase in internal body temperature, dizziness, lethargy, drowsiness, and fainting.

Cleaning and Maintenance:

- 1** Unplug the power cord after each use.
- 2** After use, always wipe down the inside cover with a dry cloth; never put the sauna away while it is damp.
- 3** Do not use in or around water due to the danger of electrical shock.

Power Supply:

- 1** Use the main power supply of 220V-240V. Only use original cables for the sauna box, and ensure you use a GFCI outlet for the Steam generator's power cord.

Certifications:

- 1** Certified by CE, RoHS.

Congratulations on your purchase of our personal steam sauna, another one of our personal care products. We appreciate your business, and we hope that you are completely satisfied with your purchase. Introducing Portable Home Sauna – your key to immediate relaxation and wellness. Enjoy a tranquil escape with our innovative design, providing therapeutic benefits for both body and mind.

Steam Generator



REVIVEHACK®

Product Introduction

Upon Receiving the Product:

Safety Precautions:

- A One-piece stretch-formed stainless steel liner**
- A Anti-dry, explosion-proof, anti-leakage**
- A Water shortage "Drip" alarm**
- A The inner liner is thick and not easy to rupture**
- A High power heating, 9-speed adjustment**

When the product is removed from the package, the cover is buckled on the machine's inner casing. Please overturn the bottom of the machine, then you can take it off with your hand on the lid. Accessories such as kits and remote controls are generally placed in the liner; please do not twist the screws on the grid. Also, do not remove the grid (the left cover is a schematic for reference only. Please, subject to the actual object). The grid is used to block debris from plugging out the steam hole.







REVIVERHACK®

Product Introduction

Upon Receiving the Product:

Warning Statements:

-  It means the cover is tightened (the cover is twisted in the end, the white groove is completely exposed).
-  The raised round hat is a pressure relief valve (explosion-proof), it is a kind of security measure.
-  Please tighten the cover in the direction of the arrow.
-  Please do not unscrew the cover while the machine is working to prevent steam burns.
-  Please do not connect non-temperature-resistant tubes to avoid unnecessary trouble.

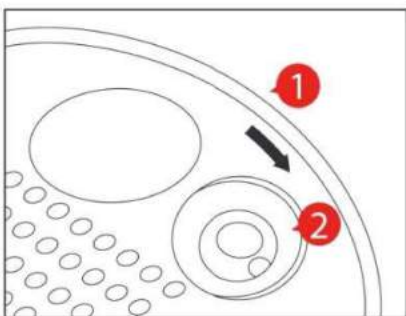

REVIVEHACK®

Product Introduction

Upon Receiving the Product:

Pill Box Analysis:

The pill box is used for placing essential oils, so the box can be opened.

- 1 The top cover of the pill box.
- 2 The bottom case of the pill box.
- 3 The medicine package of the compartment.

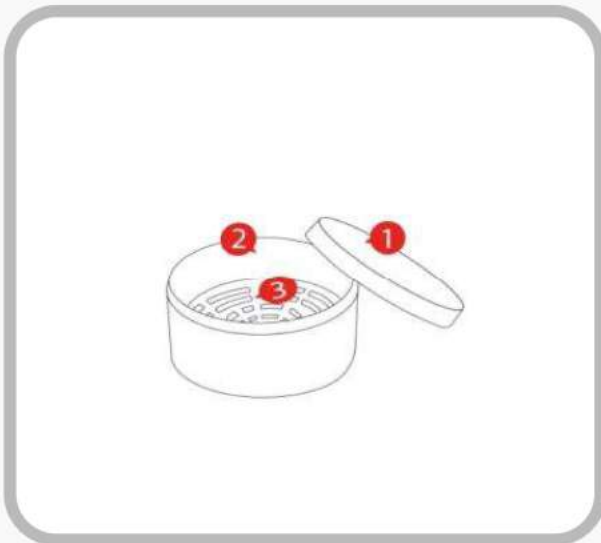

The essential oil must be placed on the compartment; do not put on the bottom to avoid affecting the steaming tablets. Flakes need to be placed in the grid and then tightened.

(The hole in the bottom of the kit is designed because the water vapor will form condensation when it is condensed into water, and the water will affect the steam hole.

REVIVEHACK®

Specifications

Parameter

Sauna Tent

Material

Polyester, Cotton Fabric, PVC coating

Size

Height 180/70.87inch
Max inside length 90cm/35.43inch
Max inside Width 90cm/35.43inch

Steam generator (220V/50HZ)

Voltage

220V-240V

Wattage

1500-2000W

Heat Level

1-9 gear

Maximum Temperature

55°C

Time Settings

5-99 mins

Dimensions

H27×W23×H30cm

Weight

1.8/2.5kg

Steam generator (110V/60HZ)

Voltage

110V-120V

Wattage

1500W

Heat Level

1-9 gear

Maximum Temperature

122F

Time Settings

5-99 mins

Dimensions

L10.63×W9×H9inch

Weight

4LB

REVIVEHACK®

Sauna Components and Parts List

What's in the box

1 Sauna Tent

2 Sauna Mat

Detachable frame

3 39 Metal Frame Pieces
(Requires Assembly)

4 Foldable Chair

5 4.2L Steamer

6 2x Steam Hose

7 Pill box

8 Remote Control

9 Hose Connector

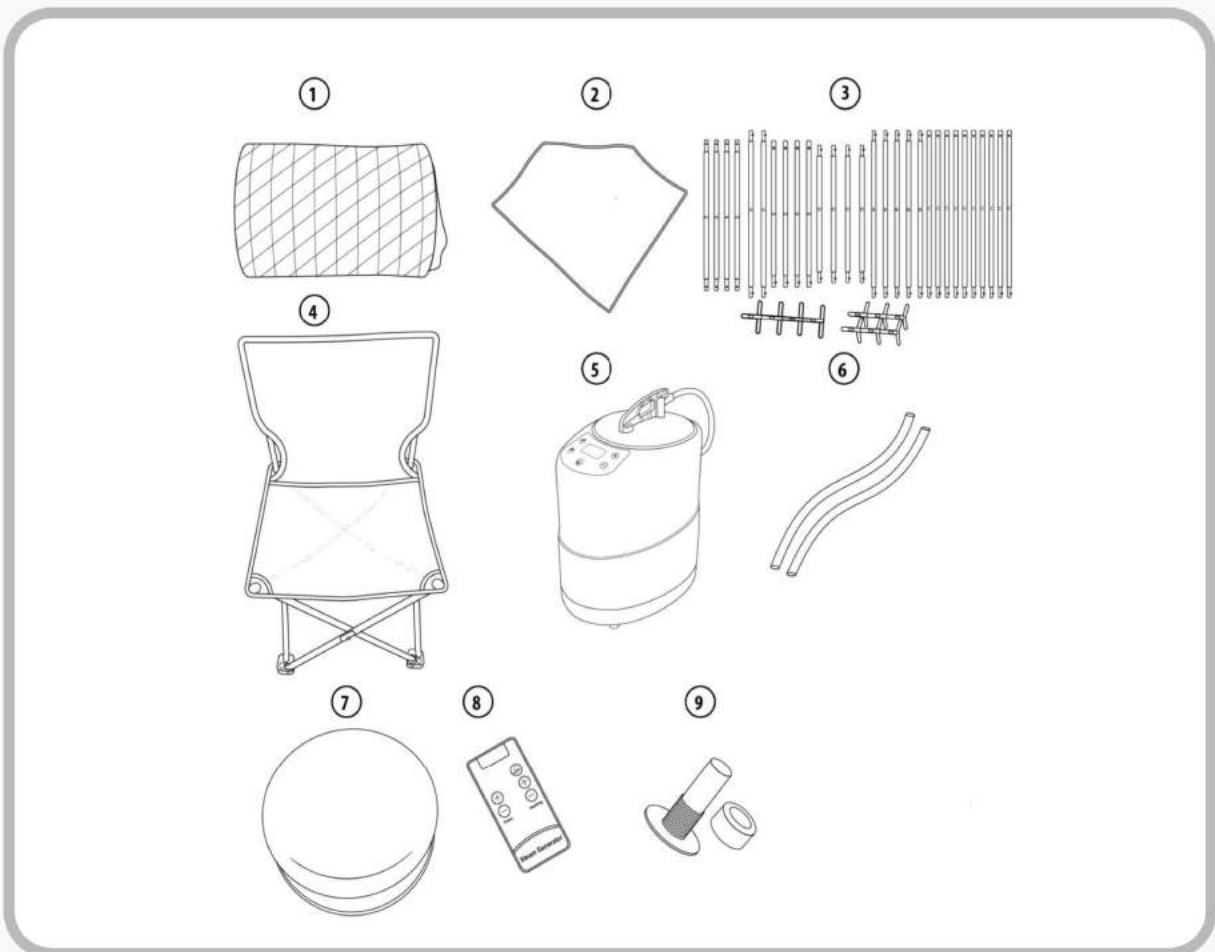

REVIVĒHACK®

Sauna Assembly Instructions

Phase 1: Frame Assembly

Before You Begin:

Ensure you have all the metal tubes components listed

A Tube * 8 pcs

B Tube * 4 pcs

C Tube * 2 pcs

D Tube * 4 pcs

1 Tube * 6 pcs

2 Tube * 5 pcs

3 Tube * 4 pcs

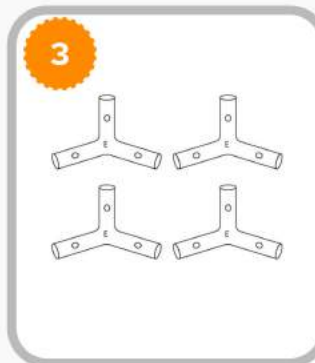
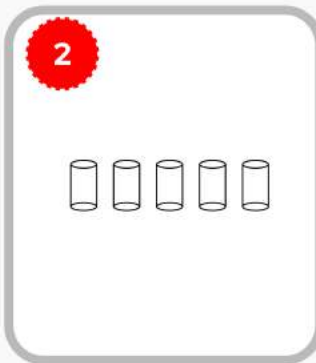
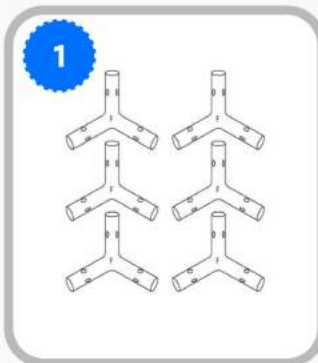
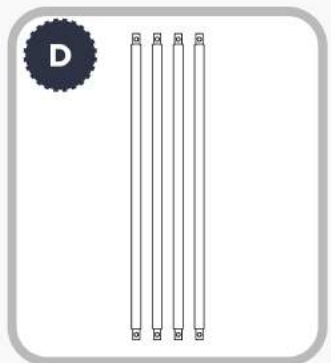
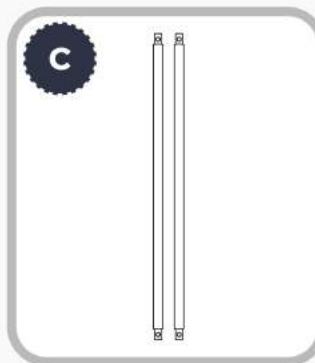
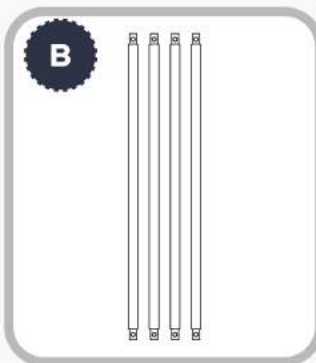
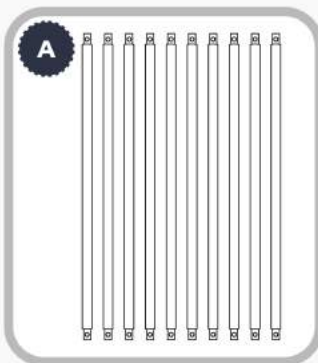

Lay out all parts in an organized manner for easy access.

REVIVEHACK®

Step 1

Assemble the Bottom Structure

Follow the diagram below when connecting the tubes to create the bottom structure.

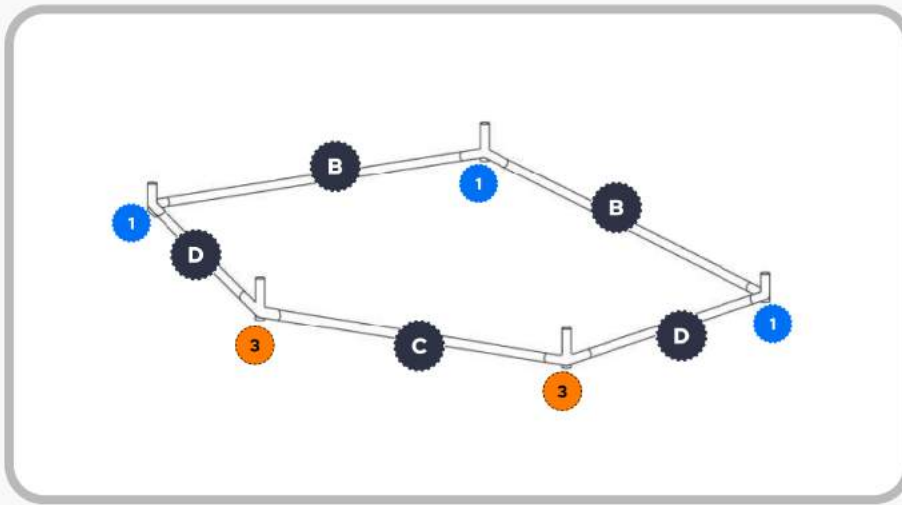

(Note: Repeat this process for the top structure, as it has the same build.)

Quick Tip

The top and bottom structures are interchangeable, meaning you can use the same assembly process for both.

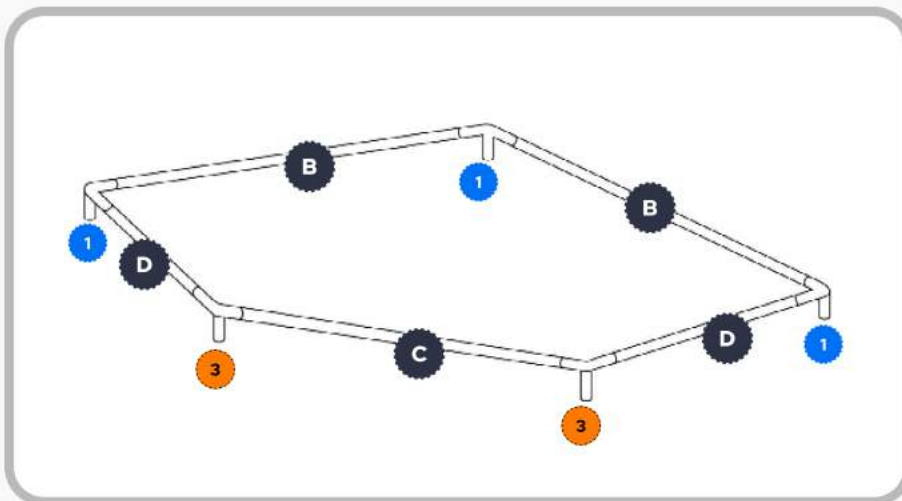

REVIVEHACK®

Step 2

Assemble the Side Structure:

Connect all B tubes and C tubes vertically, starting with a B followed by 2 Cs connected under. This will be used on the 5 corners of the sauna. Also, make sure the C tubes are facing downwards so the B tube connects. Once the side structure parts are complete, place it on a flat surface.

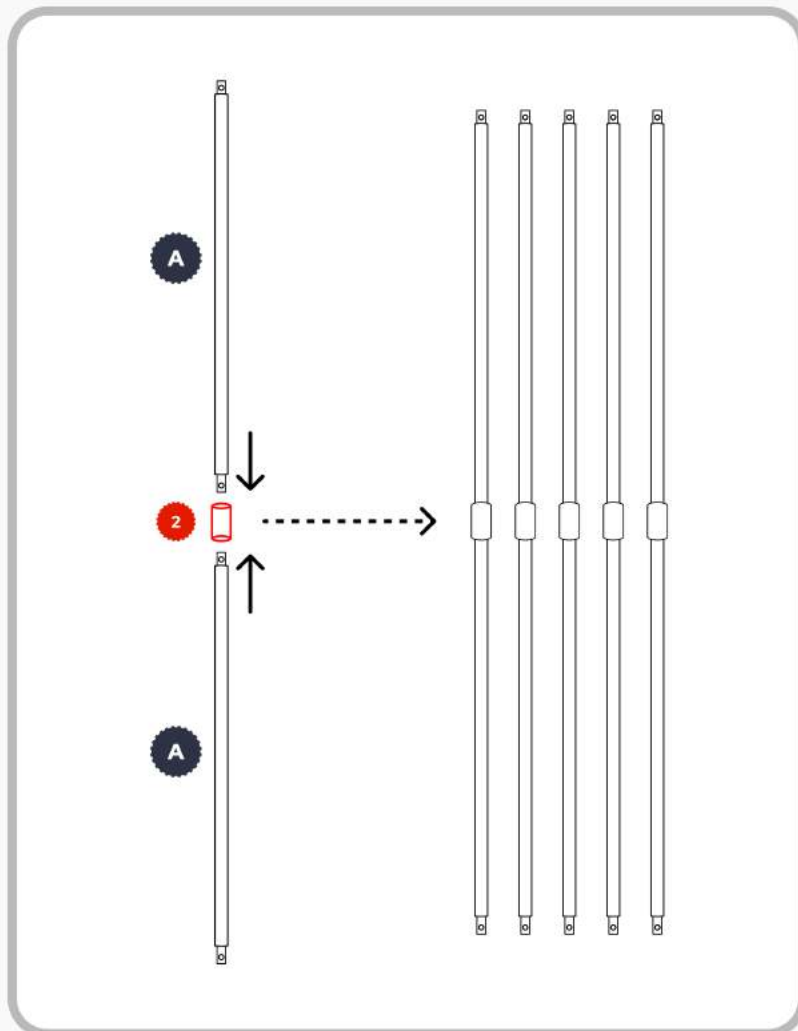

Step 3

Insert the Side Structure Parts into the Bottom Structure

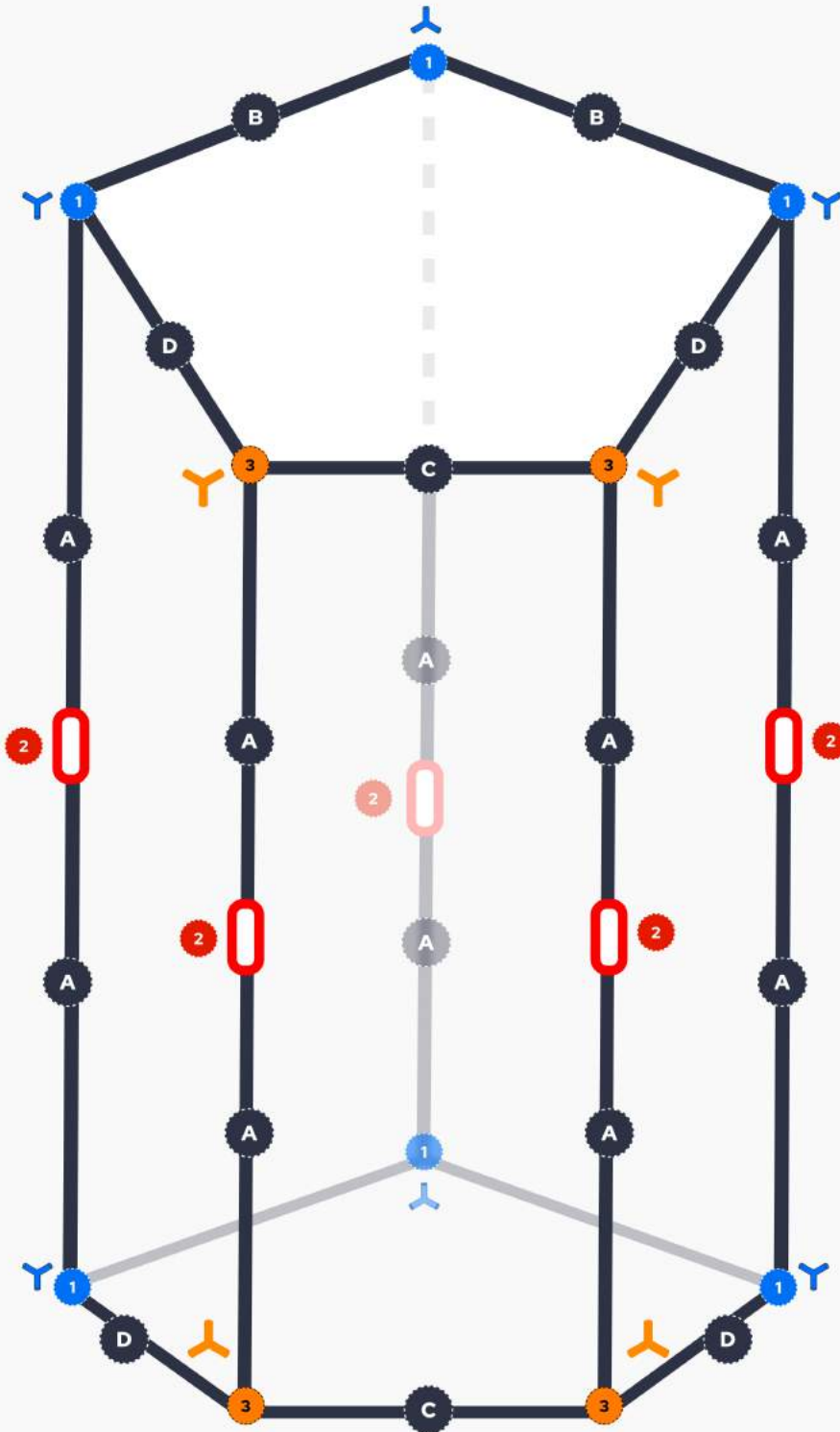

Step 3

Insert the Side Structure Parts into the Bottom Structure

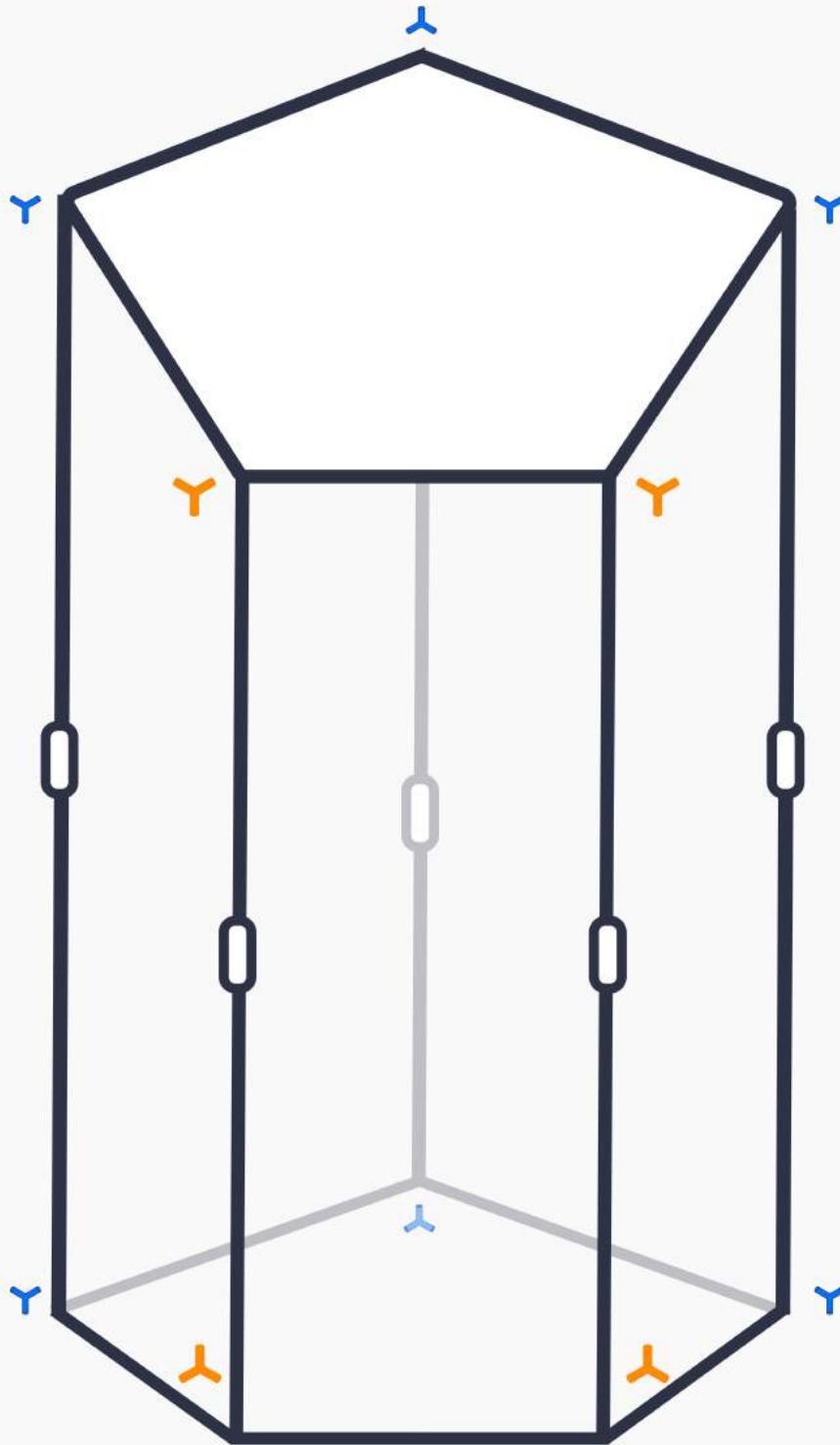

Step 1

- 1** Carefully place the frame structure created into the sauna tent floor. Ensure that the tent aligns with every corner of the frame structure.
- 2** Remember to add the sauna mat before after placing frame structure, ensuring it is properly aligned fitting to every corner.

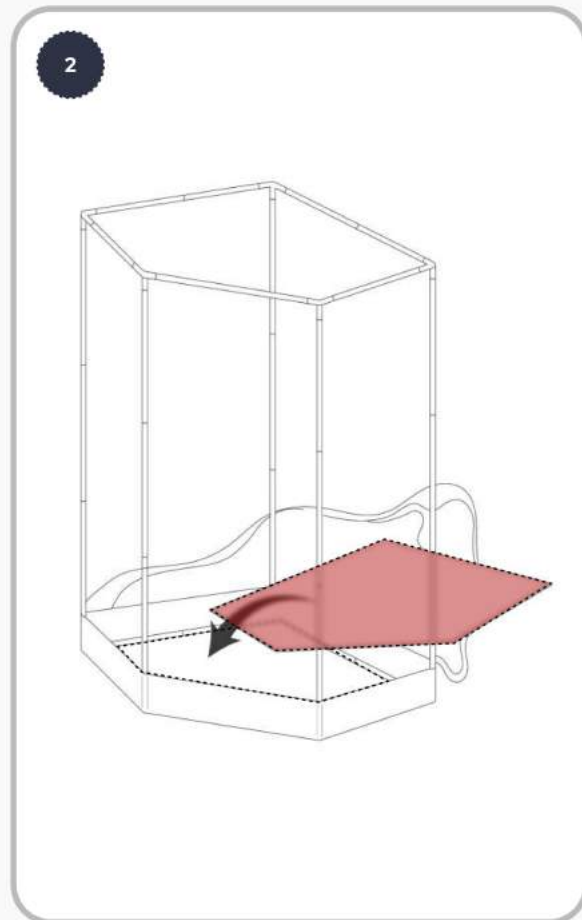
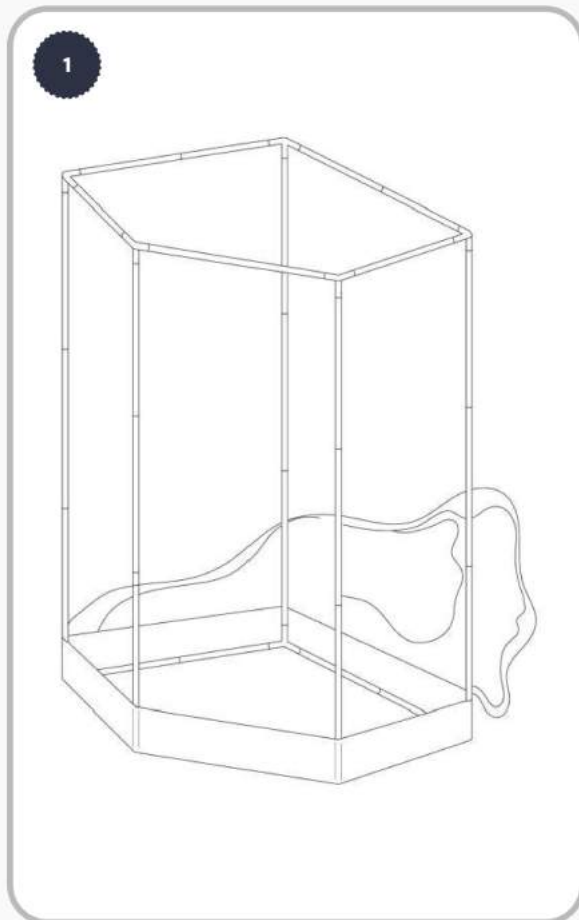

Phase 2

Attaching the Sauna Tent

Step 2

3 Lift the cover to the top as shown in the diagram below.

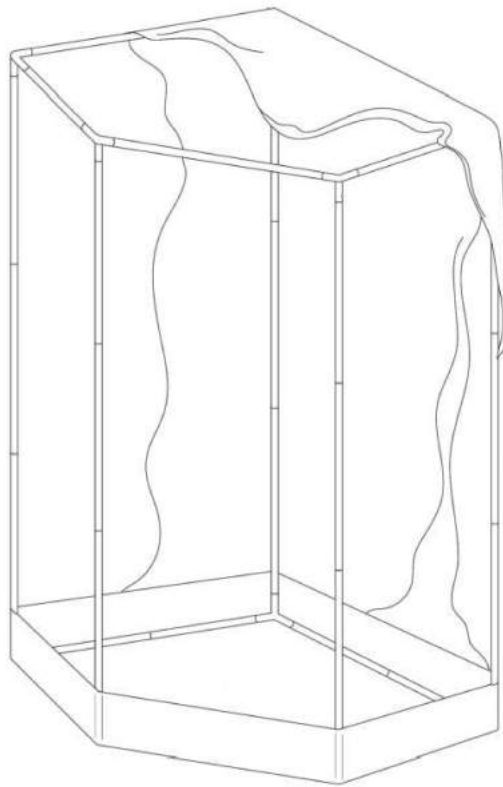

Step 3

- 4 Now use the fold of the sauna tent to fit to all top frames accordingly, as the images show.

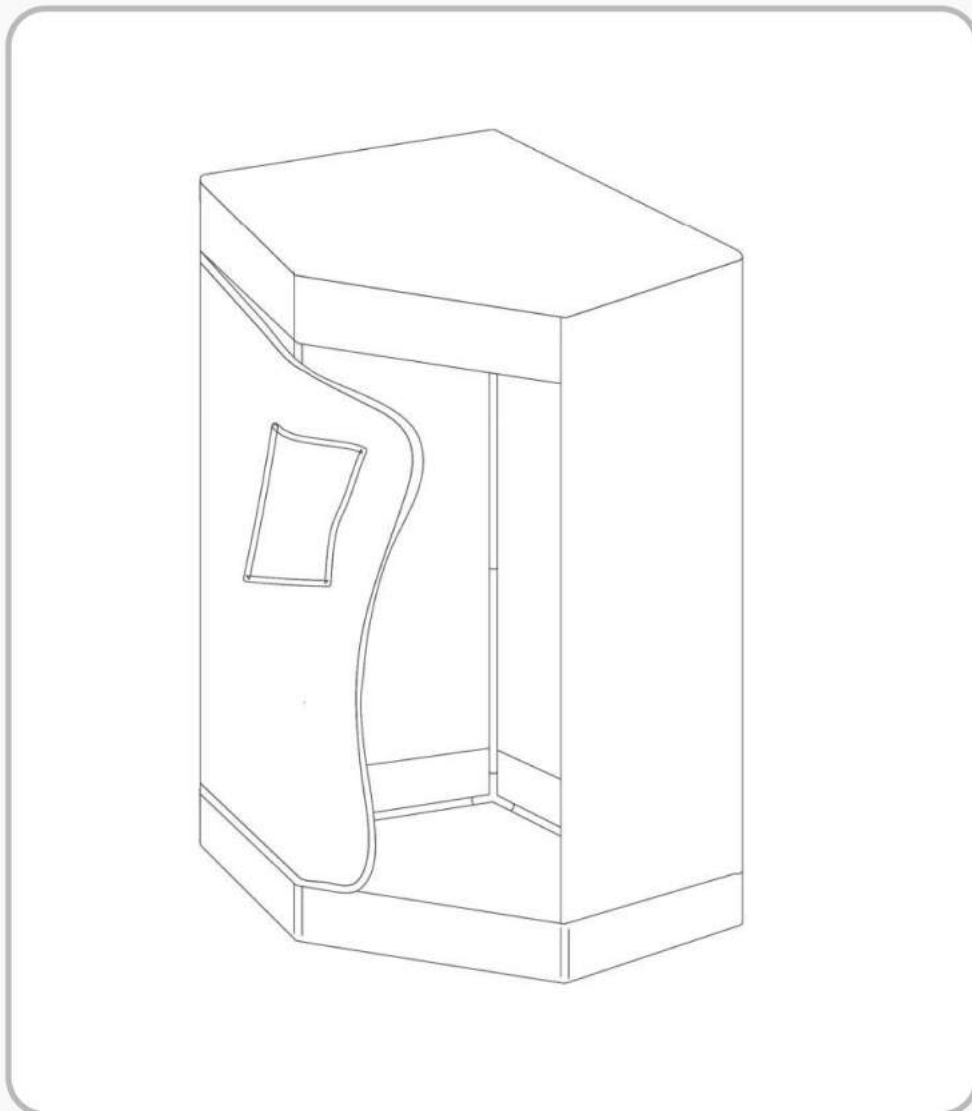

Step 4

- 5 After doing this, now all that remains is zipping the sauna tent to complete the assembly.

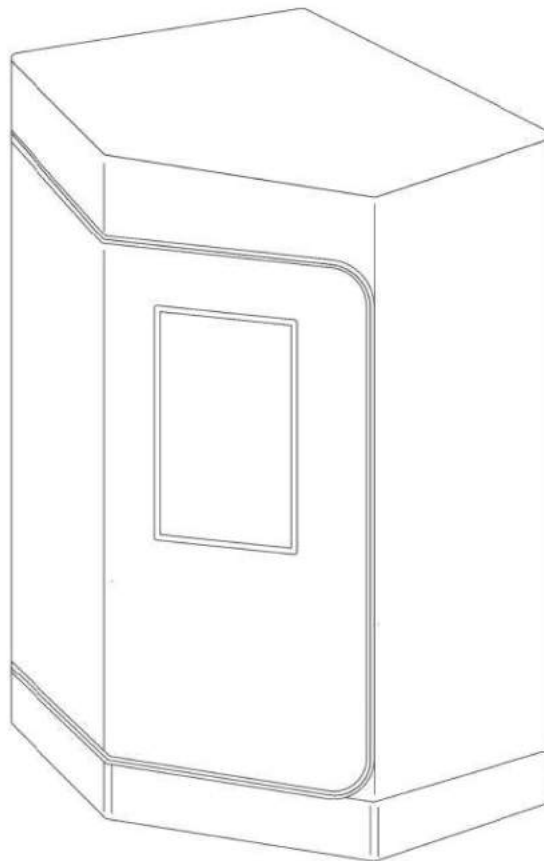

Step 1

Now that the tent is complete, it's time to connect the steam generator to the sauna. First, use the shorter semi-transparent hose and connect it to the pillbox as shown below. Once this is done, place it inside the sauna tent.

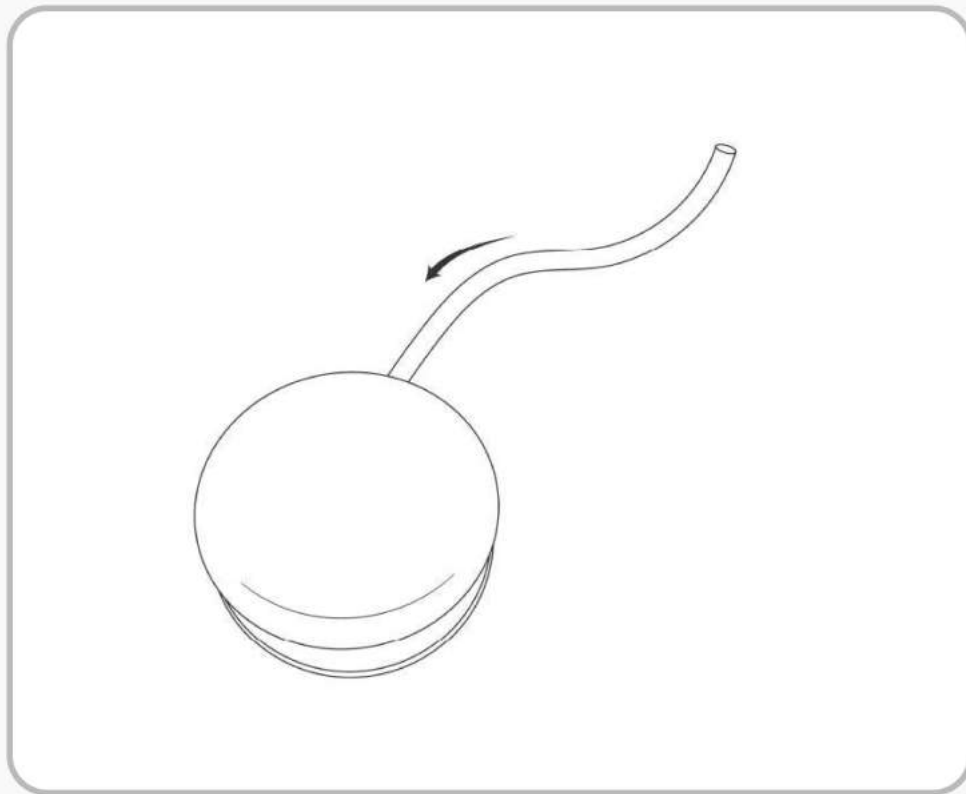

REVIVEHACK®

Phase 3

Connecting the Steam Generator

Step 2

Next, make use of the white male connectors and attach them to the other end of the hose. The hose will now go halfway through the small hole at the side of the sauna, coming through the outside of the sauna.

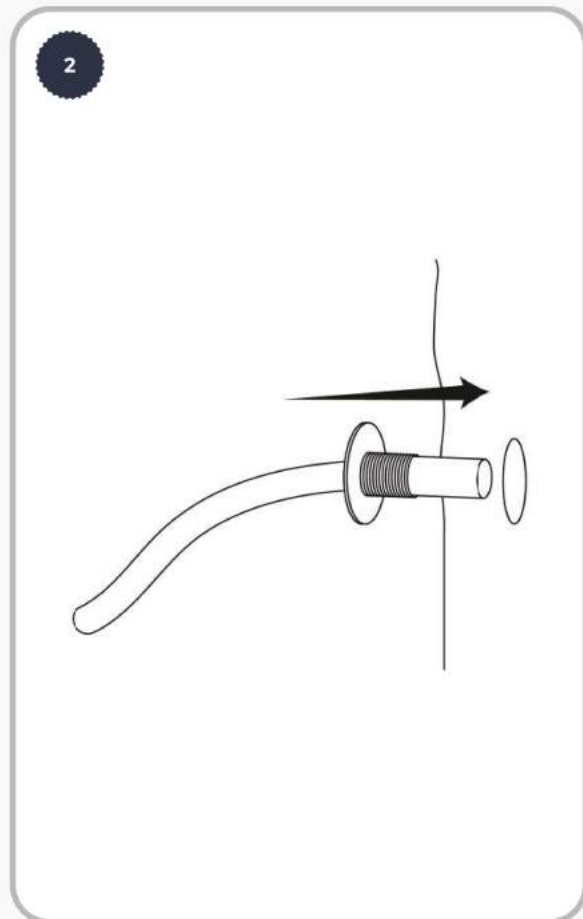
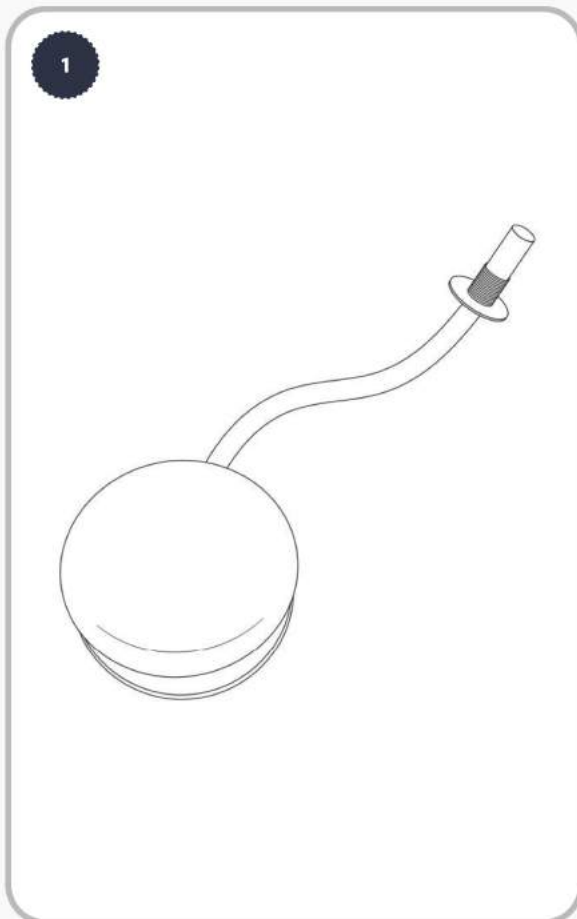

Phase 3

Connecting the Steam Generator

Step 3

Use the female connector to now screw the male connector, which is already fitted in the sauna from outside, ensuring it looks like this.

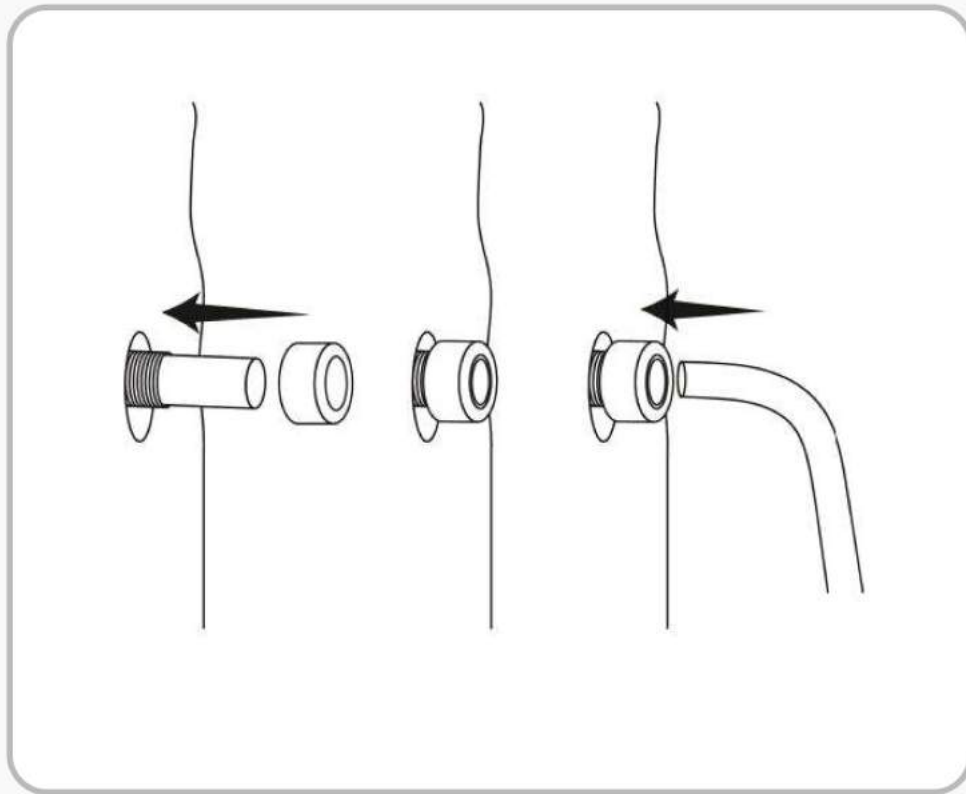

REVIVEHACK®

Phase 3

Connecting the Steam Generator

Step 4

Now connect the second longer semi-transparent hose from the male connector to the steam generator, as seen below.

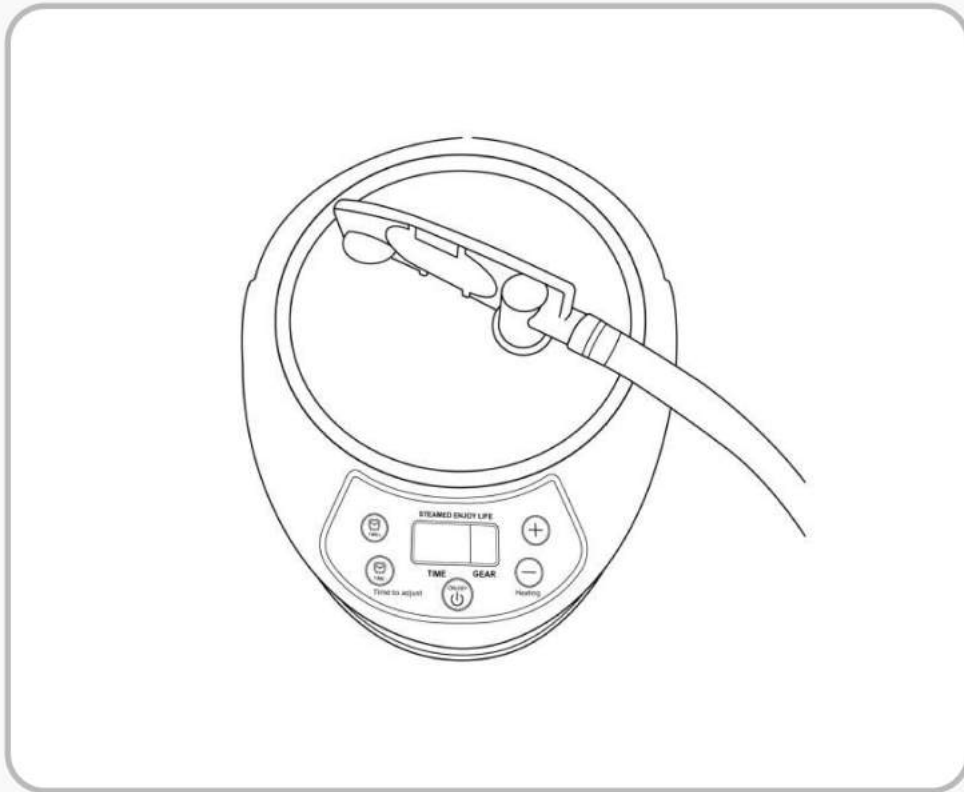

Congratulations, setup is now complete.

Using the Steam Generator

Steam Generator Instructions and Control:

- 1 Open the lid in an anti-clockwise motion

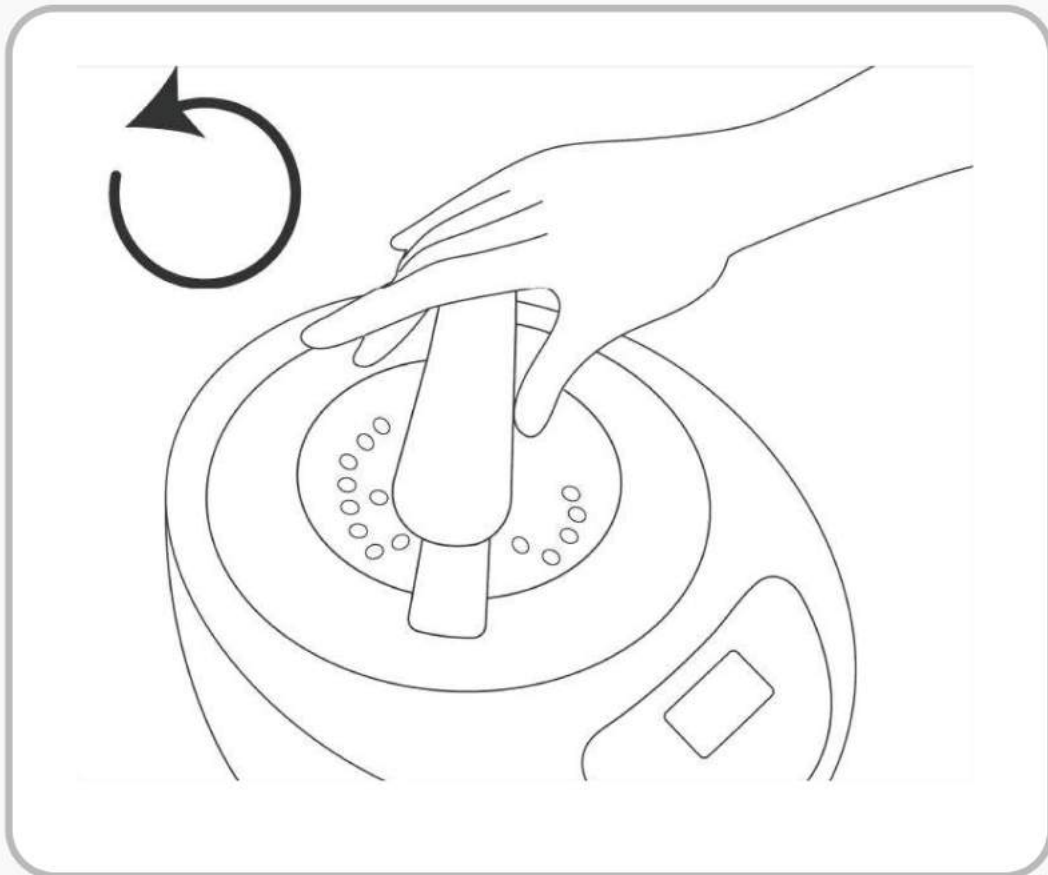

Using the Steam Generator

Fill the Generator Compartment:

- 2** Add water to the generator compartment up to the maximum water level indicator.

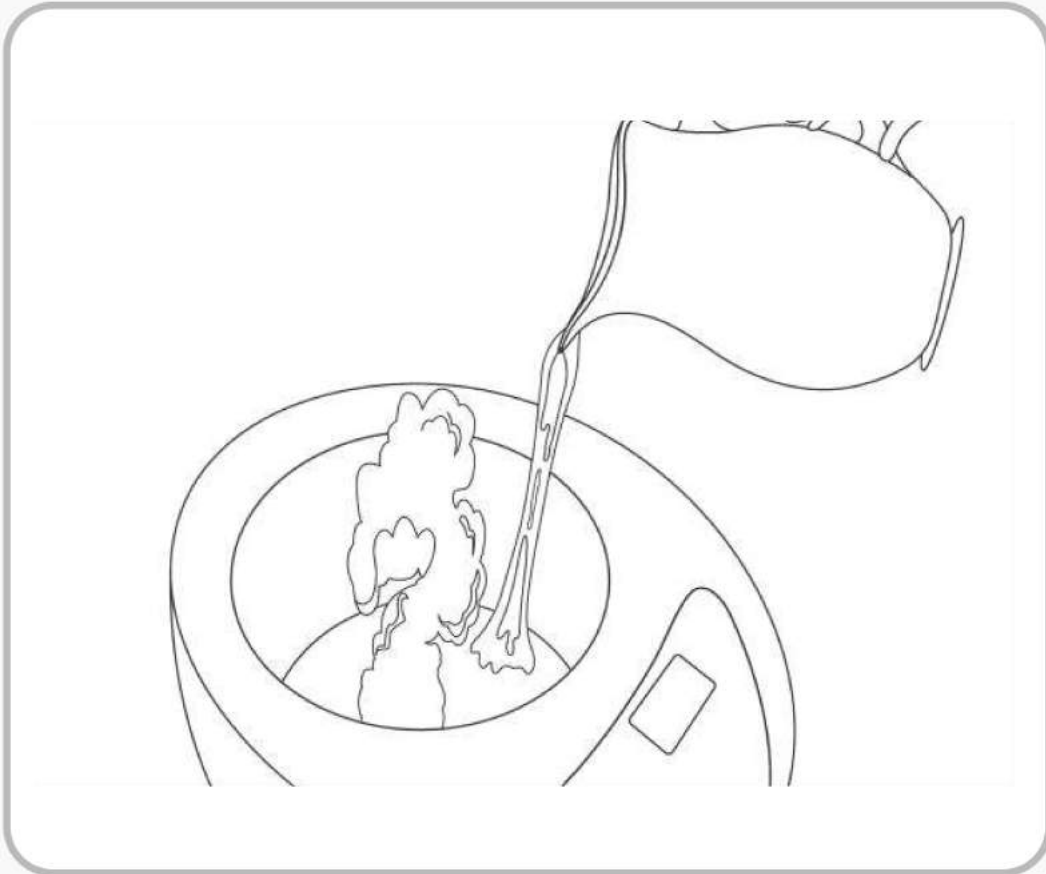

Using the Steam Generator

Secure the Lid:

- 3 Tighten the lid clockwise to prevent steam from escaping

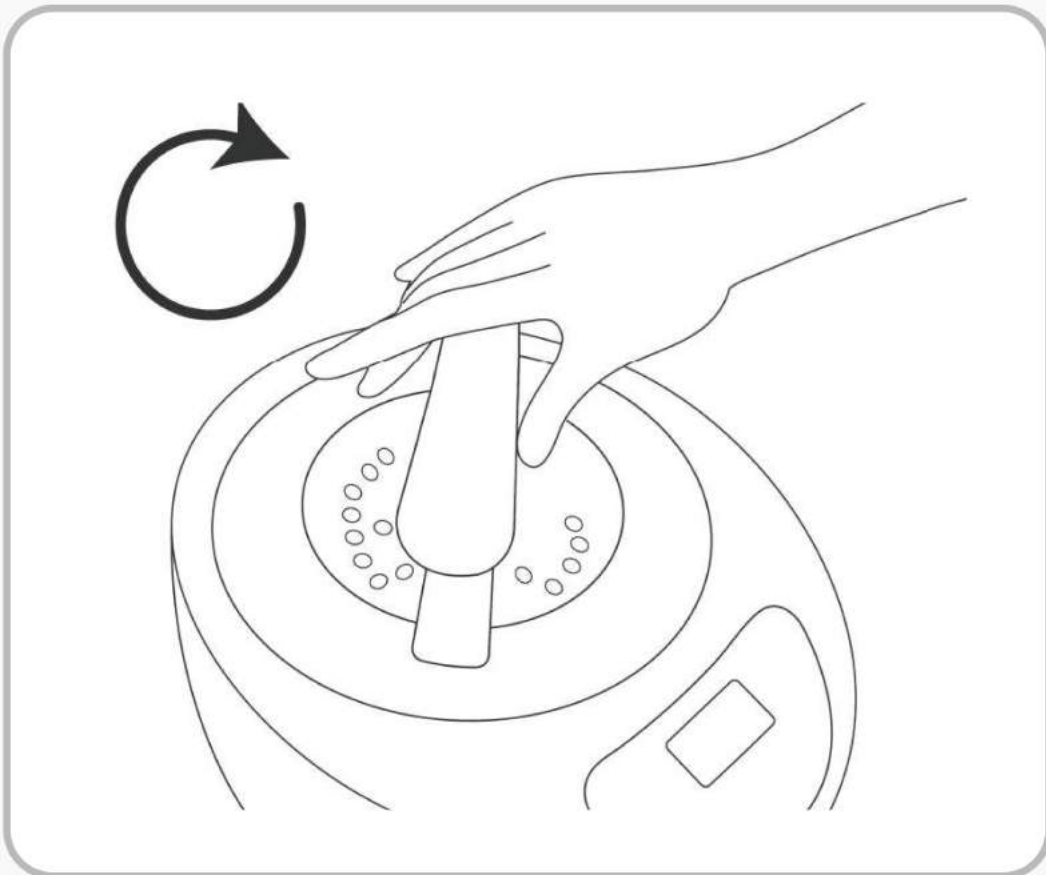

Using the Steam Generator

Power Up: ⚡

- 1** Plug the steam generator into the correct home outlet 110v, switch on the power, and press "ON/OFF."

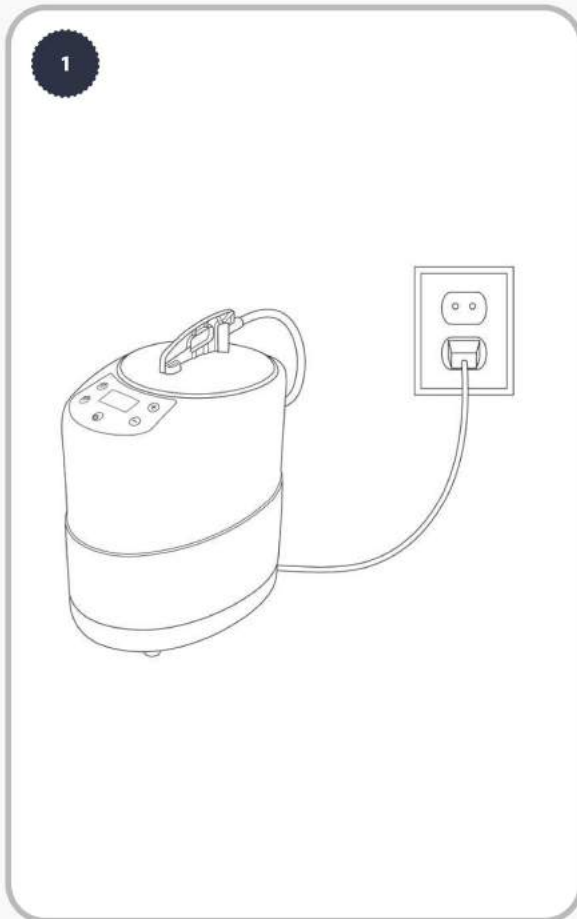

REVIVEHACK®

Using the Steam Generator

Steam Production:

- 1 Steam production begins within 10–15 minutes.

Prepare the Sauna:

- 2 Place the foldable chair inside the sauna.

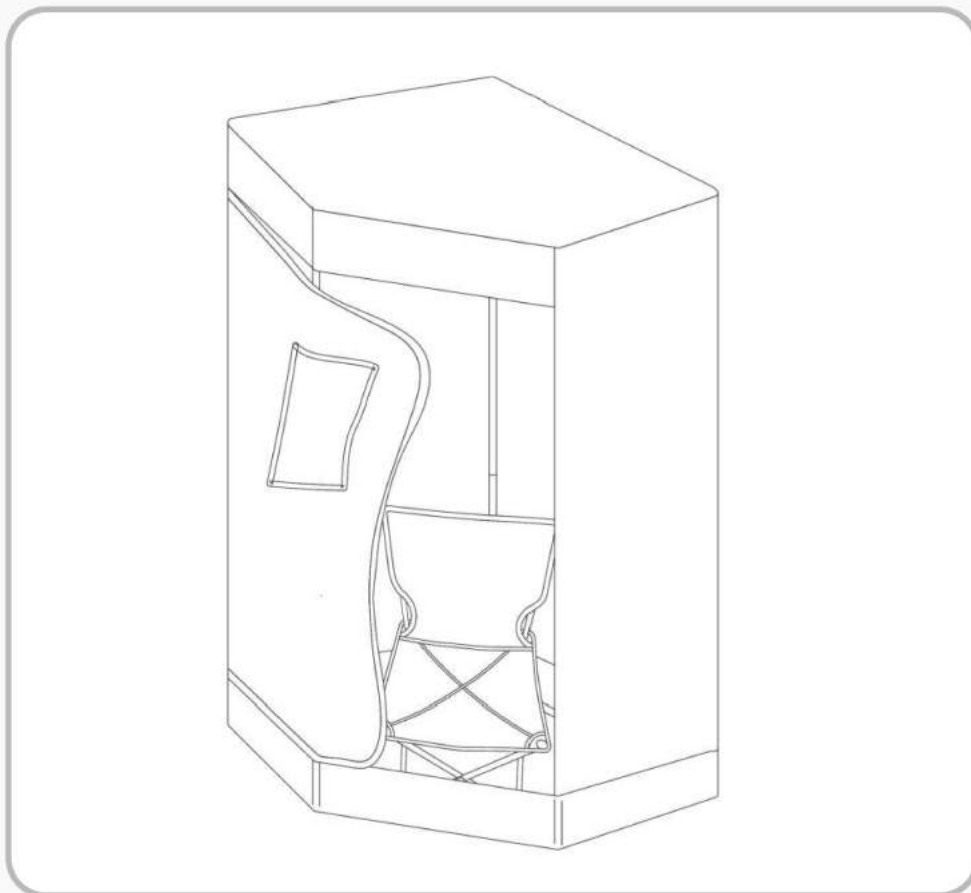

Using the Steam Generator

Adjust Time and Heating Level:

- 1 Set the desired time (0-99 mins) and heating level (1-9).

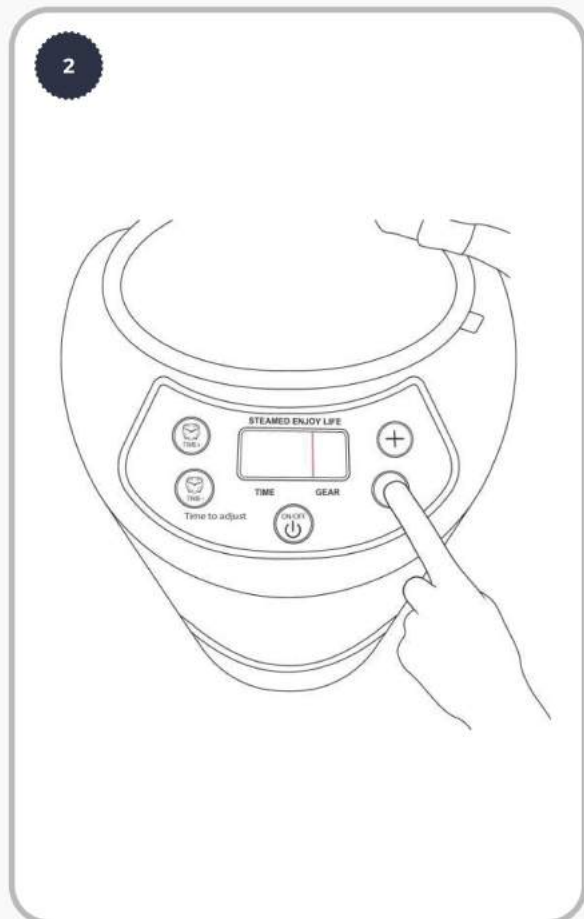
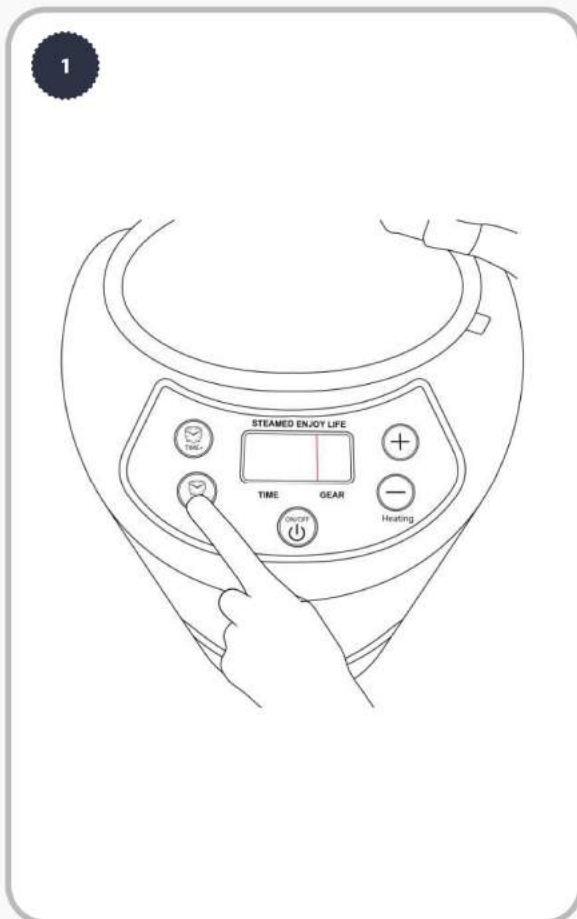

REVIVĒHACK®

Using the Steam Generator

Remote Control Setup:

- 1 If using a remote control, ensure the CR2025/2032 button battery is properly loaded.

Automatic Stop Feature:

- 2 The generator stops automatically if the water dries out. After cooling down, restart if needed.

Maintenance Tips:

- 3 Avoid adding corrosive liquids to the pot for an extended lifespan.
- 4 After use, wipe the interior with a soft towel to remove water.

Herbs Usage:

- 5 If using herbs, place them in a non-woven fabric bag. Inside white pill box.

Using the Steam Generator

Remote Control Guide:

- A Switch Button (A):** Press this button to switch between standby and operating status.
- C Timing Minus Button (C):** Shorten time.
- B Timing Plus Button (B):** Prolong time.
- D Performance Down Button (D):** Decrease performance level.
- E Performance Up Button (E):** Enhance performance level.

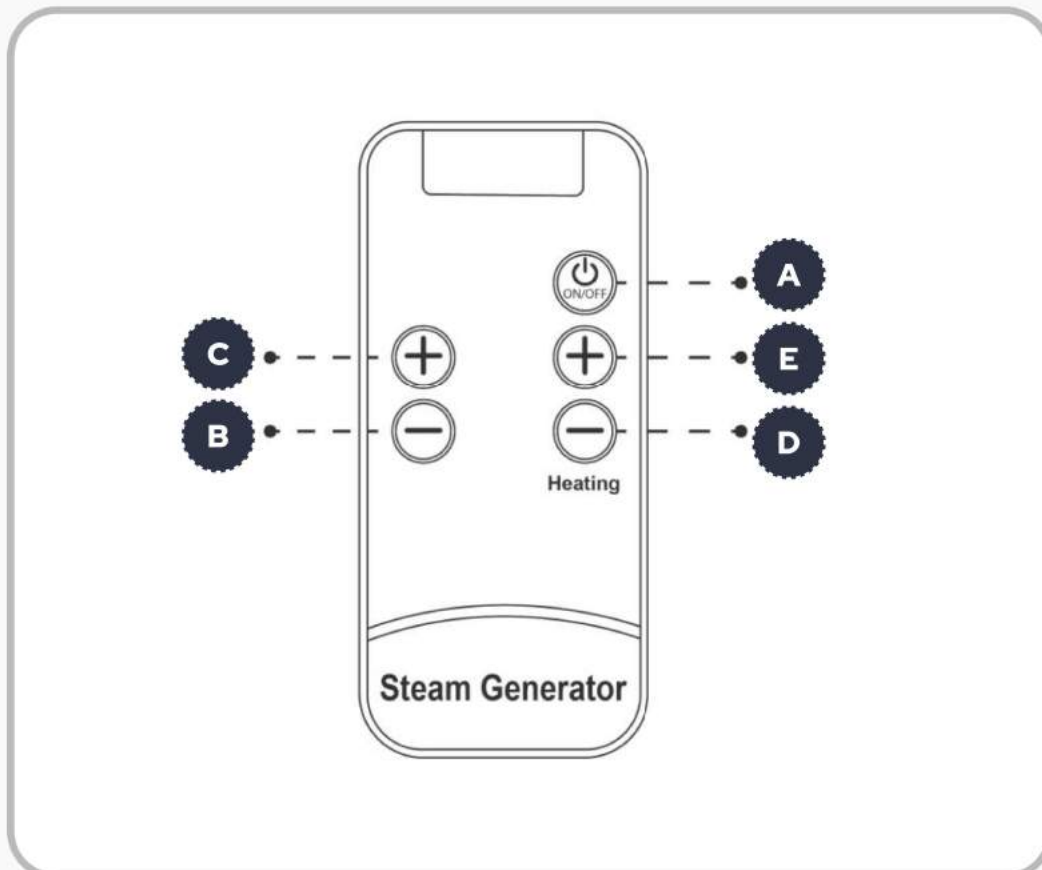

Regular use of the Sauna

It is recommended not to use the sauna for over 30 minutes per day.

How to clean Sauna

- 1 To clean and store, open the zipper to ventilate and cool.**
- 2 After each use, remove condensation or perspiration from the interior with a clean, damp cloth.**
- 3 Do not use harsh cleaning agents.**
- 4 Unplug the generator when not in use and fold for storage.**

REVIVEHACK®