

Hall Effect Base Linear Current Sensor

Features:

- Diameter 9.0mm conductor through hole
- Output voltage proportional to AC and DC current
- Wide sensing current range 0~200A at 5V volt.
- High sensitivity 11mV/A
- Wide operating voltage range 3.0~12 V.
- Low operating current 3mA
- Isolation voltage 4000V
- Ratiometric output from supply voltage
- 23K Hz Bandwidth
- Two bronze sticks for easy soldering on PCB



Functional Description:

The Winson WCS1500 current sensor provides economical and precise solution for both DC and AC current sensing in industrial, commercial and communications systems. The unique package provides easy implementation without breaking original system and makes current sensing possible. Typical applications include motor control, load detection and management, over-current fault detection and any intelligent power management system etc...

The WCS1500 consists of a precise, low-temperature drift linear hall sensor IC with temperature compensation circuit and a diameter 9.0mm through hole. Users can use system's own electric wire by pass it through this hole to measure passing current. This design allows system designers to monitor any current path without breaking or changing original system layout at all. Any current flowing through this hole will generate a magnetic field which is sensed by the integrated Hall IC and converted into a proportional voltage.

The terminals of the conductive path are electrically isolated from the sensor leads. This allows the WCS1500 current sensor to be used in applications requiring electrical isolation without the use of opto-isolators or the other costly isolation techniques and make system more competitive in cost.

Winson reserves the right to make changes to improve reliability or manufacturability.

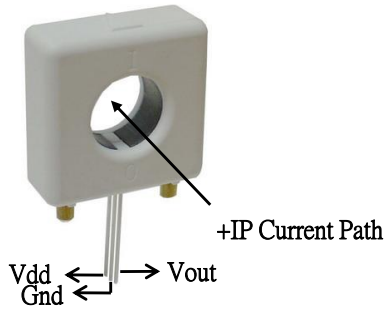

Vout vs. Primary Current

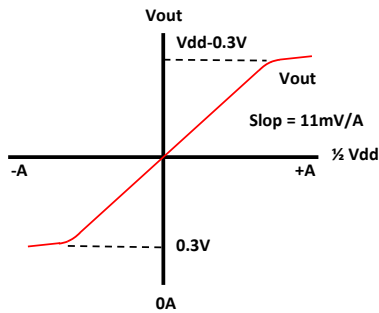

Absolute Maximum Range

Supply Voltage, Vdd -----	14V
Pass Through Wire Diameter -----	9mm
Output Current Sink-----	0.4mA
Output Current Source-----	2mA
Basic Isolation Voltage -----	4000V
Operating Temperature Range, Ta -----	-20°C to +125°C
Storage Temperature Range, Ts -----	-65°C to +150°C
Power Dissipation, Pd -----	1W

Order Information

(Vdd = 5V)

Part No.	Sensitivity	Current range
WCS1500	11 mV/A	DC: ±0 ~ 200A
		AC: rms 150A

Function Block:

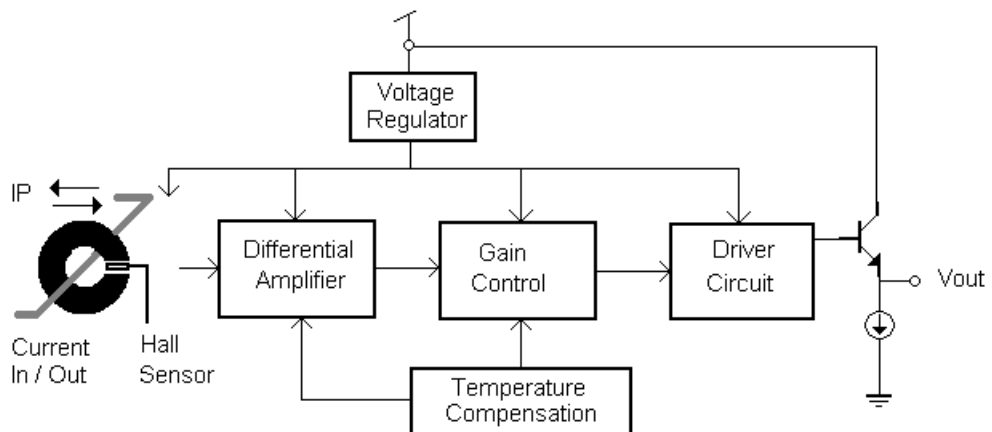

Winson reserves the right to make changes to improve reliability or manufacturability.

Electrical Characteristics: (T=+25°C, Vdd=5.0V)

Characteristic	Symbol	Test Conditions	Min	Typ	Max	Units
Supply Voltage	V _{dd}	—	3.0	—	12	V
Supply Current	I _{supply}	I _P = 0 A	—	3.5	6.0	mA
Zero Current V _{out}	V _{0G}	I _P = 0 A (DC Mode)	2.4	2.5	2.6	V
Conductor Through Hole	—	—	—	9.0	—	mm ²
Sensitivity	Sens	I _P = ±10 A	9	11	13	mV/A
Bandwidth	BW	—	—	23	—	kHz
Measurable Current Range	MR	V _{dd} =5V (DC Mode)	—	±200	—	A
		V _{dd} =5V (AC RMS)	—	150	—	
Temperature Drift	ΔV _{out}	I _p = 0 A	—	±0.2	—	mV/°C
Output Noise	V _{Np-p}	I _p = 0 A	—	2.5	—	mV
	V _{Np-p(0.01uF)}	I _p = 0 A, C = 0.01uF	—	1	—	

1. All output-voltage measurements are made with a voltmeter having an input impedance of at least 100kΩ
2. Do not apply any 'resistor load' on output pin, it will degrade IC's performance.

Characteristic Diagrams:

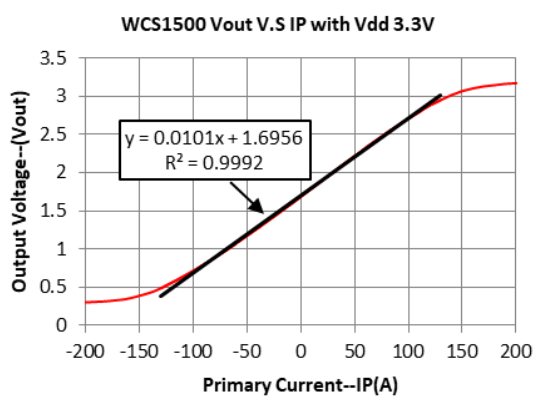
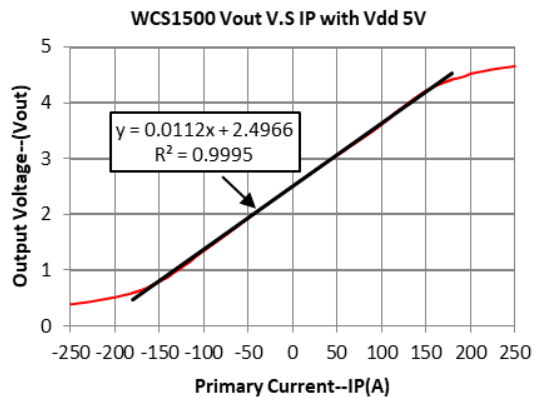
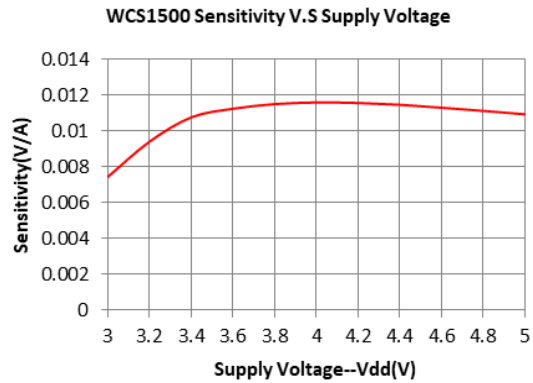
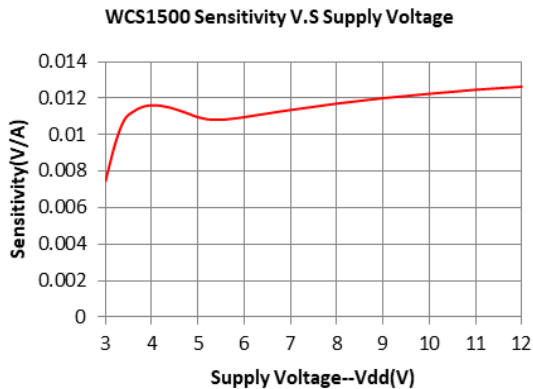

Winson reserves the right to make changes to improve reliability or manufacturability.

WCS1500 Sensitivity standardization of 30°C (5V) V.S Temperature

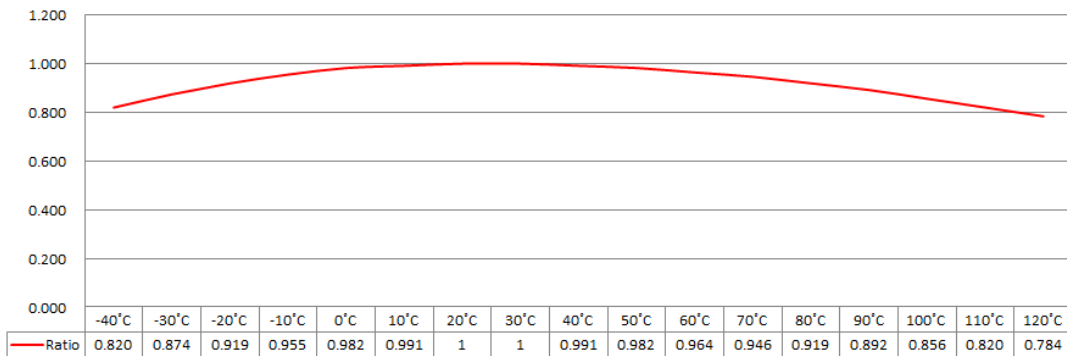

WCS1500 Sensitivity standardization of 30°C (3.3V) V.S Temperature

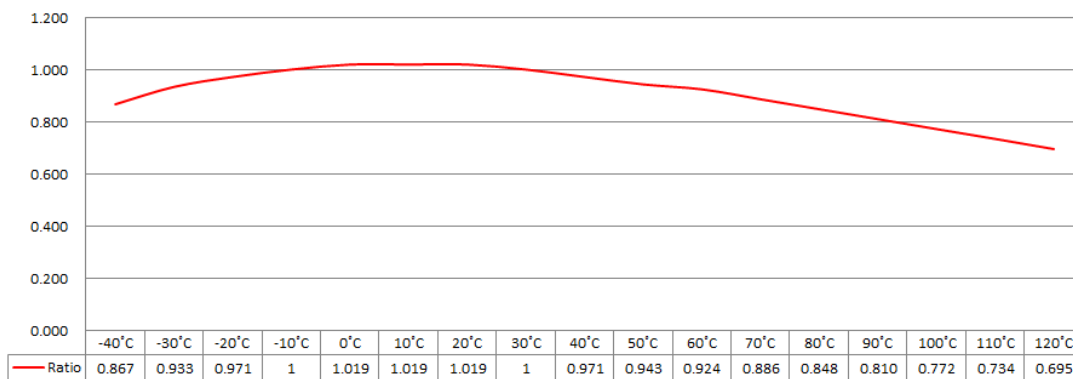

Application Circuit:

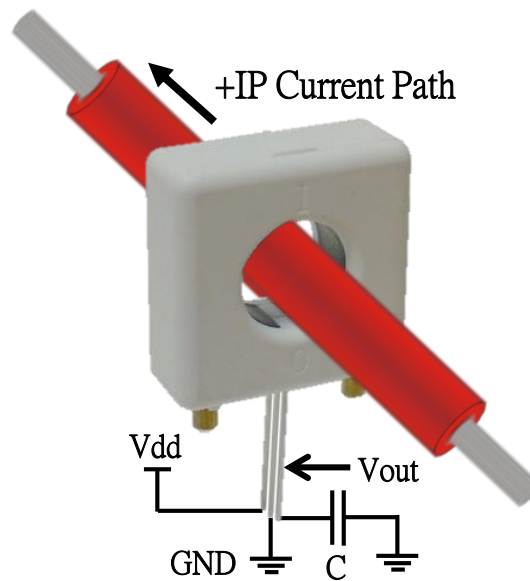

Capacitor **C**(0.01uF~0.1uF) is recommend to be connected between Vout and GND to reduce output noise.

Winson reserves the right to make changes to improve reliability or manufacturability.

Package Information:

(Unit: mm)

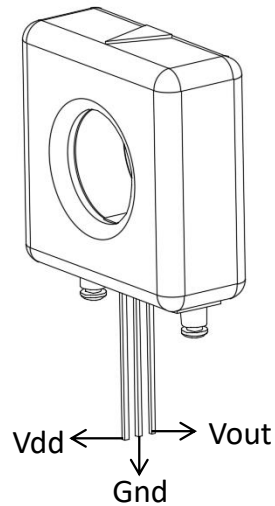
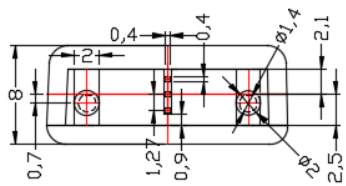
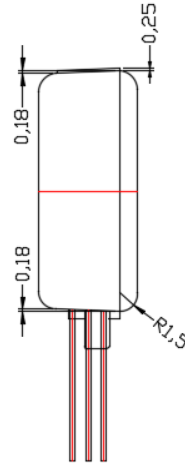
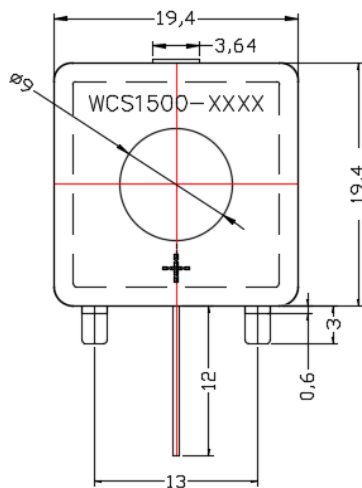

PCB Layout Reference View (Top View)

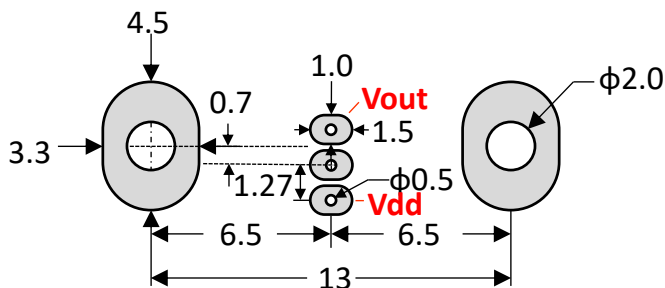

WCS Application Note : please refer to Winson Website -> Products->

Application Note -> WCS Application Note :

<http://www.winson.com.tw/Product/83>

Winson reserves the right to make changes to improve reliability or manufacturability.