

rolly® DIGGER

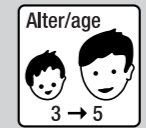

rolly toys Kundendienst Deutschland:
Tel: +49 (0) 95 68 / 856-142
Fax: +49 (0) 95 68 / 856-183
e-mail: service@rollytoys.de



2011/05

100.000.800.00

- A** M8 x 70
1x
 - B** M6 x 70
1x
 - C** M6 x 55
1x
 - D** M6 x 35
1x
 - E** M6 x 20
1x
 - F** M6 x 16
1x
 - G** ø 5 x 40
3x
 - H** M8
1x
 - I** M6
5x
 - K** ø 20 x ø 6,4 x 1,25
1x
- 0 10 20 30 40 50 60 70
(metrisch • metric) mm

---NORTH & SOUTH AMERICA only---

180 days warranty

From the date of purchase + guaranteed spare part service
The warranty does not cover damages caused by improper use or neglect

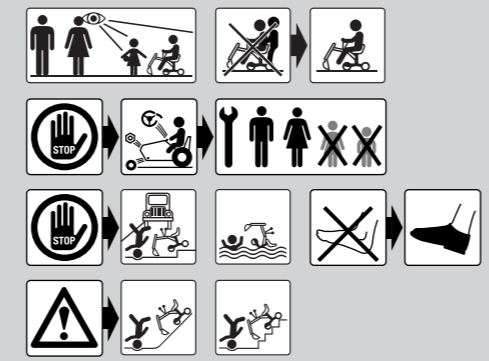

WARNING

- CHOKING HAZARD: Small parts. Danger of being swallowed. Contains small parts in non assembled state. Must be assembled by adults.
- Adult supervision required.
- Never use near steps, slopes, driveways, hills, roadways, alleys or swimming pool areas.
- Always wear shoes.
- Never allow more than one rider.
- The use of protective gear and a safety helmet is highly recommended.
- Conforms to the requirements of ASTM Standard Consumer Safety Specification on Toy Safety, F 963
- Not suitable for children under 3 years.

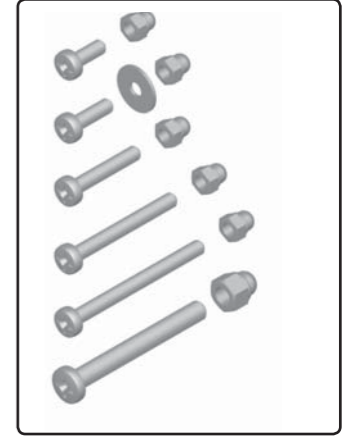
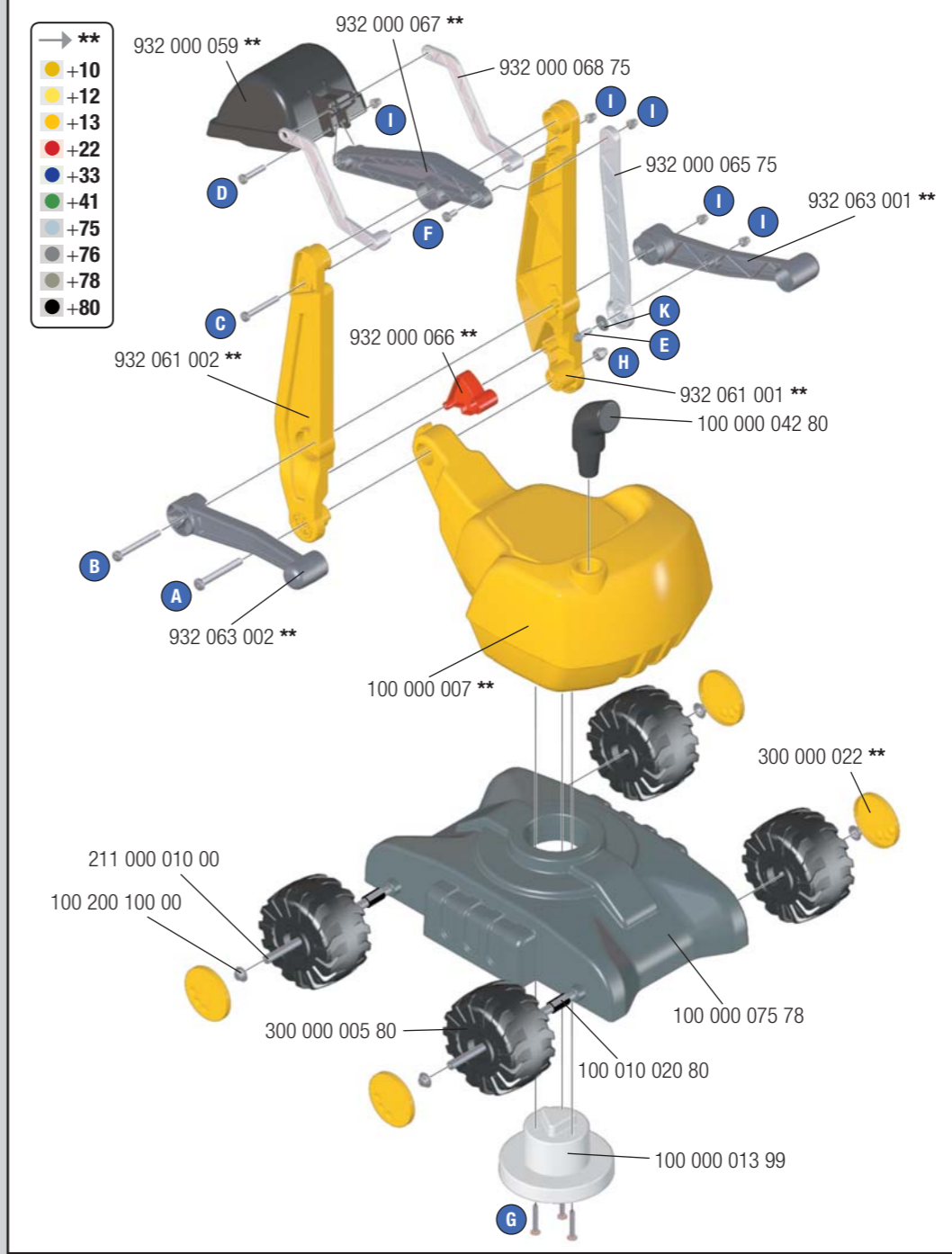

made in Germany

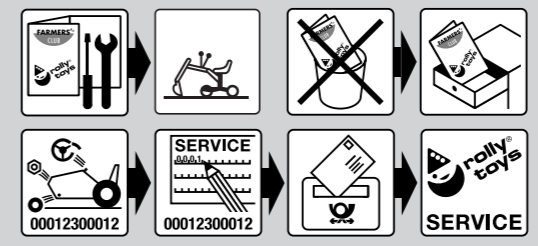

Franz Schneider GmbH & Co KG
P.O.Box 1460
D-96459 - Neustadt bei Coburg · Germany
Tel.: +49 (0) 95 68 / 856-0
Fax.: +49 (0) 95 68 / 856-190
www.rollytoys.com

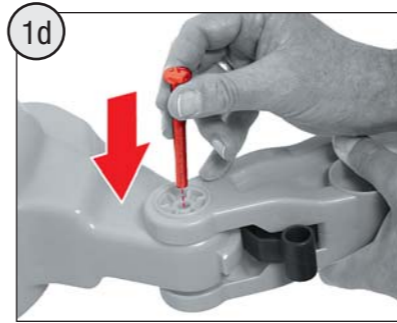
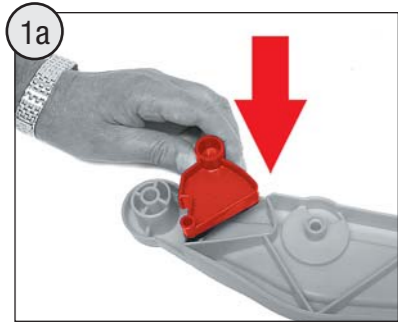

2x **A** M8 x 70

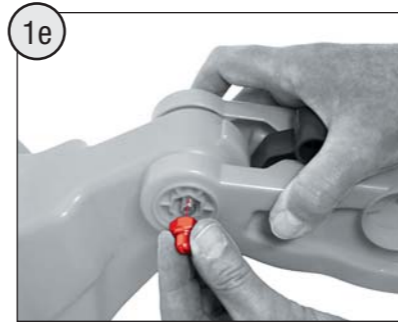

2x **H** M8

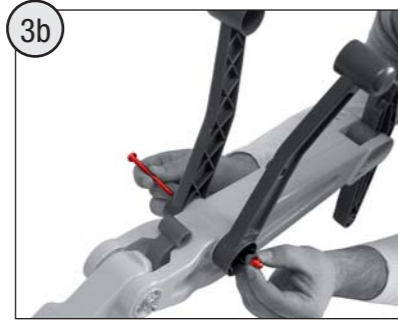
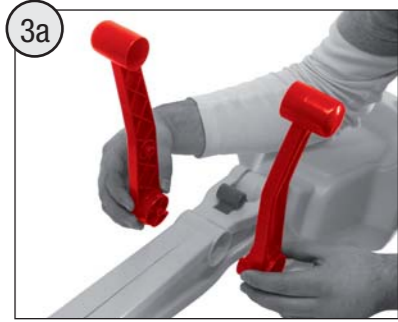
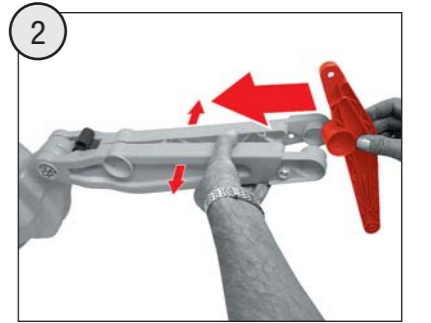
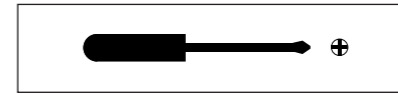
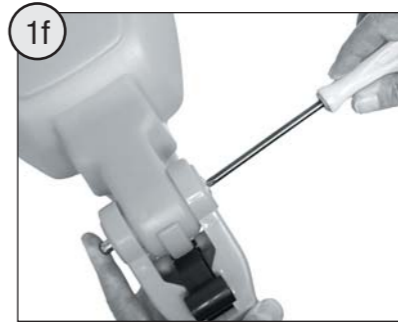

1x **B** M6 x 70 **I** M6

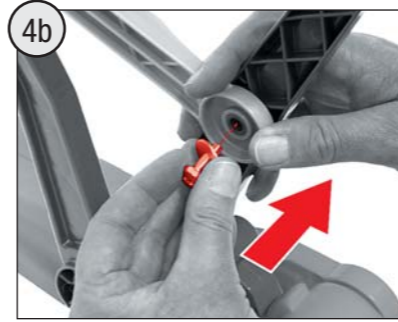
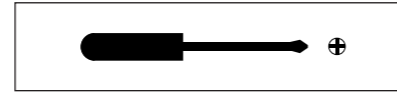
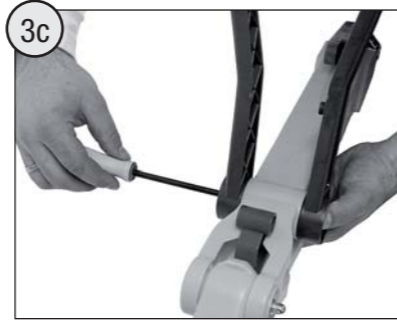

1x **E** M6 x 20 **K** ø 20

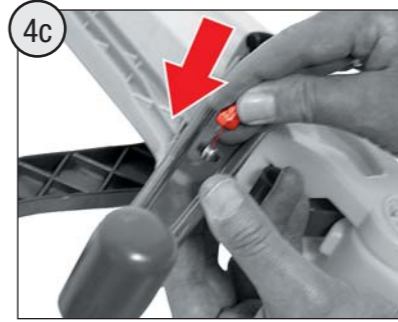

1x **I** M6

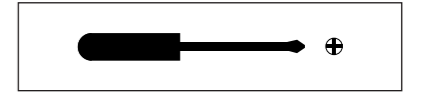
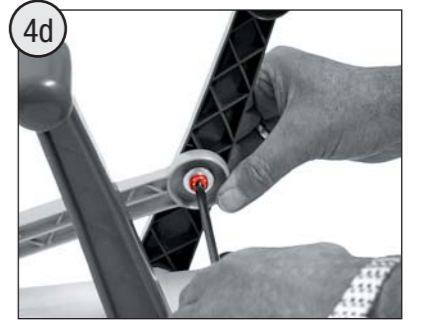

1x **F** M6 x 16 **I** M6

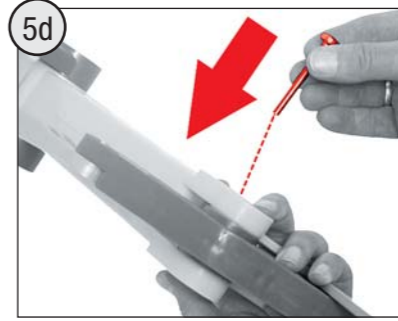
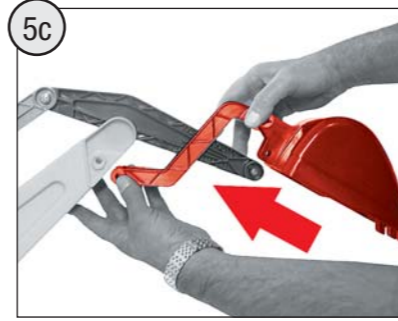
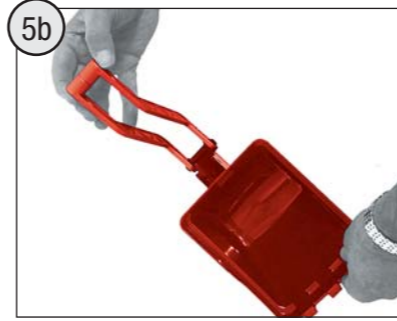
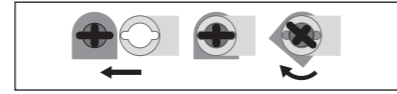
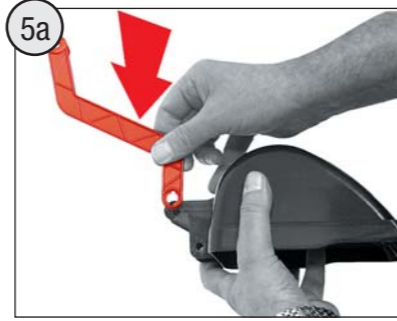
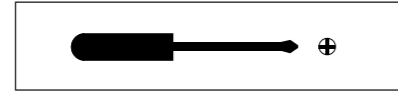
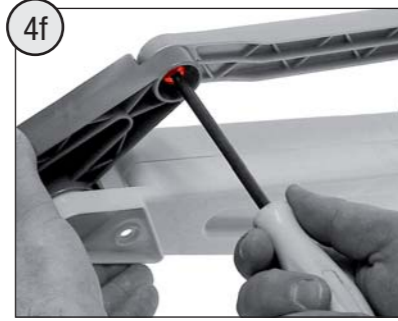

1x **C** M6 x 55

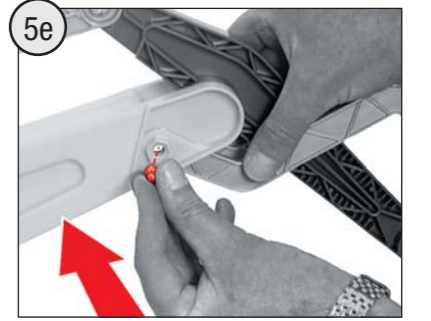

1x **I** M6

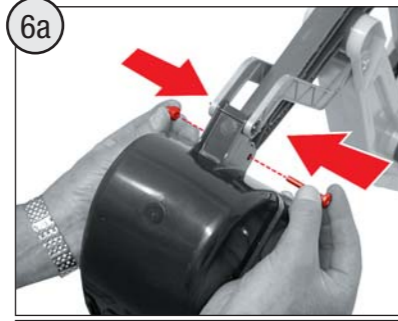
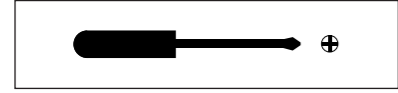
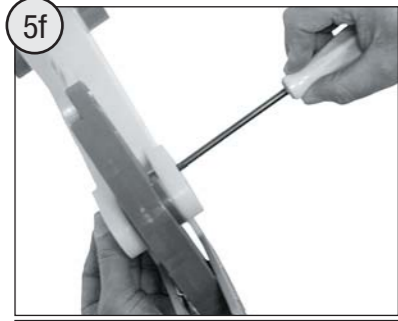

1x **D** M6 x 35 **I** M6

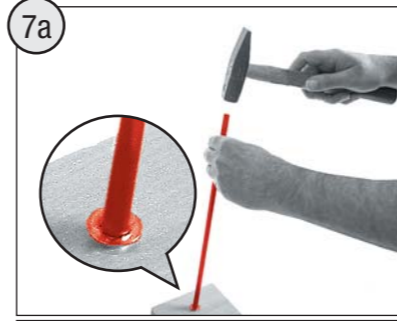
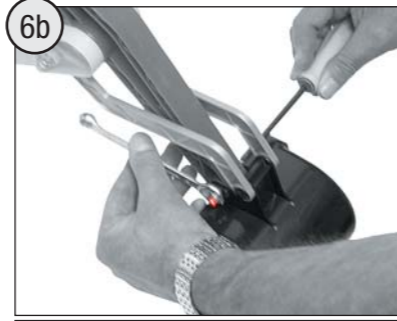

2x **ø 10 x 450**

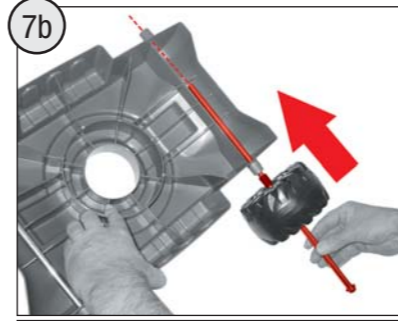

2x **ø 15 x 20**

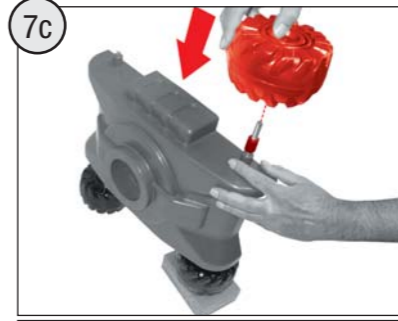

2x **ø 15 x 20**

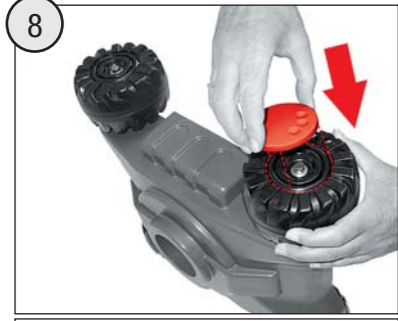
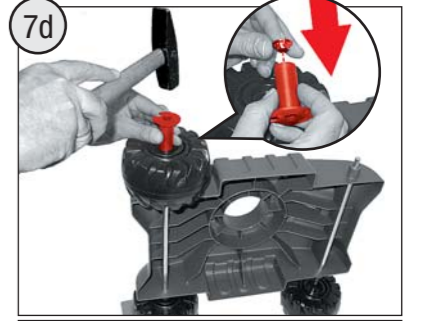

4x

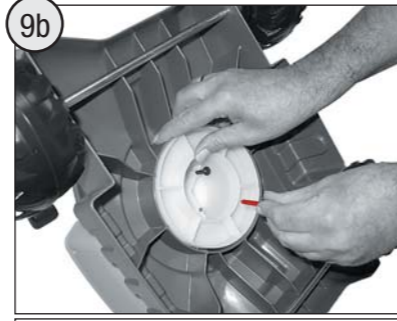

3x **G** **ø 5 x 40**

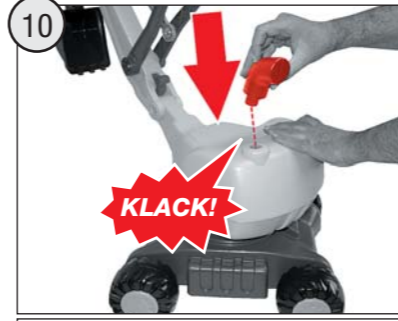
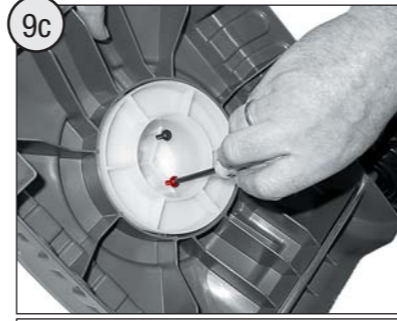

1x