

# rollyTrac

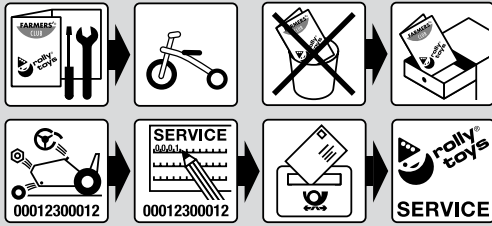
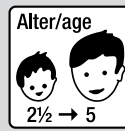

**rolly toys Kundendienst Deutschland:**

Tel: +49 (0) 95 68 / 856-142

Fax: +49 (0) 95 68 / 856-183

e-mail: service@rollytoys.de

2022/09

**261.000.800.00**



**made in Germany**

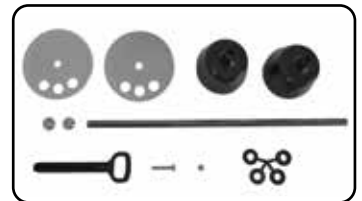

215 x 80

→ **		
● +10	● +26	● +47
● +12	● +30	● +51
● +13	● +37	● +54
● +20	● +38	● +60
● +22	● +40	● +70
● +23	● +41	● +75
● +25	● +44	● +80

## **AVERTISSEMENT**

- RISQUE D'ÉTOUFFEMENT - Petites pièces. Risque d'ingestion. Contient des petites pièces à l'état non assemblé.
- Doit être assemblé par un adulte.
- Surveillance d'un adulte est requise.
- Si le jouet est défectueux, cessez de l'utiliser.
- Toute réparation ne doit être effectuée que par un adulte.
- Ne jamais utiliser à proximité des marches, des pentes, des allées, des collines, des routes, des allées ou des piscines.
- Portez toujours des chaussures.
- Ne permettez jamais la présence de plus d'un coureur.
- L'utilisation d'un équipement de protection et d'un casque de sécurité est fortement recommandée.
- Les autocollants ne doivent être appliqués que par des adultes.
- Conforme aux exigences de la norme internationale ASTM Standard Consumer Safety Specification on Toy Safety, F 963.

## **WARNING**

- CHOKING HAZARD - Small parts, Danger of being swallowed. Contains small parts in non assembled state.
- Must be assembled by adults.
- If toy is defective stop using it, repairs may only be carried out by adults.
- Adult supervision required.
- Never use near steps, slopes, driveways, hills, roadways, alleys or swimming pool areas.
- Always wear shoes.
- Never allow more than one rider.
- The use of protective gear and safety helmet is highly recommended.
- The stickers are to be applied by adults only.
- Conforms to the requirements of ASTM Standard Consumer Safety Specification on Toy Safety, F 963.



**Franz Schneider GmbH & Co KG**

Siemensstrasse 13-19

D-96465 · Neustadt bei Coburg · Germany

Tel.: +49 (0) 95 68 / 856-0

Fax.: +49 (0) 95 68 / 856-190

www.rollytoys.com

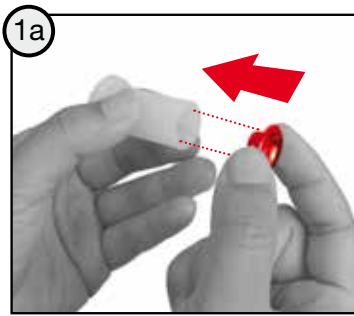

1x 1x

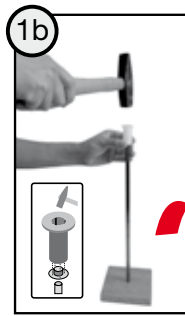

1x  $\varnothing 10 \text{ mm} \times 375$

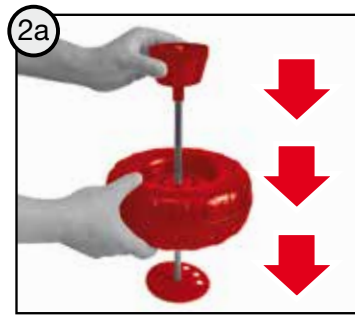

1x 1x 1x

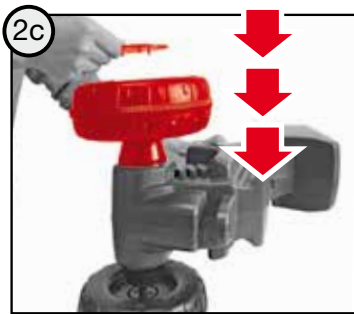
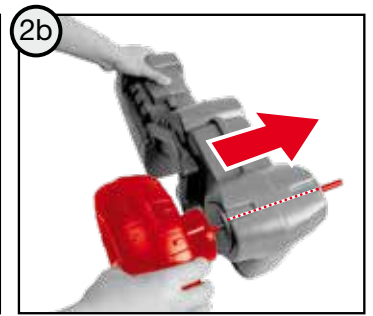

1x 1x 1x

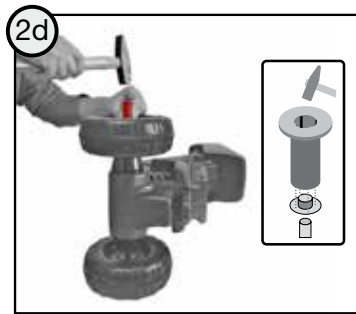

1x 1x

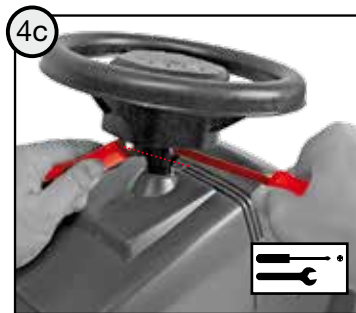
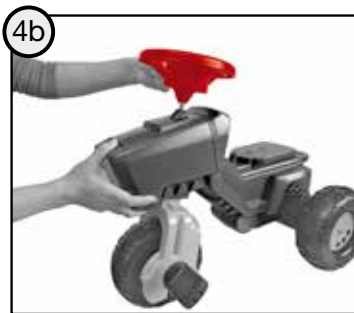
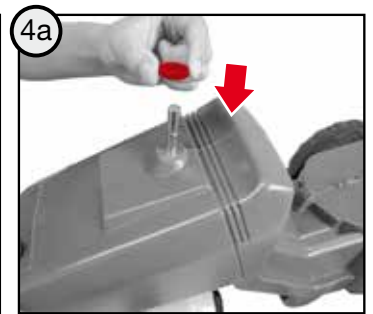
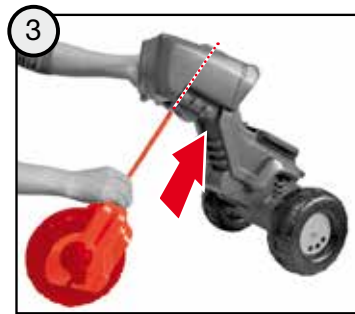

1x M5 x 30 1x M5

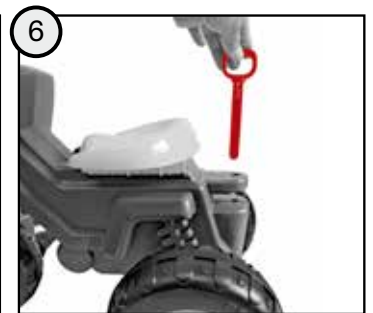
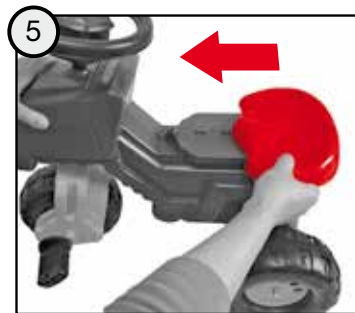

**A** M5 x 30  
1x

**B** M5  
1x

0 10 20 30 40 50 mm  
(metrisch • metric)



--- NORTH & SOUTH AMERICA only ---

**180 days** warranty

From the date of purchase + guaranteed spare part service

The warranty does not cover damages caused by improper use or neglect

# rollyKid Trailer

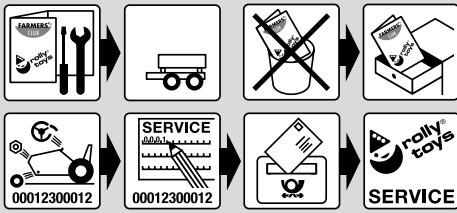
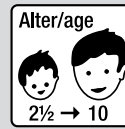

rolly toys Kundendienst Deutschland:

Tel: +49 (0) 95 68 / 856-142

Fax: +49 (0) 95 68 / 856-183

e-mail: service@rollytoys.de

2022/03

211.000.800.00

- \*\*
- +10
- +12
- +13
- +20
- +22
- +30
- +37
- +40
- +41
- +44
- +51
- +70
- +75



made in Germany

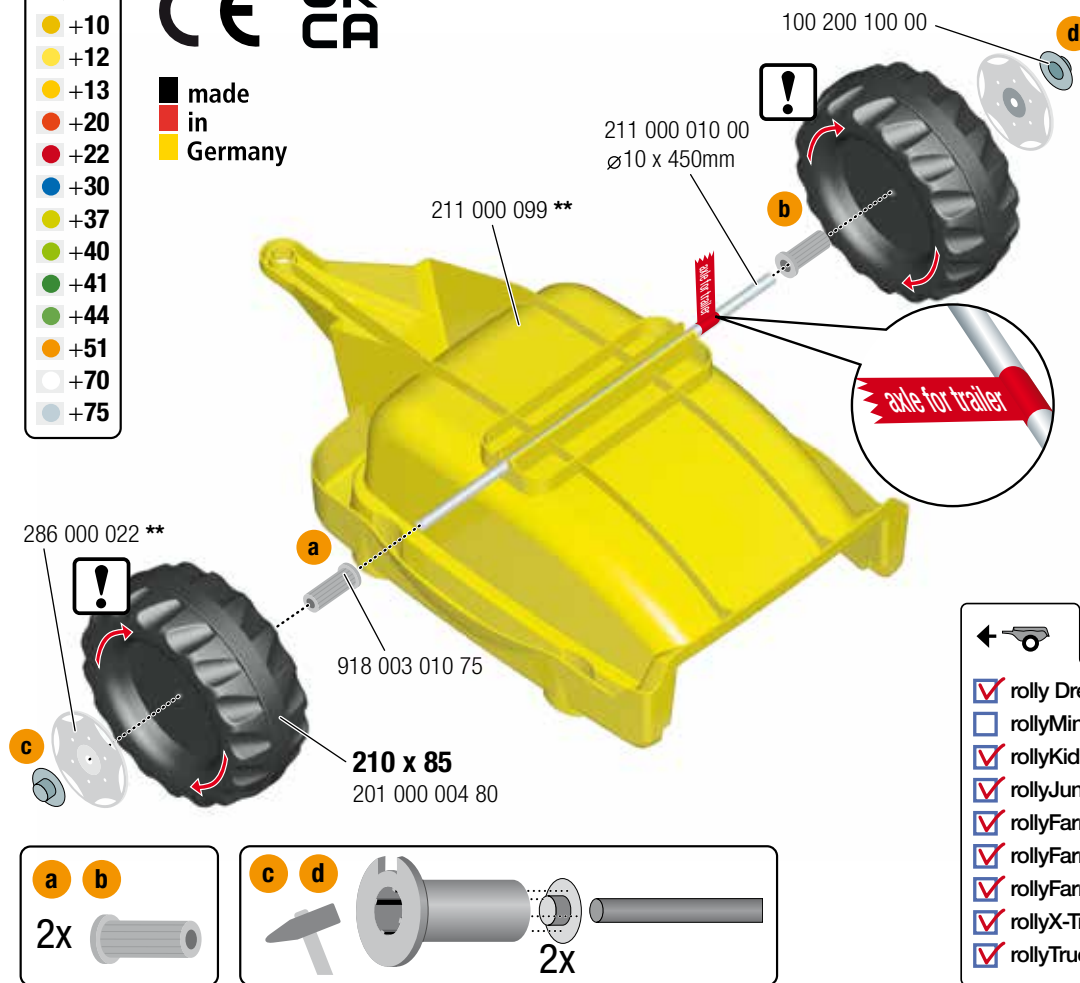

<input checked="" type="checkbox"/>	rolly Dreiradtraktoren	05 ● ● ●
<input type="checkbox"/>	rollyMinitrac	13 ● ● ●
<input checked="" type="checkbox"/>	rollyKid	01 ● ● ● / 02 ● ● ●
<input checked="" type="checkbox"/>	rollyJunior	80 ● ● ● / 81 ● ● ●
<input checked="" type="checkbox"/>	rollyFarmtrac	60 ● ● ● / 61 ● ● ●
<input checked="" type="checkbox"/>	rollyFarmtrac Classic	03 ● ● ● / 04 ● ● ●
<input checked="" type="checkbox"/>	rollyFarmtrac Premium	70 ● ● ● / 71 ● ● ●
<input checked="" type="checkbox"/>	rollyX-Trac	03 ● ● ● / 04 ● ● ●
<input checked="" type="checkbox"/>	rollyTruck (Unimog)	03 ● ● ●

## AVERTISSEMENT

- RISQUE D'ÉTOUFFEMENT - Petites pièces. Risque d'ingestion. Contient des petites pièces à l'état non assemblé. Doit être assemblé par un adulte.
- Le jouet ne convient pas au transport des enfants.
- Si le jouet est défectueux, cessez de l'utiliser. Toute réparation ne doit être effectuée que par un adulte.
- Surveillance d'un adulte est requise.
- Ne jamais utiliser à proximité des marches, des pentes, des allées, des collines, des routes, des allées ou des piscines.
- Portez toujours des chaussures.
- Les autocollants ne doivent être appliqués que par des adultes.
- Conforme aux exigences de la norme internationale ASTM Standard Consumer Safety Specification on Toy Safety, F 963.

## WARNING

- CHOKING HAZARD - Small parts, Danger of being swallowed. Contains small parts in non assembled state. Must be assembled by adults.
- Toy is not suitable to carry children.
- If toy is defective stop using it, repairs may only be carried out by adults.
- Adult supervision required.
- Never use near steps, slopes, driveways, hills, roadways, alleys or swimming pool areas.
- Always wear shoes.
- The stickers are to be applied by adults only.
- Conforms to the requirements of ASTM Standard Consumer Safety Specification on Toy Safety, F 963.

---NORTH & SOUTH AMERICA only---

**180 days warranty**

From the date of purchase + guaranteed spare part service

The warranty does not cover damages caused by improper use or neglect



Franz Schneider GmbH & Co KG

Siemensstrasse 13-19

D-96465 · Neustadt bei Coburg · Germany

Tel.: +49 (0) 95 68 / 856-0

Fax.: +49 (0) 95 68 / 856-190

www.rollytoys.com

# Soundlenkrad

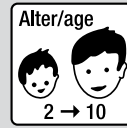

rolly toys Kundendienst Deutschland:

Tel: +49 (0) 95 68 / 856-142

Fax: +49 (0) 95 68 / 856-183

e-mail: service@rollytoys.de

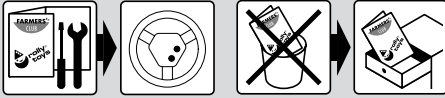

2022/09

920.000.800.00

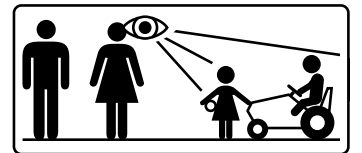
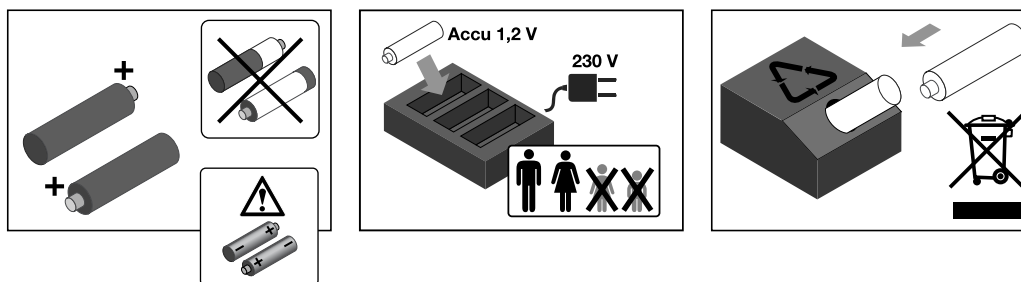
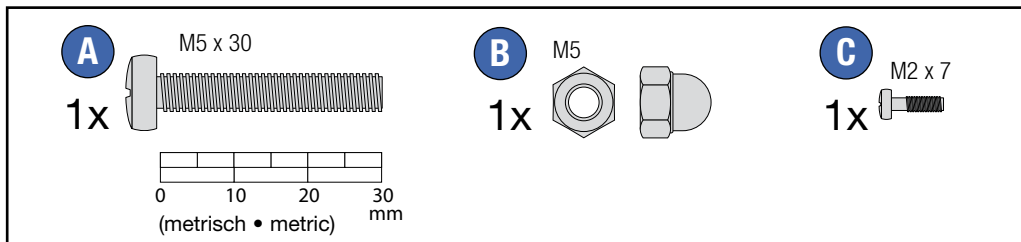
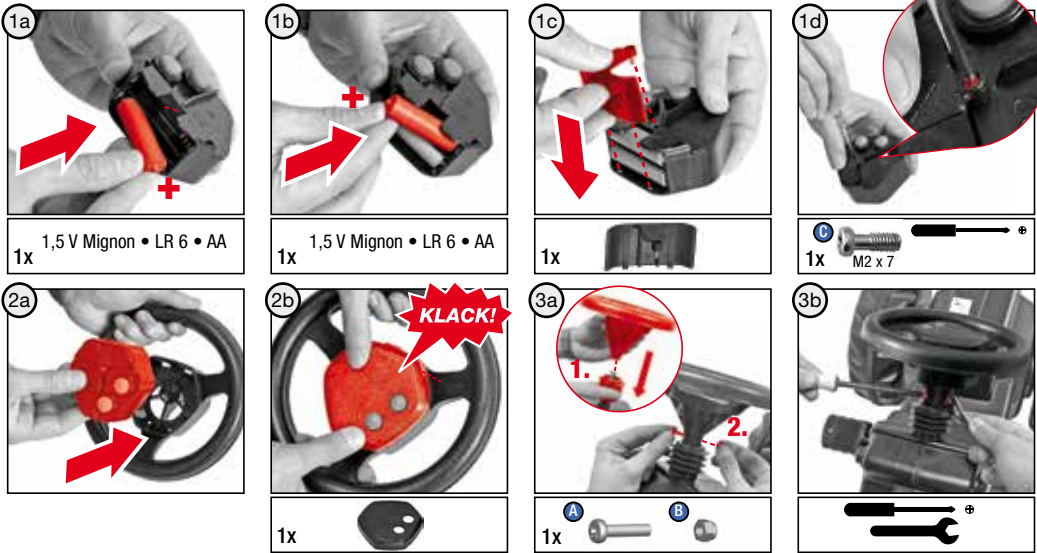

**CAUTION ELECTRIC TOY!**

---NORTH & SOUTH AMERICA only---

**180 days warranty**

From the date of purchase + guaranteed spare part service

The warranty does not cover damages caused by improper use or neglect

## ! WARNING

- CHOKING HAZARD - Small parts, Danger of being swallowed. Contains small parts in non assembled state. Must be assembled by adults.
- If toy is defective stop using it, repairs may only be carried out by adults.
- Adult supervision required.
- The stickers are to be applied by adults only.
- Conforms to the requirements of ASTM Standard Consumer Safety Specification on Toy Safety, F 963.

**Achtung! Beiblatt enthält wichtige Information!**  
**Attention! Extrasheet contains important information!**

## ! AVERTISSEMENT

- RISQUE D'ÉTOUFFEMENT - Petites pièces. Risque d'ingestion. Contient des petites pièces à l'état non assemblé. Doit être assemblé par un adulte.
- Si le jouet est défectueux, cessez de l'utiliser. Toute réparation ne doit être effectuée que par un adulte.
- Surveillance d'un adulte est requise.
- Les autocollants ne doivent être appliqués que par des adultes.
- Conforme aux exigences de la norme internationale ASTM Standard Consumer Safety Specification on Toy Safety, F 963.



made in Germany



**Franz Schneider GmbH & Co KG**

Siemensstrasse 13-19

D-96465 · Neustadt bei Coburg · Germany

Tel.: +49 (0) 95 68 / 856-0

Fax.: +49 (0) 95 68 / 856-190

www.rollytoys.de