



BERG USA TRAMPOLINES

Productsheet



BERG Champion trampolines
BERG Grand Champion trampolines
BERG Ultim Champion trampolines

*Long, safe jumping
in every garden!*

BERGTOYS.COM



WHY A BERG TRAMPOLINE?

Choose the unbeaten Champion

BERG Trampolines have been developed with great attention and care. This resulted in qualitative excellent trampolines, which are safe to use. It does not matter which one you choose, you choose quality with a BERG Trampoline. BERG Trampolines are cleverly designed for long and safe jumping. The combination of the TwinSpring Gold springs and the AirFlow jumping technique ensures less air resistance, a larger jump area and more jumping fun!

BERG Trampolines are available in different sizes. They are available as Regular, InGround and FlatGround trampoline.

In this productsheet you can find information about:

1. Various shapes
2. PVC protective edge
3. AirFlow jumping mat
4. TwinSpring Gold
5. Round Frame
6. Grand Frame
7. Ultim Frame
8. Safety Net Deluxe
9. Safety Net Deluxe XL
10. AeroWall BLK&GRY

WARRANTY

Frames: 10 (13*) years

Protective edge: 2 years

Jumping mat: 2 years

Springs: 5 years

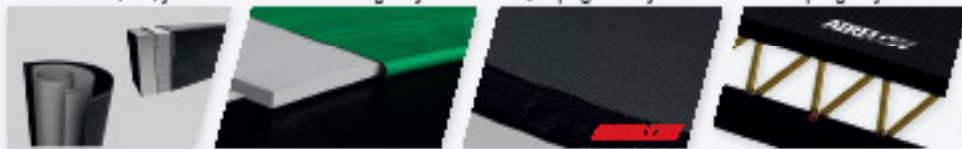

* After registration at bergtoys.com/registreren

In this productsheet Model, size and colour subject to change. Printing and typesetting errors reserved.





1. VARIOUS SHAPES

The frame of a round trampoline is very strong. On a round trampoline you always jump towards the center. The best jumps are made in the center of a round trampoline. This is because the tension on the springs and the frame is equally divided when jumping.



The oval shape combines the efficient strength of a round frame with the large jumping surface of a rectangular trampoline. On an oval trampoline you can make some nice jumps over the entire length.



On a rectangular trampoline you can jump over the entire length. The jumps that you make on a rectangular trampoline are more controlled. That's why rectangular trampolines are used by top performers at the Olympic Games.

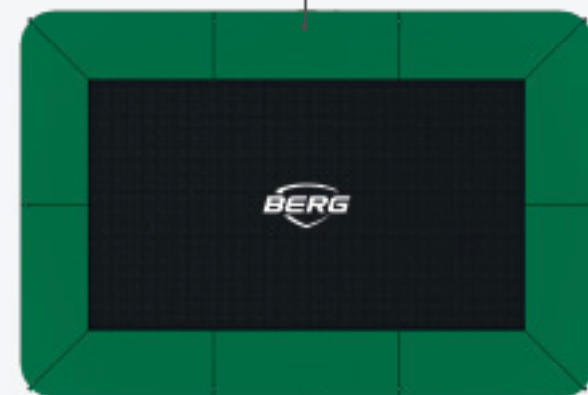



2. PVC PROTECTIVE EDGE

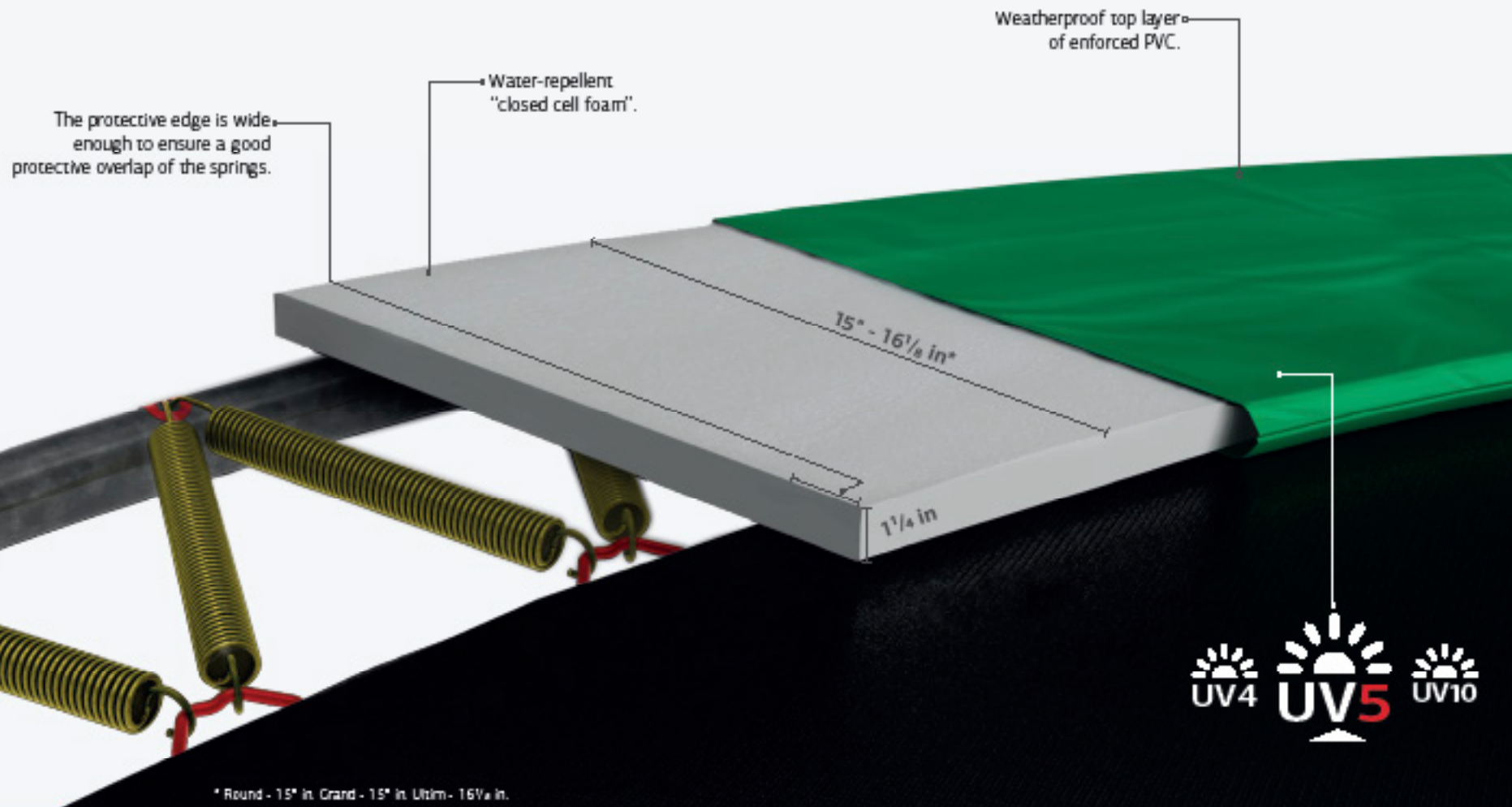



3. AIRFLOW JUMPING MAT

Higher jumps mean more fun. We have developed the AirFlow technique to enable you to make higher jumps. This jumping mat allows 50% more air permeation compared with a standard jumping mat. Good airflow ensures less resistance while jumping, which is why you can make higher jumps.

The AirFlow jump mat is made from durable and woven polypropylene. The jump mat contains special spring-eyes for the TwinSpring system. The loops for the strong metal spring eyes are toughly joined to the jump mat with no less than 8 rows of stitching.



POWERED BY
AIRFLOW
& TWINSRING

The AirFlow product innovation is only available on the BERG Champion and BERG Elite lines.





4. TWINSRING GOLD

The perfect jump area is that optimal part of the jumping mat which results in the best jumping experience. Jumping outside of this area results in a sense of feeling as if you are being pushed towards the inner part of the trampoline. Trampolines comprising of TwinSpring Gold Springs are mounted in the shape of a "V". This allows for larger perfect jump area compared to trampolines that are sold with a conventional spring.

Another advantage? Due to the angled positioning of the TwinSpring Gold, the springs are longer in length without compromising the size of the jump mat. This results in a safer trampoline that optimizes playing pleasure!

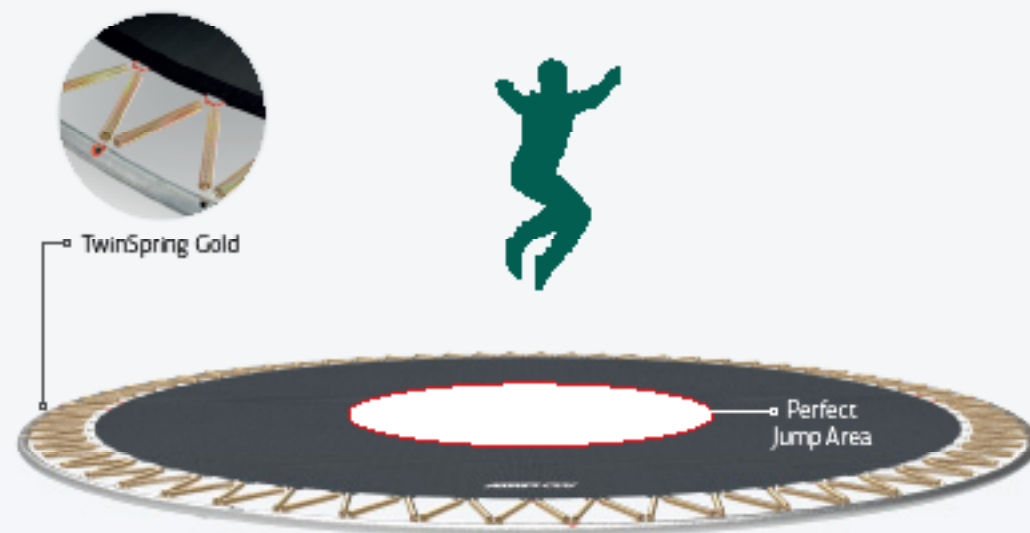
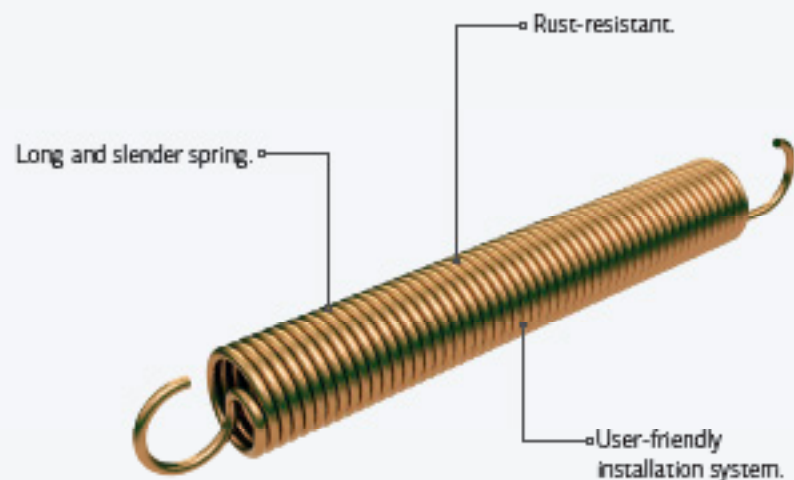



5. ROUND FRAME

The Champion has a solid frame of strong tubes with a substantial tube thickness and wall thickness. The frame is highly rust-resistant caused by the special double coating on the tube. The tubes are first provided with a durable zinc-layer and then covered with a beautiful black powder coating layer (InGround trampolines do not have this black powder coating). The frame is very easy to assemble.

The solid frame has tubes with a diameter of $1\frac{3}{20}$ " and a wall thickness of $\frac{2}{25}$ ".

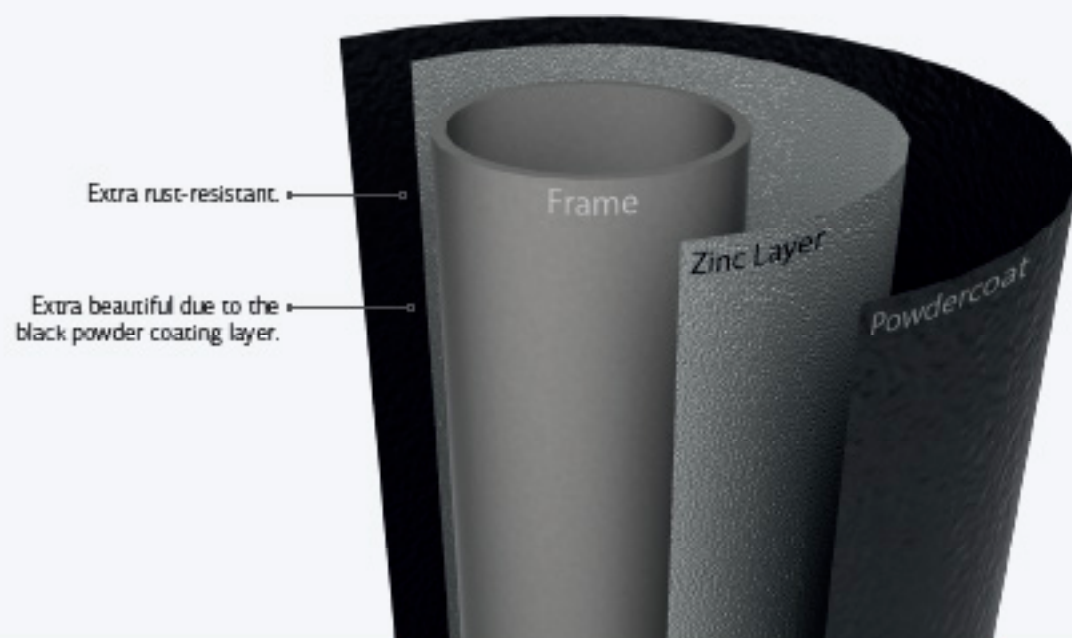



6. GRAND FRAME

The Grand Champion has a solid frame of strong tubes with a substantial tube thickness. The frame is highly rust-resistant caused by the special double coating on the tube. The tubes are first provided with a durable zinc-layer and then covered with a beautiful black powder coating layer. The frame is easy to assemble.

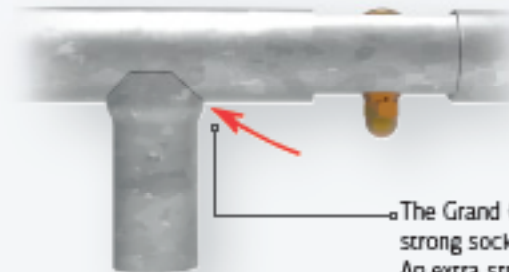
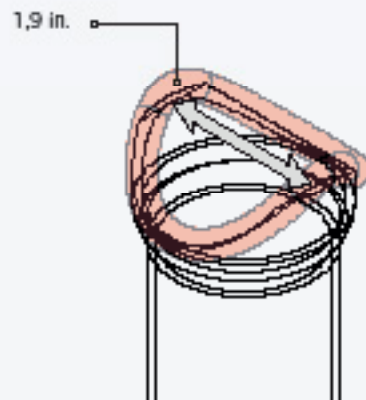
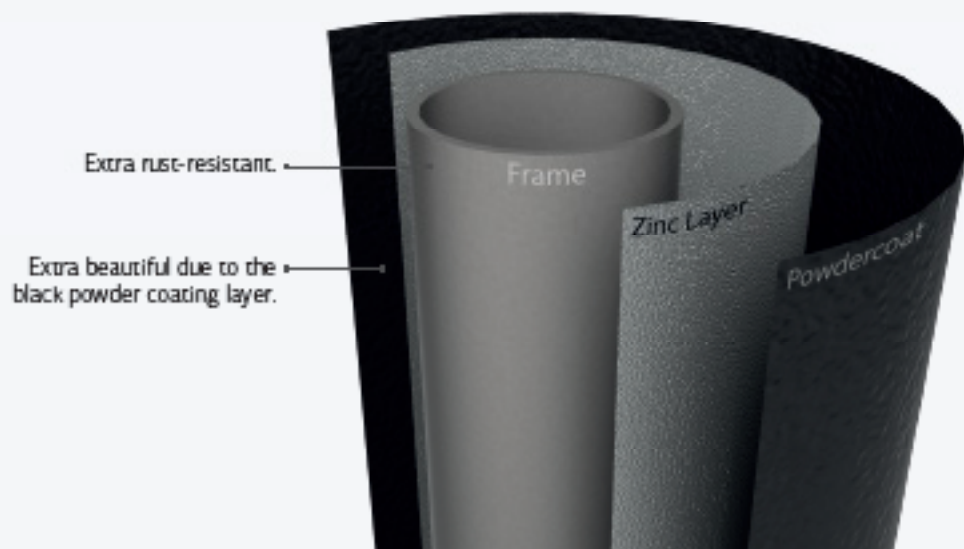

The Grand Champion has a strong socket of Ø1,9 in°. An extra strong weld seam is used for this socket.



7. ULTIM FRAME

The patented, rectangular Ultim Champion frame has a very strong profile of 4,7x2,4x0,08 inches. The top rail elements are firmly connected by 4 bolts. The solid frame does not move, creak or squeak.

The frame of the Regular and FlatGround is modular because the top rail is the same. The W-legs are separate elements, which makes transportation easier. Please refer to the table at the back of this product sheet for all tube/top rail diameters and step-on height.



The frame blocks the sand from entering the pit.

Extremely heavy duty frame.

The frame segments are joined together by four bolts and nuts at each transition to ensure a solid and noiseless construction.

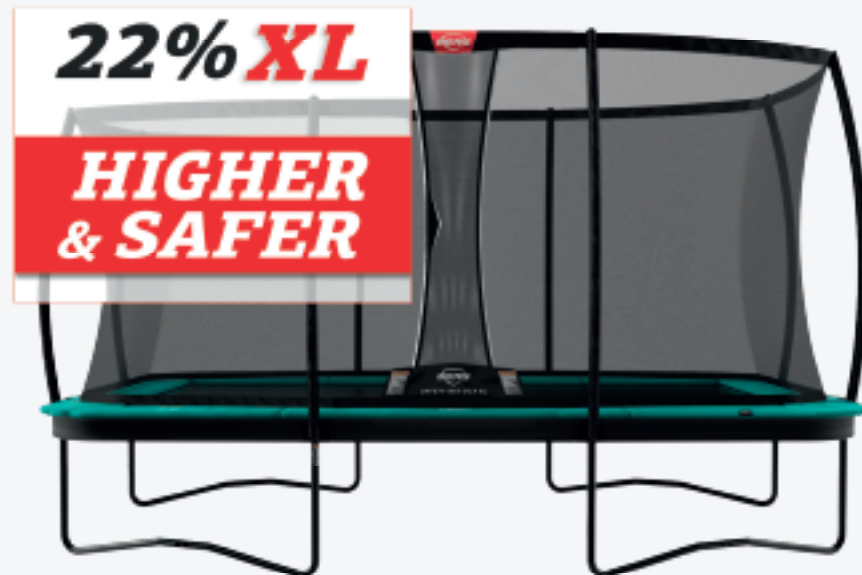

22% **XL**

**HIGHER
& SAFER**

Extra rustproof.

More attractive due to black powder coating.

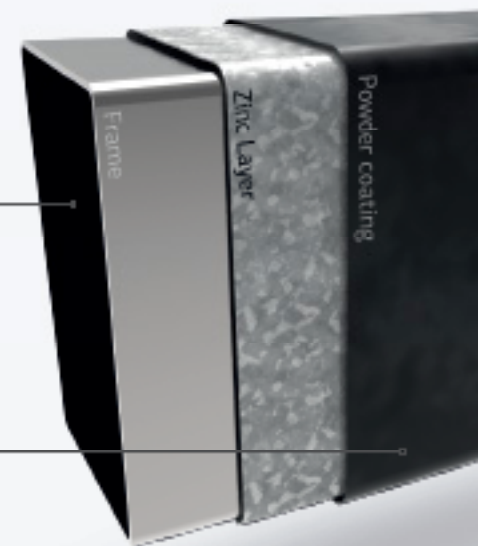

Frame

Zinc Layer

Powder coating



8. SAFETY NET DELUXE

Thanks to the reinforced upper edge (made of fibreglass poles), the Safety Net is always nice and taut.

Extra safe due to the thick layer of foam around the Safety Net poles.

The poles are equipped with sturdy clamps that are easy to assemble.

Extremely safe, self-closing entrance with distinctive trim.

The top caps of this trampoline connect the hoop to the poles. The caps have an easy click system and are therefore easy to attach.

The robust, curved poles provide more space between the Safety Net and the pole and therefore provide extra safety.

Having the net attached to the outer edge of the padding creates a larger jumping surface.

High-quality, dimensionally stable netting that feels soft to the touch.



9. SAFETY NET DELUXE XL

The Safety Net Deluxe XL is extra high (87 in). This makes the net extra safe. The high opening makes it easy to access the trampoline.

22% XL

**HIGHER
& SAFER**

Extra safe due to the thick layer of foam around the Safety Net poles.

The pole sleeve has a long split that can be closed with a strip of Velcro.

The Safety Net pole is attached to the clamp with an extra-long weld. The pole is therefore extra strong.

The poles are equipped with sturdy clamps that are easy to assemble on both the Regular and the FlatGround trampoline.

Extremely safe, self-closing entrance with distinctive trim.

The unique, rectangular-shaped hoop at the top of the Safety Net keeps the net nice and taut.

The top caps of this trampoline connect the hoop to the poles. The caps have an easy click system and are therefore easy to attach.

The robust, curved poles provide more space between the Safety Net and the pole and therefore provide extra safety.

Having the net attached to the outer edge of the padding creates a larger jumping surface.

High-quality, dimensionally stable netting that feels soft to the touch.



10. AEROWALL BLK&GRY

The unique AeroWall BLK&GRY is designed for practising (extreme) tricks by professional jumpers. The material that is used has the unique drop stitch technology that causes the wall to be surprisingly sturdy.

The wall is inflated and then attached to a strong and solid frame. This makes the wall very sturdy and suitable for jumping against. The inflatable Wall can easily be installed and removed from the frame in less than a minute work. When the frame is removed as well, the openings for the frame can be closed with special designed foam caps.



BERG Airpump.

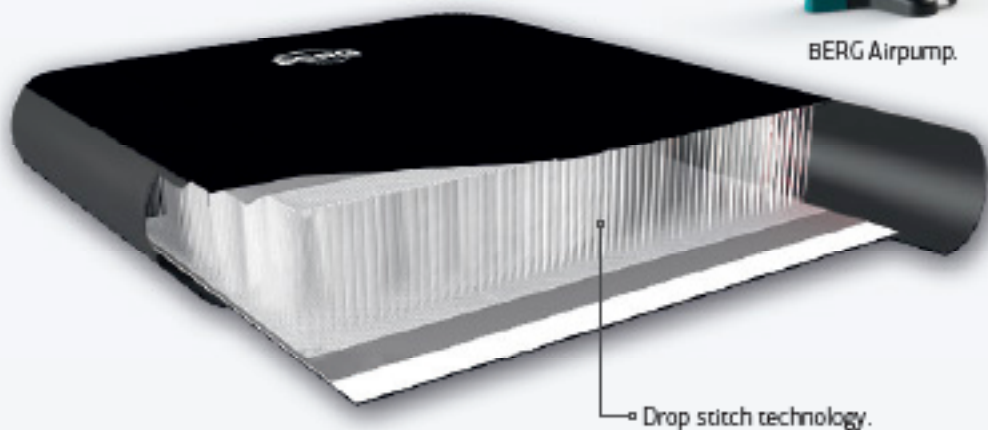

Foam caps for when the AeroWall BLK&GRY is not in use.

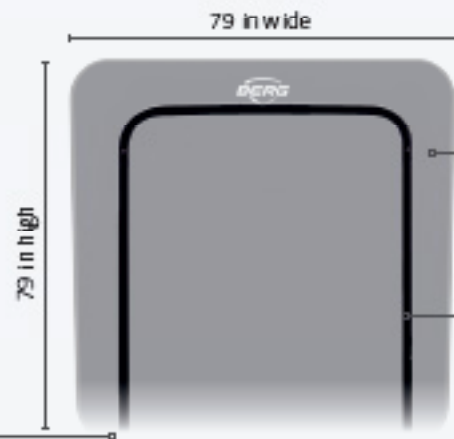

AeroWall BLK&GRY can be inflated in just several minutes!

Strong and easy to remove frame.

The AeroWall BLK&GRY is only possible in combination with the FlatGround.



TRAMPOLINE TYPES

Choose the unbeaten Champion



BERG Regular + Safety Net

If you prefer not to dig a hole in your garden, a high trampoline is a good choice. A high trampoline is easy to install and move around.



BERG InGround + Safety Net

The reduced height on an InGround trampoline means that the trampoline is less noticeable in the garden (does not block the view as much as a regular height trampoline).



BERG FlatGround + Safety Net

A FlatGround trampoline integrates seamlessly with your garden. This is because the protective edge of the trampoline is completely level with the garden. This ensures a very easy step-on. The Safety Net ensures that every user can jump safely.



BERG InGround (Sports) **SPORTS**

The sunken trampoline without safety net (Sports) is nicely concealed in your garden. The low threshold of 8 inches makes the trampoline easy and safe to step onto.



BERG FlatGround (Sports) **SPORTS**

A FlatGround trampoline integrates seamlessly with your garden. This is because the protective edge of the trampoline is completely level with the garden. This makes the trampoline unobtrusive and very easy to step onto.





BERG TRAMPOLINE

Choose the unbeaten Champion



Article number	Product name	Dimensions	Entrance height	Teatweight	Max user weight	Padding thickness	Width padding	Shape trampoline
35.41.80.00	BERG Champion Regular 11 ft Green + Safety Net Deluxe	11 ft	35 in	1100 lbs	220 lbs	1 1/4 in	15 in	Round
35.41.81.00	BERG Champion InGround 11 ft Green + Safety Net Deluxe	11 ft	8 in	1100 lbs	220 lbs	1 1/4 in	15 in	Round
35.41.67.00	BERG Champion InGround 11 ft Green	11 ft	8 in	1100 lbs	220 lbs	1 1/4 in	15 in	Round
35.44.80.00	BERG Champion Regular 14 ft Green + Safety Net Deluxe	14 ft	37 in	1325 lbs	265 lbs	1 1/4 in	15 in	Round
35.44.81.00	BERG Champion InGround 14 ft Green + Safety Net Deluxe	14 ft	8 in	1325 lbs	265 lbs	1 1/4 in	15 in	Round
35.44.67.00	BERG Champion InGround 14 ft Green	14 ft	8 in	1325 lbs	265 lbs	1 1/4 in	15 in	Round



BERG TRAMPOLINE

Choose the unbeaten Champion



Article number	Product name	Dimensions	Entrance height	Total weight	Max user weight	Padding thickness	Width padding	Shape trampoline
30.367.5.70	BERG Grand Champion Regular 17 ft Green + Safety Net Deluxe	17 ft	37 in	1325 lbs	265 lbs	1 1/4 in	15 in	Oval
30.347.5.70	BERG Grand Champion InGrossed 17 ft Green + Safety Net Deluxe	17 ft	11 in	1325 lbs	265 lbs	1 1/4 in	15 in	Oval
30.34.25.70	BERG Grand Champion InGrossed 17 ft Green	17 ft	11 in	1325 lbs	265 lbs	1 1/4 in	15 in	Oval



BERG TRAMPOLINE

Choose the unbeaten Champion





Article number	Product name	Dimensions	Entrance height	Teatweight	Max user weight	Padding thickness	Width padding	Shape trampoline
32.36.95.70	BERG Ultim Champion Regular 16 ft Green + Safety Net DLX XL	16 ft	35 in	1325 lbs	265 lbs	1 1/4 in	16 1/2 in	Rectangular
32.32.95.70	BERG Ultim Champion FlatGround 16 ft Green + Safety Net DLX XL	16 ft	0 in	1325 lbs	265 lbs	1 1/4 in	16 1/2 in	Rectangular
32.32.45.70	BERG Ultim Champion FlatGround 16 ft Green + AeroWall 2x2 BLK&GRY	16 ft	0 in	1325 lbs	265 lbs	1 1/4 in	16 1/2 in	Rectangular
32.32.25.70	BERG Ultim Champion FlatGround 16 ft Green	16 ft	0 in	1325 lbs	265 lbs	1 1/4 in	16 1/2 in	Rectangular



BERG TRAMPOLINE ACCESSORIES

Choose the unbeaten Champion

Accessory	Article number
 BERG Framenet Extra 330 (11 Ft)	33.80.11.01
 BERG Framenet Extra 430 (14 Ft)	33.80.14.01





BERG TRAMPOLINE ACCESSORIES

Choose the unbeaten Champion

Accessory

Article number

1 BERG Ladder Large

55.90.14.00



The steps are covered with an anti-slip material that allows water to seep through it.





BERG TRAMPOLINE ACCESSORIES

Choose the unbeaten Champion

Accessory	Article number
 BERG Anchor set	35.99.10.00



Secure your trampoline more firmly with this anchor set for even more safety.





BERG TRAMPOLINE ACCESSORIES

Choose the unbeaten Champion

Summary	Art. no.
 BERG Weather cover Eclis Green 208 (11 ft)	53.885.900
 BERG Weather cover Eclis Green 408 (14 ft)	53.885.902
 BERG Great Weather cover Eclis Green (17 ft)	53.885.904
 BERG Ultra Weather cover Eclis Green (18 ft)	53.885.908



