

Alva

SITS



Alva

UPHOLSTERY

COMFORTS

COVERS

SPECIAL



fabric



STD standard



CLS classic



FC fixed



modular system

All elements available also as freestanding elements.

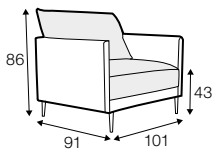

armchair

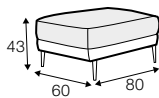

footstool

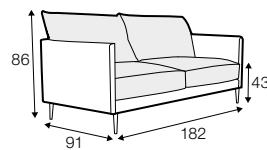

2 seater

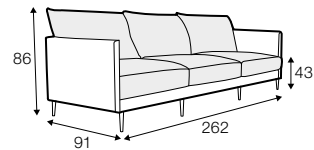

3 seater

seat elements

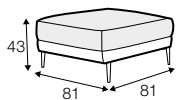

seat element 80

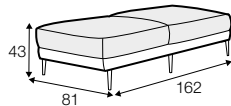

seat element 160

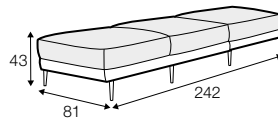

seat element 240

unlimited possibilities of combinations - below example arrangements

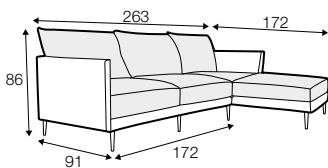

2x seat element 160
+ 5x armrests
+ 3x cushion 81

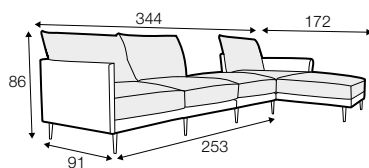

2x seat element 160
+ seat element 80
+ 5x armrests
+ 3x cushion 81

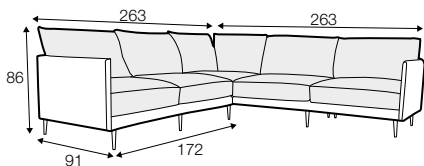

2x seat element 160
+ seat element 80
+ 8x armrests
+ 5x cushion 81
+ cushion 67

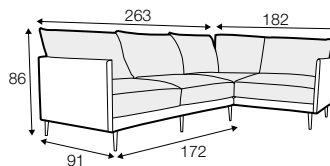

seat element 160
+ 2x seat element 80
+ 7x armrests
+ 4x cushion 81
+ cushion 67

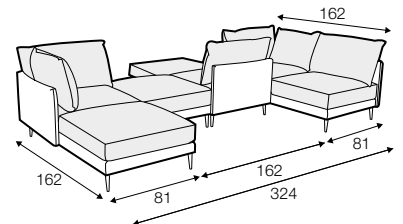

3x seat element 160
+ seat element 80
+ 6x armrests
+ 2x cushion 67
+ 4x cushion 81

extra dimensions

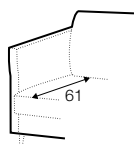

depth of seat

accessories

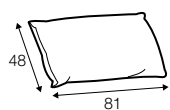

cushion 81x48

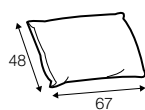

cushion 67x48

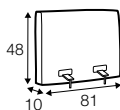

armrest/backrest
available in loose cover

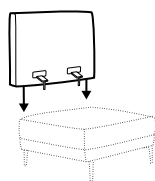

legs

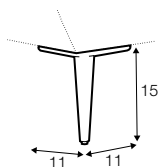

no. 128
aluminium
or aluminium
painted black

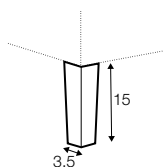

no. 109
wood

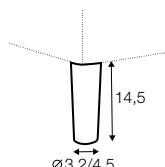

no. 153
wood

profile

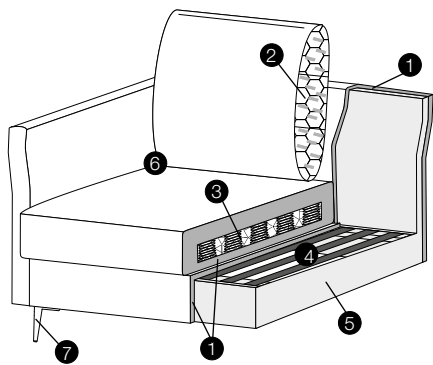

standard

1. polyurethane/laminated foam
2. foam flakes with silicone balls
3. bonnell springs
4. upholstery belts
5. FSC® certified solid wood and wood based elements
6. fabric
7. FSC® certified solid wood or metal legs

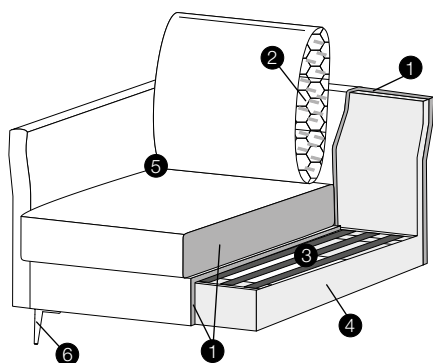

classic

1. polyurethane/laminated foam
2. foam flakes with silicone balls
3. upholstery belts
4. FSC® certified solid wood and wood based elements
5. fabric
6. FSC® certified solid wood or metal legs