

AC240

Portable Power Station

User Manual v1.0

Please read this manual carefully before use and keep it for future reference.



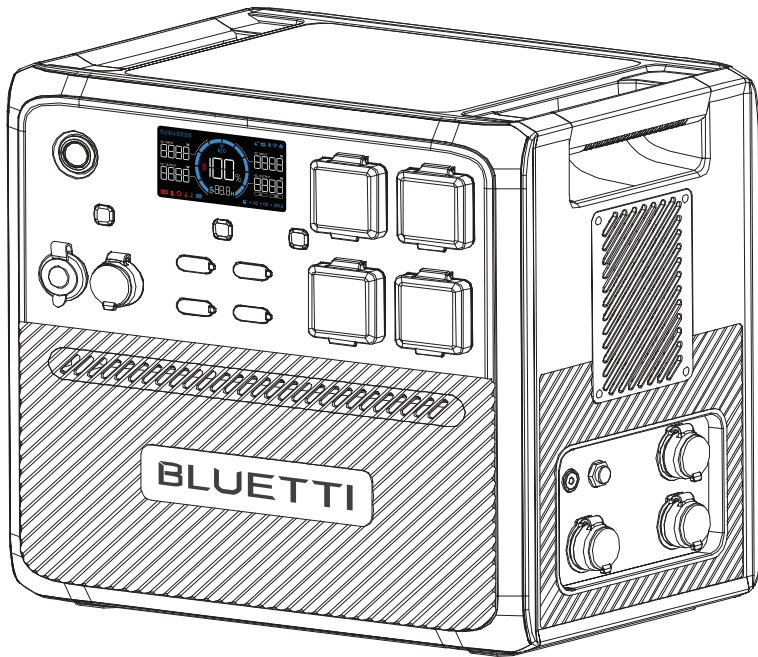

Warning

1. Charge the unit before first use.
2. Do not use solar panels with open circuit voltage higher than 60V. Solar input voltage range for the unit is 11V-60VDC.
3. Charge the unit immediately when the SoC drops below 5%. If the SoC drops to 0, power off the unit and charge it for at least 30 minutes before restarting.
4. The unit is for off-grid use only. Do not connect its AC output to the grid.
5. If not used for more than 3 months, charge the unit to 40%-60% SoC and store it with the power off. For optimum battery life, discharge and charge the unit every 3 months.

Thank You!

Thank you for making BLUETTI a part of your family.

From the very beginning, BLUETTI has tried to stay true to a sustainable future through green energy storage solutions while delivering an exceptional eco-friendly experience for our homes and our world.

That's why BLUETTI makes its presence in 100+ countries and is trusted by millions of customers across the globe.



Copyright © Shenzhen PowerOak Newener Co., Ltd. All rights reserved.

No part of this document may be reproduced or transmitted in any form or by any means without the prior written consent of Shenzhen PowerOak Newener Co., Ltd.

Notice

BLUETTI's products, services, and features are subject to the agreed-upon terms and conditions during purchase. Please note that some products, services, or features described in this manual may not be available under your purchase contract. Unless otherwise specified in the contract, BLUETTI makes no representations or warranties of any kind, express or implied, with respect to the contents of this manual.

The contents of this manual are subject to change without notice. Please get the latest version from: <https://www.bluettipower.com/pages/user-guides>

If you have any questions or concerns about this manual, please contact BLUETTI support for further assistance.

Contents

1	Safety Instructions	05
2	Packing List	09
3	Product Introduction	11
4	Product Overview	12
5	Power ON / OFF	13
6	LED Screen	14
7	Charging	16
8	Discharging	19
9	Settings	20
10	AC240 + B210 Expansion Connection	24
11	BLUETTI App	25
12	Specifications	25
13	Button Operation Instructions	27
14	Troubleshooting	28
	Appx.1 Estimating Operation Time	29
	Appx.2 FAQ	30

1. Safety Instructions

Read this manual for instructions on the proper use and safety information for the product. The safety instructions provided herein are for illustrative purposes that include but are not limited to those listed in this manual. Actual operation shall comply with all applicable safety standards. If you have any questions, feel free to contact BLUETTI support or your local BLUETTI dealers.

1.1 Statement

To ensure a safe operation, it's crucial to observe and adhere to the following conditions:

- Always operate or store the product in the conditions specified in this manual.
- Avoid unauthorized disassembly, component replacement, or modification of software codes.

⚠ BLUETTI shall not be liable for damages resulting from the following circumstances:

- Force majeure events such as earthquakes, fires, storms, floods, or mudslides.
- Damage caused by the customer's own transportation.
- Damage resulting from inadequate storage conditions as specified in the manual.
- Damage caused by customer negligence, improper operation, or intentional actions.
- System or hardware damage caused by third parties or customers, including but not limited to improper handling and installation not in accordance with the instructions in this manual.
- Usage of the product with devices that require a high-performance Uninterruptible Power Supply (UPS), including but not limited to data servers, workstations, medical equipment, and other similar devices.

1.2 General Requirements

INSTRUCTIONS PERTAINING TO RISK OF FIRE, ELECTRIC SHOCK, OR INJURY TO PERSONS
IMPORTANT SAFETY INSTRUCTIONS

WARNING:

When using this product, basic precautions should always be followed, including the following:

- Read all the instructions before using the product.
- To reduce the risk of injury, close supervision is necessary when the product is used near children.
- Do not put fingers or hands into the product. And do not insert foreign objects into any

ports of the product.

- Use of an attachment not recommended or sold by the manufacturer may result in a risk of fire, electric shock, or injury to persons.
- To reduce the risk of damage to the electric plug and cord, pull the plug rather than the cord when disconnecting the product.
- Do not use a battery pack or appliance that is damaged or modified, as they may exhibit unpredictable behavior resulting in fire, explosion, or personal injury.
- Do not operate the product with a damaged cord or plug, or a damaged output cable.
- Do not attempt to replace the internal battery or any other component of the product by anyone other than authorized personnel. There are no end-user serviceable components. Do not disassemble the product, take it to a qualified service person when service or repair is required. Incorrect reassembly may result in a risk of fire or electric shock.
- To reduce the risk of electric shock, unplug the product from the outlet before attempting any instructed servicing.
- **WARNING - RISK OF EXPLOSIVE GASES.** To reduce the risk of battery explosion, follow these instructions and those published by the battery manufacturer and manufacturer of any equipment you intend to use in the vicinity of the battery. Review cautionary markings on these products and engines.
- **PERSONAL PRECAUTIONS**
 - a. Wear complete eye protection and clothing protection. Avoid touching eyes while working near the battery.
 - b. Never smoke or allow a spark or flame in the vicinity of the battery or engine.
 - c. Be extra cautious to reduce the risk of dropping a metal tool onto the battery. It might spark or short-circuit the battery or other electrical parts which may cause an explosion.
- When charging the internal battery, work in a well ventilated area and do not restrict ventilation in any way.
- Under abusive conditions, liquid may be ejected from the battery; avoid contact. If contact accidentally occurs, flush with water. If liquid contacts eyes, additionally seek medical help. Liquid ejected from the battery may cause irritation or burns.
- Do not expose the product to fire or excessive temperature. Exposure to fire or temperature above 80°C (176°F) may cause an explosion.
- Have servicing performed by a qualified repair person using only identical replacement parts. This will ensure that safety is maintained.

· Do not stack anything on top of the product while in storage or while in use. Do not move the product while operating as vibrations and sudden impacts may lead to poor connections to the hardware inside.

· CAUTION: Do not use this product in the rain

· In case of fire, use only a dry powder fire extinguisher appropriate for the product.

· WARNING - RISK OF ELECTRIC SHOCK. Never use the product to supply power tools to cut or access live parts or live wirings, or materials that may contain live parts or live wirings inside, such as building walls, etc.

1.3 Grounding Instructions

The product is designed for portable use and typically does not require earth grounding. However, if you connect it to the power grid, it's important to ensure proper grounding for safety. If it should malfunction or break down, grounding provides a path of least resistance for electric current to reduce the risk of electric shock. This product is equipped with an AC power cord having an equipment-grounding conductor and a grounding plug. The plug must be plugged into an outlet that is properly installed and grounded in accordance with all local codes and ordinances.

WARNING:

Improper connection of the equipment-grounding conductor can result in a risk of electric shock. Check with a qualified electrician if you are in doubt as to whether the product is properly grounded. Do not modify the plug provided with the product - if it does not fit the outlet, have a proper outlet installed by a qualified electrician.

1.4 Handling Requirements

During transportation or storage, take care to avoid dropping, violently impacting, or tilting the product as it may result in internal damage. If necessary, use mechanical assistance such as carts or adjustable height workbenches to ensure safe handling.

Recommended number of people based on the weight of product

Weight	Number of people
<18kg (39.7lbs)	1
18kg~32kg (39.7lbs~70.5lbs)	2
32kg~55kg (70.5lbs~121.3lbs)	3
>55kg (121.3lbs)	4 or a cart

1.5 Storage Instructions

· When the SoC drops to 5%, please charge the product immediately.

· Before storing the product, charge it to 40% to 60% SoC to keep it in optimal condition.

In addition, power off the unit and disconnect all electrical connections from it.

- Store the product in a cool and dry place, keeping it away from flammable or combustible materials and gases.
- The product can be safely stored within a temperature range of -20°C to 45°C (-4°F to 113°F). However, if the storage duration exceeds one month, it's recommended to maintain an ideal storage temperature of around 30°C (86°F).
- Fully cycle the product every 3 months to maintain the battery's health. It's NOT recommended to store the unit for extended periods of time, as it may affect its performance and overall lifespan.

If the SoC drops to 0 (during storage or upon startup), take the following actions to safely restart the product:

- Shut down immediately.
- Charge within 48 hours.
- Keep it at an ambient temperature of 5°C to 35°C (41°F to 95°F) for 6 hours before charging. It's recommended to charge the product via an AC source. If charging via solar energy, ensure that your solar system provides an output of more than 100W.

 The symbol displayed is intended to remind you to read the instructions in the literature accompanying the product before operation and maintenance.





- Connect the product to a socket-outlet that has an earthing connection using the power cord provided.
- The socket-outlet should be installed near the product and easily accessible for safety purposes.
- Never dispose of a battery by throwing it into fire or a hot oven, or by mechanically crushing or cutting it, as these may cause it to explode.
- Avoid leaving batteries in extremely high-temperature environments, as this can result in an explosion or the leakage of flammable liquid or gas.
- The battery subjected to extremely low air pressure may result in an explosion or the leakage of flammable liquid or gas.
- Attention should be drawn to the environmental aspects of battery disposal.
- Please refer to the information on the exterior bottom enclosure for electrical and safety information before installing or operating the apparatus.

SAVE THESE INSTRUCTIONS

 **BLUETTI shall not be liable for any equipment damage caused by the violation of the above instructions.**

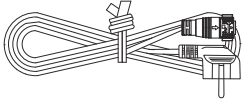
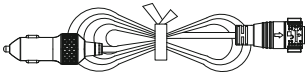
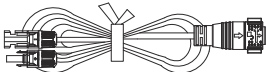

2. Packing List

Standard Accessories

Item	Picture	Qty.
Portable Power Station		1
AC Charging Cable		1
Car Charging Cable		1
Solar Charging Cable		1
Grounding Screw		1
User Manual		1
Warranty Card		1

Optional Accessories

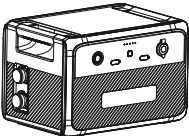
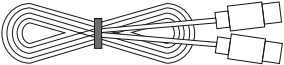
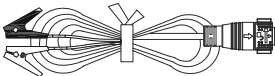
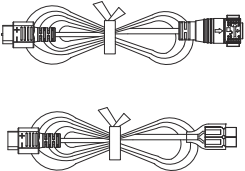
(Available on the official BLUETTI website: <https://www.bluettipower.com>)

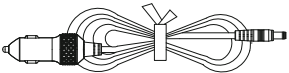
Item	Picture
B210 Expansion Battery	 A rectangular expansion battery with a control panel on the front featuring several buttons and a display screen.
USB-C to USB-C Cable (output)	 A coiled USB-C to USB-C cable with both ends having the standard USB-C connectors.
Lead-acid Battery Charging Cable (Charge the AC240 via a lead-acid battery)	 A charging cable with a multi-pin connector on one end and a standard AC power plug on the other.
RV Power Cable (For RV's 12V devices)	 Two coiled power cables with different connectors, one featuring a multi-pin connector and the other a different type of multi-pin connector.
PV Voltage Regulator (Convert high solar panel voltage to a suitable level for battery charging)	 A small, rectangular electronic device with two cables extending from it, one ending in a multi-pin connector and the other in a different type of connector.
12V Power Cable (For 12V devices with DC5521 port, such as routers, cameras, etc.)	 A coiled power cable with a DC5521 connector on one end and a standard multi-pin connector on the other.

3. Product Introduction

Meet the BLUETTI AC240 Power Station, an exceptional energy solution for travel enthusiasts who demand the best. With a massive 2,400W output, it can power everything from small electronics to large RV appliances.

Not only that, but the AC240 also boasts an impressive battery capacity that ranges from 1,536Wh to a staggering 10,136Wh with four B210 expansion batteries. And if you need even more power, you can simply connect another AC240 for uninterrupted power for days on end.

Managing the AC240 is a breeze thanks to the BLUETTI App, which lets you control the unit's various functions and settings with ease. With features like ECO Mode and UPS Mode, you can optimize your power consumption and protect your device at all times. Whether you're camping or on a road trip, the AC240 provides a reliable and easy-to-use energy solution for your on-the-go lifestyle.

Danger:

Do not connect the AC output of AC240 to the grid.

4. Product Overview

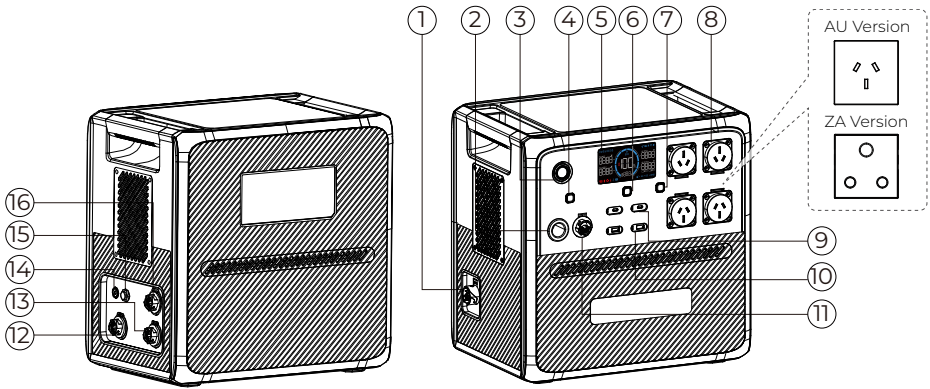

① Battery Expansion Port

② Cigarette Lighter Port

③ Power Button

④ DC Power Button

⑤ LED Screen

⑥ USB Power Button

⑦ AC Power Button

⑧ AC Output

⑨ USB-C Port

⑩ USB-A Port

⑪ RV Port

⑫ DC Input

⑬ AC Input

⑭ Grounding Pole

⑮ Bleed Valve

⑯ Parallel Port(Reserved Functional Interfaces)

5. Power ON / OFF

Attention:

Please place the unit on the platform firmly and stably.

- Power ON: Press the Power Button and the button lights up indicating that the AC240 is now on standby.
- Power OFF: Press and hold the Power Button for 2 seconds to turn off the unit.
- AC ON / OFF: When the AC240 is on, press the AC Power Button to turn it on / off.
- USB ON / OFF: When the AC240 is on, press the USB Power Button to turn it on / off.
- DC ON / OFF: When the AC240 is on, press the DC Power Button to turn it on / off.

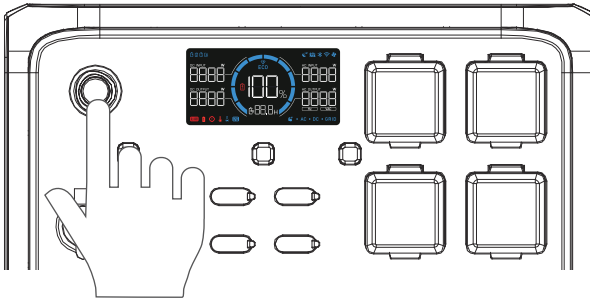





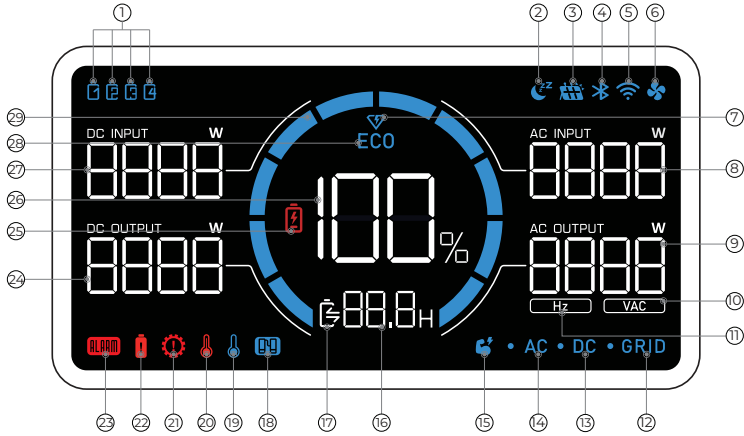

























6. LED Screen

The AC240 features an informative LED screen that offers easy access to all the essential information about the unit's status and performance. When you power on the unit, the LED screen lights up, and when you power off the unit, the screen turns off as well.



- | | | |
|------------------------|-------------------------------------|-------------------------------|
| ① Expansion Battery | ⑫ Grid Connection | ⑳ Overcurrent Alert |
| ② Silent Charging | ⑬ DC Output | ㉑ Fault Alert |
| ③ DC Input | ⑭ AC Output | ㉒ DC Output Power |
| ④ Bluetooth Connection | ⑮ Power Lifting Mode | ㉓ Low Battery Alert |
| ⑤ WiFi Connection | ⑯ Charge / Discharge Remaining Time | ㉔ Battery Capacity (SoC) |
| ⑥ Fan Status | ⑰ Charge / Discharge Status | ㉕ DC Input Power |
| ⑦ Turbo Charging | ⑱ Parallel Connection | ㉖ ECO Mode |
| ⑧ AC Input Power | ⑲ Low Temperature Alert | ㉗ Charge / Discharge Progress |
| ⑨ AC Output Power | ㉘ High Temperature Alert | |
| ⑩ AC Output Voltage | ㉙ Overload Alert | |
| ⑪ AC Output Frequency | | |

LCD Instructions	
Startup	LCD lights up
Shutdown	LCD lights off
Each icon represents an attached expansion battery. The AC240 can display up to 4 battery icons.	
The AC240 is charging in Silent Charging Mode.	
The AC240 is charging from a DC power source, such as solar panels, lead-acid batteries, etc.	
The AC240 connects to BLUETTI App via Bluetooth.	
The AC240 connects to BLUETTI App via WiFi.	
When it lights up, the fan is activated and working properly. If it flashes, there may be a problem with the fan.	
The AC240 is charging in Turbo Charging Mode.	
The real-time AC charging power.	
The real-time total AC output power.	
The real-time AC output voltage.	
The real-time AC output frequency.	
The AC240 is charging from the home grid.	
The DC output is turned on.	
The AC output is turned on.	
The AC240 is operating in Power Lifting Mode.	
The remaining time of charging or discharging.	
 : Charging  : Discharging	
The AC240 is operating in parallel mode with another AC240 unit.	
The temperature inside the unit is lower than -20°C (-4°F).	
The temperature inside the unit is higher than 70°C (158°F).	
The AC240 is overloaded.	
The AC240 is drawing too much current, which can cause damage to the unit or any connected devices.	
There's an issue with the AC240, which may require troubleshooting or repair.	
The real-time DC output power.	
The SoC drops below 5%.	
The remaining battery capacity.	
The real-time DC input power.	
The ECO Mode is activated to save power.	
The bar increases during charging and decreases during discharging.	

7. Charging

AC240 supports four charging methods: AC, solar, car, generator, and Lead-acid battery.

Attention:

- Double-check that all cables are firmly plugged in.
- Avoid getting the plug and socket wet to prevent any potential damage.

7.1 AC Charging

Plug the AC240 into a standard wall outlet and start charging. Once it's fully charged, the AC240 automatically stops charging to prevent overcharging. For a fast charge, you can enable Turbo Charging in the BLUETTI App, which allows for an 80% capacity in just 45 minutes at an ambient temperature of 25°C (77°F).

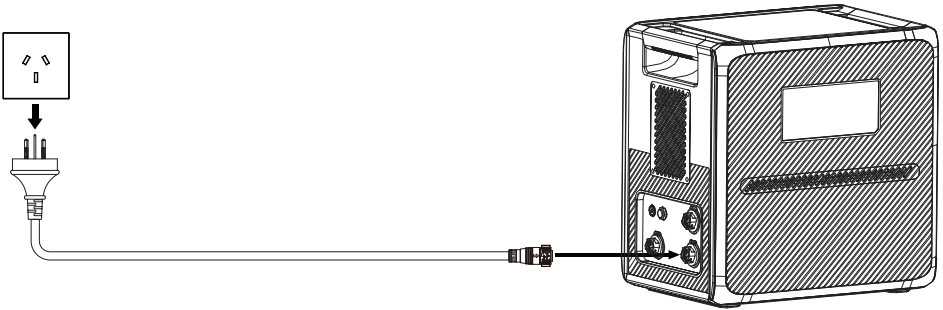

7.2 Solar Charging

Connect the solar panels (in series or parallel) to AC240 via the solar charging cable. When receiving a continuous input of 1200W, the AC240 can be charged up to 80% in about 1.3 hours. However, please be aware that the charging time may vary based on weather conditions, sunlight intensity, panel orientation, and other variables.

Note:

- Make sure your solar panels meet the following requirements:
Voc: 11V-60V Current: 21A Max. Power: 1200W Max.
- Non-waterproof solar panels will lose efficiency if they get exposed in the rain for a long time.

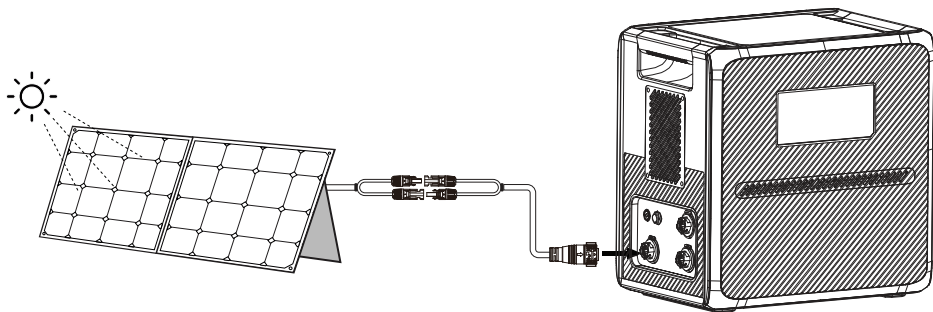

⚠ Attention:

For solar panels with an open circuit voltage between 60V and 145V, you can still use them to charge the AC240. Simply connect the solar panels to the AC240 via the PV Voltage Regulator, and you can enjoy seamless and hassle-free solar charging.

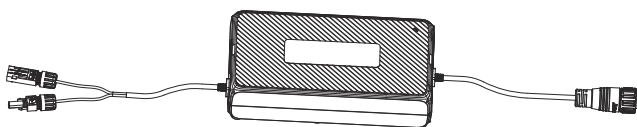

7.3 Car Charging

Connect AC240 to the vehicle's 12V/24V cigarette lighter port via the car charging cable. The AC240 automatically stops charging once it's fully charged.

Note: Make sure your vehicle meets the following conditions for charging:

- The vehicle is capable of supplying power with a maximum current of 8.2A.
- The vehicle's engine is running during the charging process.

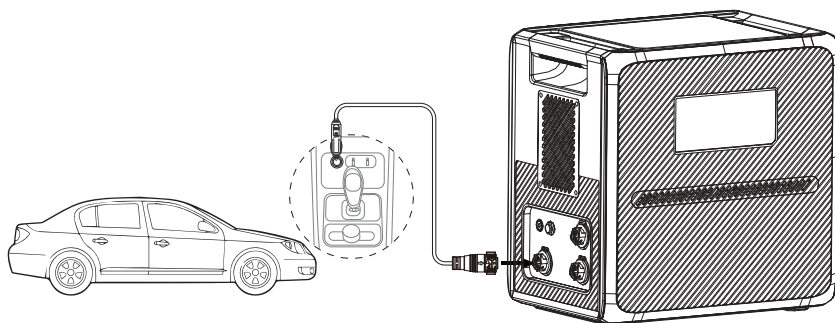

7.4 Generator Charging

Connect the AC240 to a generator via the AC charging cable. The AC240 also automatically stops charging when it's fully charged.

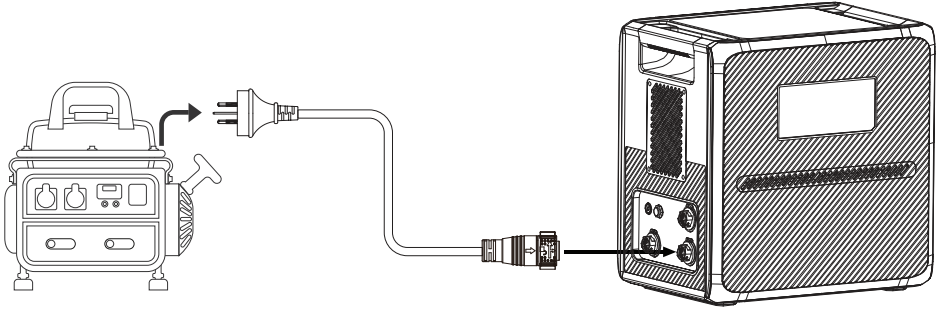

Note: Make sure your generator delivers the AC output with charging voltage, frequency, and Grid Self-adaption Mode voltage that meet AC240's specifications.

If the total power demand of your connected devices exceeds the generator's output capacity, please turn on the Grid Self-adaption Mode to ensure a seamless charging experience.

7.5 Lead-acid Battery Charging

In this method, the AC240 is charged by connecting the lead-acid battery and the AC240 DC/PV port via the optional lead-acid battery charging cable, as shown in the figure below.

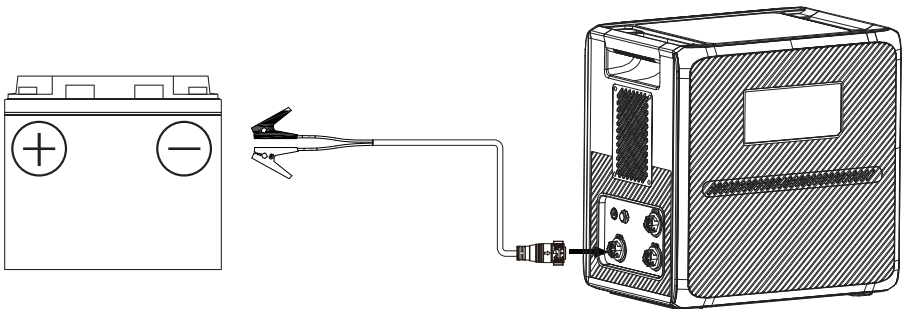





8. Discharging

Besides the cigarette lighter port, USB-A, and USB-C, AC240 also features two types of AC outlets and an RV port, expanding your charging options.

8.1 AC Discharging

Port	Description
AC Outlet x 4	For AC electrical devices.

8.2 DC Discharging

Port	Picture	Specifications	Compatible Loads
Cigarette Lighter Port x1		12V / 10A	12V DC appliances.
USB-A x 2		QC 3.0, 18W Max.	Mobile phones and other small loads.
USB-C x 2		PD 3.0, 100W Max.	Mobile phones, laptops, etc.
RV Port x1		12V / 30A	RV's 12V DC appliances.

Note: To ensure optimal performance, avoid short-circuiting the ports and keep them dry during use or storage. Additionally, do not block or cover the ports while ensuring proper ventilation.

The AC240 has a maximum DC output of 430W. If the real-time output is exceeded, the AC240 turns off the USB output first to lower the total output. The screen flashes the  and **ALARM**, and the USB power button indicator flashes.

If the real-time output is still exceeded, the AC240 shuts off all DC output. The screen flashes the  and **ALARM**, the USB indicator goes off, and the DC power button blinks.

9. Settings

The AC240 offers the convenience of adjusting its settings either via the LED screen or the BLUETTI App. With the unit's LED screen, you have direct control over various settings such as Power Lifting Mode, ECO Mode, output frequency, and charging modes. Additionally, by using the BLUETTI App, you can access a user-friendly interface on your phone to conveniently monitor and control the AC240.

9.1 Setting Mode

When the screen is on, press and hold the AC and DC Power Buttons for about 2 seconds till the output frequency flashes to enter the Setting Mode.

9.2 ECO Mode

The AC240 has two ECO modes that help you save power and extend battery life:

- AC-ECO Mode

In this mode, if the AC power output falls below a certain level for a set period of time, the AC power will automatically turn off.

Note: This mode is not available when the AC240 is charging from an AC source like a wall outlet or generator.

- DC-ECO Mode

In this mode, if the DC power output falls below a certain level for a set period of time, the DC power will automatically turn off.

Attention:

- The AC-ECO and DC-ECO modes are enabled by default to save energy, and it's recommended to keep them enabled at all times.
- Use the BLUETTI App to enable or disable AC-ECO Mode and DC-ECO Mode separately. If you use the LED screen, they'll be turned on or off at the same time.
- To avoid any interruption in charging, disable ECO Mode when charging a small device that consumes less than 60W of power.



In the Setting Mode, press the DC Power Button to navigate through the setting items. When the **ECO** icon flashes on the screen, press the AC Power Button to enable or disable the ECO Mode.

9.3 Frequency Switching

The current output frequency (50Hz / 60Hz) is displayed in the lower right corner of the screen. In the Setting Mode, press the DC Power Button to navigate until the output frequency appears on the screen. Then, press the AC Power Button to switch the frequency options based on your requirements.

Note: Turn off AC Power Button before setting Frequency.

9.4 WiFi & Bluetooth Connection

To connect the AC240 to the BLUETTI app, turn on the WiFi or Bluetooth first. In the Setting Mode, press the DC power button to navigate through the setting items. When the  icon flashes on the screen, press the AC power button to turn Bluetooth on. Similarly, when the  icon flashes on the screen, press the AC power button to toggle WiFi on.

Note: Bluetooth and WiFi on by default



9.5 Power Lifting Mode



The Power Lifting Mode is specifically designed to handle resistive loads up to 3,600W, including electric blankets, kettles, hairdryers, and other heating devices. To enable it, access the Setting Mode, navigate with the DC Power Button until the  appears, and press the AC Power Button to enable the mode.

Note: The Power Lifting Mode is not enabled by default and is only suitable for resistive loads with a power rating between 2,400W-3,600W.

Although the AC240 can handle higher power demands, its actual operating power remains at 2,400W.

9.6 AC Charging Mode

The AC240 supports 3 AC charging modes - Standard, Turbo, and Silent to fit your specific needs. In the Setting Mode, use the DC power button to navigate until the  or  icon starts flashing on the screen. Then, press the AC power button to choose the charging modes. Please refer to the table below for useful instructions.

Mode	Recharging Power			Description	Note	Icon
	AC	PV	AC+PV			
Standard	800W Max.	800W Max.	800W Max.	Fully charged in about 3 hours	More friendly to AC240's battery.	None
Turbo	2200W Max.	1200W Max.	2200W Max.	80% charge in 45 minutes	Comes in handy when recharging time is a priority.	
Silent	800W Max.	800W Max.	800W Max.	Low operation noise less than 45dB	Offers a quiet, low-power operation for long battery life.	

9.7 UPS Mode

With the UPS mode enabled, the AC240 can provide uninterrupted power to your essential appliances during a power outage. And there are four different modes available through the BLUETTI App, allowing you to choose the best option for your needs.

· Standard UPS Mode

In this mode, the AC240 and its expansion batteries (if any) are always charged using available solar or grid power, ensuring that they are ready to provide backup power in case of a grid failure. When the grid fails, the AC240 units seamlessly take over to keep your devices running without any interruption.

· Time Control UPS Mode

This mode allows you to program the AC240 to charge during off-peak hours when electricity is cheaper. Then, during peak hours when electricity is more expensive, the AC240 seamlessly switches over to power your devices, helping you to save money on your electricity bills.

· PV Priority UPS Mode

In this mode, the AC240 is mainly charged by solar energy to save power. You can also set a specific State of Charge (SoC) threshold. AC240 charges from the grid until reaching the designated SoC, and then seamlessly switches to solar charging for the remaining capacity.

· Customized UPS Mode

Tailor your UPS settings to match your unique needs in this mode. Create personalized schedules for charging and discharging, set battery SoC limits, and even control the grid charging switch and scheduled charging switch according to your diverse requirements.

9.8 Grid Self-adaption Mode

If you can not charge the AC240 using a generator or unstable grid voltage because of unstable voltage, it is recommended that you enable the Grid Self-adaption Mode through the BLUETTI App to ensure a stable, safe charging experience for both the AC240 and your devices.

9.9 Max. Grid Input Current

The Max. Grid Input Current is set to 10A by default. If the grid current doesn't match this setting, adjust the setting in the BLUETTI App.

Attention:

If you need to increase the setting beyond the default 10A, please contact BLUETTI Customer Service and request a password to make the necessary adjustments.

9.10 Exit Setting Mode

To save your AC240 settings and exit the Setting Mode, press and hold down both the DC and AC Power Buttons at the same time.

Note: If you do not perform any operation in 1 minute, the AC240 will automatically exit the Setting Mode, and no changes will be saved.

10. AC240 + B210 Expansion Connection

The AC240 unit supports up to 4 B210 expansion batteries, providing a total capacity of up to 10,136Wh. Follow these steps to connect the two units:

1. Make sure both the AC240 and B210 are turned off.
2. Connect them using the battery expansion cable.
3. Power the AC240 on and the B210 turns on automatically. The  displays on the AC240's screen.

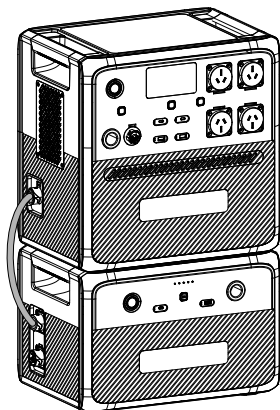

If you want to add more B210 units, please set up the system as shown.

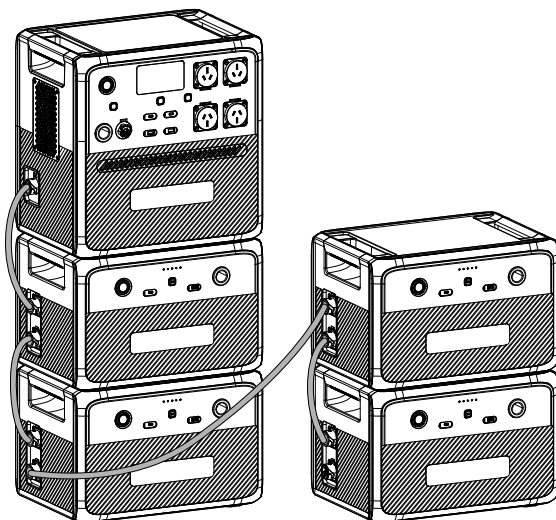

Attention:

The AC240 connects to the upper battery expansion port of B210.

11. BLUETTI App

Scan the QR code below or search "BLUETTI" in the App Store or Google Play to download the BLUETTI App.







For more details, please refer to BLUETTI APP INSTRUCTIONS.

12. Specifications

Model	AC240
Battery Capacity	1,536Wh (30Ah)
Cell Type	Lithium Iron Phosphate (LiFePO ₄ , LFP)
AC + DC Input	2,400W Max.
AC+DC Output	2,500W Max.
Weight	33kg / 72lbs
Dimensions (L × W × H)	419.5mm × 293.5mm × 409.5mm / 16.5in × 11.6in × 16.1in
Charging Temperature	0°C to 40°C
Discharging Temperature	-20°C to 40°C
Storage Temperature	Up to 1 month: -20°C to 40°C Up to 3 months: -20°C to 30°C Up to 12 months: -20°C to 25°C
Working Humidity	10% to 90%
Noise	53dB
Working Altitude	2,000m / 6,561ft











AC Output	
Power	2,400W in total
Overload Power	2500W<load<3000W@2min; 3000W<load<3600W@10s; 3600W<load@500ms;
Voltage	230VAC
Current	10.5A
Frequency	50Hz / 60Hz
DC Output	
Cigarette Lighter Port × 1	12VDC / 10A
USB-A × 2	18W Max. (QC3.0: 5V / 3A; 9V / 2A; 12V / 1.5A)
USB-C × 2	100W Max. (PD3.0: 5 / 9 / 12 / 15 / 20V 3A; 20V / 5A, with built-in EMarker chip)
RV Port × 1	12VDC / 30A
Total DC Output Power	430W
AC Input	
Voltage	230VAC
Current	10.5A
Frequency	50Hz / 60Hz
UPS	Switching time ≤15ms
Power	0-80% in 45 min 2,200W Max.(Pair with B210 for 2,400W Max.)
DC Input	
Interface	2-pin Aviation Socket
Power	1,200W Max.
Current	21A Max.
Voltage	11V to 60VDC
Battery Expansion Port	
Voltage	44.8V to 57.6VDC
Input Current	60A Max.



13. Button Operation Instructions

Operation	Function	Description
Press the AC Power Button	Turn on / off the AC output	/
Press the DC power button	Turn on / off the cigarette lighter port and RV port output	/
Press the USB Power Button	Turn on / off the USB output	/
Press the AC and DC Power Buttons simultaneously and hold for more than 2 seconds till the output frequency flashes	Enter / exit the Setting Mode	In the Setting Mode, the icons for the currently enabled functions remain lit, except for the flashing output frequency icon. If you do not perform any operation in 1 minute, the AC240 will automatically exit the Setting Mode, and no changes will be saved.
Press the DC Power Button in the Setting Mode	Navigate through the setting items	The flashing setting item is selected and editable. In the Setting Mode, the corresponding codes will be displayed on the left side: P01: Output Frequency P03: Charging Mode P04: Power Lifting Mode P05: ECO Mode P06: Bluetooth P07: WiFi
Press the AC Power Button when the setting item is flashing	Enable or disable the selected function.	/
Press and hold the DC Power Button in the Setting Mode	Switch the status page	You can view relevant information on the status page.  : Serial Number  : Error code  : Historical faults  : Version

14. Troubleshooting

In the Setting Mode, press and hold the DC power button to switch the status page until the  icon and the error code appear simultaneously on the screen. Please refer to the table below for helpful guidance.

Error Code	Alarm Icon	Description	Troubleshooting
E001		Inverter overload	Check if the power consumption of your devices is too high. Reduce the load if necessary.
E002		Inverter overtemperature protection, AC output off	Wait for about 10 minutes until the unit cools down, then turn on the AC output again.
E003		Inverter short circuit	1.Check if the power consumption of your devices is too high. 2.Check if any of your electrical devices are causing a short circuit.
E033		PV overvoltage	Make sure the PV input voltage is within the range of 11V-60VDC.
E039		PV overtemperature	Wait for about 10 minutes until the unit cools down, then re-enable the PV input.
E065		DC output short circuit	1.Check if the power consumption of your devices is too high. 2.Check if any of your electrical devices are causing a short circuit.
E067		DC output overcurrent	Check if the power consumption of your devices is too high. Reduce the load if necessary.
E068		DC output overtemperature	Wait for about 10 minutes until the unit cools down, then restart your devices.
E085		Charging temperature too high	Wait for the unit to cool down before charging.
E086		Charging temperature too low	Make sure the unit is placed in an ambient temperature of 0°C to 40°C (32°F to 104°F).
E087		Discharging temperature too high	Wait for the unit to cool down before discharging.

E088		Discharging temperature too low	Make sure the unit is placed in an ambient temperature of -20°C to 40°C (-4°F to 104°F).
E115		Grid overfrequency	Check if the grid frequency is too high. Contact your local power provider if necessary.
E116		Grid underfrequency	Check if the grid frequency is too low. Contact your local power provider if necessary.
Others	/	/	Please contact BLUETTI support for assistance.

Appx. 1 Estimating Operation Time

To estimate the operation time of the AC240, consider the load you're applying:

Operation time = Battery Capacity (Wh) x DoD x η ÷ (Load Power + AC240 Self-consumption)

Note: DoD refers to the depth of discharge. AC240 works at 95% DoD for longer battery life.

η is the conversion efficiency of the inverter, typically over 85% for AC240.

Please keep in mind that the estimated operation time provided is for reference purposes and may vary based on actual usage conditions. Factors such as low temperature and excessive loads can significantly affect the battery capacity, leading to a reduction in the average operation time.

Appx. 2 FAQ

Q1: How do I know whether my devices will work well with this product?

A: Please evaluate the total constant load of your devices. If it doesn't exceed the Max. output power of AC240 (2400W), you can use this power station to run your devices.

Note: Some devices with built-in motors or compressors may start at 2-4 times the rated power, which can easily overload the AC240.

Q2: Can I use third-party solar panels to charge this product?

A: Yes, you can. However, make sure your solar panels have an open circuit voltage of 11V-60V and are equipped with MC4 connectors. It's also important not to mix different types of solar panels.

Q3: Can it charge and discharge at the same time?

A: Yes. It supports pass-through charging. The AC240 comes with the premium LiFePO₄ battery and proprietary Battery Management System to ensure that it can charge and discharge at the same time.

Q4: Why is the charging power often too low?

A: AC240 has a built-in intelligent BMS that automatically adjusts the charging power in response to the battery temperature and SoC, thus protecting the battery and extending its service life.

For more information, please visit:



@ BLUETTI Support

@ BLUETTI Official



@bluetti_australia



@bluetti.au



@ bluetti_inc



sale-au@bluettipower.com

Customer Service(AU)

Email: sale-au@bluettipower.com

Address: Unit 15, 25 Gibbes Street Chatswood NSW 2067

Customer Service(ZA)

Email: sale-za@bluettipower.com

SHENZHEN POWEROAK NEWENER CO., LTD.

Address: F19, BLD No.1, Kaidaer, Tongsha Rd No.168,

Xili Street, Nanshan, Shenzhen, China

Web: <https://www.bluettipower.com>



P/N: 17.0303.0709-01A1



BLUETTI

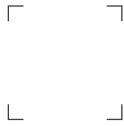

Certificate

Inspector: _____

QC: _____

Just Power On