

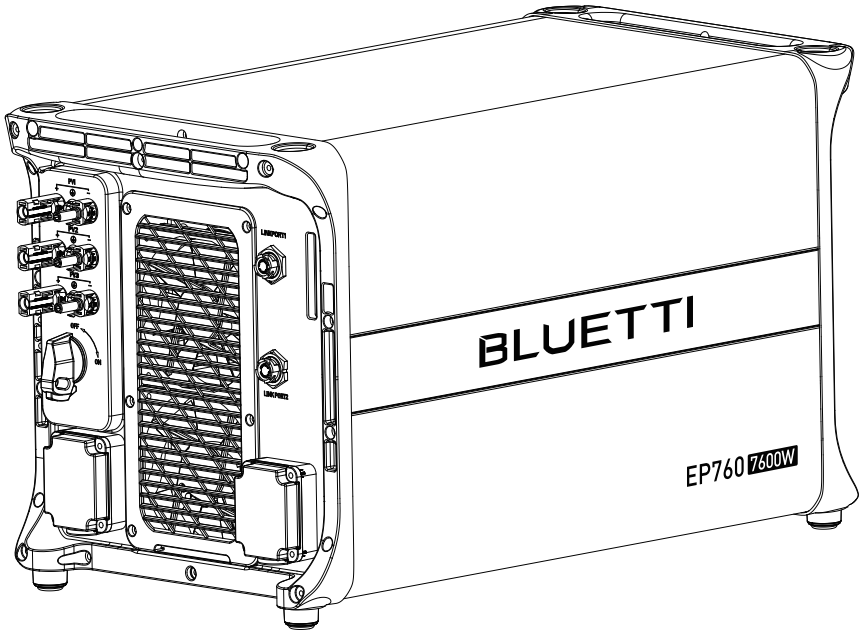
# EP760

# Hybrid Inverter

## User Manual

Please Read This Manual Before Use And Follow Its Guidance.  
Keep This Manual For Future Reference.





## Thank You!

Thank you for making BLUETTI a part of your family.

From the very beginning, BLUETTI has tried to stay true to a sustainable future through green energy storage solutions for both indoor and outdoor use while delivering an exceptional eco-friendly experience for our homes and our world. That's why BLUETTI makes its presence in 100+ countries and is trusted by millions of customers across the globe.

## **Instruction**

**Copyright © 2023 Shenzhen PowerOak Newener Co., Ltd. All rights reserved.**

No part of this document may be reproduced or transmitted in any form or by any means without the prior written consent of Shenzhen PowerOak Newener Co., Ltd.

### **Notice**

BLUETTI's products, services, and features are subject to the agreed-upon terms and conditions during purchase. Please note that some products, services, or features described in this manual may not be available under your purchase contract. Unless otherwise specified in the contract, BLUETTI makes no representations or warranties of any kind, express or implied, with respect to the contents of this manual.

The contents of this manual are subject to change without notice. Please get the latest version from BLUETTI official website.

If you have any questions or concerns about this manual, please contact BLUETTI customer service.

### **Shenzhen PowerOak Newener Co., Ltd.**

19F, Block A, Kaidaer Building, No. 168 Tongsha Road, Nanshan District,  
Shenzhen, Guangdong,  
China

# About the Manual

## Purpose

This user manual describes the installation, electrical connection, commissioning, maintenance and troubleshooting of EP760 Hybrid Inverter. Please read and understand all instructions in this manual before use.

## Target Audience

- Installation, operation, and maintenance technicians
- Owners of EP760 Hybrid Inverter

## Symbol Conventions

This manual uses the following symbols to highlight important information:

	<b>Danger</b> It indicates a hazardous situation which, if not avoided, will result in death or serious injury.
	<b>Warning</b> It indicates a hazardous situation which, if not avoided, could result in death or serious injury.
	<b>Caution</b> It indicates a hazardous situation which, if not avoided, could result in minor or moderate injury.
	<b>Attention</b> It indicates a potentially hazardous situation which, if not avoided, could cause substantial damage to property and the environment.
	<b>Instruction</b> It contains important additional information as well as useful tips for the safe, efficient, and hassle-free operation of the EP760 Hybrid Inverter



# Contents

1	Safety Guideline .....	06
2	EP760 .....	18
2.1	Introduction .....	18
2.2	Working mode .....	19
2.3	Features .....	21
2.4	Inverter Overview .....	22
2.5	Inverter Interface .....	23
2.6	LED Indicator .....	26
2.7	Buzzer Alarm .....	27
2.8	Inverter Cables .....	27
3	B500 Battery .....	28
3.1	Features .....	28
3.2	Battery Overview .....	28
3.3	Battery Interface .....	29
3.4	LED Indicators .....	30
3.5	Battery Cables .....	31
4	IoT Controller .....	32
4.1	Communication Principle .....	32
4.2	Overview .....	32
4.3	Safety Instructions .....	33
4.4	Connection and Operations .....	33
5	System Installation .....	36
5.1	Installation Procedure .....	36
5.2	Installation Preparation .....	37
5.3	Installation Requirements .....	44
5.4	Stacking the EP760 .....	46
5.5	IoT Controller Installation .....	47
5.6	Electrical Connection .....	49
6	System Check .....	64
7	System Maintenance .....	66
8	System Disposal .....	67
9	Specifications .....	67
10	Troubleshooting .....	70
11	FAQs (Frequently Asked Questions) .....	74

# 1. Safety Guideline

## 1.1 Safety Instructions

### 1.1.1. Disclaimer

Read this manual for instructions on the proper use and safety information for the unit. Pay attention to the "Instruction", "Caution", "Warning" and "Danger" symbols in this manual, and follow the instructions carefully to avoid injury or damage.

The Safety Requirements provided herein are for illustrative purposes that include but are not limited to those listed in this manual. Actual operation shall comply with all applicable safety standards. If you have any questions, feel free to contact BLUETTI support or your local BLUETTI dealers.


To ensure a safe and reliable operation, it's crucial to carefully observe and adhere to the following conditions :

- Always operate or store the equipment in the conditions specified in this manual.
- The installation and ambient conditions must comply with the regulations in the relevant international, national or regional standards.
- Avoid unauthorized disassembly, equipment replacement, or modification of software codes.

BLUETTI shall not be liable for damages resulting from the following circumstances:

- Force majeure events such as earthquakes, fires, storms, floods, or mudslides.
- Damages caused by improper handling and installation that do not meet the requirements outlined in the manual.
- Damages resulting from inadequate storage conditions as specified in the manual.
- Hardware or data damage caused by customer negligence, improper operation, or intentional actions.
- System damage caused by third parties or customers.
- Adjustments, changes, or removal of labels in violation of this manual.
- Usage of the product in devices with high-performance UPS requirements, including but not limited to data servers, workstations, medical equipment, and others.

## 1.1.2 General Safety


	<b>Danger</b>
Follow these guidelines for proper operation.	

- Do not install, use and maintain the unit in adverse weather conditions such as lightning, rain, snow, and strong breezes (including but not limited to handling and operating the unit, plugging and unplugging signal connections to outdoor facilities, working at height, outdoor installations, etc.).
- Always turn off the power source before starting any electrical work.
- Do not clean the equipment with water.
- Do not disassemble, modify, tamper with, or repair the equipment on your own.
- Regularly inspect the unit and its accessories for damage.
- Use a tester to check for the presence of dangerous voltage before touching any conductor or terminal.
- If the equipment's shell is cracked during transportation or use, do not use it and contact BLUETTI support or your local BLUETTI dealers.
- Use a dry powder fire extinguisher if the equipment catches fire.
- In case of fire, EVACUATE the building or affected area immediately, activate the closest FIRE ALARM system and CALL your local emergency phone number.
- Use genuine cables and accessories provided by BLUETTI.
- Keep the unit away from heat sources or high temperatures, and do not expose it to direct sunlight.
- Do not store the equipment with flammable liquids, gases, or explosive materials.
- Make sure the place where you are using the equipment is well-ventilated and spacious.
- Do not block or cover the openings of the equipment, as this may cause irreversible damage to it.
- Use the equipment for its intended purpose and avoid stacking objects on top of it during storage or use.
- Do not move the unit during operation as the vibrations and shocks associated with movement may cause damage to the internal hardware.

- Turn off the equipment IMMEDIATELY in case of malfunction, and contact the BLUETTI support team if this manual cannot explain the malfunction adequately to you.
- Do not place the equipment on unstable or inclined surfaces.

Keep away from children and pets.


Comply with applicable laws and regulations.



	<b>Instruction</b>
	<ul style="list-style-type: none"> <li>• The transportation, wiring and maintenance shall comply with all applicable laws, regulations and standards.</li> <li>• User-provided materials and tools required shall meet the requirements specified in applicable laws, regulations and relevant standards.</li> </ul>

### 1.1.3 Personnel Requirements

- The installation, commissioning, and maintenance should only be performed by trained professionals who follow proper safety precautions and operating practices.
- To operate BLUETTI equipment, professionals must possess the necessary qualifications and certifications required by local regulatory authorities for tasks like high-voltage operations, working at heights, and specialized equipment operations.

## 1.2. Installation Safety

	<b>Danger</b>
	<ul style="list-style-type: none"> <li>• Avoid working with live electrical components.</li> <li>• Before installation, double check the equipment for any signs of damage or defects to minimize potential risks.</li> <li>• Make sure that the equipment and all associated switches are in the "OFF" position to prevent electric shock.</li> <li>• Do not touch any terminal while the equipment is running, as it may pose a risk of electric shock.</li> </ul>

	<p style="text-align: center;"><b>Warning</b></p>
	<p style="text-align: center;"><b>Attention</b></p> <p>Handle the equipment and accessories with care during loading, unloading and transportation.</p>

### 1.2.1 General Requirements

- Before starting any work, turn off and isolate all electricity to the property at the main panel.
- Take measures to prevent the electricity from turning back on while working, such as a safety tag and lockout.
- Test the circuit's voltage before proceeding to verify that the course is off.
- After installing the equipment, remove the idle package materials from the site such as cartons, foam, plastic, nylon ties, etc.
- Keep people other than the installation technicians away from the EP760.
- When handling equipment and accessories, pack them in their original packaging or other materials to protect them from impact.
- Seal all the wiring ports with fireproof and water-proof materials to prevent possible electric shock or other risks.
- It's prohibited to alter, damage or cover the marking and nameplate of any part of the EP760.
- Check and make sure all safe guards, including screws and waterproof rings, are in place and properly tightened.
- Keep the EP760 firmly secured to the ground or other solid objects, such as a wall or mounting bracket.
- Use a non-abrasive cloth to clean the equipment and accessories. Do not use water or harsh chemicals.
- Please follow the instructions to install the EP760.

## 1.2.2 Anti-static Requirements

- Wear or use personal protective equipment (PPE) or clothing that is appropriate for the work; this may include items such as safety glasses or goggles, or a face shield (with safety glasses or goggles), hearing protection, dust mask, gloves, anti-static bracelet, safety boots or shoes, or rubber boots.
- If you use an anti-static bracelet for electrical connections, make sure the bracelet is properly grounded.

## 1.2.3 Drilling Requirements

When drilling holes in the wall or on the ground, the following safety measures should be considered.

- Wear goggles and protective gloves at all times.
- Shield and protect the equipment to prevent debris from falling into it and remove all debris after drilling.
- Drill holes on the unit are forbidden, as this may damage the equipment's electro-magnetic shielding performance. The metal shavings may cause short circuits on the circuit board.

## 1.3 Battery Safety

### 1.3.1 Statement

BLUETTI shall not be liable for equipment abnormality component damage, personal injury property loss or other damage caused by the following reasons:

- Failure to promptly charge the battery after installation and system connection, leading to over-discharge and subsequent damage.
- Repeated over-discharging of batteries due to improper maintenance or capacity expansion (e.g., mixing new and used batteries) or prolonged periods without full charging.
- Neglecting to follow the battery maintenance guidelines outlined in the user manual.
- Failure to charge the battery as required during storage, resulting in capacity loss or irreparable damage.
- Improper operation or connection errors causing battery short-circuits, damage, drops, or leaks.
- Usage of the battery in ways not specified in the user manual, including combining it with other batteries, regardless of brand or rated capacity.

- Battery damage due to non-compliance with the battery operating environment or external power supply parameters.

### 1.3.2 General Requirements

- Do not expose the battery to high temperatures or around heat sources, such as sunlight, fire, transformers and heaters. If the battery overheats, it may cause a fire.
- To avoid leakage, overheating or fire, do not disassemble, modify or damage the battery. For example, do not insert foreign objects into the battery or place the battery in water or other liquids.
- If any part of the battery is immersed in water, do not touch the battery to avoid electric shock. Please contact the battery recycling company for handling.
- Do not short-circuit the battery terminals. A short circuit can cause a fire.
- Never use damaged batteries or components. Improper use or misuse of damaged batteries or components can damage your device or injure yourself as a result of battery fluid leakage, fire, overheating, or explosion.
- Do not perform welding or grinding work around the battery to prevent fire caused by sparks or arcs.
- Do not store damaged batteries near undamaged ones, as damaged batteries may leak flammable liquid or gas. Only qualified professional or trained personnel is allowed to approach damaged batteries.
- The fire hazard of lithium-ion battery Hybrid Inverter is high. Before handling batteries, consider the following risks:
  - (a) Battery thermal runaway may produce flammable and harmful gases such as CO and HF. Vapors from burning batteries may irritate eyes, skin and throat.
  - (b) The concentration of flammable gases from battery thermal runaway may lead to deflagration and explosion.
  - (c) The battery electrolyte is flammable, toxic and volatile.
- Avoid contact with spilled liquid or gas if the battery leaks chemicals or odors. Do not approach the battery and contact a professional for disposal. Professionals must wear goggles, rubber gloves, gas masks and protective clothing.
- Electrolyte is corrosive and can cause irritation and chemical burns. If you come into direct contact with battery electrolyte, do the following:
  - (a) Inhalation of Vapors: Evacuate contaminated area, get fresh air immediately, and seek medical attention.
  - (b) Eye Contact: Immediately flush eyes with water for at least 15 minutes, do not rub eyes, and seek medical attention immediately.

(c)Skin Contact: Immediately wash the infected area with soap and water and seek medical attention immediately.

(d)Ingestion: Seek medical attention immediately.

- Use the battery within the temperature range specified in this manual.
- Do not expose the battery to humidity or corrosives, as this may cause the battery to rust, corrode and leak chemicals.
- Do not turn the battery upside down or tilt it.
- Do not ignore warning signs on parts or products made by the manufacturer.
- If the battery exceeds its warranty period, please cease its usage and properly dispose of it according to your local regulations.

### 1.3.3 Installation Requirements

- Do not use batteries with compromised packaging.
- Make sure the battery switch is in the OFF position.
- Tighten the screws securely and conduct regular checks.
- Prevent the positive and negative terminals of the battery from touching each other or any metal objects to avoid heat generation or electrolyte leakage.
- After installing the equipment, remove unused packing materials such as foam, carton, plastic and excess cables from the equipment area.

## Fire Emergency Measures




### Danger

- In case of fire, power off the Hybrid Inverter if it is safe to do so.
- Use carbon dioxide, FM-200, or ABC dry powder fire extinguisher.
- Remind firefighters to avoid contact with high-voltage components to prevent the risk of electric shock.
- Overheating may cause the battery to deform and leak corrosive electrolytes or toxic gas. Keep away from batteries to avoid skin irritation and chemical burns.



## Battery Drop Emergency Measures

Danger	
	<ul style="list-style-type: none"><li>• If the battery pack is dropped, violently impacted or tilted during installation, internal damage may occur. So do not use such battery packs to avoid safety risks such as battery leakage and electric shock.</li><li>• If the dropped battery is not obviously deformed or damaged, and there is no abnormal smell, smoke or fire, please contact a professional to transfer the battery to an open and safe place, and contact BLUETTI support.</li><li>• If the battery is obviously damaged or there is an abnormal smell, smoke or fire, please evacuate immediately, and contact a professional or BLUETTI support. Professionals can use fire extinguishing facilities to extinguish the fire under safety protection.</li></ul>

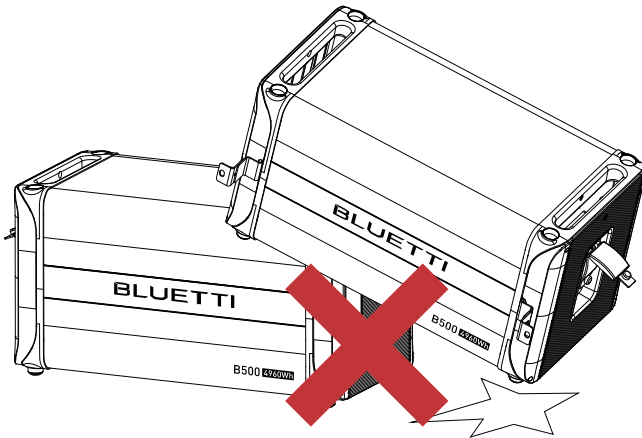


Fig. 1-1

### 1.3.4 Battery Disposal

- Safely and carefully dispose of used batteries by the provisions of local laws and regulations. Avoid treating batteries as regular household waste, as improper disposal can lead to environmental pollution.
- If you find a leaking or damaged battery pack, contact us immediately or an authorized battery recycling partner for expert assistance.
- If the battery pack reaches the end of its lifespan, please contact the battery recycling company for further assistance.
- To maintain battery integrity, do not expose used batteries to high temperatures or direct sunlight.

- Protect used batteries from moisture and corrosive substances to avoid potential hazards.

## 1.4 Electrical Safety

### 1.4.1 General Requirements

- Make sure that all electrical connections comply with your local electrical standards.
- Before connecting an EP760 to your home grid, consult your national or regional electricity authority for guidance.
- User-prepared cables should adhere to local laws and regulations.
- When performing high-voltage operations, use insulated tools for safety.
- Wear anti-static gloves during work and avoid clothing that generates static electricity.


### 1.4.2 Grounding Requirements

- Always make the ground connection first and disconnect it last when installing or removing the equipment.
- Take care not to damage the grounding conductor.
- Before operating the equipment, always confirm that it is securely and reliably grounded.

### 1.4.3 Wiring Requirements

- Keep cables at least 30mm away from the heating devices or heat sources to prevent damage caused by excessive heat.
- Group cables of the same type together to minimize electromagnetic interference. Additionally, ensure that cables of different types should be laid at least 30mm apart without intertwining and crossing.
- Cables used in the PV grid-connected power generation system must be firmly connected, well insulated, and has proper specifications.
- Take necessary measures to protect cables when passing through pipes or holes.
- Safe Construction Practices:
  - (a) All cable installations should be carried out in environments above 0°C to maintain cable flexibility and integrity. Handle the cable with care, especially when working in low temperature environments.
  - (b) If the cable has been stored below 0°C, allow it to acclimate to room temperature for a minimum of 24 hours before installation.

## 1.5 Maintenance Requirements

	<b>Danger</b>
	The equipment generates high voltage during operation, which can cause electric shock leading to severe injury, property damage, or even death. Please strictly follow the safety instructions provided in the user manual and adhere to relevant electrical safety codes.

To ensure your safety while maintaining the EP760, please follow the following steps:

**Step1:** Disconnect the power grid.

**Step2:** Disconnect the battery and solar systems.

**Step3:** Wait at least 30 minutes until the equipment is discharged.

- Follow the anti-static requirements to prevent electric shock and other potential hazards.
- For any maintenance needs, please contact your local authorized service center.
- Place temporary warning signs or erect fences to prevent unauthorized access to the maintenance site.
- To ensure personal safety and proper equipment usage, establish a reliable grounding connection before use.
- Wear personal protective equipment (PPE) during operation. If there is a possibility of personal injury or equipment damage, stop operation immediately, and take appropriate protective measures.
- Use tools correctly to avoid injury or damage to equipment.
- Do not touch energized equipment.
- Do not clean the electrical components inside and outside the cabinet with water.
- Do not stand, lean on or sit on top of the equipment.
- Do not damage the equipment modules.
- When the battery fails, avoid touching the battery and be careful of high temperature.
- Do not disassemble or damage the battery. The released electrolyte is harmful to your skin and eyes. Avoid contact with electrolyte.
- Batteries can cause electric shock and high short-circuit current. When using batteries, please note the following:
  - (a) Remove any metal objects, such as watches and rings, from yourself.
  - (b) Use tools with insulated handles.
  - (c) Wear rubber gloves and boots.

- (d) Avoid the metal objects to short circuit battery terminals.
- (e) Do not place tools or metal parts on top of the battery.
- (f) Disconnect the charging power source before connecting or disconnecting battery terminals.

## 1.6 Transportation Requirements

All components of the EP760 leave the factory in optimum electrical and mechanical state. It's necessary to use original or appropriate packaging to ensure the product safety during transportation. When you receive the product, inspect for any kind of damage and note the damage on the delivery receipt. The shipping company will be responsible for any damage or loss of the product during transportation. If necessary, please contact us for further assistance.

## 1.7 Storage Requirements

- When not using the EP760 for extended periods of time, power it off and remove all electrical connections.
- Charge the EP760 to 40%-60% SoC before storage.
- In order to keep the battery healthy, fully charge and discharge the EP760 every 6 months.
- Make sure the place where to store the EP760 is well ventilated and spacious.
- Do not store the EP760 with flammable liquids, gases, or explosive materials.
- You're strongly recommended to clean the surface frequently with a dry soft cloth.
- Keep away from children and pets.
- Do not stack anything on top of the equipment either in storage or in use.
- Avoid exposing the equipment to rain, humidity or direct sunlight.
- For details of storage temperature, please refer to chapter 10-Specifications.







## 1.8 Handling Requirements

Table 1-1 Recommended Number of People Based on the Weight of Product

Weight	Number of people
<18kg	1
18kg~32kg	2
32kg~55kg	3
>55kg	4 or a cart

## 1.9 Label Description

Table 1-2 Labels and Description

Label	Name	Description
	Discharge delay	There is still residual voltage after the equipment is powered off. Please wait at least 5 minutes until the equipment is discharged.
	Electrical shock warning	The EP760 generates high voltage during operation. The installation, commissioning, and maintenance should only be performed by qualified professionals or trained personnel.
	Warning	Be careful. Hazards may occur during operation.
	Read instruction	Please read the instruction carefully before operating the EP760.
	This side up	It must be transported, handled and stored in the correct orientation. The arrow always faces upwards.
	Weight	The inverter and battery packs are quite heavy and need to be carried by several people.



### Attention

- The symbols on the box contain important information for safe operation.
- The nameplate on the side of the box contains important parameter information related to the product.

## 2. EP760

EP760 is an energy storage photovoltaic grid-connected inverter that can handle photovoltaic input, grid-connected charging, and discharging.

### 2.1 Introduction

The BLUETTI EP760 (hereinafter referred to as the EP760) is a formidable home Hybrid Inverter built to provide a robust power solution for your household and light commercial needs. With a remarkable output of 7,600W, the EP760 offers a substantial power supply that can be further customized by connecting LiFePO4 batteries, allowing you to tailor its capacity according to your specific requirements. Whether you seek uninterrupted power during outages or desire energy independence, the EP760 delivers with its ability to seamlessly power essential appliances and its intelligent power management system that maximizes efficiency. Embrace the reliability and convenience of the BLUETTI EP760 and enjoy uninterrupted power for your home or small business.

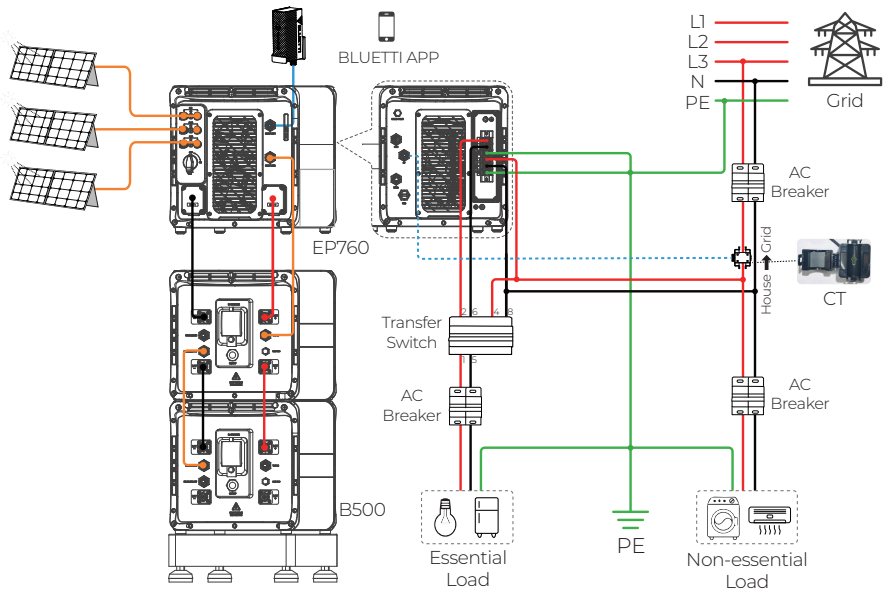


Table 2-1

Item	Description
EP760 Inverter	An energy storage photovoltaic grid-connected inverter to handle photovoltaic input, grid-connected charging, and discharging.
B500 Battery	LiFePO <sub>4</sub> battery pack to power the EP760.
IoT Controller	A component to facilitate seamless near-end communication (Bluetooth) or remote communication (WiFi) with the EP760.
BLUETTI App	An application to monitor and control the EP760.
CT (Current Transformers)	Components to contribute to intelligent operation management within the EP760.
Rapid Shutdown	A component to disconnect the DC input from the solar system and the AC input from the grid.

## 2.2. Working Mode

The EP760 offers four operating modes to accommodate various energy plans. You can choose the one that best suits your home power supply configuration.

### • Mode 1

If there is already a grid-connected PV system, combine it with the EP760 by means of AC coupling. This setup prioritizes PV power for the load, charges the batteries with excess power, and feeds surplus energy back to the grid.

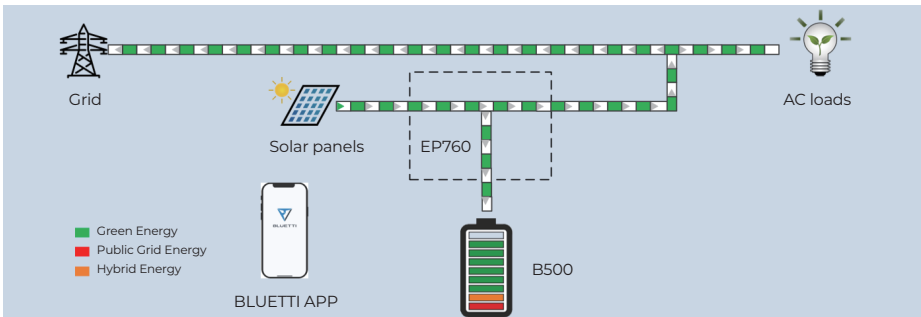


Figure 2-2

• **Mode 2**

In the absence of a PV system, the load is powered by the backup battery. When the battery charge is depleted, the system automatically switches to grid power to continue supplying the load.

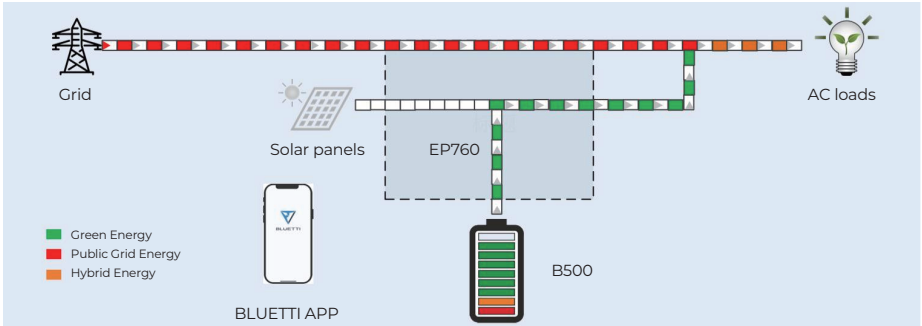


Figure 2-3

• **Mode 3**

If the grid is disconnected, the PV and backup batteries work together to provide power to the load.

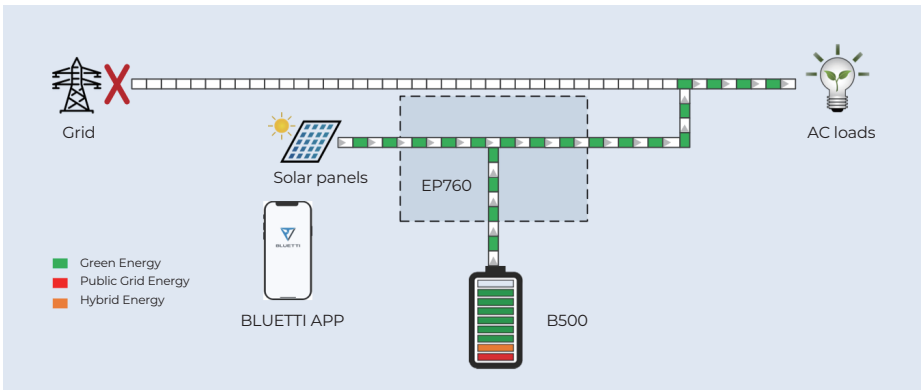


Figure 2-4



## • Mode 4

The batteries are charged from the grid, and the BLUETTI App gives you the flexibility to set the charging time and power to suit your needs.

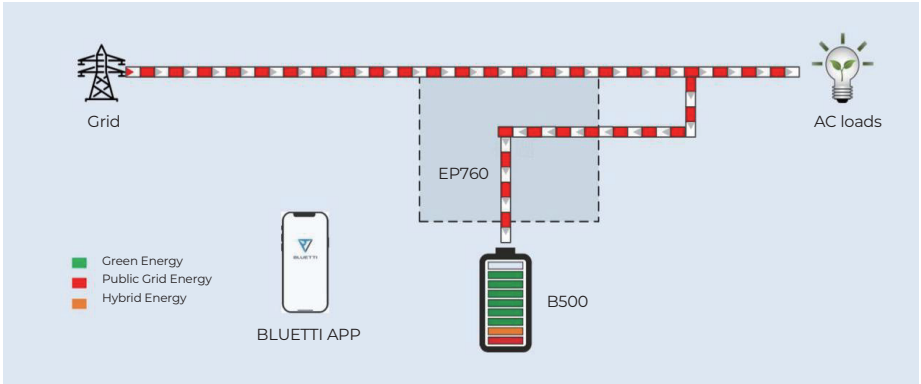


Figure 2-5

## 2.3 Features

**Solar Energy Optimization:** Triple MPPT charge controllers to maximize solar input, while storing solar energy in LiFePO<sub>4</sub> batteries. The EP760 can also work with grid-connected PV systems to make the most of renewable energy.

**Grid-Connected Flexibility:** The inverter allows for grid charging and seamless backup power during outages. It also enables grid power to bypass it to supply home appliances directly.

**Battery expansion:** The EP760 supports 2-4 battery packs (B500) to expand the total capacity.

**App Control & Monitoring:** With WiFi or Bluetooth connection, you can check the system operation anytime and anywhere.

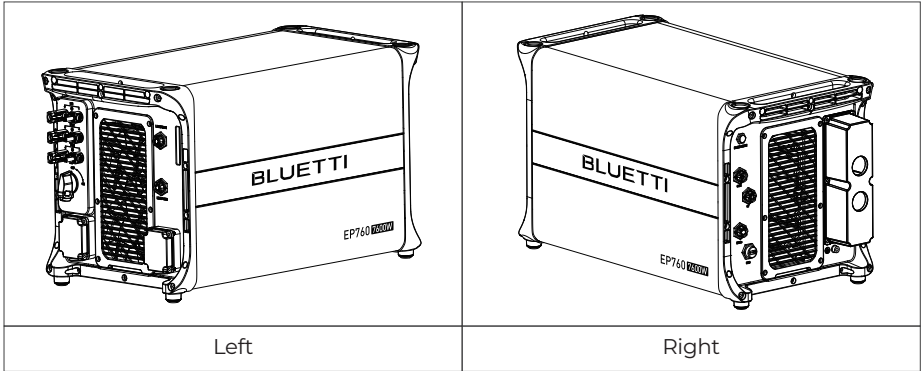
**Enhanced Connectivity:** The EP760 offers a range of interfaces for connecting external devices. Monitor energy usage with the CT interface, integrate with smart meters using the COM interface, and ensure compatibility with diesel generators through the DRMs interface.

**Seamless Device Integration:** The EP760 is designed with I/O ports that enable effortless connection with external devices, ensuring smooth system management and connectivity.

## 2.4 Inverter Overview

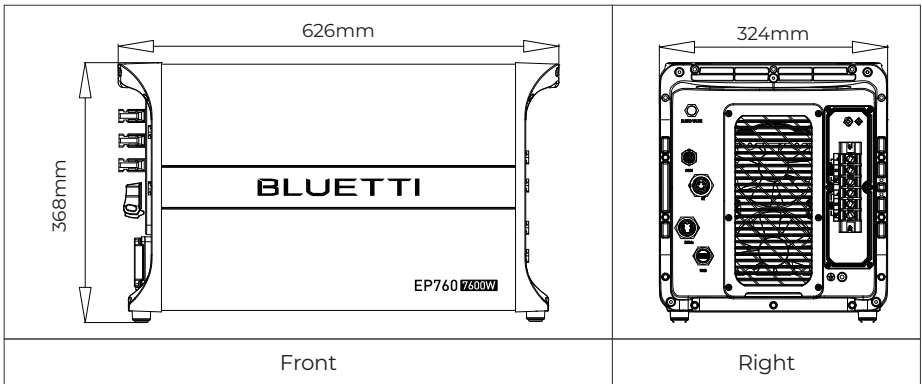
### 2.4.1. EP760 Inverter Appearance

Table 2-1



### 2.4.2 EP760 Inverter Dimensions

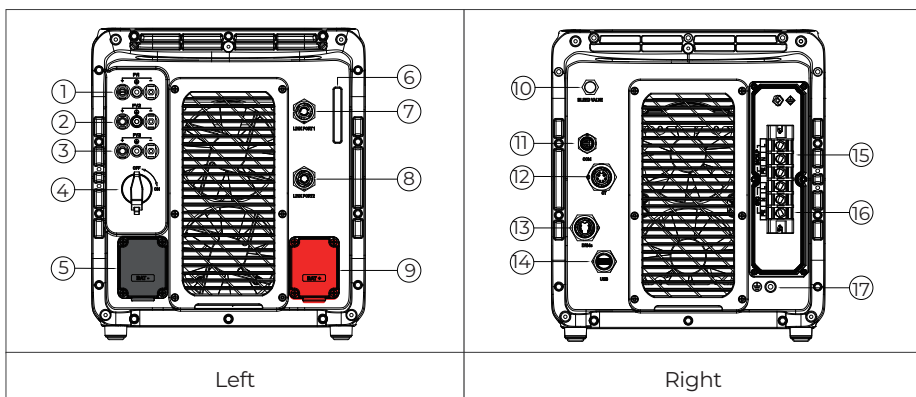
Table 2-2 (Unit:mm)



## 2.5. Inverter Interface

### 2.5.1.EP760 Interface

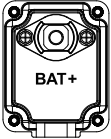

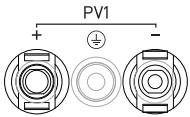
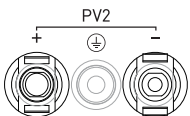
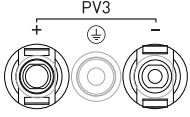
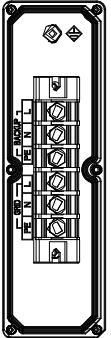
Table 2-3




No.	Name	Decisive Voltage Classification	No.	Name	Decisive Voltage Classification
1	PV Input 1	DVC-C	10	BLEED VALVE	Not applicable
2	PV Input 2	DVC-C	11	COM Port (Meter Port)	DVC-A
3	PV Input 3	DVC-C	12	CT Port	DVC-A
4	DC Switch	Not applicable	13	DRMs Port (Generator)	DVC-A
5	BAT- Terminal	DVC-C	14	USB Port	DVC-A
6	LED Indicator	Not applicable	15	BACKUP Terminal	DVC-C
7	LINK PORT 1	DVC-A	16	GRID Terminal	DVC-C
8	LINK PORT 2	DVC-A	17	GND Terminal (Grounding)	Not applicable
9	BAT+ Terminal	DVC-C			

## 2.5.2 Interface Description

Table 2-4

Terminal	Description	Type of Cable Required	Cable specification	
	BAT+: to the battery BAT+ terminal	Battery expansion cable (Positive)		
	BAT-: to the battery BAT- terminal	Battery expansion cable (Negative)		
	PV1+: to the positive terminal of solar panel PV1-: to the negative terminal of solar panel PV1 PE: PV1 grounding	Outdoor multi-core copper cable (Optional)	Conductor cross-sectional area: 2.5mm <sup>2</sup>	
	PV2+: to the positive terminal of solar panel PV2-: to the negative terminal of solar panel PV2 PE: PV2 grounding	Outdoor multi-core copper cable (Optional)	Conductor cross-sectional area: 2.5mm <sup>2</sup>	
	PV3+: to the positive terminal of solar panel PV3-: to the negative terminal of solar panel PV3 PE: PV3 grounding	Outdoor multi-core copper cable (Optional)	Conductor cross-sectional area: 2.5mm <sup>2</sup>	
	Load (BACKUP)	L	AC copper cable (Optional)	Conductor cross-sectional area: 6mm <sup>2</sup>
		N		
		PE		
	Grid (GRID)	L	AC copper cable (Optional)	Conductor cross-sectional area: 10mm <sup>2</sup>
		N		
		PE		

### 2.5.3 USB

	<b>Warning</b>
	Only for USB drive access, not for USB charging.

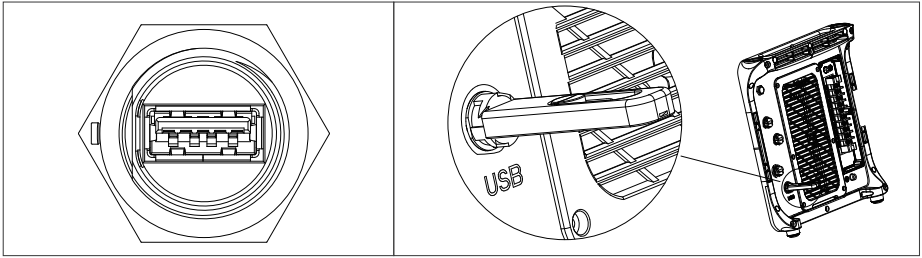


Fig. 2-6

The port is used for EP760 inverter firmware upgrade.

The USB drive should be formatted as FAT32 with no more than 32G in size.

### 2.5.4 DRM Port

The inverter supports DRM0

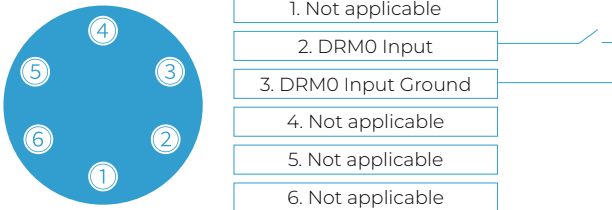


Table 2-5

PIN	Category	Definition	Specifications
1	EXT OUT	I/O output	Not applicable
2	EXT IN	DRM0 Input	Turn on S0 and the inverter shuts down. Turn off S0 and the inverter is back to on-grid.
3	INS GND	DRM0 Output Ground	
4	GEN NO	Single-pole & double-throw relay normally open output	External DC input limit: 30VDC/3A. (For generator input)
5	GEN NC	Single-pole & double-throw relay normally closed output	
6	GEN COM	Single-pole & double-throw relay common terminal	

### 2.5.5. LINK PORT 1 & LINK PORT 2

Table 2-6

Interface	Function	Note
Link Port 1	Connect the IoT controller	Refer to Fig. 6-7 for details.
Link Port 2	Connect the battery pack	

### 2.5.6. CT Port

Table 2-7

PIN	Definition	Description	Note
L	CT-L1+ (Red)	CT output positive terminal	Connect to the Phase L CT in the grid.
N	CT-L1- (Black)	CT output negative terminal	

### 2.5.7. COM Port

Table 2-8

RS485 Meter Communication Port	Function	Wiring
A (1) (L)	A: RS485 differential signal +	Connect to meter A2
B (2) (N)	B: RS485 differential signal -	Connect to meter B2

## 2.6 LED Indicator

Table 2-9

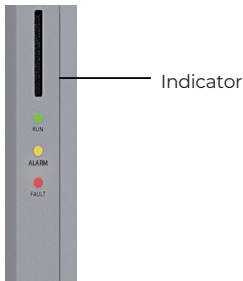


Fig. 3-2

Situation	Run	Alarm	Fault
No alarm and fault	ON	/	/
Alarm	ON	ON	/
Fault	/	/	ON
Alarm and fault	/	ON	ON

## 2.7 Buzzer Alarm

When a fault occurs, the buzzer emits a series of 5 beeps. Each time lasts for 2 seconds with a 1-second interval between each beep.

Note: The buzzer alarm can be turned off in the BLUETTI App.

Table 2-10 Fault Code

Fault Code	Description	Solution
5.	Hardware BUS overvoltage	Turn off the inverter and wait 30 minutes to restart it. If the symptom persists, please contact the BLUETTI support team.
6.	Hardware BUS2 overvoltage	
7.	Hardware battery overvoltage	
8.	Hardware inverter overcurrent	
10.	Hardware LLC1 current overcurrent input	
26.	Hardware PV1 fault	Please contact the BLUETTI support team.
27.	Hardware PV2 fault	Please contact the BLUETTI support team.
28.	Hardware PV3 fault	Please contact the BLUETTI support team.
34.	Hardware overcurrent input	Please contact the BLUETTI support team.

## 2.8 Inverter Cables

Table 2-11 Inverter Cables

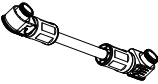
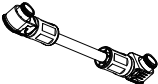


Picture	Description	Interface (connect to)
	Red battery power cable (Positive)	BAT+
	Black battery power cable (Negative)	BAT-
	CT communication cable (4m)	CT port

Table 2-12 Optional Inverter Cables

Picture	Description	Interface (connect to)
	COM communication cable (4m)	COM port

### 3. B500 Battery

#### 3.1 Features

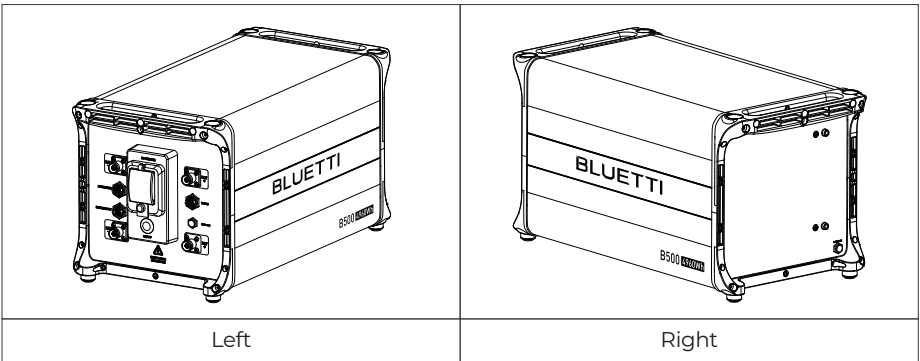
The B500 battery is designed for residential and light commercial use. Single B500 battery pack has a capacity of 4.96kWh. BLUETTI EP760 supports 4 \*B500 units for a whopping 19.84kWh, enough to power a house for several days.

The B500 comes with a reliable battery management system (BMS) with a multi-stage architecture that provides real-time detection of the battery pack's voltage, current and temperature, protecting the system from overvoltage, under-voltage, overcurrent, overtemperature and undertemperature. At the same time, the redundancy design provides unprecedented safety and stability for the B500 battery.

#### 3.2 Battery Overview

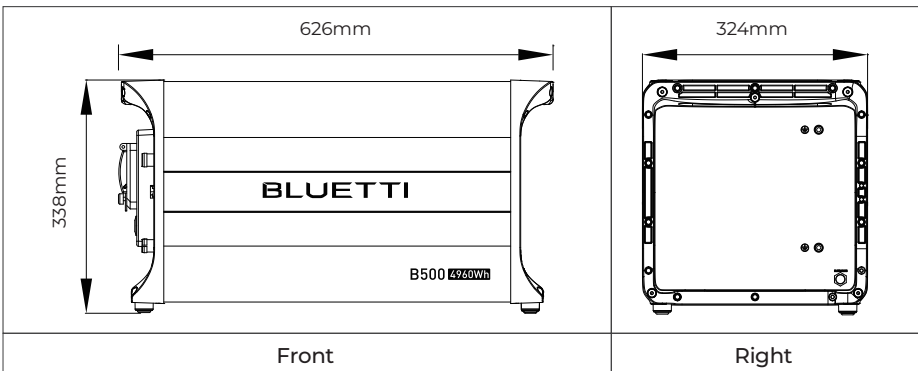
##### 3.2.1 B500 Appearance

Table 3-1



##### 3.2.2 Dimensions

Table 3-2 (Unit: mm)

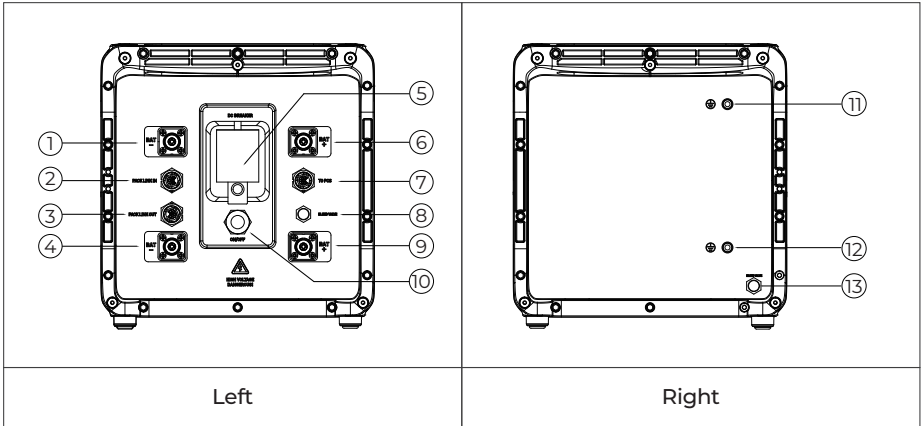




### 3.3 Battery Interface

#### 3.3.1. B500 Interface

Table 3-2



No.	Name	Decisive Voltage Classification	No.	Name	Decisive Voltage Classification
1	BAT- terminal 1	DVC-C	8	Bleed valve 1	Not applicable
2	Pack link-in	DVC-A	9	BAT+ terminal 2	DVC-C
3	Pack link-out	DVC-A	10	Power button	Not applicable
4	BAT- terminal 2	DVC-C	11	Grounding port 1	Not applicable
5	Main switch	Not applicable	12	Grounding port 2	Not applicable
6	BAT+ terminal 1	DVC-C	13	Bleed valve 2	Not applicable
7	Inverter signal port (TO Pcs)	DVC-A			

### 3.3.2. Interface Description

Table 3-4

Interface	Description
⑦ Inverter signal port(PCS LINK)	For communication between inverter and battery packs. Connect to the LINK PORT 2 of EP760 inverter via the battery communication cable.
② Battery pack signal input port (PACK LINK IN)	For communication between battery packs. Connect to the battery pack signal output port of the upper battery via the communication cable when multiple B500s are stacked.
③ Battery pack signal output port (PACK LINK OUT)	For communication between battery packs. Connect to the battery pack signal input port of the lower battery via the communication cable when multiple B500s are stacked.
⑨ BAT+ terminal	Connect to the BAT+ terminal of another B500 or EP760 inverter.
④ BAT- terminal	Connect to the BAT- terminal of another B500 or EP760 inverter.


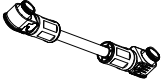
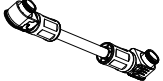
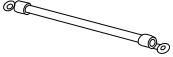
### 3.4 LED Indicators

Table 3-5

Light	Description	Note
OFF	B500 is not started.	Can operate the circuit breaker.
ON	B500 is running.	Can not operate the circuit breaker.
Flash at 0.5Hz	B500 is shutting down.	Can not operate the circuit breaker.
Flash at 1Hz	B500 is not running.	<p>If all indicators are flashing, the battery module is temporarily unavailable and is restoring, please wait patiently.</p> <p>If it lasts for more than 1 hour, please contact an authorized dealer or our company.</p> <p>If a single indicator flashes, the B500 is in a fault condition. Please contact an authorized dealer or our company.</p>

### 3.5 Battery Cables

Table 3-6 Battery Cables

Picture	Description	Interface (connect to)
	Communication Cable	LINK PORT 2 of the inverter
	Red battery expansion cable (Positive)	BAT+ terminal 2
	Black battery expansion cable (Negative)	BAT- terminal 2
	Grounding Cable	Grounding port

## 4. IoT Controller

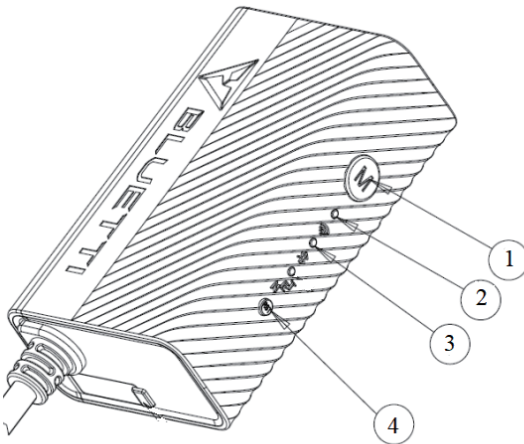
### 4.1. Communication Principle

The IoT controller supports WiFi and Bluetooth dual-mode communication, allowing connectivity between the EP760 and BLUETTI App. Everything about the system, including power generation and consumption, alarms, and operating status, can be uploaded to the BLUETTI server via the WiFi network. By registering the EP760 with your BLUETTI account, you're able to monitor and control this unparalleled power plant anytime and anywhere.

Table 4-1

Communication	Note
WiFi	Standard
Bluetooth	Standard


### 4.2 IoT Controller Overview



- 1.Menu Button.  
To factory reset the controller, press and hold this button for about 5s till all LED indicators flash.
2. WiFi Indicator.  
Flash till the controller connected to WiFi.
3. Bluetooth Indicator.  
Flash till the controller connected to Bluetooth.
- 4.Reboot Button.  
Press to reboot the controller.

### 4.3 Safety Instructions

- The IoT controller is ONLY applicable to BLUETTI products.
- Do not keep the controller near heat sources or in high temperatures.
- Do not store the controller with flammable liquids, gases, or explosive materials.
- The inspection, testing, and maintenance should be performed by qualified personnel.

Warning	
	<ul style="list-style-type: none"><li>• Do not block or cover the openings of the controller. Keep it out of the reach of children.</li><li>• Use dry powder fire extinguisher in case of fire.</li></ul>

### 4.4 Connection and Operations

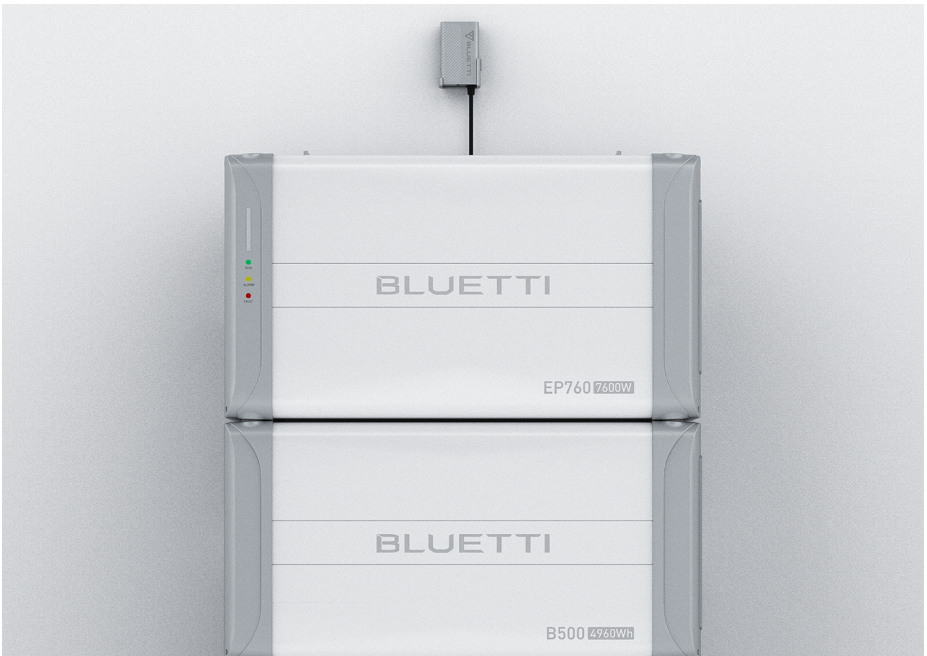


Figure 4-2

**Step1:** Plug the IoT cable into EP760 LINK PORT 1.

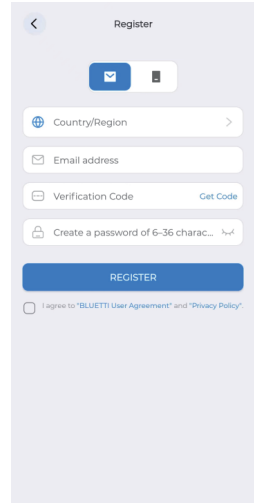
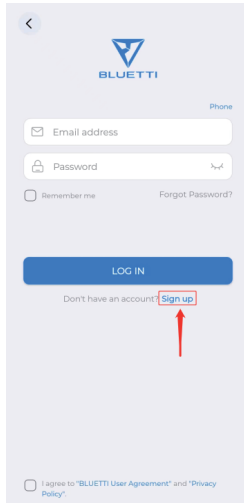
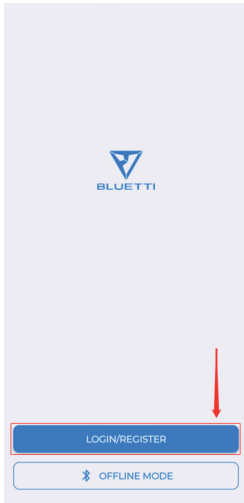
**Step2:** Turn on EP760, and the IoT controller starts up automatically.

**Step3:** Configure the controller in BLUETTI App.

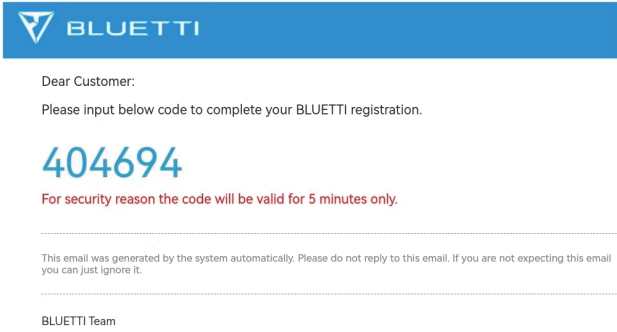
- Scan the QR code below to download the BLUETTI App, or search for “BLUETTI” in the App Store/Google Play.




- The BLUETTI App connects to EP760 via Bluetooth or WiFi. Tap “LOGIN/REGISTER” and “Sign up” to register your BLUETTI account. Fill in the necessary information to continue.



- Check your email for verification code from BLUETTI server, and fill in the code to activate your BLUETTI account.



	<b>Instruction</b>
	<p>Firewall Settings</p> <p>When EP760 is connected to a network with firewall for outbound communication, set permission to access port 18760 as follows.</p>

Action	Source IP	Source Port	Target IP	Target Port
Allow	0.0.0.0/0	All	0.0.0.0/0	18760

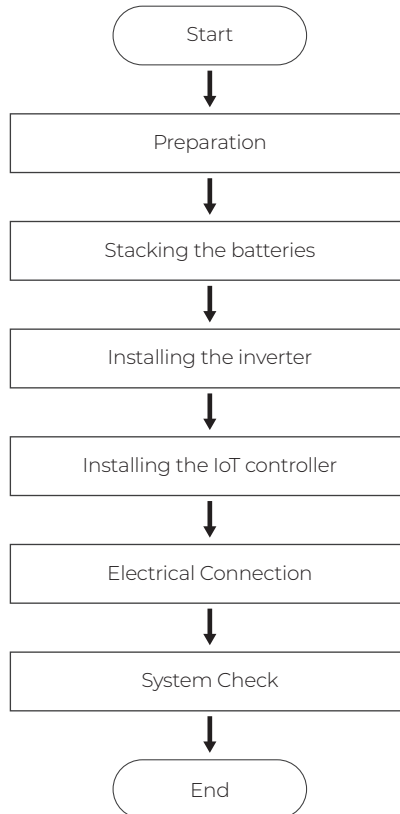
## 5. System Installation



### Danger

Before installation, disconnect all circuit breakers for the battery pack, solar system, and the main switch of the grid to ensure safe operations.

### 5.1 Installation Procedure





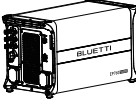
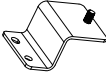




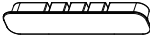

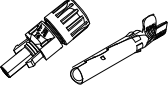
## 5.2. Installation Preparation

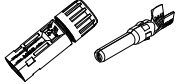








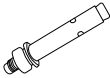
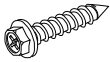


### 5.2.1. Packing Lists






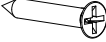



Upon receiving the package, we kindly ask you to carefully inspect and verify the presence of all components and accessories included.

#### EP760 Inverter Packing List

Table 5-1

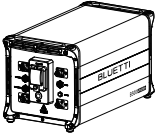

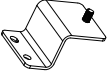






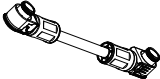
No.	Picture	Description	Qty.
1		EP760 inverter	1
2		Bracket #1	2
3		Bracket #2	2
4		M5 hex nut	2
5		Plastic cover (PV)	1
6		Plastic cover (AC, with label)	1
7		Cord organizer	2
8		AC cable protection case	1
9		Plastic housing (PV+ Input) Metal core (PV+ Input)	3

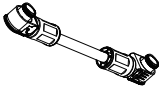
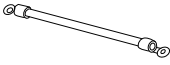
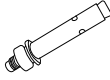
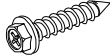


10		Plastic housing (PV- Input) Metal core (PV- Input)	3
11		MC4 wrench	2
12		Black protection cover (BAT- Input) (Pre-installed on EP760 inverter)	1
13		Red protection cover (BAT+ Input) (Pre-installed on EP760 inverter)	1
14		M4*12 screw (8 for BAT+/- protection cover, 6 for AC cable protection case, pre-installed on EP760 inverter)	14
15		M8*12 screw (For battery power cable)	2
16		M6*12 screw (For bracket, pre-installed on EP760 inverter)	2
17		M5*10 screw (4 for fixing device to the bracket, 2 for PV grounding)	6
18		M4*10 screw (For exterior trim)	10
19		M8*60 expansion bolt	2
20		Self-tapping screw, ST8*40	2
21		RNB8-6S OT terminal (AC)	7
22		RNB3.5-5S OT terminal (PV Grounding)	3

23		Red battery power cable (Positive)	1
24		Black battery power cable (Negative)	1
25		IoT Controller	1
26		Mounting bracket (IoT controller)	1
27		Expansion wall plug	2
28		M3 tapping screw (KA3*25)	2
29		CT communication cable (4m)	1
30		M16 3-pin adapter	1
31		CT	1

## B500 Battery Packing List

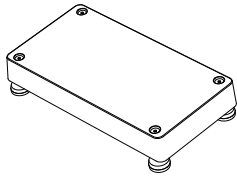
Table 5-2

No.	Picture	Description	Qty.
1		B500 Battery Module	2
2		Bracket #1	2
3		Bracket #2	2
4		M5 hex nut	2
5		Left cover	1
6		Right cover	1
7		M4*8 screw (for fastening covers)	10
8		M5*10 screw (for brackets)	4
9		Communication cable	1
10		Red battery expansion cable (Positive)	1

11		Black battery expansion cable (Negative)	1
12		Grounding cable	1
13		M8*60 expansion bolt (for brackets)	2
14		Self-tapping screw, ST8*40	2
15		M6*12 screw (Grounding cable)	2
16		Spare screw kit	1


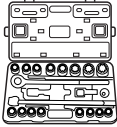
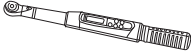

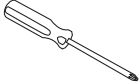

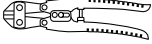
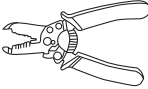
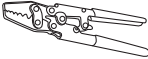
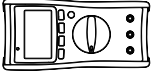
## 5.2.2 Base Packing List



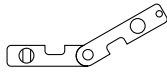
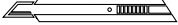







Table 5-3 Base Packing List

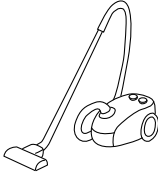
No.	Picture	Description	Quantity
1		Base	1

### 5.2.3 Required Tools

Table 5-4 Required Tools

No.	Picture	Description
1		Electric drill (5/8/10mm)
2		Socket wrench set
3		Torque wrench
4		Flat screwdriver
5		Cross screwdriver (4mm)
6		MC4 spanner
7		Cable cutter
8		Cable stripper
9		Cable Crimper
10		Multimeter (DC voltage $\geq$ 1000VDC)

11		Marker
12		Measuring tape
13		Level ruler
14		Box cutter
15		Heat shrink tubing
16		Heat gun
17		Cable tie
18		Anti-static gloves
19		Protective goggle
20		Mask
21		Safety-toe shoes

22		Vacuum cleaner
----	---	----------------

## 5.3 Installation Requirements

### 5.3.1 Environment Requirements

- Install the EP760 in a well-ventilated and spacious area to ensure good heat dissipation.
- The EP760 has an IP65 rating and can be installed indoors and outdoors. Please note that if you place the system outside the house, use a cabinet to protect it from direct sunlight, as this may cause a degradation in system performance.
- The enclosure and heat sink are very hot while the inverter is working, therefore do NOT install the inverter in places where you might touch inadvertently.
- Keep the EP760 away from flammable liquids, gases, or explosive materials.
- Keep away from children and pets.
- Do not install the EP760 outdoors in salt-affected areas, as the accumulation of salt may corrode the system. Salt-affected areas are those within 500 meters from the coast or susceptible to sea breezes. Salt accumulation is influenced by seawater, sea breeze, precipitation, air humidity, topography and forest cover of adjacent sea areas.
- Do not install the system in low-lying areas where water tends to accumulate. Otherwise, water may leak into the equipment and result in system failure.
- Ambient temperature range:  $-20^{\circ}\text{C} \sim 50^{\circ}\text{C}$
- Relative humidity: 5%~95% (non-condensing)
- Maximum height: 2000m.





### Attention

If the battery pack is dropped, violently impacted or tilted during installation, internal damage may occur. So do not use such battery packs to avoid safety risks such as battery leakage and electric shock.

### 5.3.2 Location Requirements

- The EP760 should be installed on a firm, flat, level base.
- Do not install the system on flammable materials.
- Consider the weight and placement of components to ensure adequate structural support.

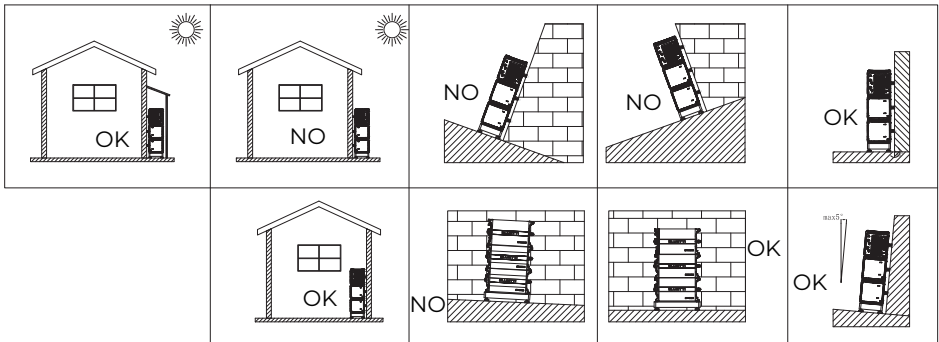


Figure 5-2 Installation Angle

### 5.3.3 Space Requirement



### Danger

Make sure to check for any cables or pipes before drilling into the wall.

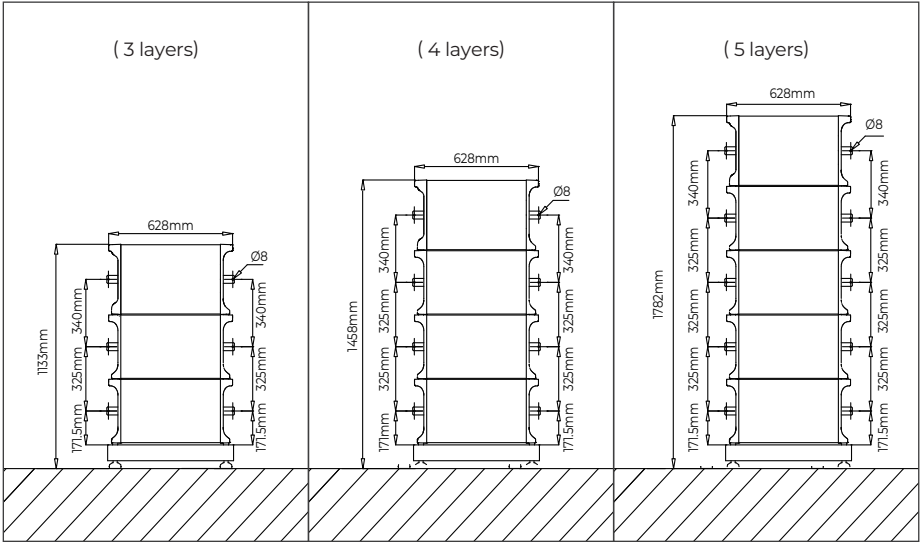


Figure 5-3 (Unit: mm)

## 5.4 Stacking the EP760

**Step 1:** Place the base on the ground and adjust the height of leveling feet so that the base stands stably on the ground. Don't forget to tighten the nuts to secure the leveling feet.



Figure 5-4

**Step 2:** Mark the drilling positions with tape and marker. Drill holes with an electric drill and insert M8 expansion bolts.

**Note:** If you are working with a wooden wall, simply mark the positions and use M8 self-tapping screws to secure the unit directly onto the wall.

**Step 3:** Move the B500 battery pack to the base. Two people are required to transport the B500. Align the bumps on the battery with the notches on the base to secure the battery in place.

**Step 4:** Fix 2 brackets #1 to two sides of B500 with 4 M5\*10 screws. Put the bracket #2 through the compression rivet screw of bracket #1 and M8 expansion bolts. Secure the connection with M8 and M5 nuts.

**Step 5:** Repeat Step 3 and 4 to secure all battery packs.

**Step 6:** Follow the same steps to install the EP760 inverter on top.

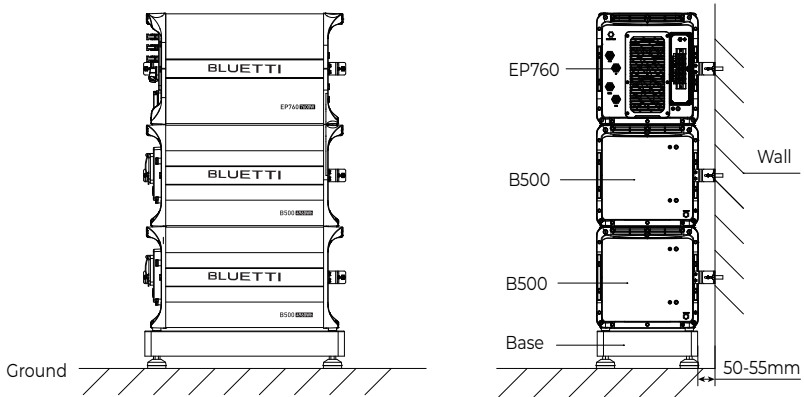


Figure 5-5

## 5.5 IoT Controller Installation



### Danger

Make sure to check for any cables or pipes before drilling into the wall.

To ensure a strong and uninterrupted wireless signal, it is recommended to install the IoT controller in an open space, away from obstructions, and minimize the distance between your home WiFi router and the IoT controller.

Avoid installing the IoT controller near steel-reinforced concrete or metal walls, as these materials can interfere with WiFi and Bluetooth signals.

**Step 1:** Drill 2 pilot holes in the wall. Please refer to the drill position and hole size shown in Figure 5-6-1 and Figure 5-6-2. The depth of hole is 24mm.

**Step 2:** Hammer the expansion wall plug in until it's flush with the wall. See Figure 5-6-3.

**Step 3:** Fix the mounting bracket onto the wall and use the cross screwdriver to fasten 2 self-tapping screws into the wall plugs. See Figure 5-6-4.

**Step 4:** Align the controller's buckle over the U-slot and push the controller downwards until it snaps in place. See Figure 5-6-5 and Figure 5-6-6.

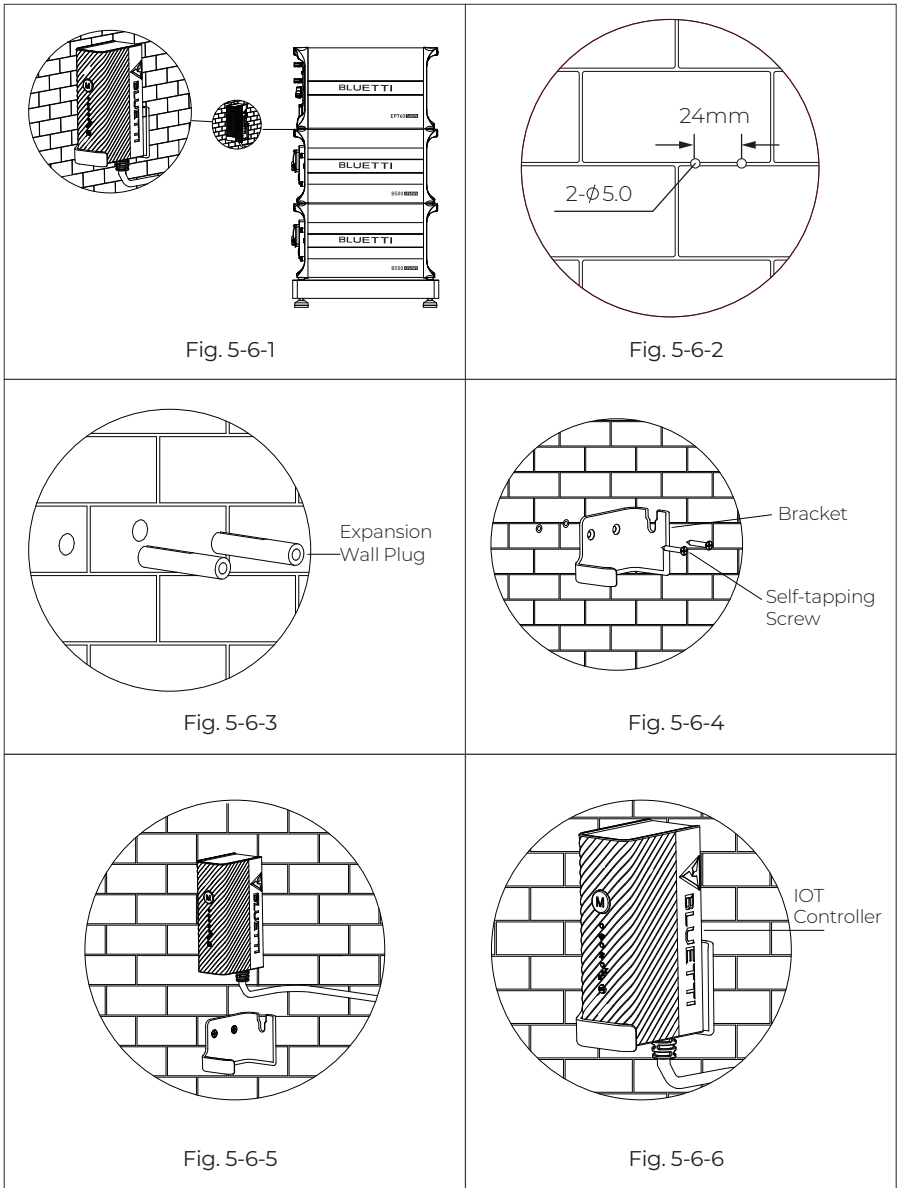




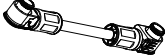
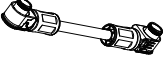
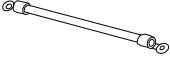

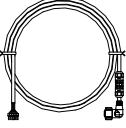


Figure 5-6

## 5.6 Electrical Connection

### 5.6.1 Cables

Table 5-5 Cables

Picture	Cable
	Red battery power cable (Positive)
	Black battery power cable (Negative)
	CT communication cable
	Communication cable
	Red battery expansion cable (Positive)
	Black battery expansion cable (Negative)
	Grounding cable
	Outdoor multi-core copper cable
	COM communication cable

## 5.6.2 Connection Procedure

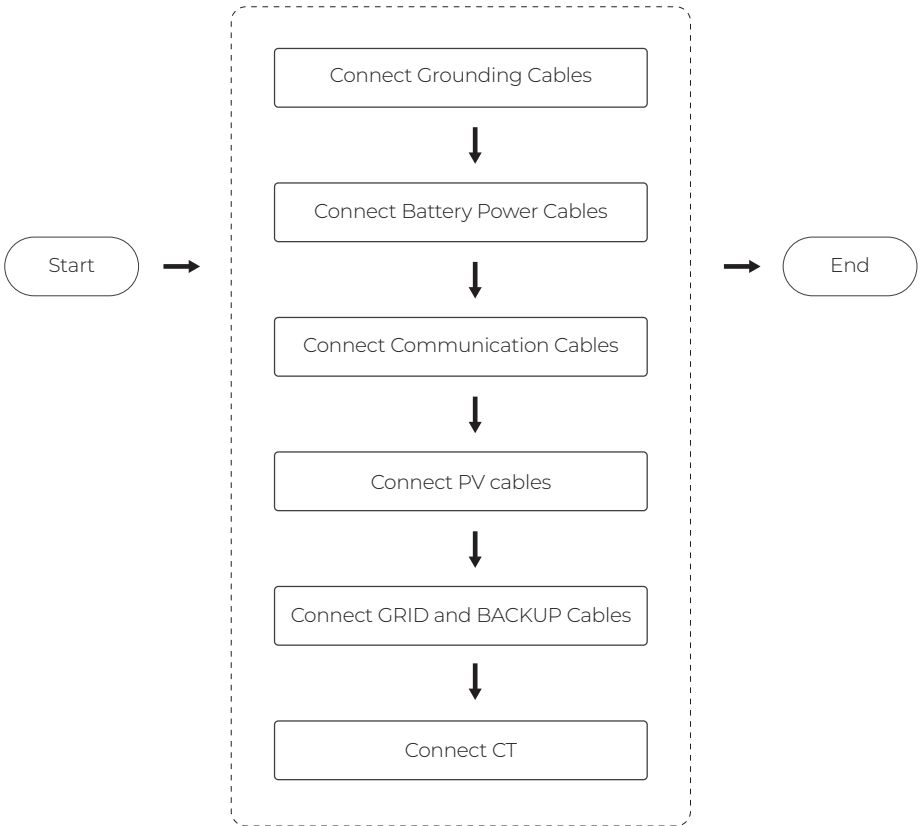


Figure 5-7

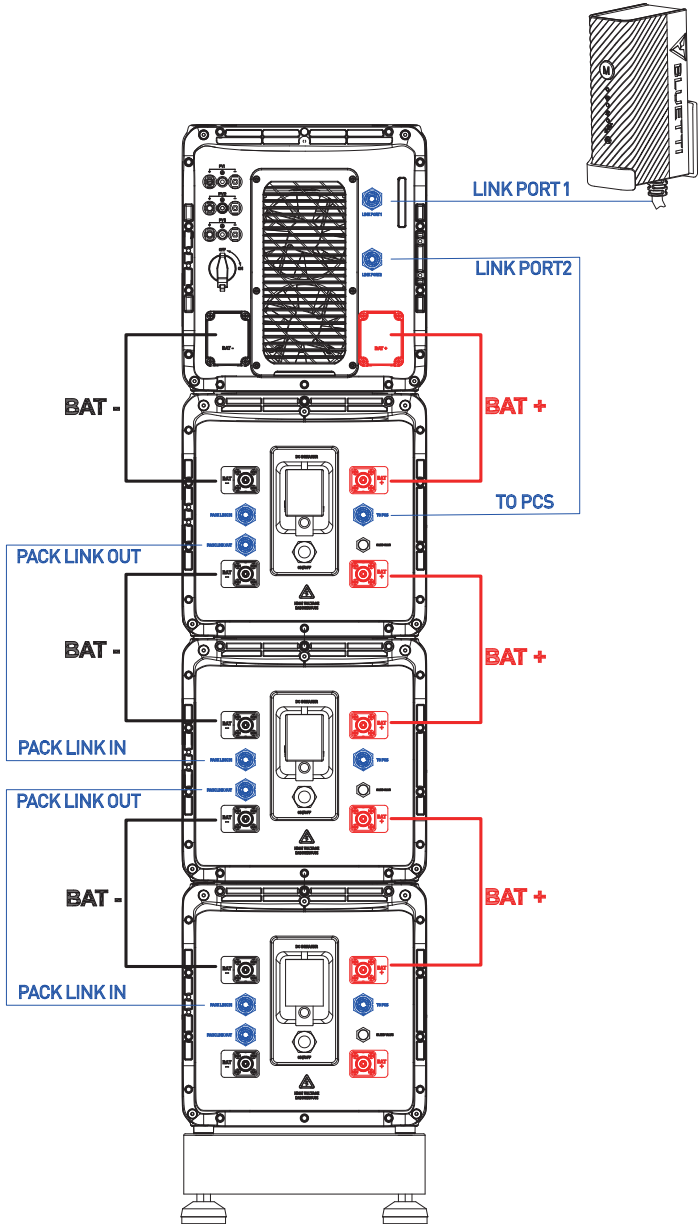


Figure 5-8

### 5.6.3 Connect Battery Power Cables

**Step 1:** Connect two B500 battery packs via the battery expansion cables - black cable for negative terminals, red for positive terminals. See “①” “②” of Figure 5-9-1 and 5-9-2.

**Step 2:** Connect the top B500 to EP760 inverter via the battery power cables - black cable for negative terminals, red for positive terminals. See “③” “④” of Figure 5-9-1 and 5-9-2.

- Fix the black battery power cable to the EP760 inverter BAT- terminal with M8 screws.
- Secure the black protection cover with M4 screws. See Figure 5-9-3.
- Connect the other end of the cable to the B500 BAT- terminal.
- Repeat to connect the red battery power cable. See Figure 5-9-4.

Recommended torque: Less than 6Nm for M8 screws, 1.2Nm for M4 screws.

**Step 3:** Check that the cables are properly connected.

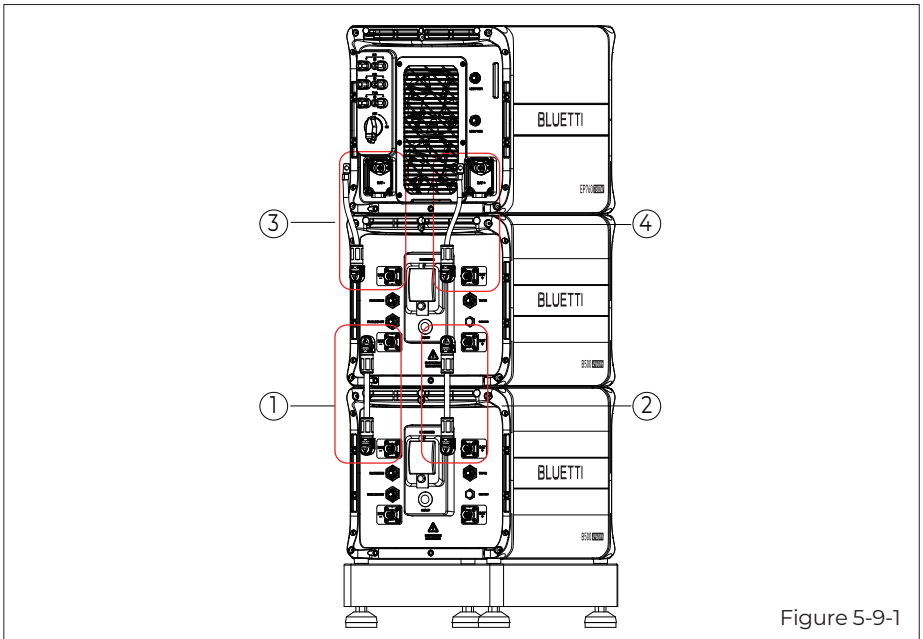


Figure 5-9-1



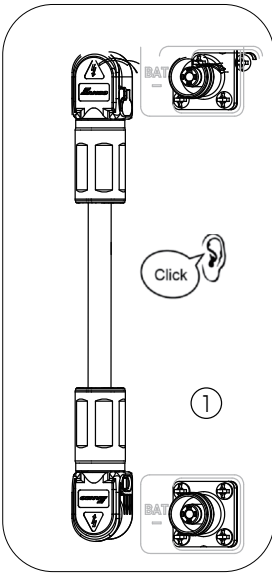


Figure 5-9-2

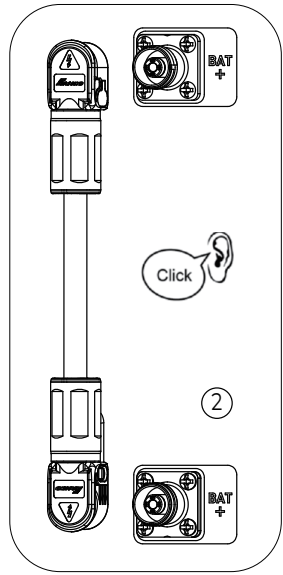


Figure 5-9-2

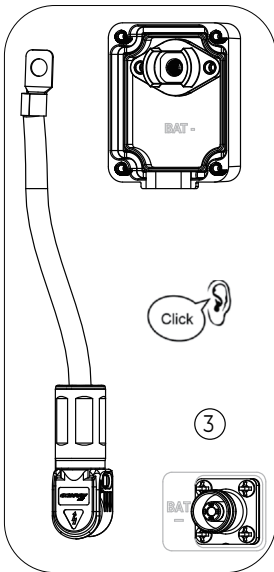


Figure 5-9-2

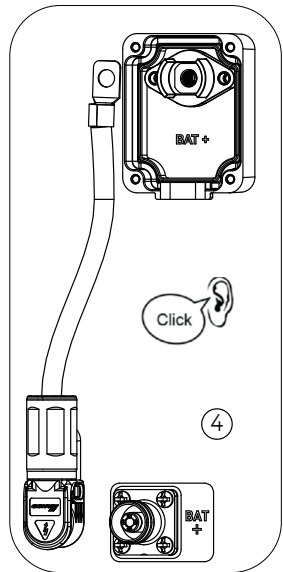


Figure 5-9-2

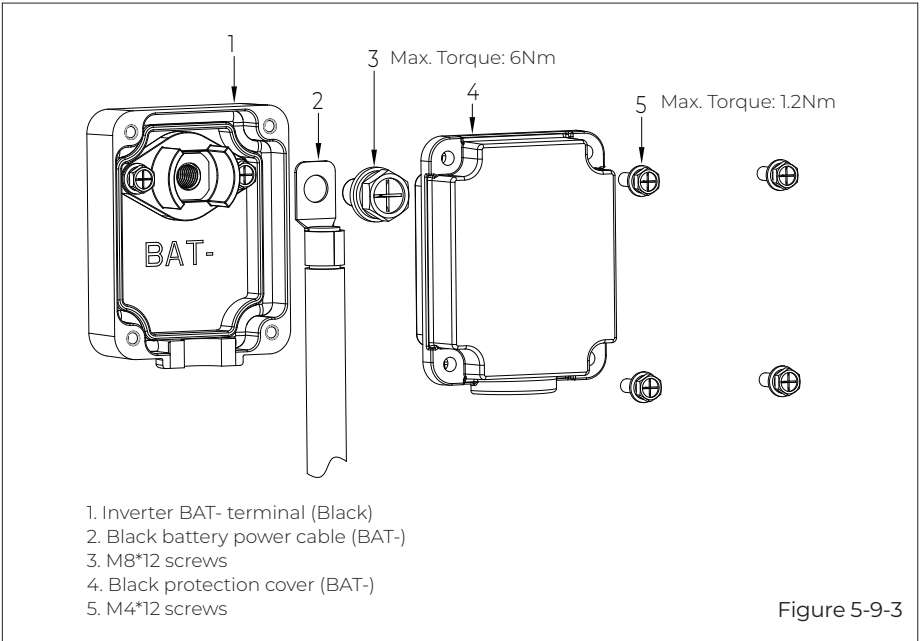


Figure 5-9-3

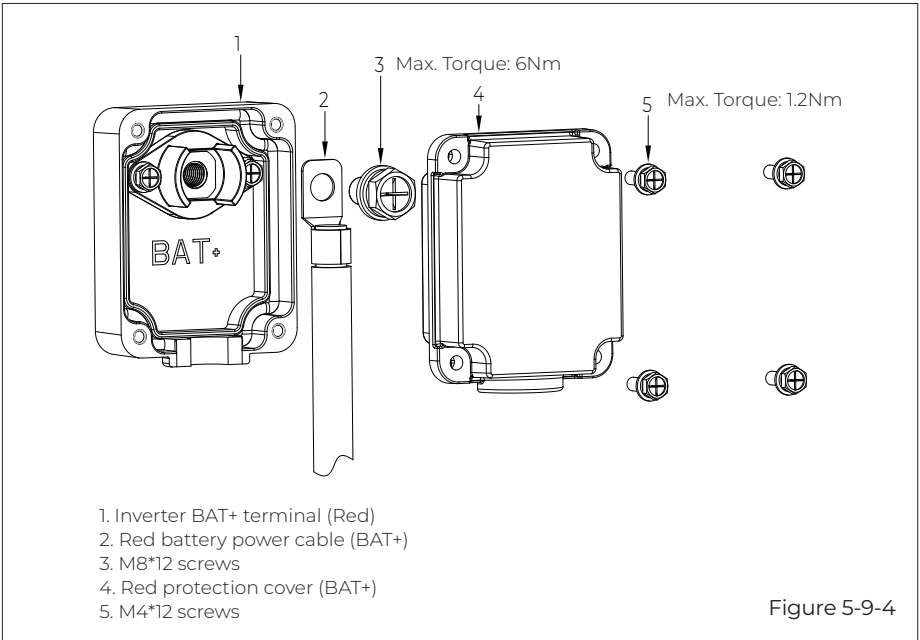


Figure 5-9-4

## 5.6.4 Communication Cable

### Step1:

To achieve communication between two B500 battery packs, a communication cable is required. Plug one end of the cable to the B500 Link-in port, and the other to the upper B500's Link-out port. See Figure 5-10 “①”.

### Step 2:

For communication between EP760 inverter and B500 battery packs, plug one end of the communication cable to the top B500's inverter signal port (PCS LINK), and the other to the LINK PORT 2 of EP760 inverter. See Figure 5-10 “②”.

### Step 3:

Connect the IoT controller to the EP760 inverter. See Figure 5-10 “③”.

**Note:** For how to integrate multiple B500s to the EP760 ESS, please refer to Figure 5-8.

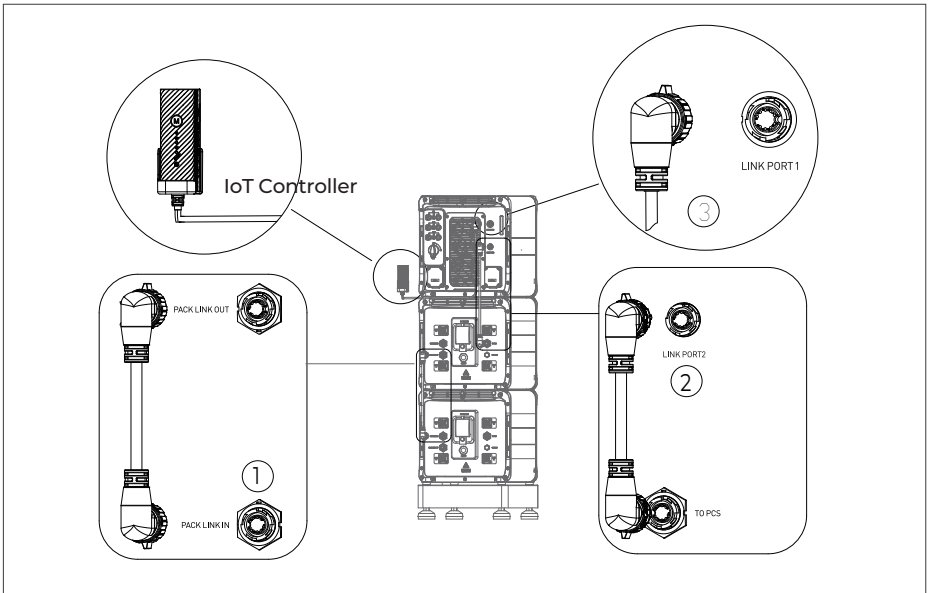


Figure 5-10

## 5.6.5 Connect Grounding Cables



### Danger

The positive and negative terminals of the PV (photovoltaic) system inverter should not be grounded, as it may lead to inverter failure. However, it is important to ground all non-current carrying metal parts, including brackets, distribution boxes, inverter enclosures, battery pack enclosures, and other relevant components.

**Step 1:** It is recommended to use a 12AWG outdoor power cable and RNB3.5-5S OT terminals. Strip the insulation layer of the ground cable with a cable stripper to a proper length. See Fig. 5-11-1.

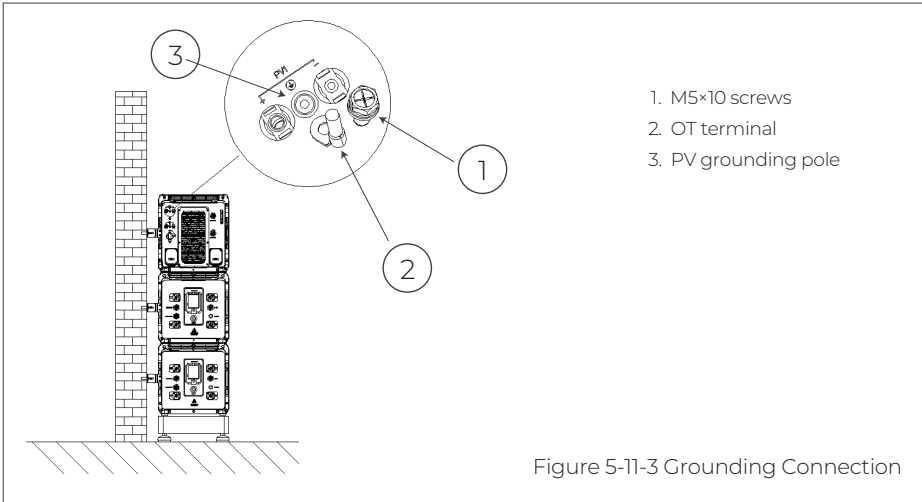
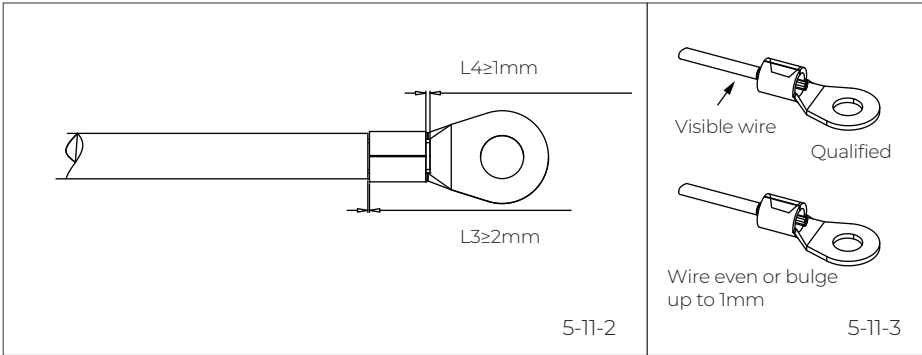
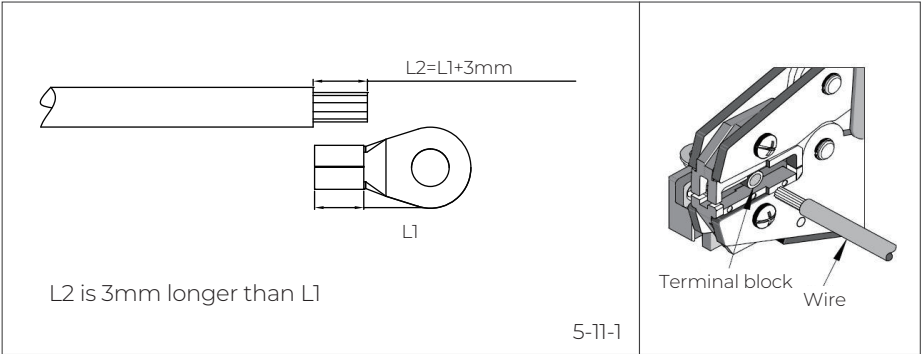
**Step 2:** Insert the exposed core wires into the OT terminal and crimp them with a crimper, as shown in Fig. 5-11-2.

**Step 3:** Fix the OT terminal with M5 screws at the position shown in Fig. 5-11-3.

Recommended torque: 3Nm

**Note:** L3 is the length between the insulation of the cable and the crimped part. L4 is the length between the crimped part and core wires protruding from the crimped part.

The cavity formed after crimping the conductor crimp strip shall wrap the core wires completely. The core wires shall contact the terminal closely.



## 5.6.6. Connect PV Cables



### Attention

Before removing the PV input positive and negative connectors, make sure the DC switch on the EP760 inverter has been set to "OFF".

**Step 1:** It is recommended to use a 2.5mm<sup>2</sup> outdoor power cable. Disconnect the cable connector from the EP760 positive and negative connectors. (You're strongly recommend to distinguish the positive and negative connectors with different colors.)

**Step 2:** Use wire strippers to peel off the insulation layer of the positive and negative power cables. For the specific stripping length, refer to Figure 5-12-1.

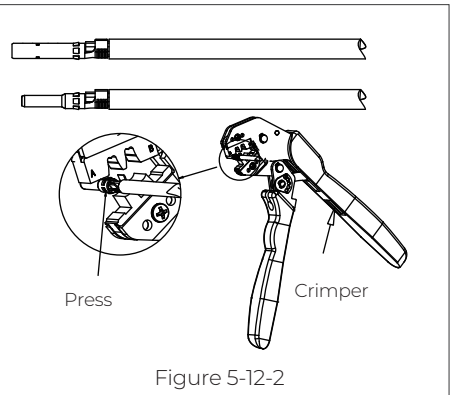
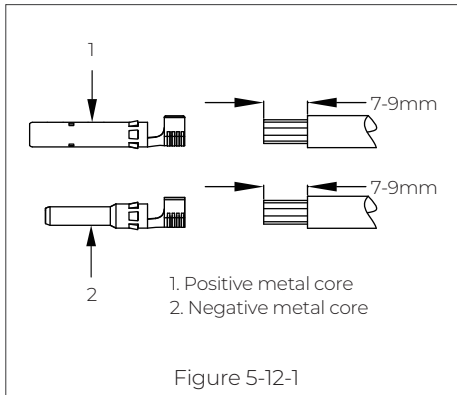
**Step 3:** Insert the positive and negative power cables into the positive and negative metal terminals separately. Crimp them tightly to ensure that the cable can not be pulled out. See Figure 5-12-2.

**Step 4:** Insert the crimped positive and negative power cables through the locking nut and into the corresponding plastic housing until you hear a click, which indicates that the metal core has been snapped into place, and then tighten the locking nut. See Figure 5-12-3 and 5-12-4.

**Step 5:** Use a multimeter to confirm the positive and negative poles. See Figure 5-12-5. Confirm that the voltage is within 150V-500V.

The positive and negative connectors can then be inserted into the PV input of EP760 inverter. See Figure 5-12-6.

If you need to remove the PV positive and negative connectors from the inverter, use a removal crimper to insert the bayonet as shown in Figure 5-12-7, and press down to remove the connectors.



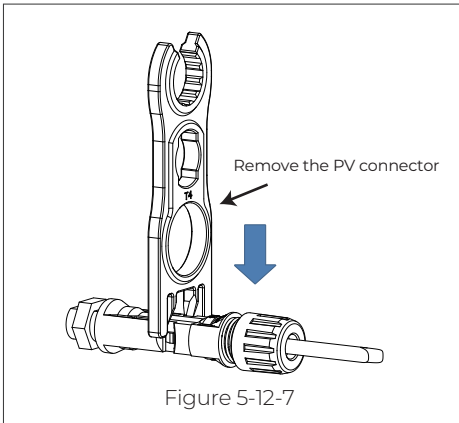
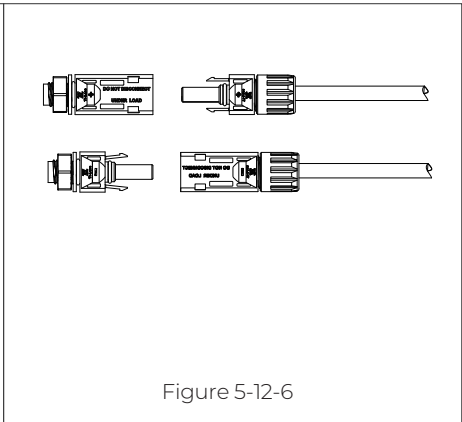
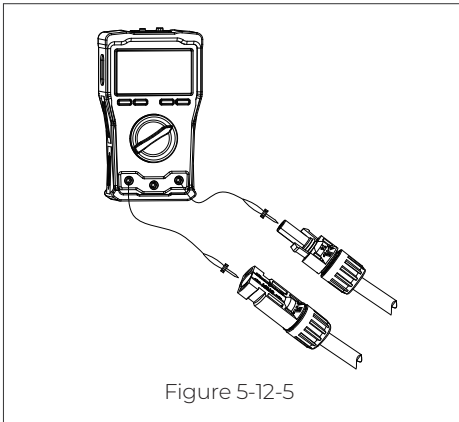
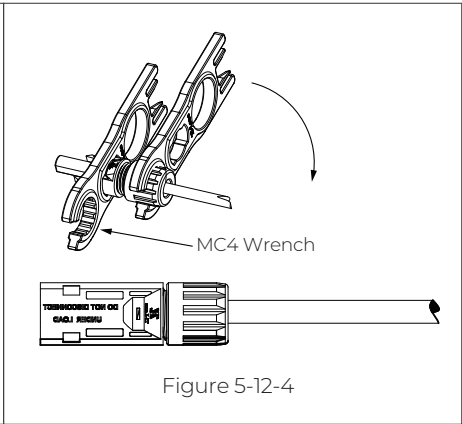
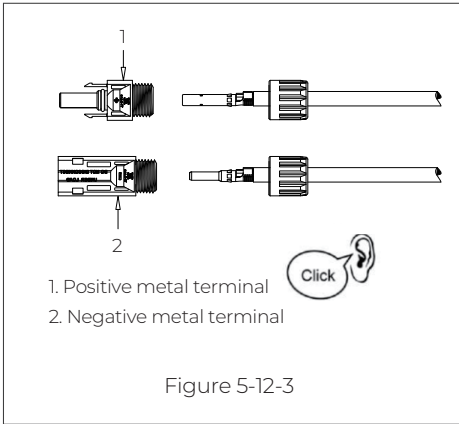


Figure 5-12

### 5.6.7 Connect GRID and BACKUP Cables

**Step 1:** Prepare neutral wire, fire wire, and grounding wire (Blue, brown, yellow-green outdoor multi-core copper cables, and RNB8-6 OT terminals are recommended.).

Strip the cables according to Figure 5-13-1.

**Step 2:** Insert the exposed core wires into the OT terminal and crimp them with a crimper, as shown in Figure 5-13-2. Then, pull to confirm that the terminal crimping is tight.

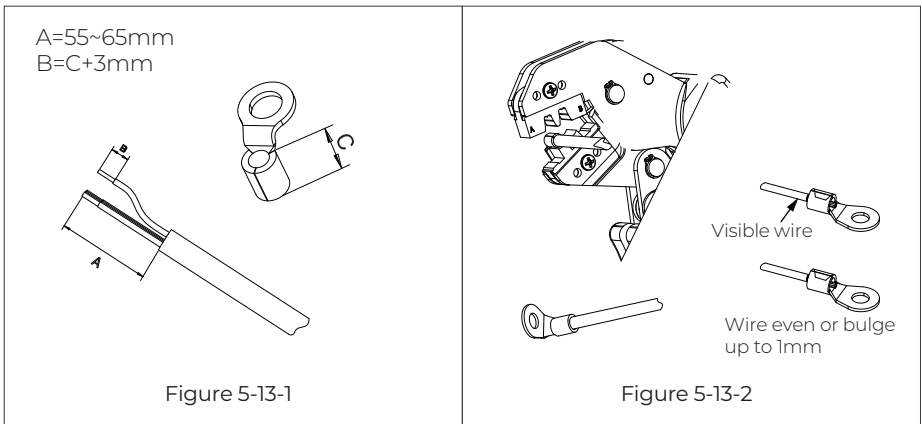
**Step 3:** Fix the terminals to EP760 inverter BACKUP and GRID areas with a cross screwdriver as shown in Figure 5-13-3 and 5-13-4.

**Step 4:** Attach the PG waterproof connector to the AC cable protection case. Tighten the hexagon nut of the connector with a socket tool, as shown in Figure 6-13-5.

**Step 5:** Pass the cable through the PG waterproof connector, as shown in Figure 5-13-6.

**Step 6:** Secure the AC cable protection case to the BACKUP and GRID areas with 6 M4 screws. Tighten the fitting clockwise to the protection case as shown in Figure 5-13-7.

Recommended torque: 1.2Nm





M6 Screws  
Max. Torque: 3.0Nm

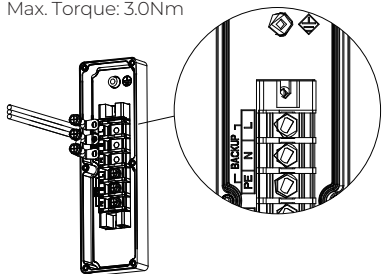


Figure 5-13-3

M6 Screws  
Max. Torque: 3.0Nm

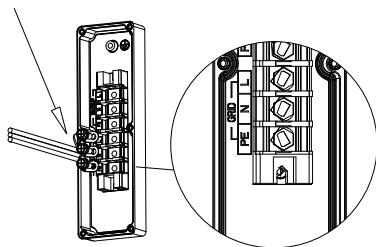
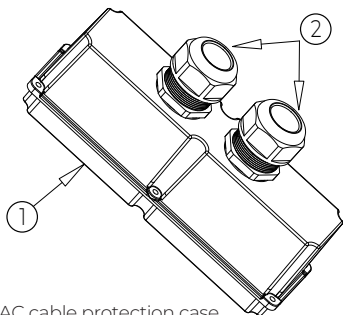
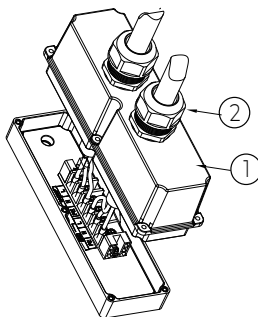


Figure 5-13-4



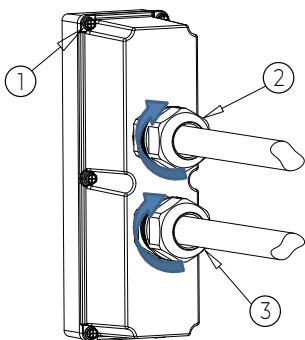
- ① AC cable protection case
- ② PG waterproof connector hexagon nut

Figure 5-13-5



- ① AC cable protection case
- ② PG waterproof connector

Figure 5-13-6



- ① 1M4\*12 screw, (MAX. Torque: 1.2Nm)
- ② BACKUP cables & PG waterproof connector hexagon nut
- ③ GRID cables & PG waterproof connector hexagon nut

Figure 5-13-7

Figure 5-13

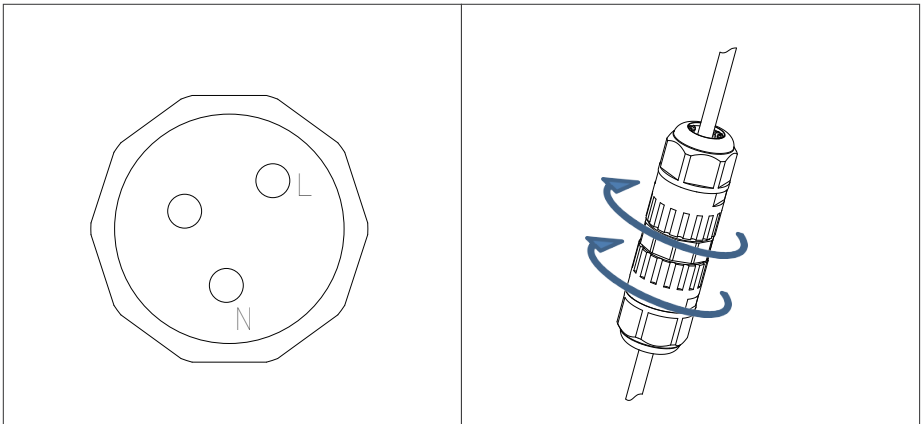
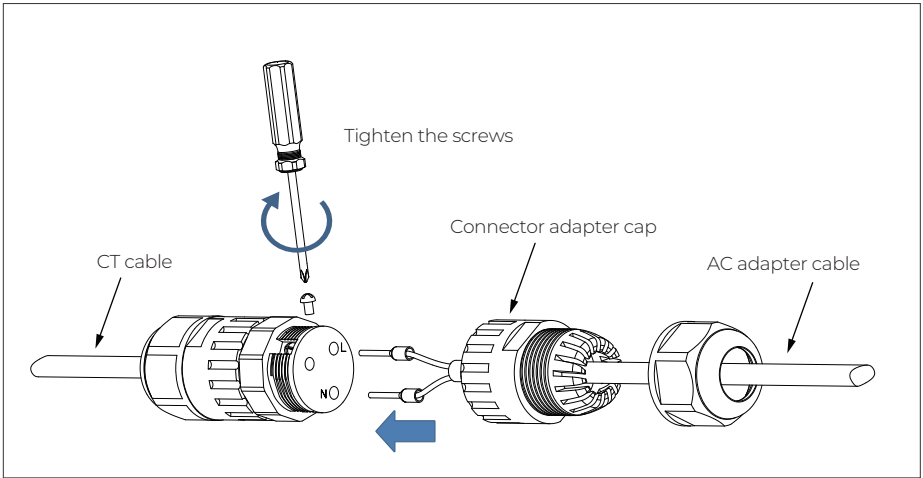
### 5.6.8. CT

**Step 1:** Rotate the CT adapter cap counterclockwise and take it off, and tighten the screws of the connector with a screwdriver.

**Note:** Insert the red signal cable into the L phase, and the black signal cable into the N phase.

**Step 2:** Make sure the cables are secured until they can't be pulled out.

**Step 3:** Tighten the adapter cap and nut clockwise.



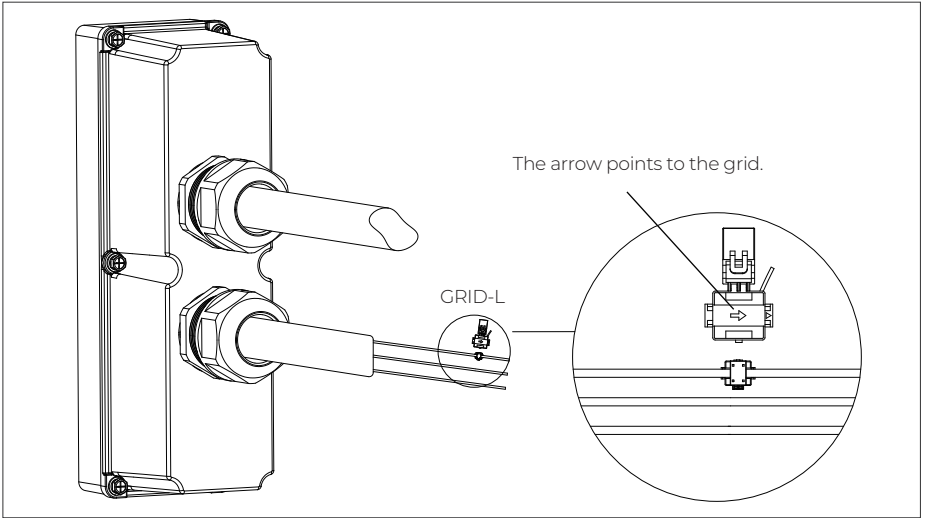


Figure 5-14

Follow the diagram below for the correct CT direction from the grid-tie inverter to the grid.

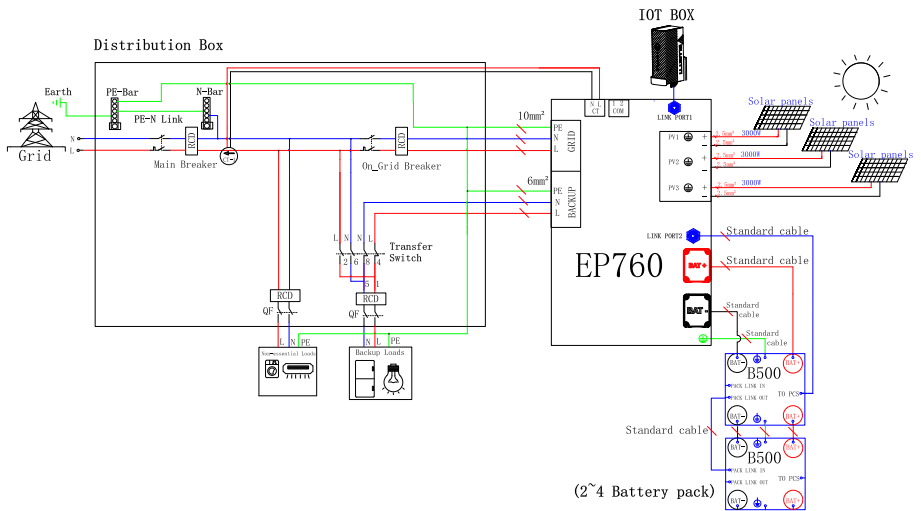


Figure 5-15 DC Coupling

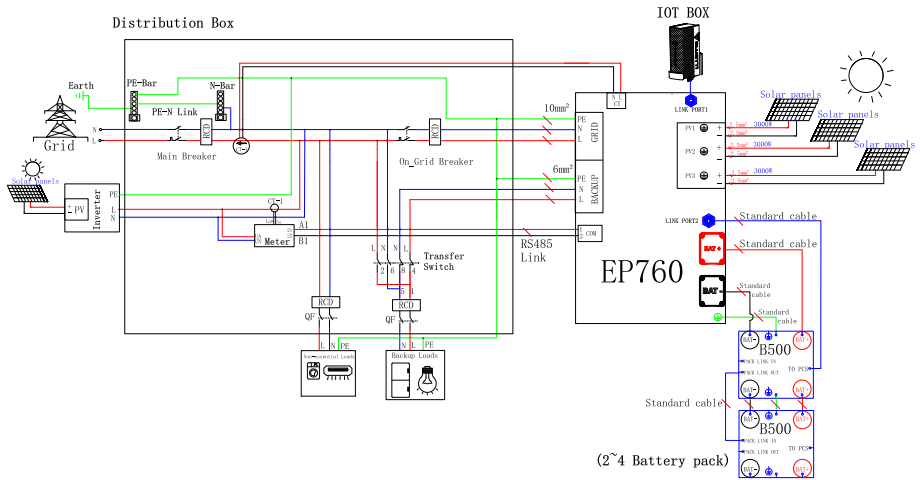


Figure 5-16 AC Coupling

## 6. System Check

### 6.1 Preliminary Check

Check the followings before first use.

- Confirm that all components of the system are installed according to specific requirements.
- Make sure the PV+/PV- and BAT+/BAT- cables are connected with correct polarity and proper voltage.
- Switch off all AC and DC circuit breakers.
- Circuit breakers should be selected according to the requirements of this manual and local regulations.
- Make sure grid and load cables are held firmly in place.
- All safety signs and warning labels shall be firmly attached and clearly visible when needed.

## 6.2 Commissioning

Step 1: Switch on the DC circuit breakers on EP760.

Step 2: Switch on the DC circuit breakers on B500 battery packs. Press and hold the power button on any B500 till the indicator on the button light up green.

Step 3: Wait for about 40 seconds till the inverter indicator keeps steady green.

Step 4: Switch on the AC circuit breakers connected to the inverter GRID terminal.

Step 5: Power on the system via BLUEETTI App. For details, please refer to BLUEETTI App Instructions.

Step 6: Check the output voltage of BACKUP terminal.

Step 7: Switch on the AC circuit breakers connected to the inverter BACKUP terminal.

Step 8: Check the EP760 system status through the App.

## 6.3 Decommissioning

Step 1: Turn off the AC power on BLUEETTI App.

Step 2: Switch off the AC circuit breakers connected to the inverter GRID and BACKUP terminals.

Step 3: Switch off the inverter PV breaker.

Step 4: Press the power button on any B500 till the indicator on the button flashes green.

Step 5: The indicator continues to flash.

Step 6: When the indicator is off, B500 battery packs turn off.

Step 7: Switch off main switches for all B500 and the EP760 powers off.



### Warning

There is still residual voltage after the EP760 is powered off, which may cause electric shock or burns. Please wait at least 30 minutes before operating the system.

## 7. System Maintenance

### 7.1 USB firmware upgrade

The EP760 inverter supports firmware upgrades via a USB drive to optimize its performance and avoid failures caused by firmware errors.

Step 1: Connect the USB drive to a USB port on your computer.

Step 2: Download the upgrade file\*, unzip and store it on the USB drive.

Step 3: Connect the USB drive to the USB port on EP760.

Step 4: Power on EP760.

Step 5: The firmware upgrade starts automatically once the upgrade files are detected.

Step 6: The buzzer beeps once after the firmware is updated successfully. Please unplug the USB drive, or EP760 will report a USB Format Error.

Step 7: Pair EP760 with BLUETTI App, then you can check the firmware version in System information>> Firmware version. If any of the following occurs, please try the solutions provided. If the symptom persists after 5 attempts, contact the BLUETTI support team.

\* Please contact our company for further assistance.

Table 7-1

Error Description	Solution
USB Upgrade Failed.	Please contact the BLUETTI support team.
USB Format Error	1.Make sure the USB is formatted as FAT32 with no more than 32G in size. 2.Check if the upgrade files exist or expire. Please download the latest upgrade files.
Firmware version not updating or abnormal.	Please download the latest upgrade files. If the symptom persists, contact the BLUETTI support team.

### 7.2 OTA firmware upgrade

The EP760 also supports OTA firmware upgrade. For details, please refer to "Firmware Upgrade" in the BLUETTI App Instructions.

## 8. System Disposal

### 8.1 Remove the EP760 Inverter

When the inverter is no longer in use, it must be disposed of properly.

Step 1: Power off the system.

Step 2: Disconnect all electrical connections to the inverter, such as signal cable, DC input cable, power cable, AC input cable, grounding cable, etc.

Step 3: Remove the inverter and related parts.

### 8.2 Recycle the EP760 Inverter and B500 Battery Pack

When the battery pack reaches the end of its lifespan, it must be safely and carefully disposed of by the provisions of local laws and regulations.

Please contact our company for further assistance if the battery pack is

- a. Leaked or damaged.
- b. Out of warranty or severely degraded in performance.
- c. To be replaced or not intended for further use.

## 9. Specifications

PV	
Item	Description
Max. Input Power	9000W
VMax PV	550 d.c.V
PV Input operating Voltage Range	150-500 d.c.V
Maximum Operating PV input Current	12.5/12.5/12.5 d.c.A
Isc PV	15/15/15 d.c.A
Maximum Inverter Backfeed Current to Array	0.005m a.c.A

Grid	
Item	Description
Input Voltage Range	185~285Vac,L/N/PE
Rated Grid Voltage	230 a.c.V,L/N/PE
Grid Frequency Range	47.5 Hz~51.5 Hz
Rated Grid Frequency	50Hz
Max. Power from Grid	11500VA
Max. Current from Grid	50 a.c.A
Rated apparent Power to Grid	7600VA
Rated Current Output to Grid	33 a.c.A
Power Factor Range	-0.8~0.8
Maximum Output Fault Current	93 a.c.A/11mS
Maximum Output Overcurrent Protection	50 a.c.A
Inrush Current	830 a.c.A/75uS

Backup	
Item	Description
Rated Output Voltage	230 a.c.V,L/N/PE
Rated Frequency	50Hz
Rated Output Power	7600VA
Rated Output Current	33 a.c.A

Energy storage ports	
Item	Description
Storage Type	LiFePO4
Nominal Battery Voltage Range	86-113 d.c.V
Rated Input Current	85 d.c.A
Rated Output Current	90 d.c.A



## General Parameters

Item	Description
Ingress Protection	IP65
Inverter Technology	Isolated
Operating Temperature Range	- 20~50℃
Protection Class	Class I
Over Voltage Category	OVC III(AC),OVC II(PV)
Active Anti-islanding Method	Frequency Disturbance
Relative Humidity	5%-95%
Standby Power	75W
Noise	≤50dB (A)
Cooling	Forced air cooling
Working Altitude	≤2000m
Dimensions (L*W*H)	626mm×324mm×368mm
Net Weight	44kg
Communication	USB / WiFi / Bluetooth
Warranty	10 years

## 10. Troubleshooting

No.	Error Description	Troubleshooting
1.	BUS Overvoltage	Turn off the inverter and wait 30 minutes to restart it. If the symptom persists, please contact the BLUETTI support team.
2.	BUS2 Overvoltage	
3.	BUS Undervoltage	
4.	BUS2 Undervoltage	
5.	Hardware BUS Overvoltage	
6.	Hardware BUS2 Overvoltage	
7.	Hardware Battery Overvoltage	
8.	Hardware Inverter Overcurrent	
9.	Reserved	
10.	Hardware LLC1 Input Overcurrent	
11.	Reserved	
12.	Reserved	
13.	Auxiliary Power Undervoltage	
14.	DC Component Exception	
15.	Relay Failure	
16.	PV Connection Error	
17.	PV1 Overcurrent	Turn off the inverter and wait 30 minutes to restart it. If the symptom persists, please contact the BLUETTI support team.
18.	PV2 Overcurrent	
19.	PV3 Overcurrent	
20.	PV1 Voltage High	Check if the total voltage of solar panels exceeds the limit. Reduce the number of solar panels, and the inverter resumes operation after calibration.
21.	PV2 Voltage High	
22.	PV3 Voltage High	
23.	PV1 ISO Failure	Check the insulation resistor between solar array and grounding for a short circuit.
24.	PV2 ISO Failure	
25.	PV3 ISO Failure	

26.	Hardware PV1 Failure	
27.	Hardware PV2 Failure	
28.	Hardware PV3 Failure	
29.-30.	Reserved	
31.	Reserved	
32.	Fan Failure	Check if the inverter fan operates well.
33.	Zero Drift Anomaly	Turn off the inverter and wait 30 minutes to restart it. If the symptom persists, please contact the BLUETTI support team.
34.	Hardware Input Overcurrent	
35.	DC Input Voltage Low	Check if the DC voltage is too low.
36.	DC Input Voltage High	Check if the DC voltage is inconsistent with the battery specifications.
37.-39.	Reserved	
40.	Inverter Overload	
41.	Reserved	
42.	Reserved	
43.	L1 Inverter Output Failure	
44.	Reserved	
45.	Reserved	
46.	Reserved	
47.	Communication Failure	Turn off the inverter and wait 30 minutes to restart it. If the symptom persists, please contact the BLUETTI support team.
48.	Reserved	
49.	DSP Communication Interrupted	Turn off the inverter and wait 30 minutes to restart it. If the symptom persists, please contact the BLUETTI support team.

50.	BMS Communication Interrupted	Check that the external communication terminals are connected correctly and restart the device. If the symptom persists, please contact the BLUETTI support team.
51.	IOT Communication Interrupted	
52.	Zero Drift Anomaly-ARM	Turn off the inverter and wait 30 minutes to restart it. If the symptom persists, please contact the BLUETTI support team.
53.	RTC Read and Write Anomaly	
54.	Reserved	
55.	Operating Ambient Temperature Anomaly	Please make sure use the system within specific temperature range. If the symptom persists, please contact the BLUETTI support team.
56.	Temperature 1 Anomaly	
57.	Temperature 2 Anomaly	
58.	Temperature 3 Anomaly	
59.	Temperature 4 Anomaly	
60.	BMS Charge Protection	Check the details on BLUETTI app.
61.	BMS Discharge Protection	
62.	BMS System Failure	
63.-64.	Reserved	
65.	PV Overvoltage	
66.	Reserved	
67.	BUS Soft Start Anomaly	
68.-96.	Reserved	
97.	Grid Voltage High	If it occurs occasionally, the grid may go through abnormal working conditions. The inverter recovers after the grid resumes. If it occurs many times, check if the grid voltage and frequency support the inverter input specifications. Check the inverter AC circuit breaker and connections. If the voltage and frequency are beyond the range, please contact the BLUETTI support team.
98.	Grid Voltage Low	
99.	Grid Over Frequency	
100.	Grid Low Frequency	
101.		
102.	Grid Loss	

103.	PV1 Voltage Low	Check the PV setup for proper working condition, and that voltage is within inverter PV input voltage range.
104.	PV2 Voltage Low	
105.	PV3 Voltage Low	
106.	Reserved	
107.	DSP_Debug CAN Communication Failure	
108.	DSP_Debug RS485 Communication Failure	
109.	Grid Re-connection Anomaly	
110.-128.	Reserved	
129.	EEPROM Read and Write Anomaly	Please reconfigure the settings on BLUETTI app. If the symptom persists, please contact the BLUETTI support team.
130.-133.	Reserved	
134.	USB Format Error	The USB is formatted as FAT32 with no more than 32G in size. Check if the upgrade files exist or expire.
135.	USB Upgrade Failure	Turn on the inverter again. If the symptom persists, please contact the BLUETTI support team.
136.	Reserved	
137.	USB Communication Anomaly	
138.	USB No Upgrade File	Please download the latest upgrade files.
139.	CT Connection Direction Error	Check that the CT connection direction and phase sequence are correct. If the symptom persists, please contact the BLUETTI support team.
140.	Meter Communication Failure	Check whether the meter is powered and whether the communication cable between the meter and the EP760 is connected normally. If the problem persists, please contact technical support.
141.	Reserved	
142.	Reserved	
143.	Data Clearing in Progress	

## 11. FAQs (Frequently Asked Questions)

**Q1:** Why can't I connect to the EP760 via Bluetooth?

- A1:** (1) Check if the IoT controller is installed correctly and working properly (top light always on, bottom two lights flashing alternately).  
(2) Make sure that the App has access to the Bluetooth on your phone.  
(3) Turn on Bluetooth on your phone.  
(4) Make sure the app has access to the location on your phone.

**Q2:** Why can't I remotely connect to the EP760?

- A2:** (1) Check if the IoT controller is installed correctly and working properly (top light always on, bottom two lights flashing alternately).  
(2) Make sure that the EP760 is configured with WiFi.  
(3) Double-check if you entered the correct password.  
(4) Check if the WiFi is operating in the 2.4GHz frequency band.

**Q3:** Why is there no output from the BACKUP?

- A3:** (1) Check if the "AC Switch" on the App is turned on.  
(2) If the B500 batteries have no power and are not charging from the grid or solar system, the output will be automatically turned off.

**Q4:** How long does it take to start the EP760?

- A4:** The startup time may vary slightly depending on the startup method, but it should not exceed 3 minutes.

**Q5:** Can I connect a solar system that exceeds the PV input limits of EP760? Will the EP760 automatically adjust the input current?

- A5:** It depends on the voltage of your solar system. The EP760 can handle a solar system with a voltage range of 150V-500V and supports up to 3 PV inputs with a total power of 9000W (3000W each channel). It automatically adjusts the input current within these limits, with a maximum current limit of 12.5A.

**Q6:** Can household appliances be run on solar power while the solar panels are charging the batteries?

- A6:** Yes, the EP760 prioritizes solar power for running household appliances, and any extra energy is used to charge the battery. If you enable the "Feed to Grid" in the App, any surplus can be sent back to the grid.

- Q7:** How does the EP760 power my household appliances? Does it use solar power first and then switch to grid power when needed?
- A7:** The EP760 prioritizes solar energy for running household appliances. If there is not enough solar power available, the EP760 will combine solar power with battery storage to run your appliances. If there is still not enough power to meet demand, the EP760 will draw power from the grid.
- Q8:** What size solar system do I need to charge the EP760?
- A8:** Please ensure that your solar system meets the following specifications:
- (1) Open circuit voltage: 150V-500V
  - (2) Maximum input power: 9000W (3000W for PV1, PV2, and PV3)
  - (3) With the same connector (MC4).
- Q9:** Why isn't my solar system able to charge the EP760?
- A9:** (1) Make sure that the PV switch of the EP760 is in the "ON" position.  
(2) Check the connections of the solar panel and the PV input cables.  
(3) Check if any PV-related error messages are reported in the App.
- Q10:** How can I upgrade the EP760 firmware?
- A10:** Connect to the BLUETTI App via Bluetooth and follow the App instructions to upgrade the firmware.
- Q11:** What if the B500 battery pack's circuit breaker keeps tripping?
- A11:** Please don't manually reset it. Contact BLUETTI Support for assistance.
- Q12:** Why can't my EP760 charge from the grid?
- A12:** To enable grid charging, go to the advanced settings in the App and turn on the "Charge from Grid" option. Don't forget to set the charging schedule to optimize the process.
- Q13:** What should I do if the SoC readings are inaccurate?
- A13:** If you notice significant momentary fluctuations in the SoC, try performing two complete charge and discharge cycles on your EP760. This will help recalibrate the system and restore accurate SoC readings.

**For more information, please visit:**



@ BLUETTI Support

@ BLUETTI Official



@ bluetti\_inc



@bluetti.inc



@bluetti\_official



sale-au@bluettipower.com

SHENZHEN POWEROAK NEWENER CO., LTD.

Address: F19, BLD No.1, Kaidaer, Tongsha Rd No.168, Xili Street,  
Nanshan, Shenzhen, China

Web: <https://www.bluettipower.com>

Customer Service

Email: [sale-au@bluettipower.com](mailto:sale-au@bluettipower.com)

Address: Unit 15, 25 Gibbes Street Chatswood NSW 2067



Just Power On

P/N:17.0303.0677-00A0