

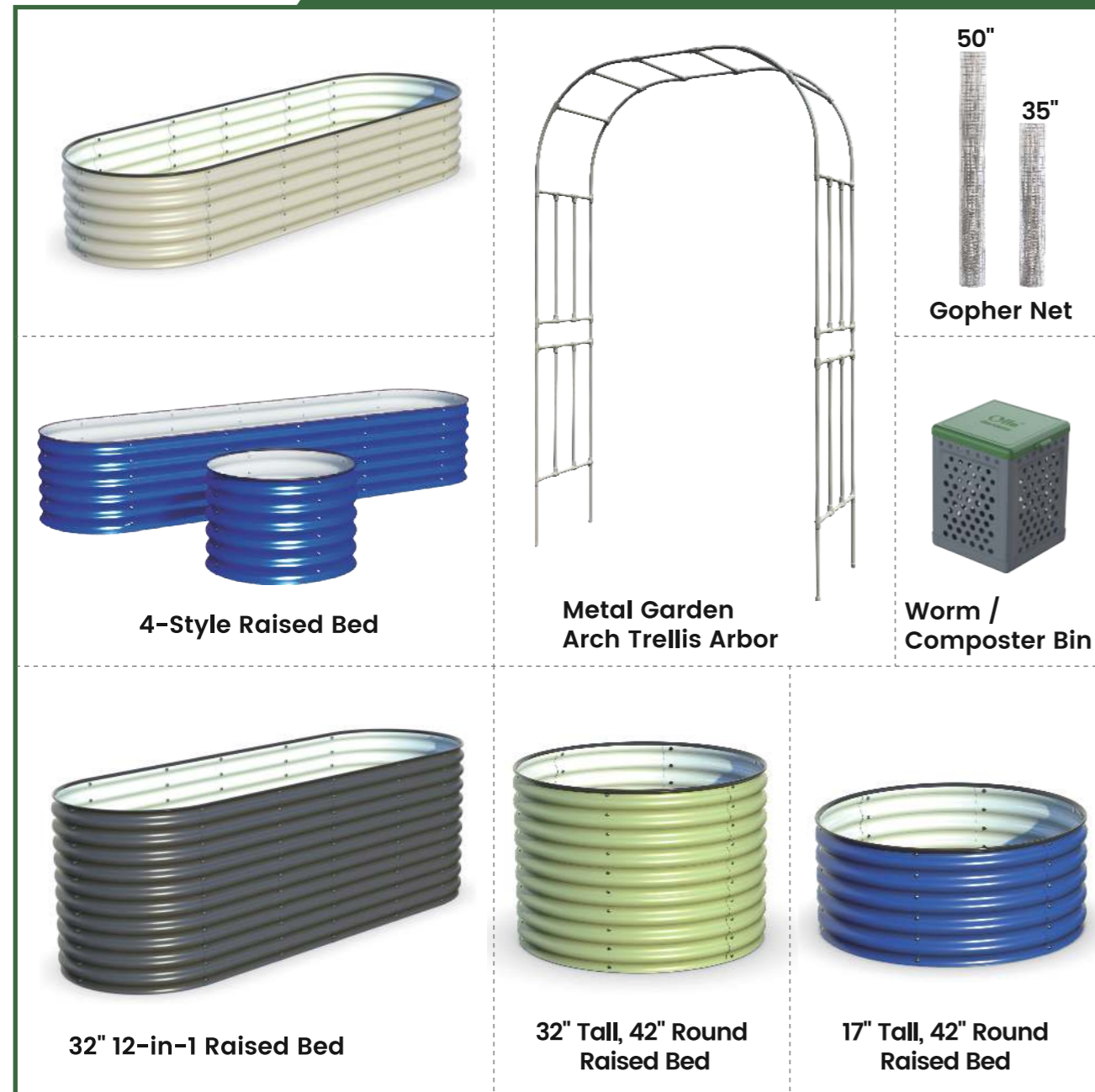

Olle Products & Accessories



✉ info@ollegardens.com

☎ 1-833-655-3872

🌐 www.ollegardens.com



4 Configuration Options









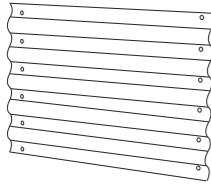
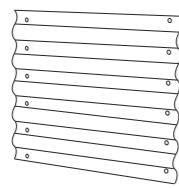

ULR SHAPED RAISED GARDEN BEDS ASSEMBLY INSTRUCTIONS

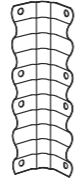

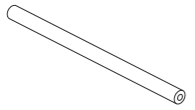
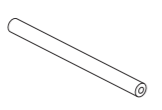
www.ollegardens.com

WHAT IS IN THE KIT ?

 Long Panels 24" 12 pcs	 Short Panels 18" 2 pcs	 Outside Corners 6 pcs	 Inside Corners 2 pcs	 Rubber Safety Edging 1 pc
 Long BRACING ROD 28" 2 pcs	 Short BRACING ROD 24" 1 pcs	 Connecting Bolt 1 pc	 Bolts, Washers and Nuts (Stainless Steel) 100 sets	 Wrench Tool (10mm) 1 pc

CAUTION

Please be aware of the sharp edges in the metal panels that may cause injury. The use of protective equipment such as gloves and closed-toe shoes is recommended.



PRODUCT ASSEMBLY

Step 1

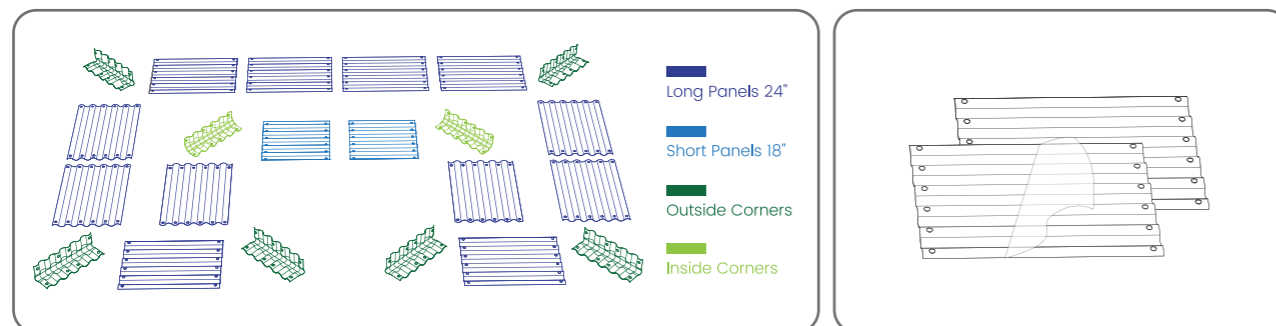

● Lay out the Corners and Panels in the design you wish to build. Make sure the inside (light green) and outside (green) corners are laid out correctly.

● Remove the protective film from both sides of the panels prior to assembly

Step 2

● Assemble a corner and a flat panel to start. Layer the corner on the outside. Put one bolt at the top and bottom of the panel set. Hand-tighten them.

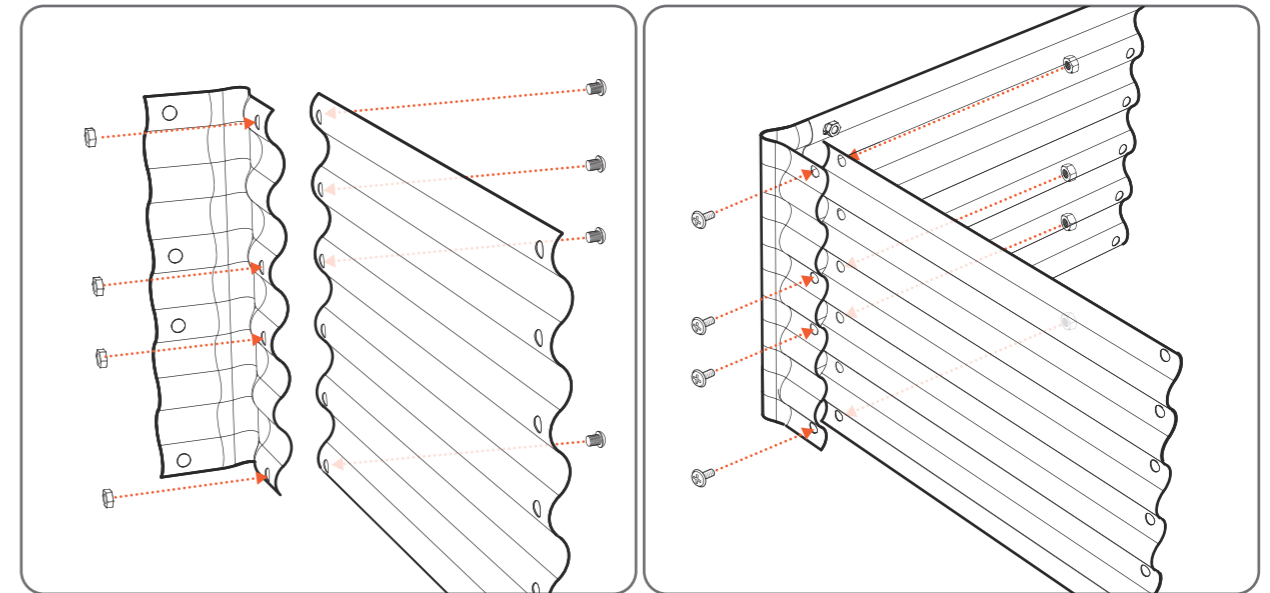

● Continue the same process to complete your garden bed.

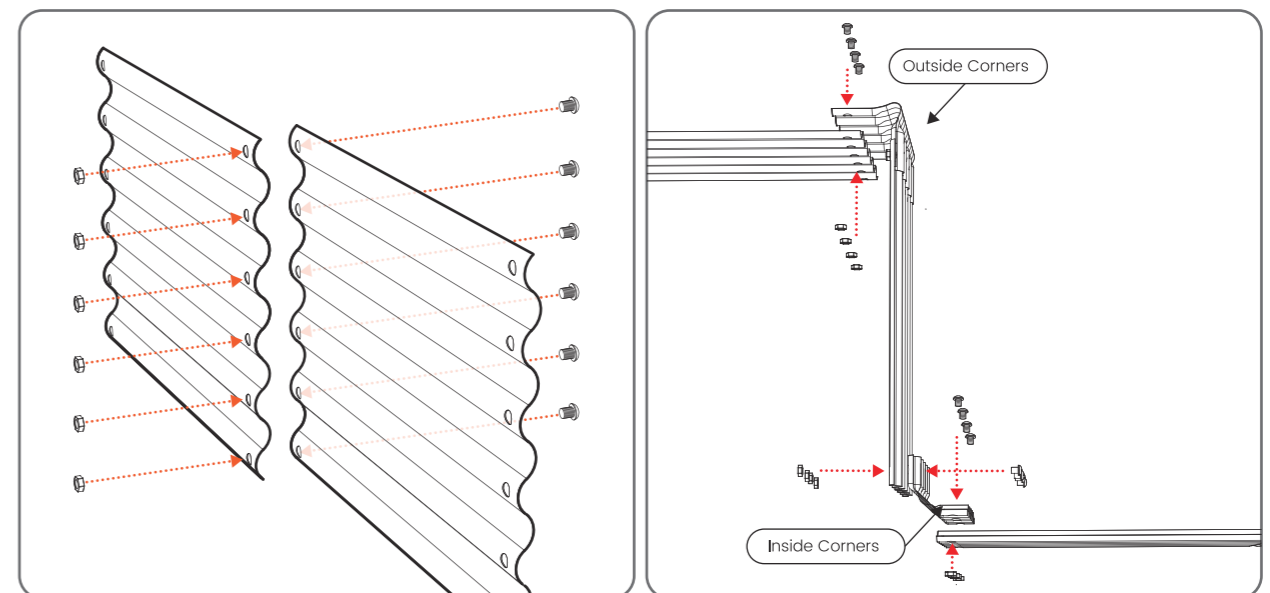

● After you have loosely assembled your desired shape, add the interior bolts on the outside and the washer and nut on the inside

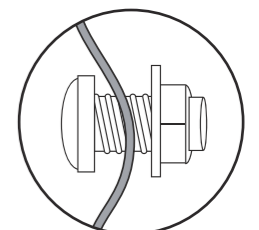

Step 3

- Pinch the panels together at the top and finish tightening the nuts from the top to the bottom with the wrench tool provided and a phillips head screwdriver to hold the bolt in place on the outside. To speed up the tightening process, you can use a metric number 10mm hand ratchet.

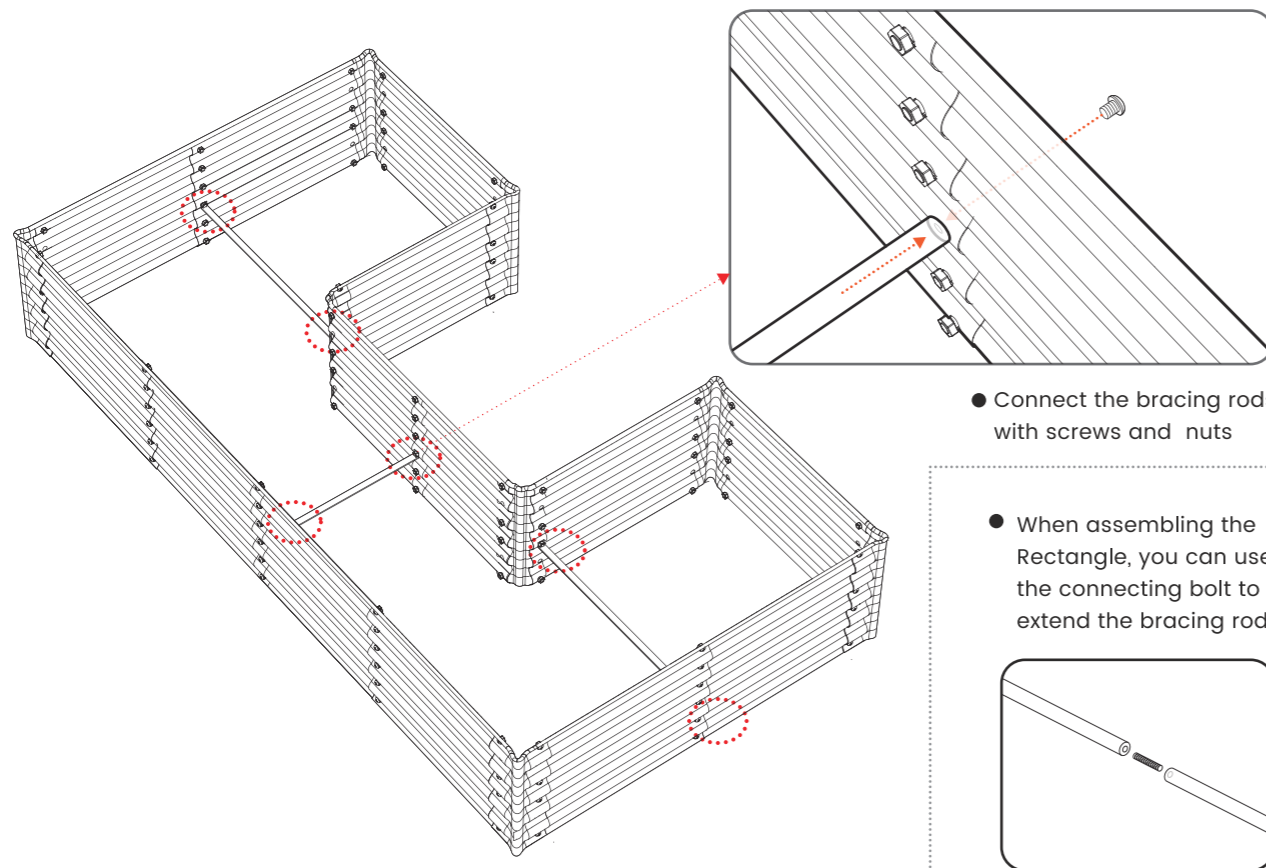
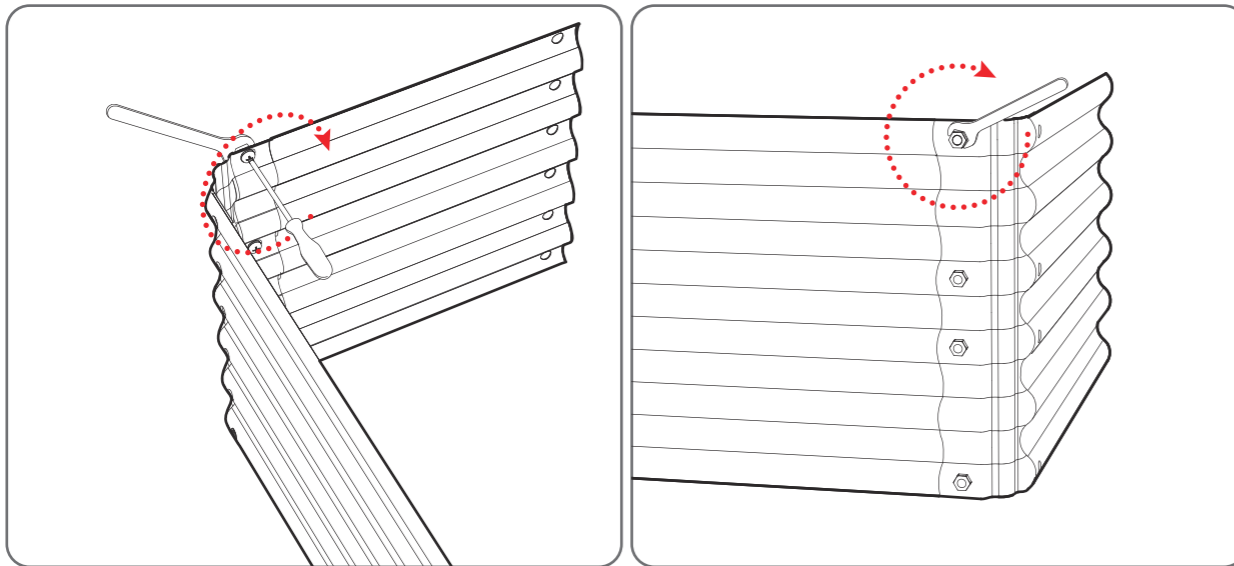

- Connect the bracing rods with screws and nuts

- When assembling the Rectangle, you can use the connecting bolt to extend the bracing rod

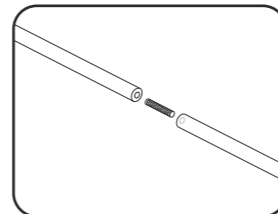

Step 4

- Slightly pull/stretch the Safety Rubber Capping as you push it onto the top edge of the garden bed and trim off the excess.

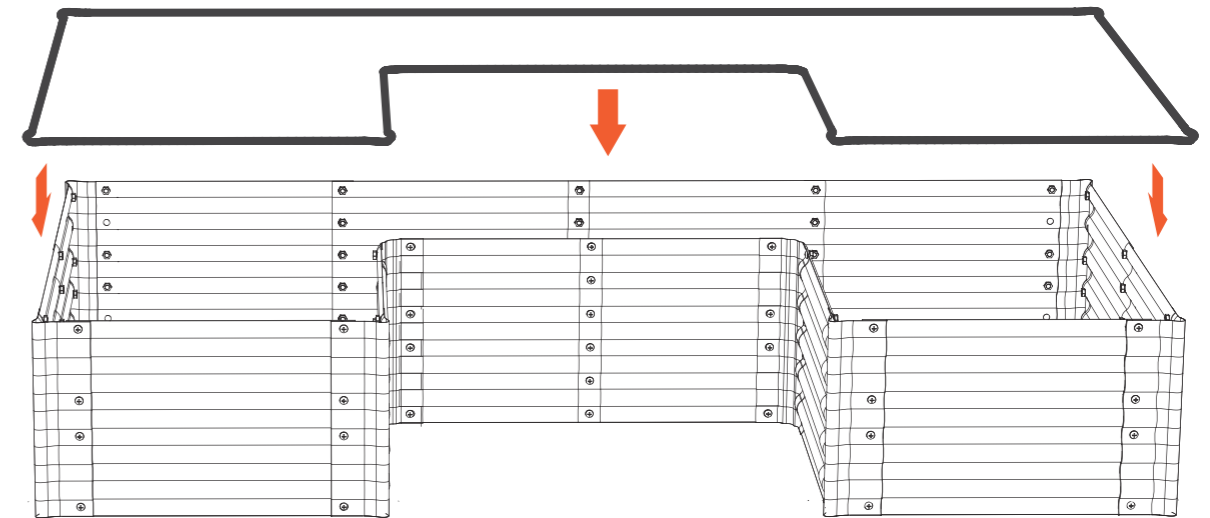
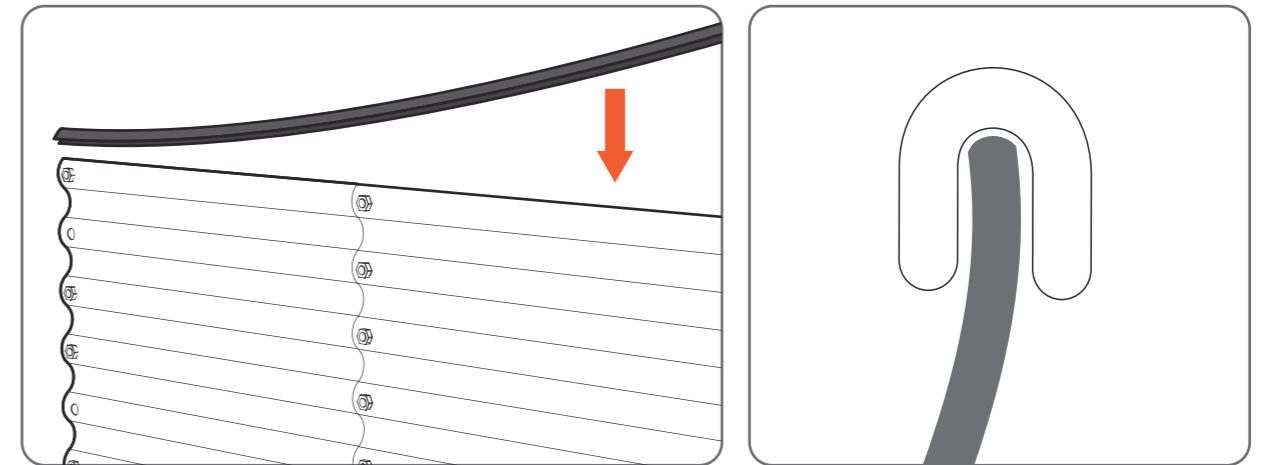

- (You can use the back of the wrench we provide or a screwdriver to slightly open the channel of the rubber edging only at the joints where the panels overlap allowing it to slip over both panels easier.)

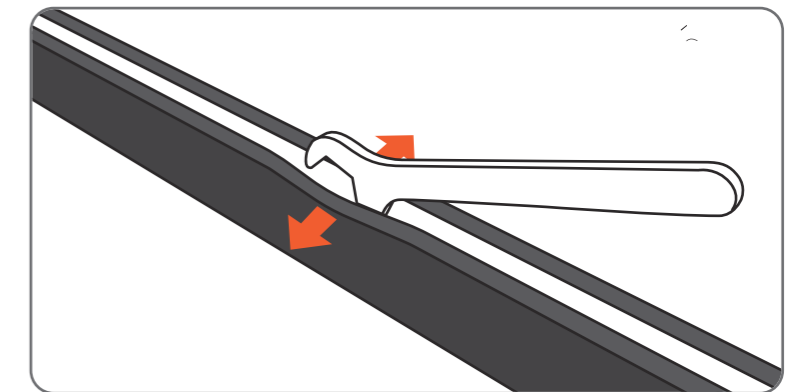



4 CONFIGURATION OPTIONS

Choose the option that fits your space

Option 1: U - Shaped

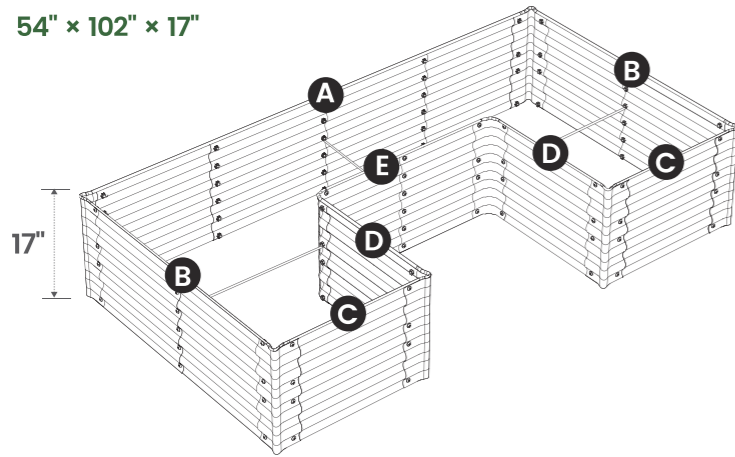
54" x 102" x 17"

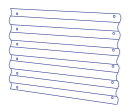
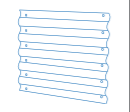
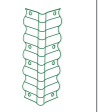
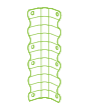

					
Long Panels 24"	Short Panels 18"	Outside Corners	Inside Corners	Long Bracing Rod	Short Bracing Rod
12 pcs	2 pcs	6 pcs	2 pcs	2 pcs	1 pcs

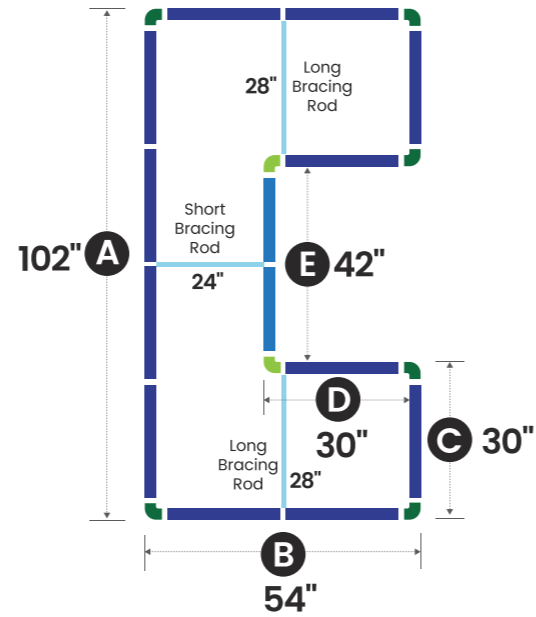



		
Long Panels 24"	Short Panels 18"	Bracing Rod
Outside Corners	Inside Corners	

Option 2: L - Shaped

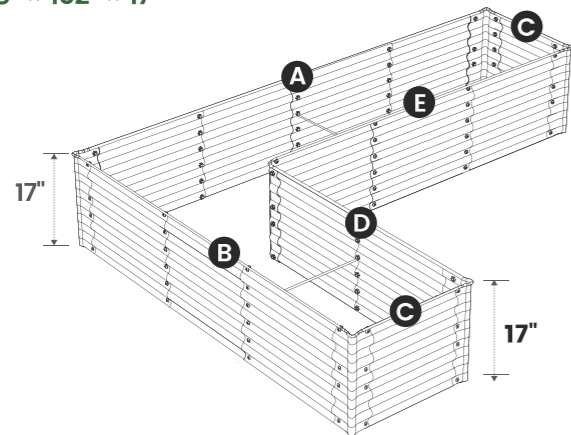
78" x 102" x 17"

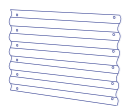
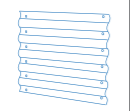
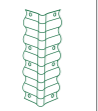
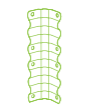

				
Long Panels 24"	Short Panels 18"	Outside Corners	Inside Corners	Long Bracing Rod
12 pcs	2 pcs	4 pcs	1 pcs	2 pcs

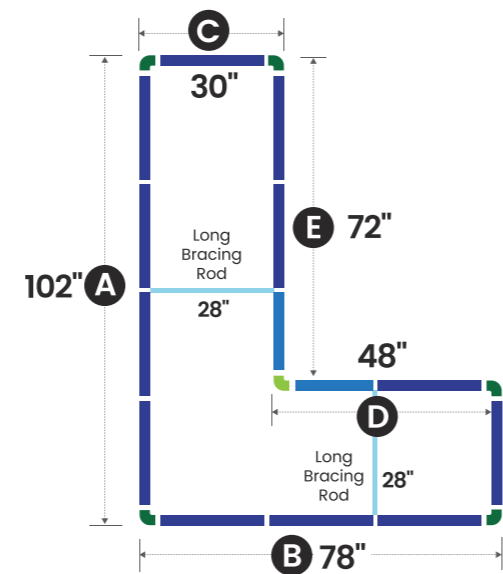





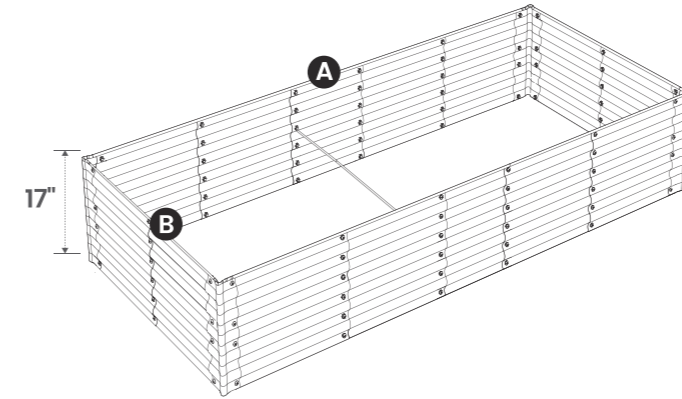

		
Long Panels 24"	Short Panels 18"	Bracing Rod
Outside Corners	Inside Corners	

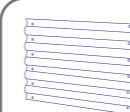
Option 3: Rectangle

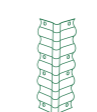
54" x 120" x 17"





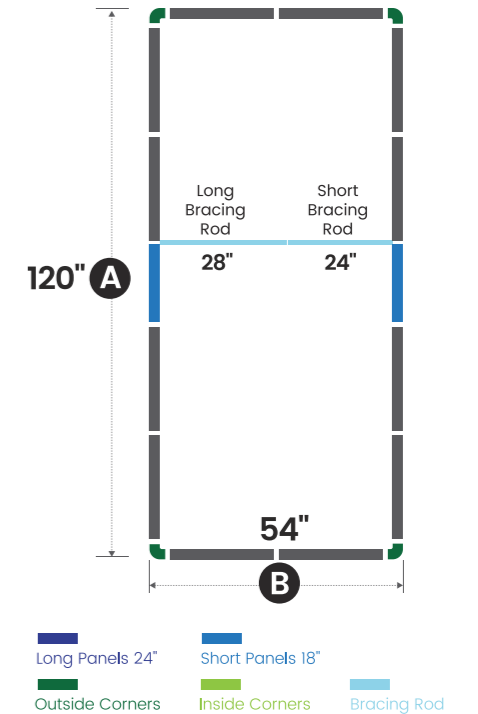

					
Long Panels 24"	Short Panels 18"	Outside Corners	Long Bracing Rod	Short Bracing Rod	Connecting Bolt
12 pcs	2 pcs	6 pcs	1 pcs	1 pcs	1 pc

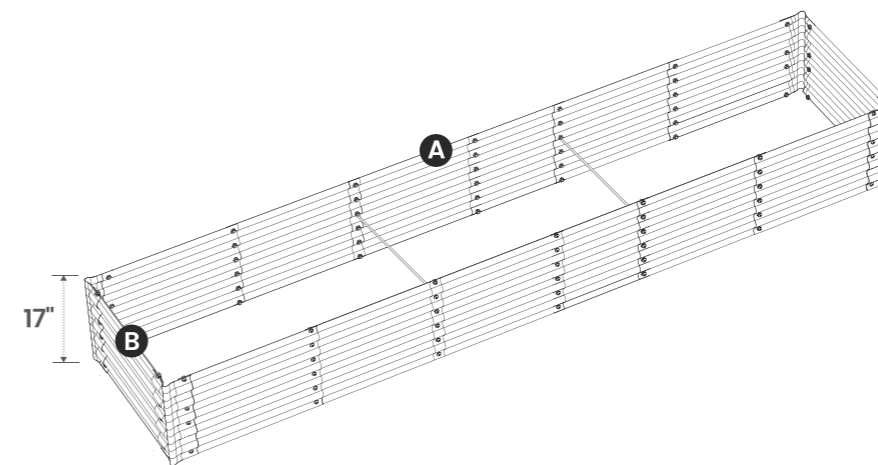

Option 4: Rectangle

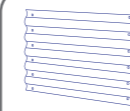
30" x 144" x 17"

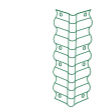

			
Long Panels 24"	Short Panels 18"	Outside Corners	Long Bracing Rod
12 pcs	2 pcs	6 pcs	2 pcs

