

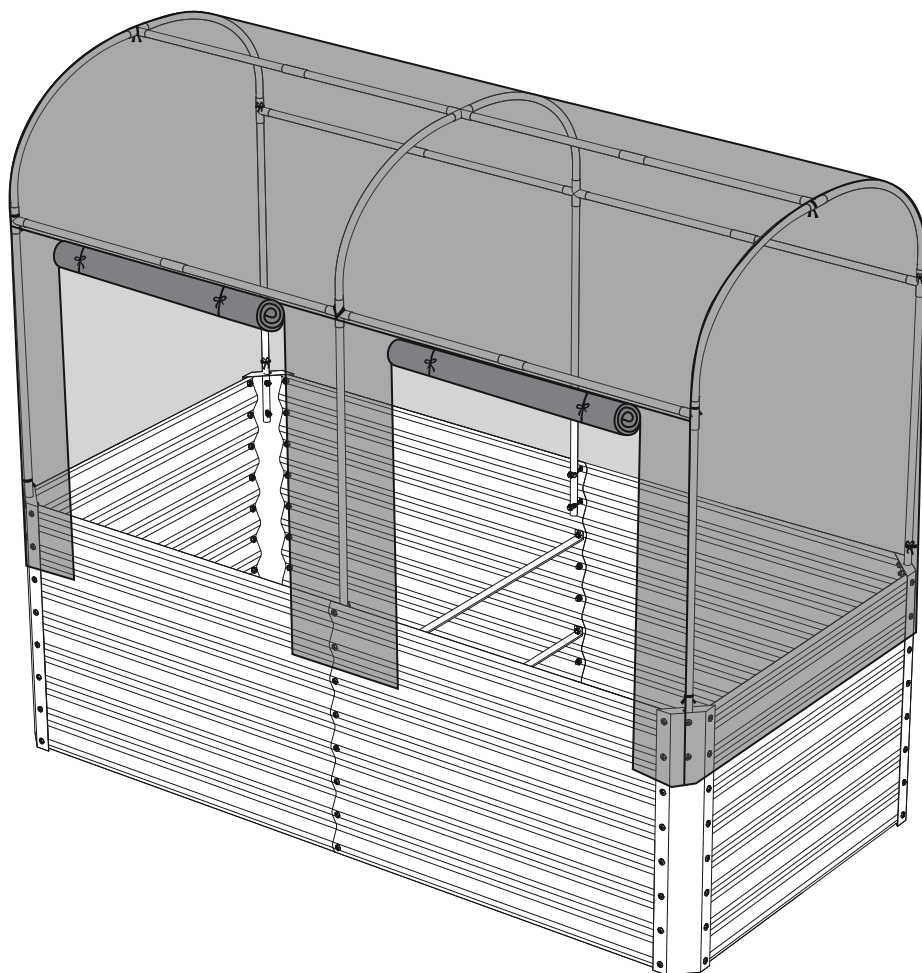

**SAVANA**

# GARDEN MESH NETTING

36" x 72" x 48"



## USER MANUAL

Fits Savana Raised Metal Garden Beds with Bases of 36" x 72"

## Notice

Please follow this manual's installation and usage instructions and retain for future reference.

- Identify and separate all frame tubes and connectors so they are easy to identify during assembly.
- Fasten all bolts, screws and knobs firmly and make sure all parts are in good working condition before beginning use.

## Hardware

**1** M6 X 30mm  
Short Screw



8 PCS

**2** M6 X 40mm  
Long Screw



4 PCS

**3** Nuts



12 PCS

**4** 3-Way Plastic  
Fitting



6 PCS

**5** 2-Way Plastic  
Fitting



6 PCS

**6** 4-Way Plastic  
Fitting



3 PCS

## Parts

**A** Vertical Tube  
760mm



6 PCS

**B** Horizontal Tube  
417.5 mm



12 PCS

**C** Elbow Tube  
R385mm



6 PCS

**D** Cover

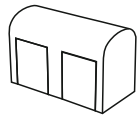

1 PC

## Product Installation Steps

1

Affix the 4 vertical tubes (A) to each of the 4 corners of the garden bed with 2 short screws (#1) and 2 nuts (#3) per tube. Then connect the remaining 2 vertical tubes (A) to the sides of the bed using 2 long screws (#2) and 2 nuts (#3) per tube.

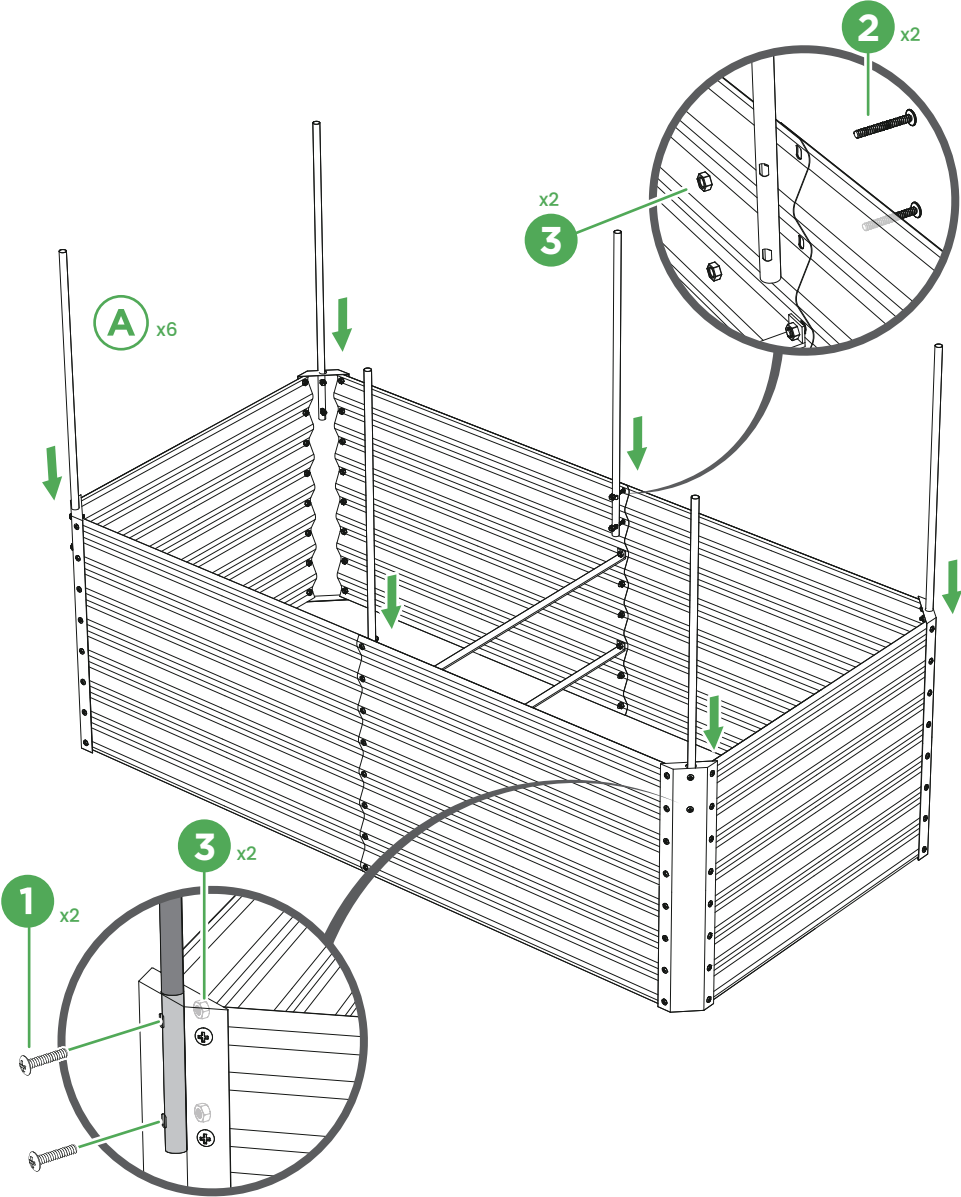

2

Use 3-way plastic fittings (#4) to connect the elbow tubes (C) to the vertical tubes (A) in each corner. Use 4-way plastic fittings (#6) to connect the tubes at the sides of the bed. Turn and orient the plastic fittings as shown.

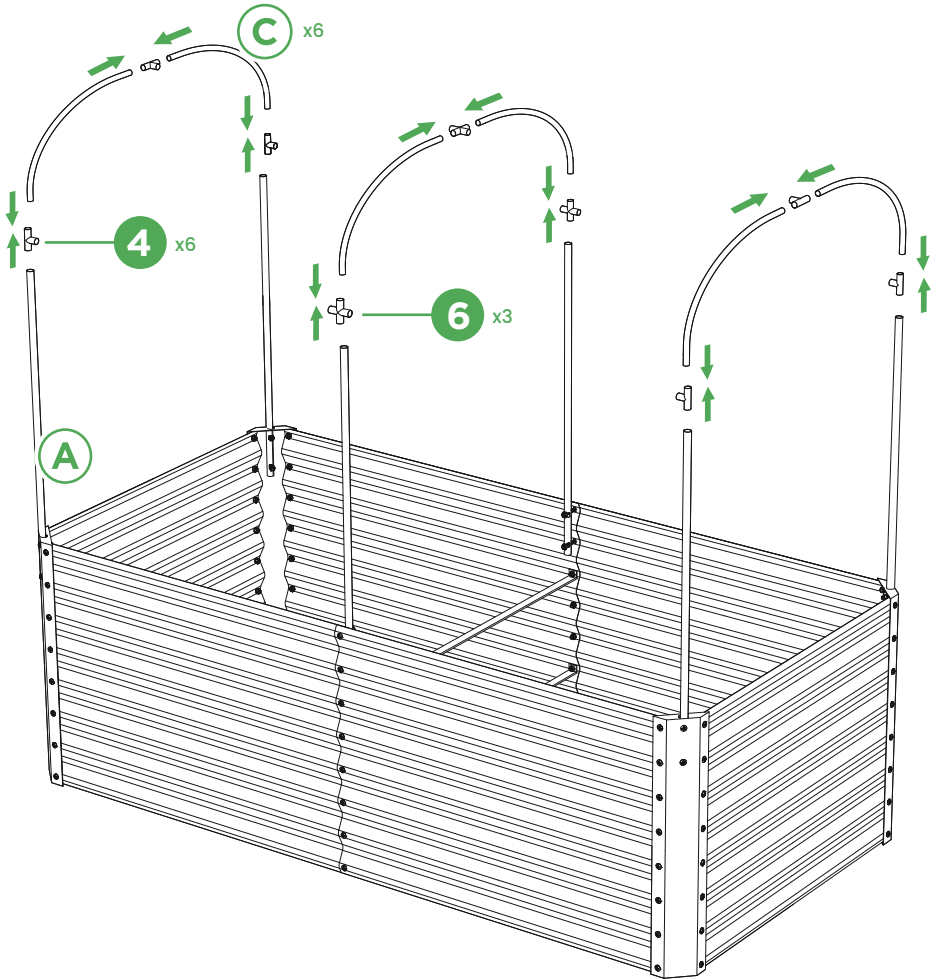

3

Connect a pair of 2 horizontal tubes (B) to each other with a 2-way plastic fitting (#5). Repeat this to connect all the horizontal tubes (B) into 6 pairs. Then connect the paired horizontal tubes (B) to the vertical tubes (A) and elbow tubes (C) with the plastic fittings.

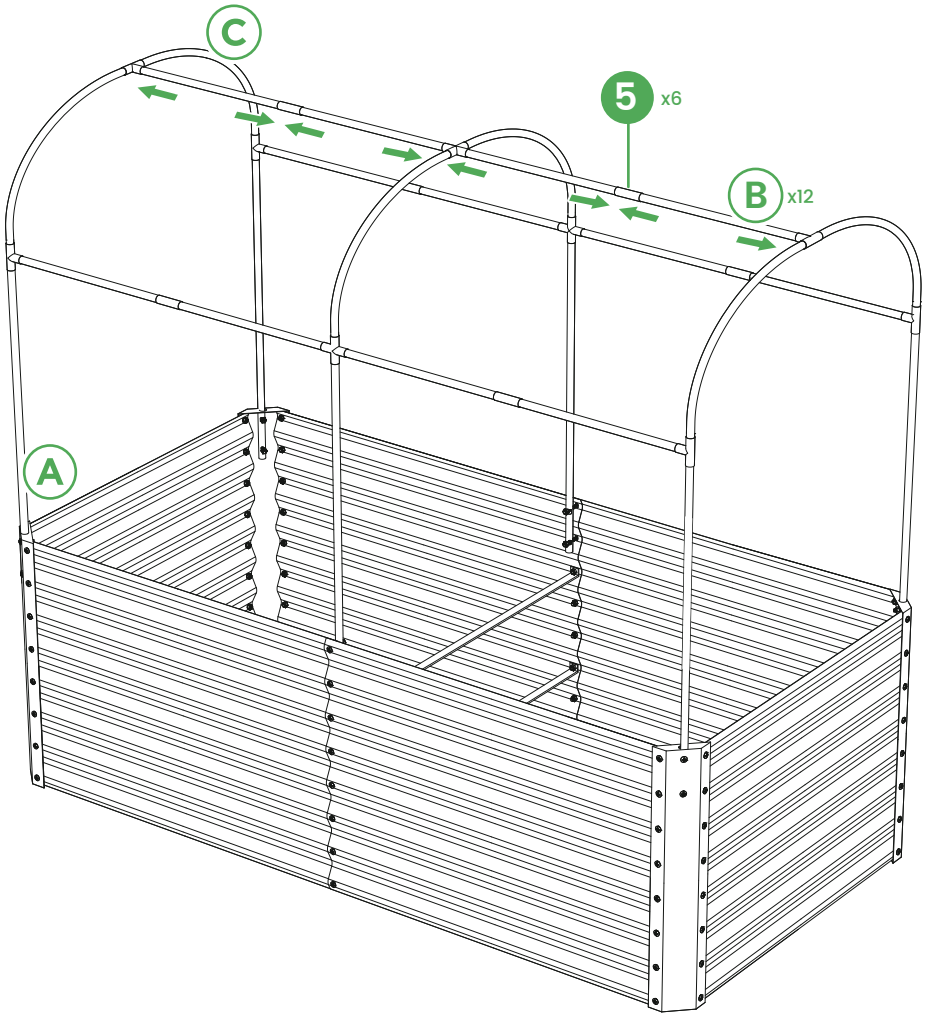

4

Put the cover (D) on the frame, securing the cover to the tubes with its straps.

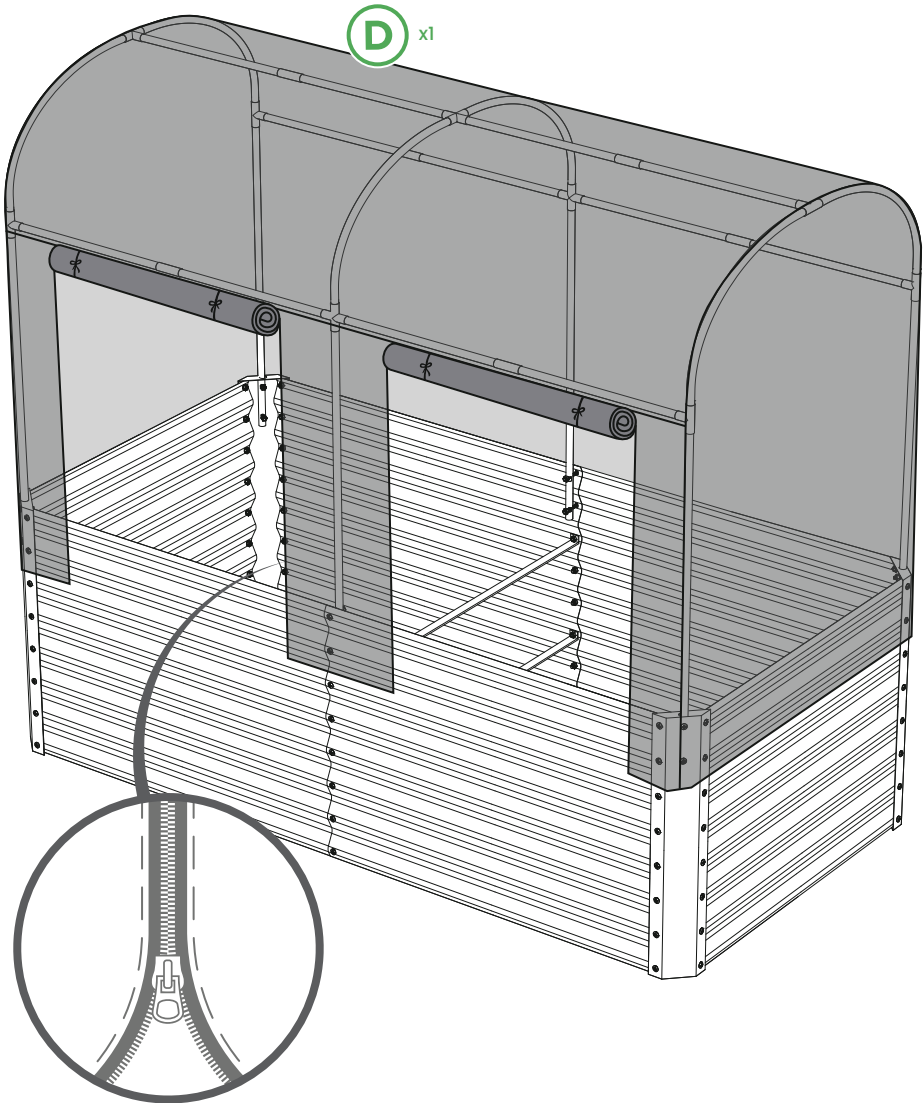

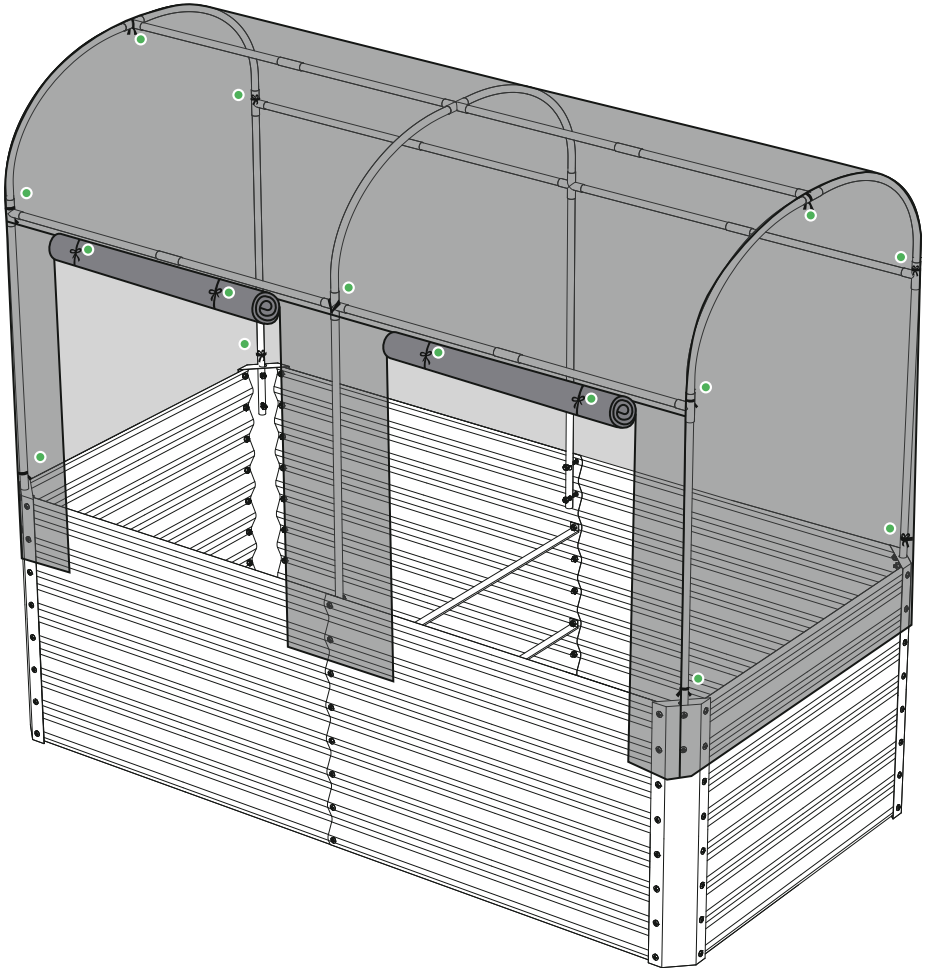

## Maintenance and Storage

Use extreme care when disassembling and storing this cover. Carefully remove the cover and fold it. Gently pull the frame tubes out of the connectors. Place all components into the original box or a plastic tote. Use caution when storing the cover; avoid placing it on or near the sharp edges of the frame components to prevent scratches and tears.

Although the cover is relatively durable, it is still possible to puncture holes in the material if care is not taken when setting up, disassembling, and storing the cover.



**SAVANA**

## HELP CENTER

Have questions about your product? We're here to help.

[hello@savanagarden.com](mailto:hello@savanagarden.com)

Visit us at:

[www.savanagarden.com](http://www.savanagarden.com)



Chat Support



Product Inquiry



Orders FAQ



Product Assembly



Shipping



Returns & Refunds