

SMARTX96-1E

96mm² Smart Energy Meter for Single and Three Phase Electrical Systems

1 Introduction

This document provides operating, maintenance and installation instructions. This unit measures and displays the characteristics of Single Phase Two Wire (1P2W), Three Phase Three Wire (3P3W) and Three Phase Four Wire (3P4W) networks.

The measuring parameters include Voltage (V), Current (A), Frequency (Hz), Power Factor (PF), Active, Reactive & Apparent Power (kW/kVA/kVAh), Imported, Exported and Total Active Energy (kWh), Imported, Exported and Total Reactive Energy (kVAh).

The unit also measures Maximum Demand Current & Maximum Demand Power, this is measured over preset time periods of up to 60 minutes.

This unit is a 1A or 5A Current Transformer operated and can be configured to work with a wide range of CTs. The unit can also be configured to work with a Voltage Transformer.

Unlike other alternatives, our 96mm² panel meter has built-in Pulsed outputs and RS485 Modbus RTU communications; no separate modules are required to add comms to this device.

Instead of programming the meter through modbus, we have incorporated a password protected set-up menu within the meters software, allowing configuration without having to interrogate through comms.

This unit does not require a separate auxiliary supply for power. The self-supplied auxiliary comes from any Phase that is connected to the voltage inputs, meaning should one of the Phases fail, the unit will power itself from another Phase, ensuring the meter continues to measure usage.

The SMART X96-1 meter comes with sealable terminal covers to ensure that the installation is safe and tamper-proof.

2 Start Up Screens

	The first screen lights up all display segments and can be used as a display check.
	The second screen indicates the firmware installed on the unit and its build number.
	The interface performs a self-test and indicates the result if the test passes.

*After a short delay, the screen will display active energy measurements.

3 Measurements

The buttons operate as follows:

	Selects the Phase Summary display screens. In Set-up Mode, this is the "Escape" button.
	Selects the Voltage and Current display screens. In Set-up Mode, this is the "Left" button.
	Select the Frequency and Power factor display screens. In Set-up Mode, this is the "Up" button.
	Select the Power display screens. In Set-up Mode, this is the "Down" button.
	Select the Energy display screens. In Set-up mode, this is the "Right" or "Enter" button.

3.1 Phase Summary

Each press of the **Ph S** button selects a new parameter:

	Phase 1 Summary: Active Power Live to Neutral Voltage Current Total kWh
	Phase 2 Summary: Active Power Live to Neutral Voltage Current Total kWh
	Phase 3 Summary: Active Power Live to Neutral Voltage Current Total kWh
	Phase 1 Summary: Active Power Live to Neutral Voltage Current Total kVAh
	Phase 2 Summary: Active Power Live to Neutral Voltage Current Total kVAh
	Phase 3 Summary: Active Power Live to Neutral Voltage Current Total kVAh

3.2 Voltage and Current

Each press of the **V/A** button selects a new parameter:

	Phase to Neutral Voltage
	Phase to Phase Voltage
	Current per Phase
	Voltage Total (1st) Harmonic Distortion Percentage.
	Current Total (1st) Harmonic Distortion Percentage.

3.3 Phase Sequence

Toggle through the **V/A** screens to check your Phase Sequence connections are aligned:

	U (Voltage) sequence I (Current) sequence
--	--

3.4 Frequency and Power Factor and Demand

Each press of the **MD PF Hz** button selects a new range:

	Total Frequency Total Power Factor
	Power Factor per Phase
	Maximum Current Demand per Phase

	Max Demand Active Power Max Demand Reactive Power Max Demand Apparent Power
--	---

3.5 Power

Each press of the **P** button select a new range:

	Active Power per Phase
	Reactive Power per Phase
	Apparent Power per Phase
	Total Active Power Total Reactive Power Total Apparent Power

3.6 Energy Measurements

Each press of the **E** button selects a new range:

	Total Reactive Energy
	Imported Active Energy
	Exported Active Energy
	Imported Reactive Energy
	Exported Reactive Energy

4 Set Up

To enter set-up mode, hold the **E** button for 3 seconds, until the password screen appears.

	Set up is password-protected so you must enter the correct password (default '1000') before proceeding.
	Use the MD PF Hz and P buttons to adjust the flashing number. Press the E button to move to the next number. Hold the E button to continue.
	If an incorrect password is entered, the display will show: "PASS Err" If a correct password is entered, you will see the first setup screen: "Set Comms"

To exit setting-up mode, press the **Ph S** button and you will return to a parameter screen.

4.1 Set-up Entry Methods

Some menu items, such as password and CT, require a four-digit number entry while others, such as supply system, require selection from a number of options.

4.1.1 Menu Option Selection

- Use the **MD PF Hz** and **P** buttons to scroll through the different options of the set up menu.
- Hold the **E** button to confirm your selection.
- If an item flashes, then it can be adjusted by using the **MD PF Hz** and **P** buttons.
- Once you have adjusted the option appropriately, you will need to save the change by holding the **E** button. The word "Good" should appear briefly, then the menu option will stop flashing.
- On completion of all setting-up, press the **Ph S** button and you will return to a parameter screen.

4.1.2 Number Entry Procedure

When Setting up the unit, some screens require the entering of a number. In particular, on entry to the setting up section, a password must be entered. Digits are set individually, from left to right. The procedure is as follows:

- The current digit to be set flashes and then can be adjusted using the **MD PF Hz** and **P** buttons.
- To move to the next digit, press the **E** button.
- Save the change by holding the **E** button. The word "Good" should appear briefly, then the menu option will stop flashing.

4.2 Communication

There is a RS485 port that can be used for communication using Modbus RTU protocol. For Modbus RTU, parameters are programmed through the set-up menu.

	Configure Comms Settings contains sub-menu options
	Set Meter Modbus Address (ID) Numerical: 001-247
	Set Baud Rate Options: 2400, 4800, 9600, 19200, 38400.
	Set Parity Options: none, even, odd.
	Set Stop Bits Options: 1, 2.

On completion of the entry procedure, press the **Ph S** button and you will return to a parameter screen.

4.3 Current Transformer (CT)

This unit is CT Operated, the primary (CT1) and secondary (CT2) of the current transformer need to be programmed correctly for the meter to scale the inputs accordingly.

	Configure CT Settings contains sub-menu options
	CT Secondary (CT2) Options: 0.1A (Not Configurable)
	CT Primary (CT1) Numerical: 0001-9999A. 0005A default

Please note as this is a MID approved device, you will only have one opportunity to set CT Primary/Secondary.

4.4 Pulse Settings

The SMART X96-1 has two pulsed outputs. Pulse 1 is configurable; you can set the pulse rate and duration, as well as the parameter to pulse for. Pulse 2 is factory set and cannot be modified.

	Configure Pulse 1 contains sub-menu options
	Pulse 1 Output Options: Import kWh, Export kWh, Total kWh, Import kVAh, Export kVAh, Total kVAh.
	Pulse 1 Rate (pulses per kWh) Options: 0.001, 0.01, 0.1, 1, 10, 100, 1000.*
	Pulse Time (duration) Options: 60, 100, 200ms.

* The Pulse Rate can be set as follows:
0.001 = 1 pulse per 1 Wh/VArh (1000 pulses per kWh/kVAh)
0.01 = 1 pulse per 10 Wh/VArh (100 pulses per kWh/kVAh)
0.1 = 1 pulse per 100 Wh/VArh (10 pulses per kWh/kVAh)
1 = 1 pulse per 1 kWh/kVAh
10 = 1 pulse per 10 kWh/kVAh
100 = 1 pulse per 100 kWh/kVAh
1000 = 1 pulse per 1000 kWh/kVAh

4.5 Maximum Demand

This sets the period of time (in minutes) in which the Current and Power readings are recorded for maximum demand measurements.

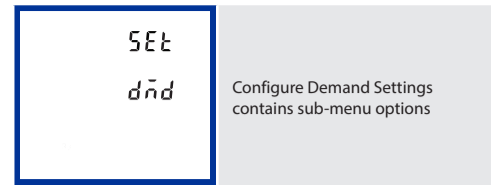

To enter set-up menu, hold the **E** button for 3 seconds, until the screen appears.



* The Demand Method can be configured as follows:
Sliding = 0–60 minutes, 1–61 minutes, 2–62 minutes etc
Fixed = 0–60 minutes, 60–120 minutes, 120–180 minutes etc

4.6 Time Settings

The time options of the meter are stored in this menu option.

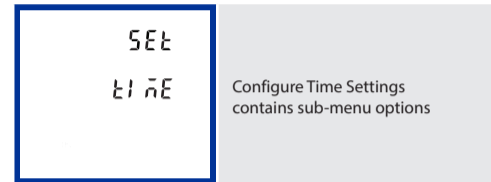

To enter set-up menu, hold the **E** button for 3 seconds, until the screen appears.

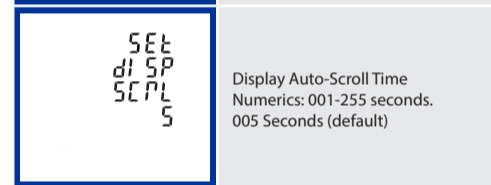
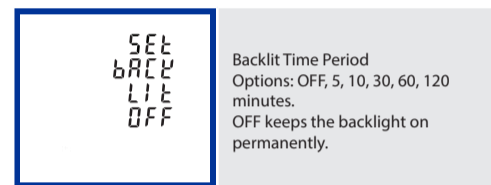

4.7 System Settings

This menu option allows the parameters to be set to 0.

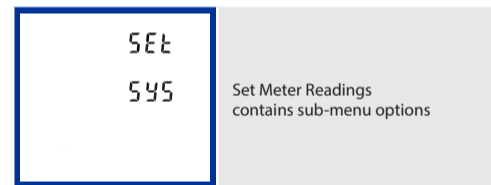

To enter set-up menu, hold the **E** button for 3 seconds, until the screen appears.

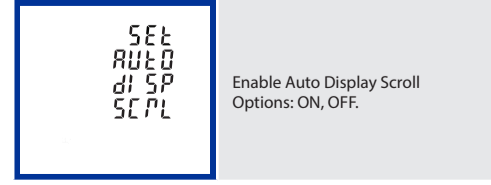
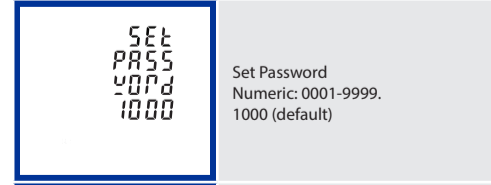
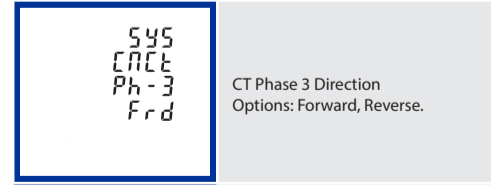
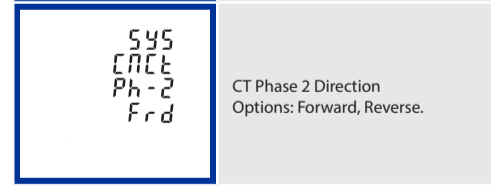
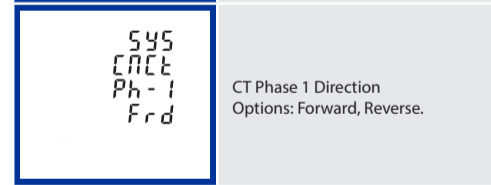
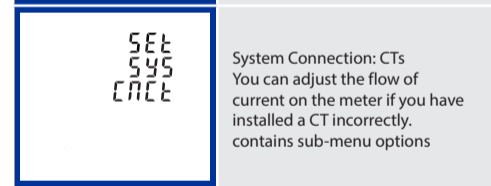
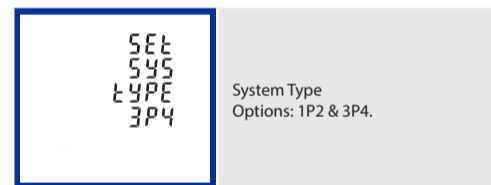

4.8 Reset Settings

This menu option allows the parameters to be reset to 0.

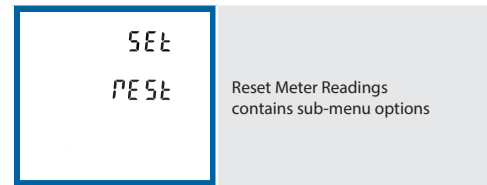

To enter set-up menu, hold the **E** button for 3 seconds, until the screen appears.



5 Specifications

5.1 Measured Parameters

The unit can monitor and display the following parameters of a Single Phase Two Wire (1P2W), Three Phase Three Wire (3P3W) or Three Phase Four Wire (3P4W) system.

5.1.1 Voltage and Current

- Phase to Neutral Voltages 100 to 276V AC (not for 3P3W supplies).
- Phase to Phase Voltages 174 to 480V AC (3 Phase supplies only).
- Percentage total Voltage Harmonic Distortion (U THD%) for each Phase to N (not for 3P3W supplies).
- Percentage Voltage THD% between Phases (3 Phase supplies only).
- Percentage total Current Harmonic Distortion (I THD%) for each Phase.

5.1.2 Power factor and Frequency and Max. Demand

- Frequency in Hz (45–66Hz)
- Instantaneous power:
- Power 0 to 999MW
- Reactive power 0 to 999MVA
- Volt-amps 0 to 999MVA
- Maximum demanded power since last Demand reset
- Power factor
- Maximum neutral demand current, since the last Demand reset (for 3 Phase supplies only)

5.1.3 Energy Measurements

- Imported/Exported Active Energy 0 to 9999999.9 kWh
- Imported/Exported Reactive Energy 0 to 9999999.9 kVArh
- Total Active Energy 0 to 9999999.9 kWh
- Total Reactive Energy 0 to 9999999.9 kVArh

5.2 Measured Inputs

Voltage inputs through 4-way fixed connector with 2.5mm² stranded wire capacity. Single Phase Two Wire (1P2W), Three Phase Three Wire (3P3W) or Three Phase Four Wire (3P4W) unbalanced. Line frequency measured from L1 Voltage or L3 Voltage. Three Current inputs (six physical terminals) with 2.5mm² stranded wire capacity for connection of external CTs. Nominal rated input Current 5A or 1A AC RMS.

5.3 Accuracy

- Voltage (L-N / L-L) 0.5% of range maximum
- Current 0.5% of nominal
- Frequency 0.2% of mid-frequency
- Power Factor 1% of unity (0.01)
- Active Power (W) ±1% of range maximum
- Reactive Power (VAR) ±1% of range maximum
- Apparent Power (VA) ±1% of range maximum
- Active Energy (Wh) Class 1 IEC 62053-21 or Class 0.5 IEC 62053-22
- Reactive Energy (VArh) Class 2 IEC 62053-23
- Total Harmonic Distortion 1% up to 63rd Harmonic

5.4 Auxiliary Supply

This unit does not require a separate auxiliary supply; the unit draws the necessary power from the voltage input connections. If a three phase supply is connected, and the phase that is powering the unit fails, it will change the phase supply to avoid shutting down.

5.5 Interfaces for External Monitoring

Three interfaces are provided:

- RS485 communication channel that can be programmed for Modbus RTU protocol
- Relay output indicating real-time measured energy. (configurable)
- Pulse output 3200imp/kWh (not configurable)

The Modbus configuration (baud rate etc.) and the pulse relay output assignments (kW/kVArh, import/export etc.) are configured through the set-up screens.

5.5.1 Pulsed Outputs

The pulsed outputs are "passive type" and comply with Class A IEC 62053-31. The pulse output can be set to generate pulses to represent kWh or kVArh.

The Pulse Rate can be set as follows:
0.001 = 1 pulse per 1 Wh/VArh (1000 pulses per kWh/kVArh)
0.01 = 1 pulse per 10 Wh/VArh (100 pulses per kWh/kVArh)
0.1 = 1 pulse per 100 Wh/VArh (10 pulses per kWh/kVArh)
1 = 1 pulse per 1 kWh/kVArh
10 = 1 pulse per 10 kWh/kVArh
100 = 1 pulse per 100 kWh/kVArh
1000 = 1 pulse per 1000 kWh/kVArh

The Pulse width can be set as 200/100/60 ms.

5.5.2 RS485 Output for Modbus RTU

For Modbus RTU, the following RS485 communication parameters can be configured from the set-up menu:

Baud rate 2400, 4800, 9600, 19200, 38400

Parity none (default) / even / odd

Stop bits 1 or 2

RS485 network address three digit number, 001 to 247

Response Time <100ms

5.6 Reference Conditions of Influence Quantities

Influence Quantities are variables that affect measurement errors to a minor degree. Accuracy is verified under nominal value (within the specified tolerance) of these conditions.

- Ambient temperature 23°C ±1°C
- Input waveform 50 or 60Hz ±2%
- Input waveform Sinusoidal (distortion factor < 0.005)
- Auxiliary supply voltage Nominal ±1%
- Auxiliary supply frequency Nominal ±1%
- Auxiliary supply waveform (if AC) Sinusoidal (distortion factor < 0.05)
- Magnetic field of external origin Terrestrial flux

5.7 Environment

- Operating temperature -25°C to +55°C*
- Storage temperature -40°C to +70°C*
- Relative humidity 0 to 95%, non-condensing
- Altitude <2000m
- Warm up time 1 minute
- Vibration 10Hz to 50Hz, IEC 60068-2-6, 2g
- Electromagnetic Environment E2
- Mechanical Environment M1
- Pollution Degree II

*Maximum operating and storage temperatures are in the context of typical daily and seasonal variation.

5.8 Mechanics

- Dimensions 96mm x 96mm x 74mm (W x H x D)
- Mounting 92mm² Panel Cutout
- Sealing IP52 indoor
- Material Self-extinguishing UL 94 V-0

5.9 Declaration of Conformity

We, Eastron (Metering) Europe Limited, declare under our sole responsibility as the manufacturer that the poly Phase multifunction electrical energy meter "SMART X96-1E" correspond to the production model described in the EC-type examination certificate and to the requirements of the Directive 2014/32/EU EU type examination certificate number 0120/SGS0288. Identification number of the NB 0120.

Seller Details:

Smart Process & Control LTD

Unit 11, Totman Close,

Brook Road Industrial Estate,

Rayleigh, Essex,

SS6 7UZ

Telephone: 01268 773422

www.smartprocess.co.uk

Specifications are subject to change without notice

6 Dimensions

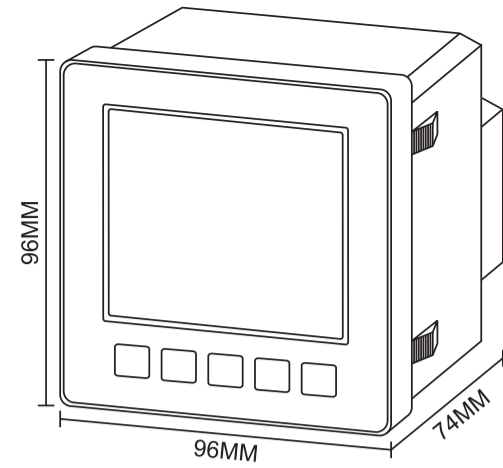

The panel meter fits in a 92mm x 92mm cutout.

7 Installation

7.1 Single Phase two wires

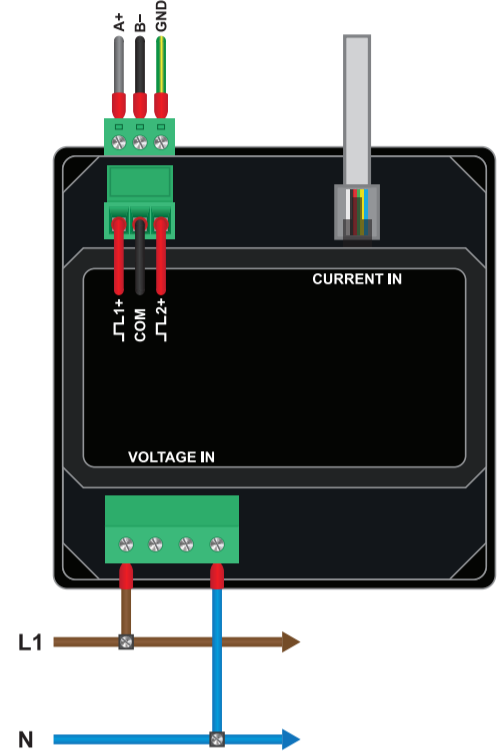

7.2 Three Phase four wires

