

# FIRMAN®

## OWNER'S MANUAL DUAL FUEL GENERATOR



MODEL NUMBER  
**H08051**  
Rev Level:00

**IMPORTANT:** Read all safety precautions and instructions carefully before operating equipment.



Ensure engine is stopped and level before performing any maintenance or service.

Record product information to reference when ordering parts or obtaining warranty coverage.



**DO NOT RETURN TO  
STORE!**



CALL US FIRST!  
CUSTOMER HOTLINE  
1-844-347-6261

FOR QUESTIONS OR SERVICE  
INFORMATION

Serial Number: \_\_\_\_\_

Purchase Date: \_\_\_\_\_

P/N:380745481 Rev:00



# Table of Contents

<b>Introduction</b> . . . . .	1	<b>Maintenance And Storage</b> . . . . .	27
<b>Safety Precautions</b> . . . . .	2	Maintenance Schedule . . . . .	27
<b>Unpacking the Generator</b> . . . . .	6	Engine Maintenance . . . . .	28
Parts Included . . . . .	7	Change Engine Oil . . . . .	28
<b>Removal of Shipping Supports</b> . . . . .	8	Air Filter Maintenance . . . . .	28
<b>Assembly</b> . . . . .	9	Spark Plug Maintenance . . . . .	29
Install the Wheel Kit . . . . .	9	Cleaning Fuel Strainer . . . . .	29
Install the Support Leg . . . . .	9	Inspect Muffler and Spark Arrester . . . . .	29
Battery Cable Connection . . . . .	10	Generator Maintenance . . . . .	30
<b>Controls and Features</b> . . . . .	11	Battery Replacement . . . . .	30
Generator . . . . .	11	Service and Storage . . . . .	31
Control Panel . . . . .	12	<b>Trouble Shooting</b> . . . . .	32
<b>Specifications</b> . . . . .	13	<b>Parts Diagram and Parts List</b> . . . . .	33
Add Engine Oil . . . . .	14	Generator Parts Diagram . . . . .	33
Low Oil Shutdown . . . . .	14	Engine Parts Diagram . . . . .	34
Add Fuel . . . . .	15	Parts List . . . . .	35
Operation at High Altitude . . . . .	17	<b>Service Information</b> . . . . .	37
Grounding . . . . .	18	<b>Warranty</b> . . . . .	37
Connecting to a Building's Electrical System . . . . .	18		
<b>Operation</b> . . . . .	19		
Generator Location . . . . .	19		
Surge Protection . . . . .	19		
Starting the Generator (Recoil Start-Gasoline) . . . . .	20		
Starting the Generator (Recoil Start-LPG) . . . . .	20		
Starting the Generator (Electric Start-Gasoline) . . . . .	22		
Starting the Generator (Electric Start-LPG) . . . . .	23		
Connecting Electrical Loads . . . . .	24		
Stopping the Engine . . . . .	24		
Indicator light - Battery Power Saving Mode . . . . .	25		
Low Oil Shutdown . . . . .	25		
Do Not Overload Generator . . . . .	25		

# INTRODUCTION

Thank you for purchasing a FIRMAN generator.

**This manual contains** safety information to make you aware of the hazards and risks associated with generator products and how to avoid them. This generator is designed and intended only for supplying electrical power for operating compatible electrical lighting, appliances, tools and motor loads, and is not intended for any other purpose. It is important that you read and understand these instructions thoroughly before attempting to start or operate this equipment.

**Save these original instructions for future reference.**

This manual covers operation and maintenance of the FIRMAN generators. All information in this publication is based on the latest production information available at the time of approval for printing. The manufacturer reserves the right to change, alter or otherwise improve the generator and this documentation at any time without prior change.

## Important Safety Information

The manufacturer cannot possibly anticipate every possible circumstance that might involve a hazard. The warnings in this manual and the tags and decals affixed to the unit are therefore not all-inclusive. If you use a procedure, work method or operating technique that the manufacturer does not specifically recommend you must satisfy yourself that it is safe for you and others. You must also make sure that the procedure work method or operating technique that you choose does not render the generator unsafe.

### SAFETY INFORMATION



#### DANGER

DANGER indicates a potentially hazardous situation which, if not avoided, WILL result in death or serious injury.



#### WARNING

WARNING indicates a potentially hazardous situation which, if not avoided, could result in death or serious injury.



#### CAUTION

CAUTION indicates a potentially hazardous situation which, if not avoided, may result in minor or moderate personal injury, or property damage.



Toxic Fumes



Risk of Electric Shock



Fire Hazard



Explosion Hazard



Hot Surface.  
Do Not Touch the Surface.



Rotating Parts Entanglement  
Hazard





Kickback



Operator's Manual

## SAFETY PRECAUTIONS

<b>⚠ DANGER</b>	
Using a generator indoors <b>CAN KILL YOU IN MINUTES</b> . Generator exhaust contains carbon monoxide. This is a poison you cannot see or smell.	
	
NEVER use inside a home or garage, EVEN IF doors and windows are open.	Only use <b>OUTSIDE</b> and far away from windows, doors, and vents.
Avoid other generator hazards. <b>READ MANUAL BEFORE USE.</b>	

### **⚠ WARNING**

#### **POISONOUS GAS HAZARD.**



Engine exhaust contains carbon monoxide, a poisonous gas that could kill you in minutes. You **CANNOT** smell it, see it, or taste it. Even if you do not smell exhaust fumes, you could still be exposed to carbon monoxide gas.

- Operate this product **ONLY** outside far away from windows, doors and vents to reduce the risk of carbon monoxide gas from accumulating and potentially being drawn towards occupied spaces.
- Install battery-operated carbon monoxide alarms or plug-in carbon monoxide alarms with battery back-up according to the manufacturer's instructions. Smoke alarms cannot detect carbon monoxide gas.
- **DO NOT** run this product inside homes, garages, basements, crawlspaces, sheds, or other partially-enclosed spaces even if using fans or opening doors and windows for ventilation. Carbon monoxide can quickly build up in these spaces and can linger for hours, even after this product has shut off.
- **ALWAYS** place this product downwind and point the engine exhaust away from occupied spaces. If you start to feel sick, dizzy, or weak while using this product, shut it off and get to fresh air **RIGHT AWAY**. See a doctor. You may have carbon monoxide poisoning.

### **⚠ WARNING**

The engine exhaust from this product contains chemicals known to the State of California to cause cancer, birth defects, or other reproductive harm.

### **⚠ WARNING**

Certain components in this product and related accessories contain chemicals known to the State of California to cause cancer, birth defects or other reproductive harm. Wash hands after handling.

- If you start to feel sick, dizzy or weak while using the portable generator, you may have carbon monoxide poisoning. Get out side to fresh air immediately and call 911 for emergency medical attention. Very high levels of CO can rapidly cause victims to lose consciousness before they can rescue themselves. **DO NOT** attempt to shut off the generator before moving to fresh air. Entering an enclosed space where a generator is or has been running may put you at greater risk of CO poisoning.

## CORRECT USAGE

### Example location to reduce risk of carbon monoxide poisoning

- ONLY use outside and downwind, far away from windows, doors and vents.
- Direct exhaust **AWAY** from windows, doors, and vents.

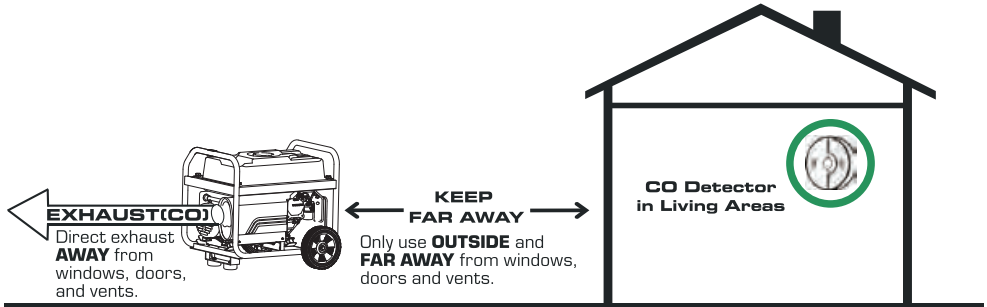

## INCORRECT USAGE

### Do not operate in any of the following locations:

- Near any door, window or vent
- Garage
- Basement
- Crawl Space
- Living Area
- Attic
- Entry Way
- Porch
- Mudroom

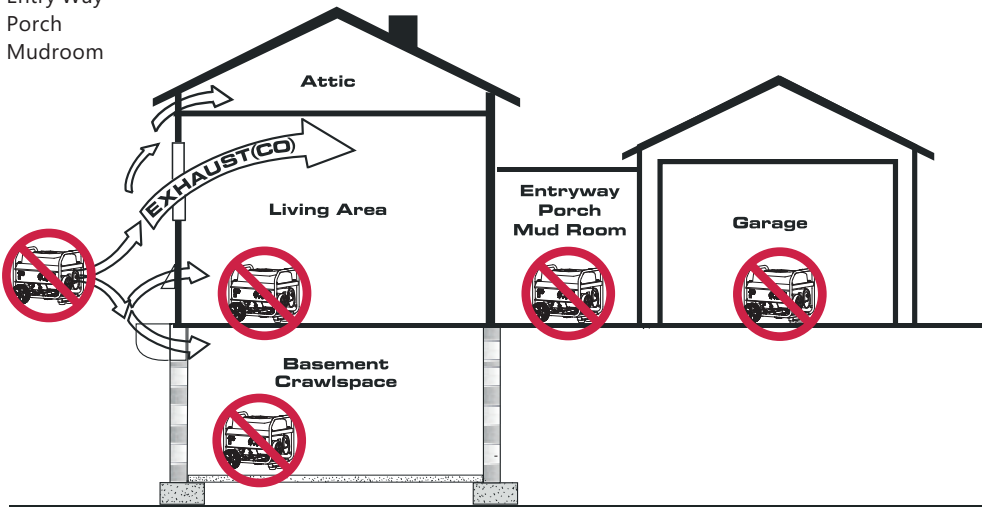

## **WARNING**



Starter cord kickback (rapid retraction) will pull hand and arm toward engine faster than you can let go which could cause broken bones, fractures, bruises, or sprains resulting in serious injury.

- When starting engine, pull cord slowly until resistance is felt and then pull rapidly to avoid kickback.
- **NEVER** start or stop engine with electrical devices plugged in and turned on.

## **WARNING**



Gasoline, gasoline vapors and liquid petroleum gas(LPG) are extremely flammable and explosive which could cause burns, fire, or explosion resulting in death or serious injury and/or property damage.

## **WHEN ADDING OR DRAINING GASOLINE**

- Turn generator engine OFF and let it cool at least 2 minutes before removing fuel cap. Loosen cap slowly to relieve pressure in tank.
- Fill or drain fuel tank outdoors.
- **DO NOT** overfill tank. Allow space for fuel expansion.
- If fuel spills, wait until it evaporates before starting engine.
- Keep fuel away from sparks, open flames, pilot lights, heat, and other ignition sources.
- Check fuel lines, tank, cap, and fittings frequently for cracks or leaks. Replace if necessary.
- **DO NOT** light a cigarette or smoke.

## **WHEN STARTING EQUIPMENT**

- Ensure spark plug, muffler, fuel cap, and air cleaner are in place.
- **DO NOT** crank engine with spark plug removed.

## **WHEN OPERATING EQUIPMENT**

- **DO NOT** operate this product inside any building, carport, porch, mobile equipment, marine applications, or enclosure.
- **DO NOT** tip engine or equipment at angle which causes fuel or oil to spill.
- **DO NOT** stop engine by moving choke control to "Start" position.

## **WHEN TRANSPORTING, MOVING OR REPAIRING EQUIPMENT**

- Transport/move/repair with fuel tank EMPTY or with fuel valve shut OFF.
- **DO NOT** tip engine or equipment at angle which causes fuel or oil to spill.
- Make certain that a LPG cylinder is not attached to generator and is securely stowed away.
- Disconnect spark plug wire.

## **WHEN STORING FUEL OR EQUIPMENT WITH FUEL IN TANK**

- Store away from furnaces, stoves, water heaters, clothes dryers, or other appliances that have pilot light or other ignition source because they could ignite fuel vapors.
- Do not store gasoline or LPG cylinder near furnaces, water heaters, or any other appliances that produce heat or have automatic ignitions.

## **WARNING**

- This generator does not meet U. S. Coast Guard Regulation 33CFR-183 and should not be used on marine applications.
- Failure to use the appropriate U. S. Coast Guard approved generator could result in death or serious injury and/or property damage.

## **WARNING**



Generator voltage could cause electrical shock or burn resulting in death or serious injury.

- Use approved transfer equipment, suitable for the intended use, to prevent backfeed by isolating generator from electric utility workers.

- When using generator for backup power, notify utility company.
- Use a ground fault circuit interrupter (GFCI) in any damp or highly conductive area, such as metal decking or steel work.
- **DO NOT** touch bare wires or receptacles.
- **DO NOT** use generator with electrical cords which are worn, frayed, bare or otherwise damaged.
- **DO NOT** operate generator in the rain or wet weather.
- **DO NOT** handle generator or electrical cords while standing in water, while barefoot, or while hands or feet are wet.
- **DO NOT** allow unqualified persons or children to operate or service generator.

### **WARNING**



Exhaust heat/gases could ignite combustibles, structures or damage fuel tank causing a fire, resulting in death or serious injury and/or property damage.

Contact with muffler area could cause burns resulting in serious injury.

- **DO NOT** touch hot parts and **AVOID** hot exhaust gases.
- Allow equipment to cool before touching.
- It is a violation of California Public Resource Code, Section 4442, to use or operate the engine on any forest-covered, brush-covered, or grass-covered land unless the exhaust system is equipped with a spark arrester, as defined in Section 4442, maintained in effective working order. Other states or federal jurisdictions may have similar laws. Contact the original equipment manufacturer, retailer, or dealer to obtain a spark arrester designed for the exhaust system installed on this engine.
- Replacement parts must be the same and installed in the same position as the original parts.

### **WARNING**



Unintentional sparking could cause fire or electric shock resulting in death or serious injury.

### **WHEN ADJUSTING OR MAKING REPAIRS TO YOUR GENERATOR**

- Disconnect the spark plug wire from the spark plug and place the wire where it cannot contact spark plug.

### **WHEN TESTING FOR ENGINE SPARK**

- Use approved spark plug tester.
- **DO NOT** check for spark with spark plug removed.

### **WARNING**



Starter and other rotating parts could entangle hands, hair, clothing, or accessories resulting in serious injury.

- **NEVER** operate generator without protective housing or covers.
- **DO NOT** wear loose clothing, jewelry or anything that could be caught in the starter or other rotating parts.
- Tie up long hair and remove jewelry.

### **CAUTION**

Excessively high operating speeds could result in minor injury. Excessively low operating speeds impose a heavy load.

- **DO NOT** tamper with governor spring, links or other parts to increase engine speed. Generator supplies correct rated frequency and voltage when running at governed speed.
- **DO NOT** modify generator in any way.

### **NOTE:**

Exceeding generators wattage/amperage capacity could damage generator and/or electrical devices connected to it.

- **DO NOT** exceed the generator's wattage amperage capacity.
- Start generator and let engine stabilize before connecting electrical loads.
- Connect electrical loads in OFF position, then turn ON for operation.
- Turn electrical loads OFF and disconnect from generator before stopping generator.



## NOTE:

Improper treatment of generator could damage it and shorten its life.

- Use generator only for intended uses.
- If you have questions about intended use, ask dealer or contact local service center.
- Operate generator only on level surfaces.
- DO NOT expose generator to excessive moisture, dust, dirt, or corrosive vapors.
- DO NOT insert any objects through cooling slots.
- If connected devices overheat, turn them off and disconnect them from generator.
- Shut off generator if:
  - Electrical output is lost.
  - Equipment sparks, smokes, or emits flames.
  - Unit vibrates excessively.

## WARNING

### Medical and Life Support Uses.

- In case of emergency, call 911 immediately.
- NEVER use this product to power life support devices or life support appliances.
- NEVER use this product to power medical devices or medical appliances.
- Inform your electricity provider immediately if you or anyone in your household depends on electrical equipment to live.
- Inform your electrical provider immediately if a loss of power would cause you or anyone in your household to experience a medical emergency.

## Fuel Safety

### Gasoline:

## DANGER

GASOLINE AND GASOLINE VAPORS ARE HIGHLY FLAMMABLE AND EXPLOSIVE.

Fire or explosion can cause severe burns or death. Unintentional startup can result in entanglement, traumatic amputation or laceration.

- Gasoline can cause a fire or explosion if ignited.
- Gasoline is a liquid fuel but it's vapors can ignite.

- Gasoline is a skin irritant and needs to be cleaned up immediately if spilled on skin or clothes.
- Gasoline has a distinctive odor, this will help detect potential leaks quickly.
- In any gasoline fire, flames should not be extinguished unless by doing so the fuel supply valve can be turned OFF. This is because if a fire is extinguished and a supply of fuel is not turned OFF, then an explosion hazard could be created.
- Gasoline expands or contracts with ambient temperatures. Never fill the gasoline tank to full capacity, as gasoline needs room to expand if temperatures rise.

### Liquid Petroleum Gas (LPG/Propane):

This generator is dual fuel and capable of running with both gasoline and Liquid Petroleum Gas (LPG/Propane).

## DANGER

- Liquid Petroleum Gas (LPG) is highly flammable and explosive. Fire or explosion can cause severe burns or death.
- Do not use or store LPG cylinder in a building, garage or enclosed area.
- Do not check for leaks with a lighted match or flame.
- The LPG cylinder valve should be fully closed when the generator is not in use or is running with gasoline.
- If you smell gas: close off the gas supply. Make sure there is no leak before using the generator.

## WARNING

- Device used for handling LPG must be installed and used in strict conformance with NFPA 58 (Liquefied Petroleum Gas Code) and NFPA 54 (National Fuel Gas) and all other codes, regulations and manufacturer recommendations.
- Never use a gas container, LPG connector hose, LPG cylinder or any other fuel item that is damaged or appears damaged.
- The LPG cylinder valve should be fully closed when the generator is not in use or is running with gasoline.
- The regulator/hose assembly and cylinder valve must be inspected before each use for leaks or sign of damages.

- If you smell gas: close off the gas supply. Spray a soapy water solution to check all connections for leaks before attempting to use generator. Contact a qualified technician to inspect and repair the LPG system if a leak found before using the generator.

**⚠ CAUTION**

- LPG under pressure is highly flammable and can cause a fire or explosion if ignited.
- LPG is heavier than air and can accumulate in confined spaces and low places in the event of a leak.
- LPG has a distinctive odor to help detect potential leaks.
- Do not allow children to tamper or play with the LPG cylinder.
- In the event of an LPG fire, flames should not be extinguished unless by doing so the fuel supply valve can be turned off. If the fire is extinguished and a supply of fuel is not turned off, an explosion hazard greater than the fire hazard could be created.
- Keep a fire extinguisher near the generator all the time.
- Always keep the LPG cylinder in an upright position.
- Do not subject LPG cylinder to excessive heat.
- Contact with liquid contents of the cylinder will cause freeze burns to the skin.
- An LPG cylinder not connected for use shall not be stored in the vicinity of the generator.
- When transporting and storing, turn off the cylinder valve and fuel selector switch, and disconnect the cylinder.

**UNPACKING THE GENERATOR**

- Open carton and Remove packaging materials.
- Remove generator, accessories boxes, and literature from carton. If any items are missing or damaged, contact our product service department at 1-844-347-6261.

**Parts Included**

Your gasoline powered generator ships with the following parts:

1. Axle pin . . . . .	2
2. 10.0" in. Wheel . . . . .	2
3. Flat Washer. . . . .	2
4. Cotter pin. . . . .	2
5. Engine Oil(Bottle) . . . . .	1
6. Oil Funnel . . . . .	1
7. Wrench for Spark plug . . . . .	1
8. Double Open wrench (10mm & 12mm) . . . . .	2
9. Support Leg with Vibration Mounts . . . . .	1
10. Flange Bolt (M8x16 for Support Leg) . . . . .	2
11. Flange Lock Nut (M8) . . . . .	4
12. Flange Bolt M6X25. . . . .	2
13. Rubber Support. . . . .	2
14. Flange Lock Nut (M6) . . . . .	4
15. Handle . . . . .	1
16. LPG Hose With Regulator 5 ft. (1.5 m) . . . . .	1
17. Manual. . . . .	1
18. Quick Reference Guide . . . . .	1

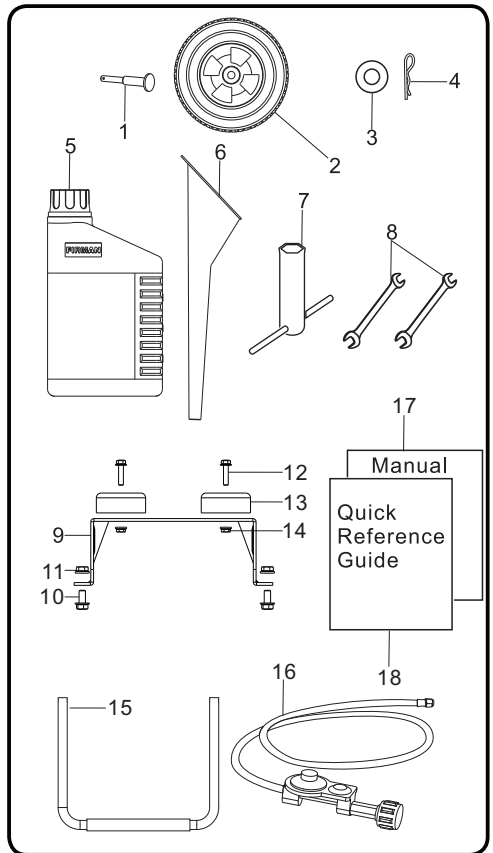

## ASSEMBLY

The generator requires some assembly prior to usage. If problems arise when assembling the generator, call 1-844-347-6261.

### Install the Wheel Kit

#### CAUTION

The wheel kit is not intended for over-the-road use.

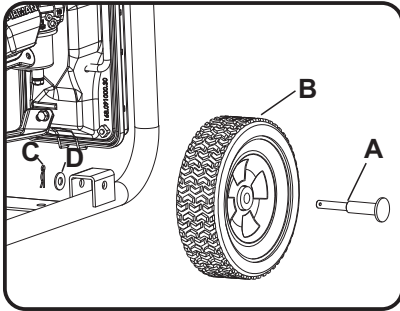

1. Before adding wheels, tip the generator on its side.
2. Slide the axle pin **A** through the wheel **B**.
3. Slide the axle pin **A** through the mount point on the frame and flat washer **D**.
4. Secure the wheel and axle pin with the cotter pin **C**.
5. Repeat steps 2-4 to attach another wheel.

### Install the Support Leg

1. Attach the rubber support (**H**) to the support leg (**G**) with flange bolt (**I**) (M6X25) and flange lock nut(**J**) (M6).
2. Attach the support leg (**G**) to the generator frame with flange bolt (**E**) (M8X16) and flange lock nut(**F**) (M8).
3. Tip the generator slowly so that it rests on the wheels and support leg.
4. Tighten bolt **E** and nut **F** with provide wrenches.

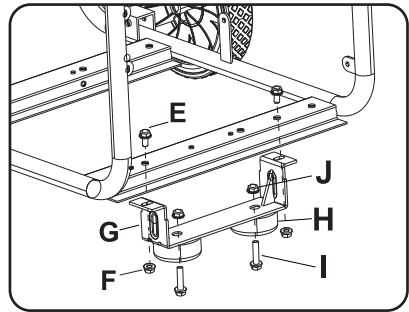

---

## Battery Cable Connection

You will need to use 8mm box wrenches to connect the battery cables to battery.

### NOTE:

The generator comes equipped with the positive red cable(red cable) already attached.

1. Verify the positive (+) battery cable (red boot) is securely tightened to the positive (+) battery post. Make sure boot is over battery post.
2. Remove bolt M5X12 and M5 nut from black cable ring.

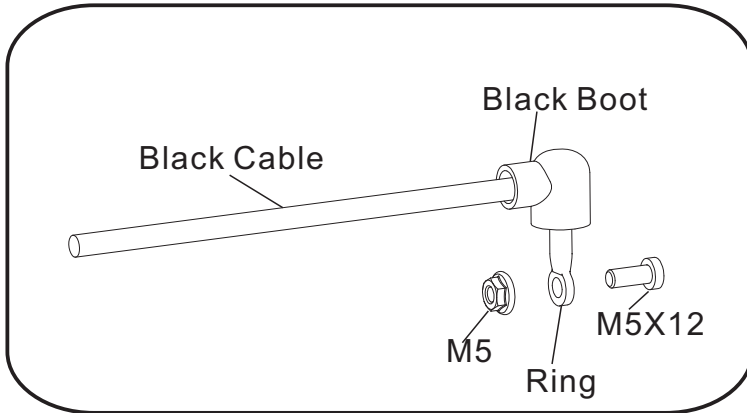

3. Remove vinyl cap from the negative(-) battery post. Locate negative (-) black cable and route to the negative(-) battery post. Tight the cable with bolt M5X12 and M5 nut. Cover the post with black boot.

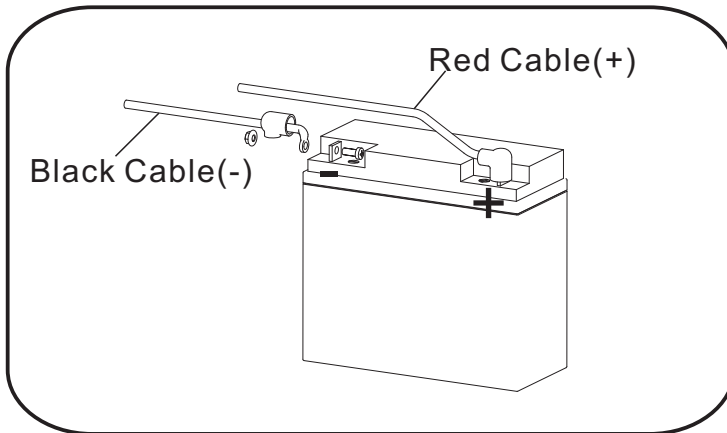

## CONTROLS AND FEATURES

### Generator

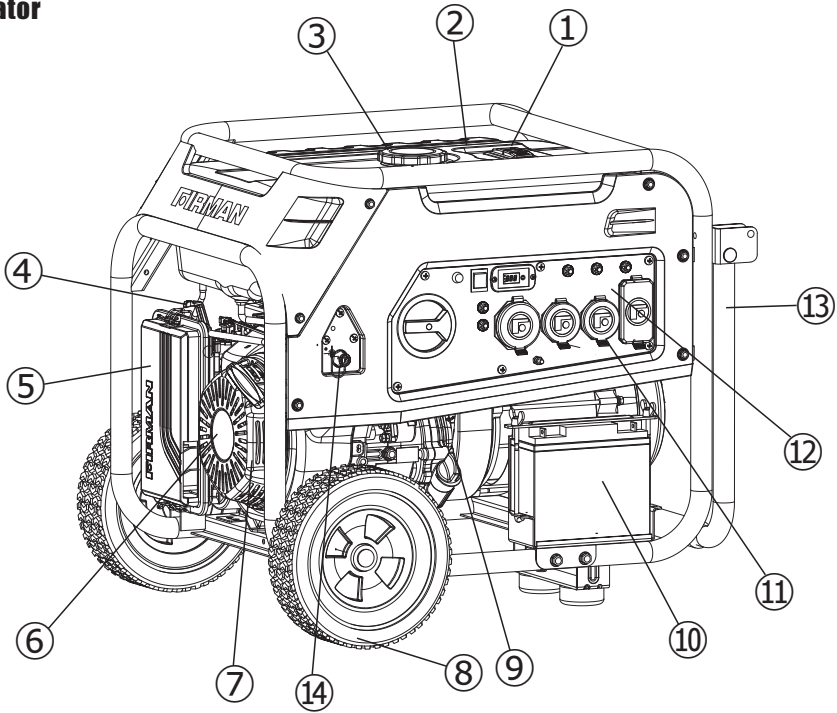

**1- Fuel Gauge**

**2- 8.0 Gallon Capacity Fuel Tank**

**3- Fuel Cap**

**4- Choke Lever(behind air filter box)**

**5- Air Filter**

**6- 439cc FIRMAN OHV Engine**

**7- Recoil Starter**

**8- 10.0" Flat Free Wheel**

**9- Oil Filler Cap**

**10- Battery**

**11- Outlet Cover**

**12- Control Panel**

**13- Handle**

**14- LPG Hose Connector(Inlet)**

\*We are always working to improve our products. Therefore, the enclosed product may differ slightly from the image on this page.

# Control Panel

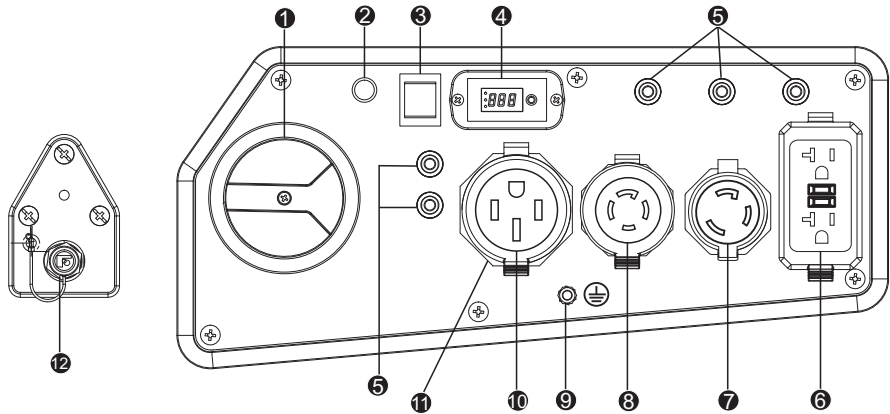

**NOTE: Total power drawn from all receptacles must not exceed the name plate rating.**

- 1 Fuel Selector Switch** – Used to select and turn on gasoline or LPG fuel source.
- 2 Indicator Light**

When the fuel selector switch is turned to the “GAS” or “LPG” position, the indicator light will become **RED** up to **4 minutes**(before goes off). Starting the engine successfully during these **4 minutes** will turn the indicator light **GREEN**. **MUST HAVE SOLID RED INDICATOR LIGHT TO BE ABLE TO START THE GENERATOR. THE GENERATOR CANNOT BE STARTED DURING BATTERY POWER SAVING MODE UNLESS THE FUEL SELECTOR SWITCH IS TURNED TO THE “OFF” POSITION AND THEN TURNED BACK TO THE “GAS” OR “LPG” POSITION. See Indicator light - Battery power Saving Mode section for more information.**
- 3 Engine Start Switch** – Used to start engine from the starter motor(Electric start model only). To start engine, press and hold the switch in the “**START**”(II) position, the engine will crank and attempt to start. When the engine starts, release the switch to the “**RUN**”(I) position.
- 4 3-1 Data-Minder(Multi-Meter)** – Push the SELECT button to show the Voltage, Hertz and running hours.
- 5 Circuit Breakers** – The receptacles are protected by an AC circuit protector. If the generator is overloaded or an external short circuit occurs the circuit protector will trip. If this occurs, disconnect all electrical loads and try to determine the cause of the problem before attempting to use the generator again. If overloading causes the circuit protector to trip, reduce the load. **Note: Continuous tripping of the circuit protector may cause damage to generator or equipment.** The circuit protector may be reset by pushing the button of the protector.
- 6 120V, 20A Duplex GFCI (Ground Fault Circuit Interrupter)** – (NEMA 5-20R)

This receptacle is rated so that a total of 20 amps may be drawn regardless of whether both halves or just one receptacle is used.

Ground Fault Circuit Interrupter conforms to UL 943, and NEC requirements. This device protects you against hazardous electrical shock that may be caused if your body becomes a path through which electricity travels to reach ground. This could happen when you touch an appliance or cord that is “live” through faulty mechanism, damp or worn insulation, etc.
- 7 120V, 30A Twist-Lock** – (NEMA L5-30R)

Maximum full load 30 Amp current may be drawn from this 120 Volt receptacle.
- 8 120/240V, 30A Twist-Lock** – (NEMA L14-30R)

Maximum 30 Amp current maybe drawn from this 120/240 Volt receptacle.

9 **Ground Terminal** – Consult an electrician for local grounding regulations.

10 **120/240V, 50A** – (NEMA 14-50R)  
Supplies electrical power for the operation of 120/240 Volt AC, 50Amp, single phase. Maximum full load current may be drawn from this receptacle. If other receptacles are used at the same time, total power used must be kept within nameplate.

11 **Outlet Cover** - Protect the receptacles from dust and debris.

12 **LPG Hose Connector(Inlet)** – Used to connect LPG hose to generator.

## 120VAC, 20AMP GFCI RECEPTACLE

This unit is equipped with a ground fault circuit interrupter (GFCI). This device meets applicable federal, state and local codes .

A GFCI receptacle is different from conventional receptacles. In the event of a ground fault, a GFCI will trip and quickly stop the flow of electricity to prevent serious injury.

Definition: Instead of following its normal safe path, electricity passes through a persons body to reach the ground. For example, a defective appliance can cause a ground fault.

A GFCI receptacle does NOT protect against circuit overloads, short circuits, or shocks. For example, electric shock can still occur if a person touches charged electrical wires while standing on a non-conducting surface, such as a wood floor.

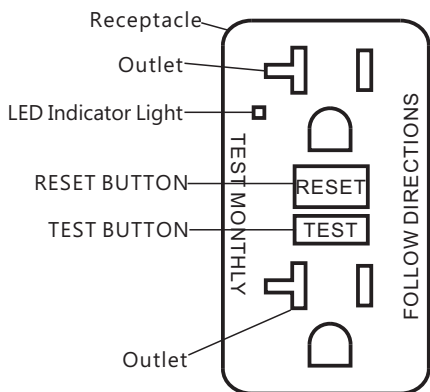

Testing the GFCI: Test the GFCI outlet every month as follows:

1. Plug a test lamp into the receptacle.
2. Start the generator, the test lamp should be on.
3. Press the "Test" button located on the front of the receptacle to trip the device.
4. This should stop the flow of electricity making the lamp shut off. The GFCI's indicator light comes off.
5. To restore the flow of electricity, press the "RESET" button on the front of the receptacle. If the GFCI does not perform in this manner, do not use the receptacle. Contact a local service dealer or costumer service.
6. This outlet is protected against overload by a 20A push-to-reset circuit breaker. Use the outlet to power 120V AC, single-phase, 60 Hz, electrical loads requiring up to a combined 2400 watts (2.4 kW) or 20 amps of current.

## SELF-TEST OPERATION

A Self-Test GFCI receptacle has all the features of a conventional GFCI receptacle. In addition, this receptacle tests itself periodically to confirm the GFCI electronics are functional. The Indicator Light will be solid green when the GFCI is powered from Line side and working correctly.

**Self-Test Indications:** If the Indicator Light is solid orange or flashing red a problem may exist. Press the TEST button to trip the GFCI. If unable to Reset, replace the GFCI.

## SPECIFICATIONS

Model	H08051
Starting Watts	10000(GASOLINE)/9050(LPG)
Running Watts	8000(GASOLINE)/7250(LPG)
Rated AC Voltage	120/240V
Rated Frequency	60Hz
Phase	Single
Voltage Regulator	AVR
Power Factor	1
Alternator Type	Brushed
Engine	FIRMAN
Engine Type	Single Cylinder, 4-Stroke OHV Air Cooled
Displacement	439cc
Low Oil Shutdown	Yes
Ignition System	Breakless Ignition Type, Flywheel Magneto
Starting System	Recoil/Electric Start
Fuel	Unleaded Automotive Gasoline/LPG
Capacity Fuel Tank	8.0 Gallon
Lubricating Oil Capacity	37.2 oz(1.1L)
Carburetor Type	Float
Air Cleaner	Polyurethane Type
P.T.O. Shaft Rotation	Counter Clockwise (Facing P.T.O.)
Oil Type	See "Add Engine Oil" Section
Spark Plug	TORCH F6RTC/NGK BPR6ES/CHAMPION RN9YC

### AN IMPORTANT MESSAGE ABOUT TEMPERATURE:

Your Firman Power Equipment product is designed and rated for continuous operation at ambient temperatures up to 40°C (104°F). When your product is needed, your product may be operated at temperatures ranging from -15°C (5°F) to 50°C (122°F) for short periods. If the product is exposed to temperatures outside this range during storage, it should be brought back within this range before operation. In any event, the product must always be operated outdoors, in a well-ventilated area and away from doors, windows and other vents.

- When operated above 77°F(25°C) there may be a decrease in power.
- Maximum wattage and current are subject to and limited by such factors as fuel BTU content ambient temperature, altitude, engine condition and etc. Maximum power decreases about 3.5% for each 1,000 feet above sea level; and will also decrease about 1% for each 10°F(-12.2°C) above 60°F(16°C) ambient temperature.



## ADD ENGINE OIL

### ⚠ CAUTION

DO NOT attempt to crank or start the engine before it has been properly filled with the recommended type and amount of oil. Damage to the generator as a result of failure to follow these instructions will void your warranty.

### NOTE:

The recommended oil type is 10W-30 automotive oil. However outdoor temperatures determine the space proper oil viscosity for the engine. Use the chart to select the best for the outdoor temperature range expected.

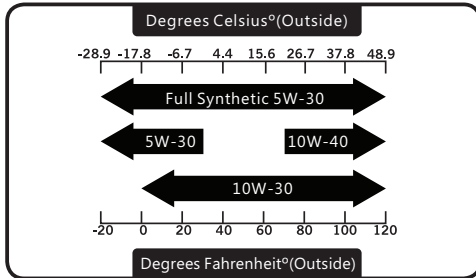

1. Place generator on a flat, level surface.
2. Clean area around oil fill and remove yellow oil fill cap/dipstick.
3. Wipe dipstick clean.

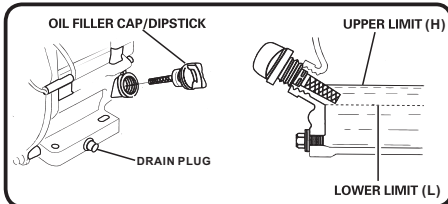
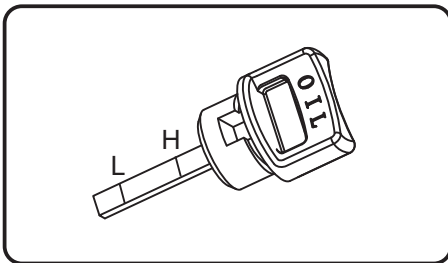

4. Using oil funnel, slowly pour contents of provided oil bottle into oil fill opening to the "H" mark on dipstick. Be careful do not overfill. Overfilling with oil could cause the engine to not start or hard starting.

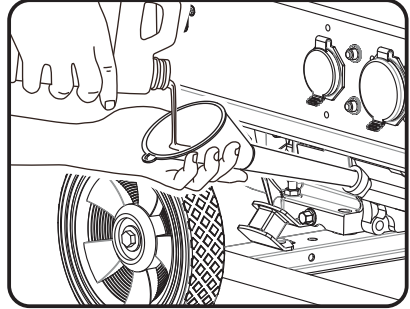

5. Replace oil fill cap/dipstick and fully tighten.
6. Oil level should be checked prior to each use or at least every 8 hours of operation. Keep oil level maintained.

### ⚠ CAUTION

The engine is equipped with a low oil shut-off and will stop when the oil level in the crankcase falls below the threshold level.

### NOTE:

We consider the first 5 hours of run time to be the break-in period for the unit. During the break in period stay at or below 50% of the running watt rating and vary the load occasionally to allow stator windings to heat and cool. Adjusting the load will also cause engine speed to vary and help seat piston rings.

### Low Oil Shutdown

The unit is equipped with a low oil shutdown. If the oil level becomes lower than required, the sensor will activate a warning device or stop the engine.

If generator shuts off and the oil level is within specifications, check to see if generator is sitting at an angle that forces oil to shift. Place on an even surface to correct this. If engine fails to start, the oil level may not be sufficient to deactivate low oil level switch. Make sure the sump is completely full of oil.

## ADD FUEL

### 1. Gasoline

Fuel must meet these requirements:

- Clean, fresh, unleaded gasoline.
- Use regular UNLEADED gasoline with the generator engine with a minimum 87 octane / 87 AKI (91 RON).

For high altitude use, see "Operation at High Altitude".

- Do not use gasoline with more than 10% alcohol such as E85 or ethanol.

**NOTE:** Avoid generator damage.

Failure to follow Operator's Manual for fuel recommendations voids warranty.

- DO NOT use unapproved gasoline such as E85.
- DO NOT mix oil in gasoline.
- DO NOT modify engine to run on alternate fuels.

#### WARNING



Fuel and its vapors are extremely flammable and explosive which could cause burns, fire or explosion resulting in death, serious injury and/or property damage.

- Fill fuel tank outdoors.



DO NOT overfill tank. Allow space for fuel expansion. If the tank is overfilled, fuel can overflow onto a hot engine and cause fire or explosion. Wipe up any spilled fuel immediately.

- If fuel spills, wait until it evaporates before starting engine.
- Keep fuel away from sparks, open flames, pilot lights, heat, and other ignition sources.
- Check fuel lines, tank, cap and fittings frequently for cracks or leaks. Replace if necessary.



DO NOT light a cigarette or smoke when filling the fuel tank.

1. Clean area around fuel fill cap, remove cap.
2. Slowly add unleaded fuel to fuel tank. Be careful not to fill above the red fuel level indicator. This allows adequate space for fuel expansion.
3. Install fuel cap and let any spilled fuel evaporate before starting engine or wipe up any spilled gasoline.

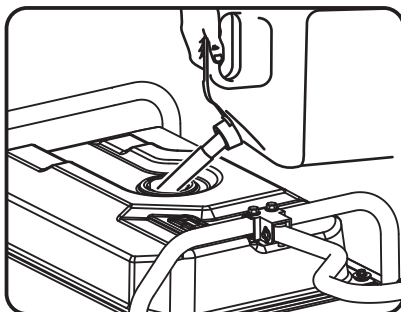

#### CAUTION

- Slowly add unleaded gasoline to fuel tank.
- Do not overfill tank.
- Do not fill above the red line indicator. This will allow expansion in hot weather and prevent overflow.



### 2-Connecting Liquid Petroleum Gas (LPG/Propane) Cylinder

#### DANGER

- Liquid Petroleum Gas (LPG) is highly flammable and explosive. Fire or explosion can cause severe burns or death.
- Do not place the LPG cylinder in the path of muffler outlet.
- Do not use or store LPG cylinder in a building, garage or enclosed area.
- Do not check for leaks with a lighted match or flame.
- The LPG cylinder valve should be fully closed when the generator is not in use or is running with gasoline.
- If you smell gas: close off the gas supply. Make sure there is no leak before using the generator.

## **⚠ WARNING**

- Device used for handling LPG must be installed and used in strict conformance with NFPA 58 (Liquefied Petroleum Gas Code) and NFPA 54 (National Fuel Gas) and all other codes, regulations and manufacturer recommendations.
- Never use a gas container, LPG connector hose, LPG cylinder or any other fuel item that is damaged or appears damaged.
- The LPG cylinder valve should be fully closed when the generator is not in use or is running with gasoline.
- The regulator/hose assembly and cylinder valve must be inspected before each use for leaks or sign of damages.
- If you smell gas: close off the gas supply. Spray a soapy water solution to check all connections for leaks before attempting to use generator. Contact a qualified technician to inspect and repair the LPG system if a leak found before using the generator.
- Use only 20 or 30 lb capacity cylinders with Type 1, right hand Acme threads with this generator. Verify the re-qualification date on the tank has not expired. Do not use rusted or damaged cylinders.
- All new cylinders must be purged of air and moisture prior to filling. Used cylinders that have not been plugged or kept closed must also be purged. The purging process should be done by your propane gas supplier.
- Do not connect or disconnect the LPG cylinder in enclosed area.
- Do not install or replace the LPG cylinder near open flames, pilot lights, or sparking electrical equipment such as power tools, welders and grinders.

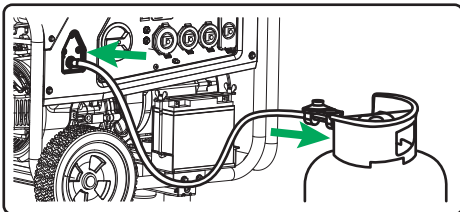

- Attach the LPG regulator/hose assembly (included) to the LPG hose connector (inlet) on the control panel of the generator. Tighten the nut with 19 mm or adjustable wrench.
- Remove the safety plug or cap from the cylinder valve.
- Attach the other end of the LPG regulator/hose assembly to the cylinder valve. Tighten the nut by hand clockwise to a positive stop. Do not use a wrench to tighten. Use of wrench may damage quick closing coupling nut and result in a hazardous condition.
- Do not use tape or any type sealant to seal the LPG hose connections.
- You must use the supplied regulator/hose assembly for safe operation.
- Always position the cylinder so the connection between the valve and the regulator won't cause bends or kinks in the hose.
- Spray a soapy water solution (one part liquid detergent and one part water) to check all connections for leaks before attempting to use generator. Slowly open the cylinder valve. A leak exists if bubbles appear or grow larger in size or number. This must be corrected before using the generator. Contact your local Authorized Service Facility for assistance. Do not attempt to make repairs yourself.
- Do not check for leaks with a lighted match or flame.
- Do not light or smoke cigarettes.
- Check the fuel system periodically for leaks or signs of damages.

## **⚠ CAUTION**

- LPG under pressure is highly flammable and can cause a fire or explosion if ignited.
- LPG is heavier than air and can accumulate in confined spaces and low places in the event of a leak.
- LPG has a distinctive odor to help detect potential leaks.
- Do not allow children to tamper or play with the LPG cylinder.

- In the event of an LPG fire, flames should not be extinguished unless by doing so the fuel supply valve can be turned off. If the fire is extinguished and a supply of fuel is not turned off, an explosion hazard greater than the fire hazard could be created.
- Keep a fire extinguisher near the generator all the time.
- Always keep the LPG cylinder in an upright position.
- Do not subject LPG cylinder to excessive heat.
- Contact with liquid contents of the cylinder will cause freeze burns to the skin.
- An LPG cylinder not connected for use shall not be stored in the vicinity of the generator.
- When transporting and storing, turn off the cylinder valve and fuel selector switch, and disconnect the cylinder.

### 3-Permanent Connection to a large Propane supply tank:

In the instance that you would need to connect your generator to a large propane Supply tank, larger than 20 or 30 lb DOT cylinder, it is recommended to contact your Gas Equipment Company. Various equipment for use with LPG, is required for proper conformance to all NFPA regulations. Your Gas Equipment Company can help you select and install the proper regulator, fittings and connections to meet all the Codes and manufacturer regulations. Each installation may be different and will require proper equipment. Contact your Gas Equipment Company to assure that you are meeting all NFPA 58 (Liquefied Petroleum Gas Code) and NFPA 54 (National Fuel Gas) Codes.

### Operation at High Altitude

At altitudes over 5,000 feet(1524 meters), a minimum 85 octane / 85 AKI (89 RON) gasoline is acceptable.

The density of air at high altitude is lower than at sea level. Engine power is reduced as the air mass and air-fuel ratio decrease. Engine power and generator output will be reduced approximately 3.5% for every 1000 feet of elevation above sea level. This is a natural trend and cannot be changed by adjusting the engine. At high altitudes increased exhaust emissions can also result due to the increased enrichment of the air fuel ratio.

Other high altitude issues can include hard starting, increased fuel consumption and spark plug fouling. To alleviate high altitude issues other than the natural power loss, **FIRMAN** can provide a high altitude carburetor main jet. The alternative main jet and installation instructions can be obtained by contacting Customer Support. Installation instructions are also available in the Technical Bulletin area of the FIRMAN internet site. The part number and recommended minimum altitude for the application of the high altitude carburetor main jet is listed in the table below.

	439cc	Altitude
Altitude main jet 1	380717004	3000-6000Feet
Altitude main jet 2	380717005	6000-8000Feet

### WARNING

Operation using the alternative main jet at elevations lower than the recommended minimum altitude can damage the engine. For operation at lower elevations, the standard main jet must be used. Operating the engine with the wrong engine configuration at a given altitude may increase its emissions and decrease fuel efficiency and performance.

---

---

## Grounding

The National Electric Code requires your generator must be properly connected to an appropriate ground to help prevent electric shock.

### **WARNING**



Failure to properly ground the generator can result in electric shock.

A ground terminal connected to the frame of the generator has been provided on the control panel. For remote grounding, connect of a length of heavy gauge (12 AWG minimum) copper wire between the generator ground terminal and a copper rod driven into the ground. We strongly recommend that you consult with a qualified electrician to ensure compliance with local electrical codes.

**THERE IS A PERMANENT CONDUCTOR BETWEEN THE GENERATOR (STATOR WINDING) AND THE FRAME.**

## Connecting to a Building's Electrical System

Connections for standby power to a building's electrical system must be made by a qualified electrician. The connection must isolate the generator power from utility power or other alternative power sources and must comply with all applicable laws and electrical codes.

### **WARNING**



Generator voltage could cause electrical shock or burn resulting in death or serious injury.

- Use approved transfer equipment to prevent backfeed by isolating generator from electric utility workers.
- When using generator for backup power, notify utility company.
- Use a ground fault circuit interrupter (GFCI) in any damp or highly conductive area, such as metal decking or steel work.
- DO NOT touch bare wires or receptacles.
- DO NOT use generator with electrical cords which are worn, frayed, bare or otherwise damaged.
- DO NOT operate generator in the rain or wet weather.
- DO NOT handle generator or electrical cords while standing in water, while barefoot, or while hands or feet are wet.
- DO NOT allow unqualified persons or children to operate or service generator.

## 5. OPERATION

### Generator Location

#### WARNING

Make sure you review each warning in order to prevent fire hazard.

- Keep area clear of inflammables or other hazardous materials.
- Select a site that is dry, well ventilated and protected from the weather.
- Keep exhaust pipe clear of foreign objects.
- Keep generator away from open flame.
- Keep generator on a stable and level surface.

#### CAUTION

Tilting can cause fuel spillage.

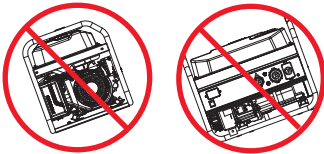

- Do not block generator air vents with paper or other material.

#### DANGER

Using a generator indoors **CAN KILL YOU IN MINUTES.**

Generator exhaust contains carbon monoxide. This is a poison you cannot see or smell.



**NEVER** use inside a home or garage, **EVEN IF** doors and windows are open.



**Only use OUTSIDE** and far away from windows, doors, and vents.

Avoid other generator hazards.  
**READ MANUAL BEFORE USE.**

#### WARNING

### POISONOUS GAS HAZARD.



Engine exhaust contains carbon monoxide, a poisonous gas that could kill you in minutes. You **CANNOT** smell it, see it, or taste it. Even if you do not smell exhaust fumes, you could still be exposed to carbon monoxide gas.

- Operate this product **ONLY** outside far away from windows, doors and vents to reduce the risk of carbon monoxide gas from accumulating and potentially being drawn towards occupied spaces.
- Install battery-operated carbon monoxide alarms or plug-in carbon monoxide alarms with battery back-up according to the manufacturer's instructions. Smoke alarms cannot detect carbon monoxide gas.
- **DO NOT** run this product inside homes, garages, basements, crawlspaces, sheds, or other partially-enclosed spaces even if using fans or opening doors and windows for ventilation. Carbon monoxide can quickly build up in these spaces and can linger for hours, even after this product has shut off.
- **ALWAYS** place this product downwind and point the engine exhaust away from occupied spaces. If you start to feel sick, dizzy, or weak while using this product, shut it off and get to fresh air **RIGHT AWAY**. See a doctor. You may have carbon monoxide poisoning.

### Surge Protection

#### CAUTION

Voltage fluctuation may impair the proper functioning of sensitive electronic equipment.

Electronic devices, including computers and many programmable appliances use components that are designed to operate within a narrow voltage range and may be affected by momentary voltage fluctuations. While there is no way to prevent voltage fluctuations, you can take steps to protect sensitive electronic equipment.

Install UL1449, CSA-listed, plug-in surge suppressors on the outlets feeding your sensitive equipment. Surge suppressors come in single- or multi-outlet styles. They're designed to protect against virtually all short-duration voltage fluctuations.

## Starting the Generator (Recoil Start-Gasoline)

1. Before starting the generator, check for loose or missing parts and for any damage which may have occurred during shipment.
2. Check oil level and fuel(Gasoline).

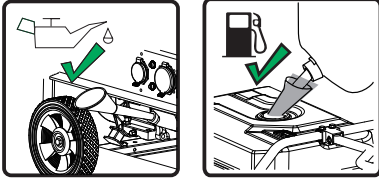

3. Make sure the LPG cylinder knob is fully closed.



4. Turn the fuel selector switch to "GAS" position.

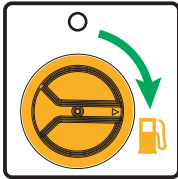

**NOTE:** When the fuel selector switch is turned to the "GAS" position, the indicator light will become **RED** up to **4 minutes**(before goes off). Starting the engine successfully during these **4 minutes** will turn the indicator light **GREEN**.

5. Disconnect all electrical loads from the generator. Never start or stop the generator with electrical devices plugged in or turned on.

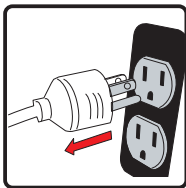

6. Move choke lever located on engine to "START" position.



7. Pull the starter cord slowly until resistance is felt and then pull rapidly.

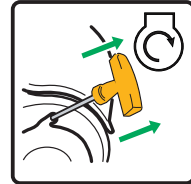

**REMINDER:** MUST HAVE **SOLID RED INDICATOR LIGHT** TO BE ABLE TO START THE GENERATOR. THE GENERATOR CANNOT BE STARTED DURING **BATTERY POWER SAVING MODE** UNLESS THE FUEL SELECTOR SWITCH IS TURNED TO THE "OFF" POSITION AND THEN TURNED BACK TO THE "GAS" POSITION. See **Indicator light-Battery power Saving Mode** section for more information.

8. Do not over-choke. As soon as engine starts and warms up, move the choke lever to the "RUN" position.

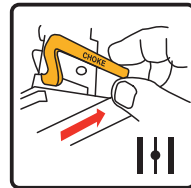

9. Allow generator to run at no load for few minutes upon each initial start-up to permit engine and generator to stabilize.

## Starting the Generator (Recoil Start-LPG)

1. Before starting the generator, check for loose or missing parts and for any damage which may have occurred during shipment.
2. Check oil level .

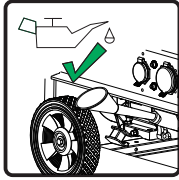

3. Connect the regulator to both LPG cylinder and generator.

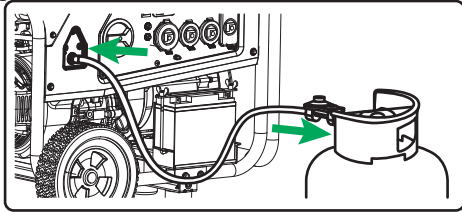

**NOTE:** Do not place the LPG cylinder in the path of muffler outlet.

4. Fully open the LPG cylinder knob.

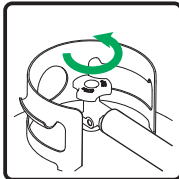

5. Turn the fuel selector switch to "LPG" position.

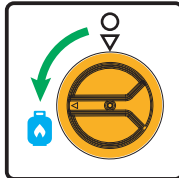

**NOTE:** When the fuel selector switch is turned to the "LPG" position, the indicator light will become **RED** up to **4 minutes** (before goes off). Starting the engine successfully during these **4 minutes** will turn the indicator light **GREEN**.

6. Disconnect all electrical loads from the generator. Never start or stop the generator with electrical devices plugged in or turned on.

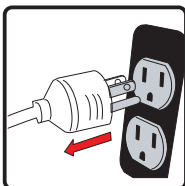

7. Move choke lever located on engine to "START" position.



8. **PULL-TO-PRIME:**

Pull the starter cord 1-2 times. Pull slowly until resistance is felt and then pull rapidly.

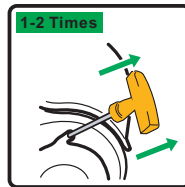

9. Move the choke lever to the "RUN" position.

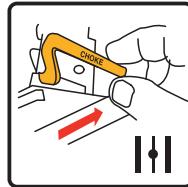

10. **PULL-TO-RUN:**

Pull the starter cord slowly until resistance is felt and pull rapidly to run the unit.

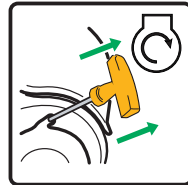

If the engine fails to start in 1-2 pulls with choke in the "RUN" position, then move choke lever to "START" position and repeat the "PULL-TO-PRIME" step.

11. Allow generator to run at no load for few minutes upon each initial start-up to permit engine and generator to stabilize.

**REMINDER: MUST HAVE SOLID RED INDICATOR LIGHT TO BE ABLE TO START THE GENERATOR. THE GENERATOR CANNOT BE STARTED DURING BATTERY POWER SAVING MODE UNLESS**



THE FUEL SELECTOR SWITCH IS TURNED TO THE "OFF" POSITION AND THEN TURNED BACK TO THE "LPG" POSITION.

See **Indicator light-Battery power Saving**

**Mode** section for more information.

**WARNING**



Starter cord kickback (rapid retraction) will pull hand and arm toward engine faster than you can let go which could cause broken bones, fractures, bruises, or sprains resulting in serious injury.

When starting engine, pull cord slowly until resistance is felt and then pull rapidly to avoid kickback.

**NOTE:**

Keep choke lever in "START" position for only 1 pull of the recoil starter. After first pull, move choke lever to the "RUN" position for up to the next 3 pulls of the recoil starter. Too much choke leads to sparkplug fouling/engine flooding due to the lack of incoming air. This will cause the engine not to start.

**NOTE:**

If engine starts after 3 pulls but fails to run, or if unit shuts down during operation, make sure unit is on a level surface and check for proper oil level in crankcase. This unit may be equipped with a low oil protection device. If so, oil must be at proper level for engine to start.

**Starting the Generator (Electric Start-Gasoline)**

1. Before starting the generator, check for loose or missing parts and for any damage which may have occurred during shipment.
2. Check oil level and fuel (Gasoline).

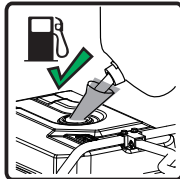
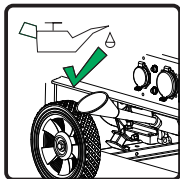

3. Make sure the LPG cylinder knob is fully closed.



4. Turn the fuel selector switch to "GAS" position.

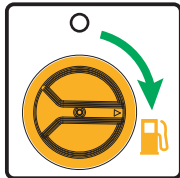

**NOTE:** When the fuel selector switch is turned to the "GAS" position, the indicator light will become **RED** up to **4 minutes** (before goes off). Starting the engine successfully during these **4 minutes** will turn the indicator light **GREEN**.

5. Disconnect all electrical loads from the generator. Never start or stop the generator with electrical devices plugged in or turned on.

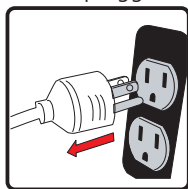

6. Move choke lever located on engine to "START" position.



7. Flip the engine switch to the "START" (II) position for few seconds and then release.



**REMINDER: MUST HAVE SOLID RED INDICATOR LIGHT TO BE ABLE TO START THE GENERATOR. THE GENERATOR CANNOT BE STARTED DURING BATTERY POWER SAVING MODE UNLESS THE FUEL SELECTOR SWITCH IS TURNED TO THE "OFF" POSITION AND THEN TURNED BACK TO THE "GAS" POSITION. See Indicator light-Battery power Saving Mode** section for more information.

8. Move the choke lever to the "RUN" position.



9. Allow generator to run at no load for few minutes upon each initial start-up to permit engine and generator to stabilize.

### Starting the Generator (Electric Start-LPG)

1. Before starting the generator, check for loose or missing parts and for any damage which may have occurred during shipment.
2. Check oil level.

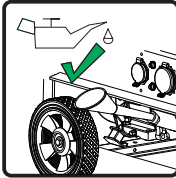

3. Connect the regulator to both LPG cylinder and generator.

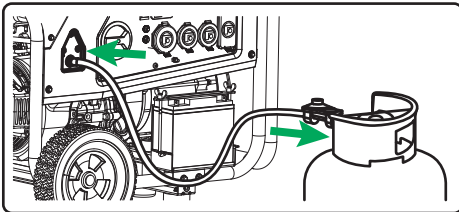

**NOTE:** Do not place LPG cylinder in the path of muffler outlet.

4. Fully open the LPG cylinder knob.

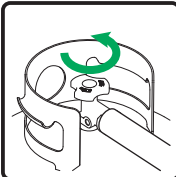

5. Turn the fuel selector switch to "LPG" position.

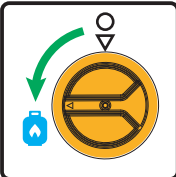

**NOTE:** When the fuel selector switch is turned to the "LPG" position, the indicator light will become **RED** up to **4 minutes**(before goes off). Starting the engine successfully during these **4 minutes** will turn the indicator light **GREEN**.

6. Disconnect all electrical loads from the generator. Never start or stop the generator with electrical devices plugged in or turned on.

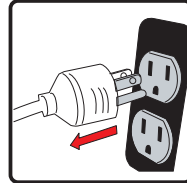

7. Move choke lever located on engine to "START" position.



8. Flip the engine switch to the "START"(II) position for few seconds and then release.



**REMINDER:** MUST HAVE **SOLID RED INDICATOR LIGHT** TO BE ABLE TO START THE GENERATOR. THE GENERATOR CANNOT BE STARTED DURING **BATTERY POWER SAVING MODE** UNLESS THE FUEL SELECTOR SWITCH IS TURNED TO THE "OFF" POSITION AND THEN TURNED BACK TO THE "LPG" POSITION.

See **Indicator light-Battery power Saving Mode** section for more information.

9. Move the choke lever to the "RUN" position.



10. Allow generator to run at no load for few minutes upon each initial start-up to permit engine and generator to stabilize.

## Connecting Electrical Loads

This unit has been pretested and adjusted to handle its full capacity. Before starting the generator, disconnect all load. Apply load only after generator is running. Voltage is regulated via the engine speed adjusted at the factory for correct output. Readjusting will void warranty.

### **⚠ CAUTION**

When applying a load, do not exceed the maximum wattage rating of the generator when using one or more receptacles. Also, do not exceed the amperage rating of any one receptacle.

Do not apply heavy electrical load during break-in period (the first five hours of operations).

1. Let engine stabilize and warm up for a few minutes after starting.
2. Ensure circuit breaker on control panel is in on position.
3. Plug in and turn on the desired 120 Volt AC, single phase, 60Hz electrical loads. It is better to attach the item with largest load first.

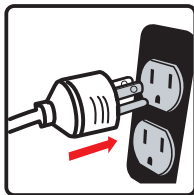

### **NOTE:**

Connecting a generator to your electric utility company's power lines or to another power source may be against the law. In addition this action, if done incorrectly, could damage your generator and appliances and could cause serious injury or even death to you or a utility worker who may be

working on nearby power lines. If you plan to run a portable electric generator during an outage, please notify your electric utility company immediately and remember to plug your appliances directly into the generator. Do not plug the generator into any electric outlet in your home. Doing so could create a connection to the utility company power lines. You are responsible for ensuring that your generator's electricity does not feed back into the electric utility power lines. If the generator will be connected to a building electrical system, consult your local utility company or a qualified electrician. Connections must isolate generator power from utility power and must comply with all applicable laws and codes.

## Stopping the Engine

1. Turn off and remove entire electrical loads. Never start or stop the generator with electrical devices plugged in or turned on.

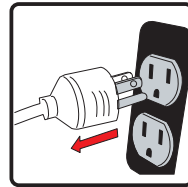

Let the generator run at no-load for two minutes to stabilize internal temperatures of the engine and generator.

2. Turn the fuel selector switch to **OFF (O)** position.

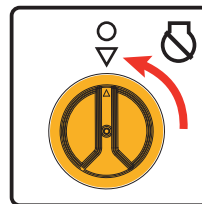

**GAS**

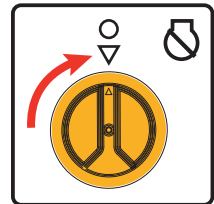

**LPG**

3. Fully close the LPG cylinder knob.



If a cover is used, do not install until unit has cooled.

**NOTE:** Disconnect the LPG cylinder from the generator during transportation.



Fuel and its vapors are extremely flammable and explosive which could cause burns, fire or explosion resulting in death, serious injury and/or property damage.

DO NOT stop engine by moving choke control to **"START"** position.

**Important:** Always ensure that the fuel selector switch is in the **"OFF"** position when the engine is not in use.

### **NOTE:**

If the engine will not be used for a period of two weeks or longer, please see the Storage section for proper engine and fuel storage.

## **Indicator light - Battery Power Saving Mode**

This generator is equipped with an electronic module which consumes battery power. When the fuel selector switch is turned to the **"GAS"** or **"LPG"** position, the indicator light will become **RED** up to **4 minutes**(before goes off).

Starting the engine successfully during these **4 minutes** will turn the indicator light **GREEN**.

Starting the engine unsuccessfully or not attempting to start the engine at all during these **4 minutes** will switch generator to **Battery Power Saving Mode** in order to conserve and increase the life of battery. **MUST HAVE SOLID RED INDICATOR LIGHT TO BE ABLE TO START THE GENERATOR. THE GENERATOR CANNOT BE STARTED DURING BATTERY POWER SAVING MODE UNLESS THE FUEL SELECTOR SWITCH IS TURNED TO THE "OFF" POSITION AND THEN TURNED BACK TO THE "GAS" OR "LPG" POSITION.**

Unwanted Shutdown:

The indicator light will start **FLASHING** for **4 minutes** in the event of any unwanted shutdown such as low oil, running out of fuel(gasoline or LPG), or any other unwanted shutdown. This is a reminder that the generator is switching to **Battery Power Saving Mode**. The generator should be checked

for any unwanted shutdown.

The generator cannot be started during or after the **4 minutes** of **FLASHING** mode unless the fuel selector switch is turned to the **"OFF"** position and then turned back to the **"GAS"** or **"LPG"** position.

### **NOTE:**

This generator is equipped with an automatic battery charging circuit and the battery will receive a proper charge when the engine is running to keep the battery charged.

## **Low Oil Shutdown**

If the engine oil drops below a preset level, an oil switch will stop the engine. Check oil level with dipstick.

If oil level is between LOW and HIGH mark on dipstick:

1. DO NOT try to restart the engine.
2. Contact an Authorized FIRMAN Service Dealer.
3. DO NOT operate engine until oil level is corrected.

If oil level is below LOW mark on dipstick:

1. Add oil to bring level to HIGH mark.
2. Restart engine and if the engine stops again a low oil condition may still exist. DO NOT try to restart the engine.
3. Contact an Authorized FIRMAN Service Dealer.
4. DO NOT operate engine until oil level is corrected.

## **Do Not Overload Generator**

Overloading a generator in excess of its rated wattage capacity can result in damage to the generator and to connected electrical devices.

To prolong the life of your generator and attached devices, follow these steps to add electrical load:

1. Start the generator with no electrical load attached.
2. Allow the engine to run for several minutes to stabilize.
3. Plug in and turn on the first item. It is best to attach the item with the largest load first.
4. Allow the engine to stabilize.
5. Plug in and turn on the next item.
6. Allow the engine to stabilize.
7. Repeat steps 5-6 for each additional item.

## NOTE:

Observing frost on LPG cylinders and regulators is common during operation and normally is not an indication of a problem. As LPG vaporizes and travels from the tank to the generator engine it expands. The amount of frost that forms can be affected by the size of the cylinder, the amount of fuel being used, the humidity of the air and other operating conditions. In unusual situations this frost may eventually restrict the flow of LPG gas to the generator resulting in deteriorating performance. For example, if the tank temperature is reduced to a very low level then the rate at which the LPG vaporizes is also reduced and may not provide sufficient fuel flow to the engine. This is not an indication of a problem with the generator but only a problem with the flow of gas from the LPG cylinder. If generator performance seems to be deteriorating at the same time that ice formation is observed on tank valve, hose or regulator then some actions may be taken to eliminate this symptom. In these rare situations it can be helpful to reduce or eliminate the cold fuel system effects by doing one of the following:

- Exchanging fuel tanks to allow the first tank to warm up, repeating as necessary
- Placing the LPG cylinder at the end of the generator near the handle, where engine fan air flows out from the generator. This air is slightly heated by flowing over the engine.

## DANGER

DO NOT PLACE THE LPG CYLINDER IN THE PATH OF MUFFLER OUTLET.

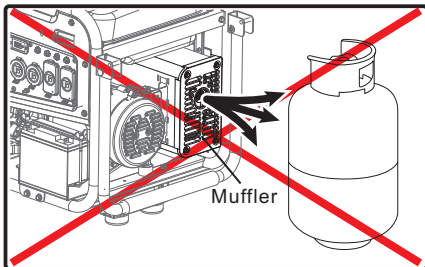

- The LPG cylinder can be temporarily warmed by pouring warm water over the top of the cylinder.

# MAINTENANCE AND STORAGE

## MAINTENANCE SCHEDULE

ITEM	NOTES	Daily(Before operation)	Initial 25 hours	Every 50 hours	Every 100 hours (or annual)
Spark Plug	Check condition. Adjust gap and clean. Replace if necessary.				✓
Engine Oil	Check oil level.	✓			
	Replace.		✓		✓
Air Filter	Clean, replace if necessary.			✓	
Fuel Filter	Clean fuel filter and fuel tank strainer. Replace if necessary.				✓
Fuel Line	Check fuel hose for cracks or other damage. Replace if necessary.	✓			
LPG Regulator /Hose Assy.	Check for damage and leaks. Replace if necessary.	✓			
Exhaust System	Check for leakage. Retighten or replace gasket if necessary.	✓			
	Check spark arrester screen. Clean/Replace if necessary.				✓
Carburetor	Check choke operation.	✓			
Starting System	Check recoil starter operation.	✓			
Fittings/ Fasteners	Check. Replace if necessary.				✓

### General Recommendations

Regular maintenance will improve the performance and extend the life of the generator. See any authorized dealer for service.

The generator's warranty does not cover items that have been subjected to operator abuse or negligence. To receive full value from the warranty, the operator must maintain the generator as instructed in this manual.

Some adjustments will need to be made periodically to properly maintain your generator. All service and adjustments should be made at least once each season. Follow the requirements in the Maintenance Schedule chart above.

**Notice** Once a year you should clean or replace the spark plug and replace the air filter. New spark plugs and clean air filter assure proper fuel-air mixture and help your engine run better and last longer.

## ENGINE MAINTENANCE

To prevent accidental starting, remove and ground spark plug wire before performing any service.

### Change Engine Oil

Change engine oil every 100 hours.  
(for a new engine, change oil after 25 hours.)

If you are using your generator under extremely dirty or dusty conditions, or in extremely hot weather, change the oil more often.

#### CAUTION

Avoid prolonged or repeated skin contact with used motor oil.

- Used motor oil has been shown to cause skin cancer in certain laboratory animals.
  - Thoroughly wash exposed areas with soap and water.
- (a) Drain oil by removing the drain plug and the oil filler cap while the engine is warm.

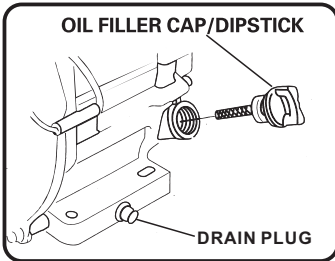

#### NOTE:

Please use a container to dump the used oil for protecting the environment.

(b) Reinstall the drain plug and fill the engine with oil until it reaches the HIGH(H) level on the oil filler cap.

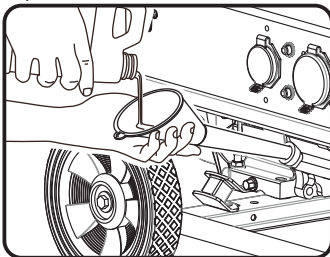

- Use fresh and high quality lubricating oil to the specified quantity.  
If contaminated or deteriorated oil is used or the quantity of the engine oil is not sufficient, the engine damage will result and its life will be greatly shortened.

### Air Filter Maintenance

Maintaining an air filter in proper condition is very important. Dirt induced through improperly installed, improperly serviced, or inadequate elements damages and wears out engines. Always keep the element clean.

(a) Take out the air cleaner, clean it well in kerosene and dry it.

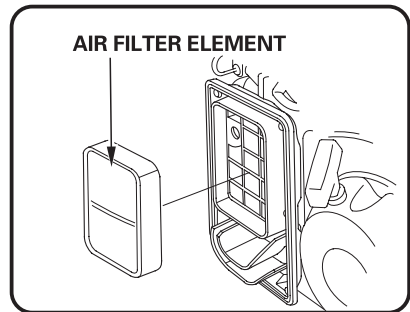
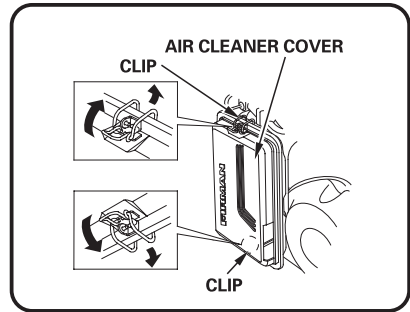

(b) After wetting the element by clean engine oil squeeze it tight by hand.

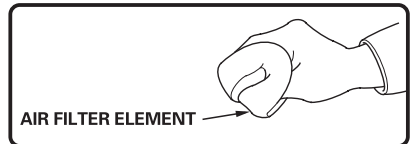

(c) Lastly, put the element in the case and install it securely.

## Spark Plug Maintenance

Changing the spark plug will help your engine to start easier and run better.

- Remove the spark plug cap.
- Remove spark plug using provided wrench.

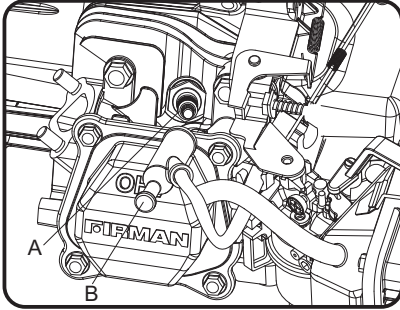

- A- Spark plug  
B- Spark plug cap

- Inspect spark plug for damage and clean with a wire brush before reinstalling
- Adjust the electrode gap to 0.7 to 0.8 mm (0.028" to 0.031").
- Seat spark plug in position and thread by hand to prevent cross threading.
- Tighten plug with provided wrench and put the cap back on spark plug.

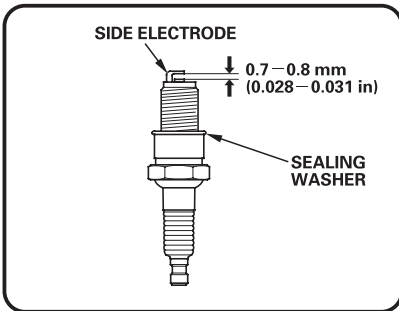

SPARK PLUG: TORCH F6RTC  
NGK BPR6ES  
CHAMPION RN9YC equivalent.

## Inspect Muffler and Spark Arrester

Inspect the muffler for cracks, corrosion, or other damage. Remove the spark arrester, if equipped, and inspect for damage or carbon blockage. If replacement parts are required, make sure to use only original equipment replacement parts.

### ⚠ WARNING



Exhaust heat/gases could ignite combustibles, structures or damage fuel tank causing a fire, resulting in death or serious injury and/or property. Contact with muffler area could cause burns resulting in serious injury.

- **DO NOT** touch hot parts and **AVOID** hot exhaust gases.
- Allow equipment to cool before touching.
- Keep at least 5 feet (1.5 m) of clearance on all sides of generator including overhead.
- Replacement parts must be the same and installed in the same position as the original parts.

## Clean or replace spark arrester as follows:

Depending on the type fuel used, the type and amount of lubricant used, and/or your operating conditions, the exhaust part and muffler may become blocked with carbon deposits. If you notice power loss, you may need to remove these deposits to restore performance.

- Allow the engine to cool completely before servicing the spark arrester.
- Remove the screws securing the spark arrester in place and the remove it from muffler.



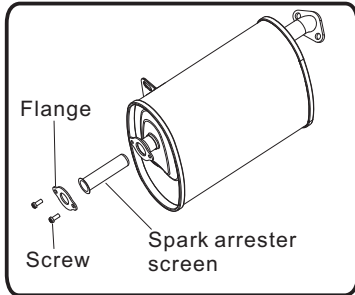

3. Carefully remove the carbon deposits from the spark arrester screen with a wire brush.

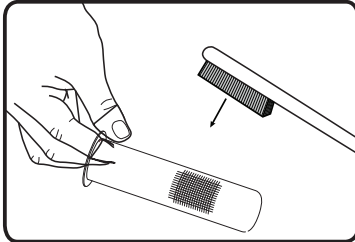

4. Replace the spark arrester if it is damaged.
5. Position the spark arrester in the muffler and attach with the screws.

### ⚠ CAUTION

Failure to clean the spark arrester will result in degraded engine performance.

## GENERATOR MAINTENANCE

Make certain that the generator is kept clean and stored properly. Only operate the unit on a flat, level surface in a clean, dry operating environment. **DO NOT** expose the unit to extreme conditions, excessive dust, dirt, moisture or corrosive vapours.

### ⚠ CAUTION

**DO NOT** use a garden hose to clean the generator. Water can enter the generator through the cooling slots and damage the generator windings.

Use a damp cloth to clean exterior surfaces of the generator.

Use a soft bristle brush to remove dirt and oil.

Use an air compressor (25 PSI) to clear dirt and debris from the generator.

Inspect all air vents and cooling slots to ensure that they are clean and unobstructed.

## Battery Replacement

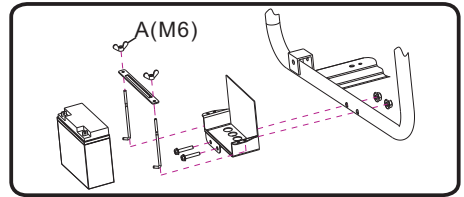

1. Remove the spark plug wire from spark plug.
2. Remove the nut and bolt from the negative(-) and positive(+) posts.
3. Loosen and remove the screw A on the battery holding bracket.
4. Remove the battery and recycle and dispose of properly.
5. Install the new battery with following specification:  
12V sealed lead acid 15AH  
LXWXH:180X75X165mm(7.09X2.95X6.5inch)
6. Connect the red positive(+) battery cable to the battery first.
7. Connect the black positive(-) battery cable to the battery second.
8. Cover the post with boots.
9. Install the spark plug wire onto spark plug.

### ⚠ WARNING



#### To avoid electric shock:

**ALWAYS** connect the positive (+) battery cable (red boot) first when connecting battery cables.

**ALWAYS** disconnect the negative (-) battery cable (black boot) first when disconnecting battery cables.

**NEVER** connect the negative (-) battery cable (black boot) to the positive (+) post on the battery.

**NEVER** connect the positive (+) battery cable (red boot) to the negative (-) post on the battery.

**NEVER** touch both battery posts simultaneously. **NEVER** place a metal tool across both battery posts.

**ALWAYS** use insulated or nonconducting tools when installing the battery.

---

## SERVICE AND STORAGE

### Infrequent Service

If the unit is used infrequently, difficult starting may result. To eliminate hard starting, follow these instructions:

1. Run the generator at least 30 minutes every month.
2. Run the generator, then close the fuel shut-off valve and allow the unit to run until the engine stops.
3. Move the fuel selector to the "OFF" position.

### Long Term Storage

When the generator set is not being operated or is being stored more than one month, follow these instructions:

- 1. ADD A PROPERLY FORMULATED FUEL STABILIZER TO THE TANK.**
- 2. OPERATE THE ENGINE FOR 5-10MINUTES TO CIRCULATE TREATED FUEL INTO THE FUEL LINES AND CARBURETOR BEFORE SHUTDOWN.**
- 3. ALLOW UNIT TO COOL ENTIRELY BEFORE CLEANING AND STORAGE.**
- 4. CHANGE OIL WITH RECOMMENDED GRADE OIL.**
- 5. REMOVE SPARK PLUG AND POUR ABOUT ONE TEASPOON OF ENGINE OIL THROUGH THE SPARK PLUG HOLE, PULL THE RECOIL STARTER SEVERAL TIMES AND REPLACE THE PLUG. THEN PULL THE STARTER UNTIL YOU FEEL THE PISTON IS ON ITS COMPRESSION STROKE AND LEAVE IT IN THAT POSITION. THIS CLOSSES BOTH THE INTAKE AND EXHAUST VALVES TO PREVENT THE INSIDE OF THE CYLINDER FROM RUSTING. REATTACH THE SPARK PLUG.**
- 6. MAKE SURE THE FUEL SELECTOR SWITCH IS ON "OFF" POSITION.**
- 7. COVER THE UNIT AND STORE IN A CLEAN, DRY PLACE THAT IS WELL VENTILATED AWAY FROM OPEN FLAME OR SPARKS.**

**NOTE:** We recommend always using a fuel stabilizer. A fuel stabilizer will minimize the formulation of fuel gum deposits during storage. The fuel stabilizer can be added to the gasoline in the fuel tank, or into the gasoline in a storage container.

### NEVER USE WATER TO CLEAN GENERATOR.

Pull starter handle until resistance is felt, leaving handle in that position.

Store generator in a well ventilated, low humidity area.

### Battery Charging & Maintenance

**The battery powers up the starter motor and the control module in this generator.** This product is equipped with an automatic battery charging circuit. The battery will receive charging voltage when the engine is running. The battery will maintain a proper charge if the unit is used on a regular basis (about once every two weeks). If it is used less frequently, the battery should be connected to a trickle charger (not included) or battery maintainer (not included) to keep the battery properly charged. If the battery is not able to start the engine, it can be started manually only on "GAS" position by pulling the engine recoil cord. If the battery voltage is extremely low, the charging circuit may not be able to re-charge the battery. In this case, the battery must be connected to a standard automotive style battery charger for re-charging before it can be used.

### WARNING

Generator exhaust contains odorless and colorless carbon monoxide gas.

To avoid accidental or unintended ignition of your generator during periods of storage, the following precautions should be followed: When storing the generator for short or extended periods of time make sure that the fuel selector switch is in the "OFF" position and the battery leads have been disconnected from the battery.

## TROUBLE SHOOTING

Problem	Cause	Correction
<b>Engine is running, but no AC output is available.</b>	<ol style="list-style-type: none"> <li>1. Circuit breaker is open.</li> <li>2. Fault in generator.</li> <li>3. Poor connection or defective cord set.</li> <li>4. Connected device is bad.</li> </ol>	<ol style="list-style-type: none"> <li>1. Reset circuit breaker.</li> <li>2. Contact authorized service facility.</li> <li>3. Check and repair.</li> <li>4. Connect another device that is in good condition.</li> </ol>
<b>Engine runs good at no-load but "bogs down" when loads are connected.</b>	<ol style="list-style-type: none"> <li>1. Short circuit in a connected load.</li> <li>2. Engine speed is too slow.</li> <li>3. Generator is overloaded.</li> <li>4. Shorted generator circuit.</li> <li>5. Clogged or dirty fuel filter.</li> </ol>	<ol style="list-style-type: none"> <li>1. Disconnect shorted electrical load.</li> <li>2. Contact authorized service facility.</li> <li>3. See Don't Overload Generator</li> <li>4. Contact authorized service facility.</li> <li>5. Clean or replace fuel filter.</li> </ol>
<b>Engine will not start; starts and runs rough or shuts down when running.</b>	<ol style="list-style-type: none"> <li>1. Fuel selector switch set to OFF (O) position.</li> <li>2. The indicator light is OFF or flashing red.</li> <li>3. Low oil level.</li> <li>4. Dirty air cleaner.</li> <li>5. Out of gasoline.</li> <li>6. Stale gasoline.</li> <li>7. Spark plug wire not connected to spark plug.</li> <li>8. Bad spark plug.</li> <li>9. Water in gasoline.</li> <li>10. Flooded.</li> <li>11. Excessively rich fuel mixture.</li> <li>12. Intake valve stuck open or closed.</li> <li>13. Engine has lost compression.</li> <li>14. Clogged or dirty fuel filter.</li> <li>15. Starting battery may have in sufficient charge.</li> <li>16. Out of LPG.</li> <li>17. LPG cylinder knob is not open.</li> <li>18. Out of battery Power.</li> </ol>	<ol style="list-style-type: none"> <li>1. Set fuel selector switch to "GAS" or "LPG" position.</li> <li>2. Must have solid red indicator light to be able to start the engine.</li> <li>3. Fill crankcase to proper level or place generator on level surface.</li> <li>4. Clean or replace air cleaner.</li> <li>5. Fill fuel tank with gasoline.</li> <li>6. Drain fuel tank and carburetor; fill with fresh gasoline.</li> <li>7. Connect wire to spark plug.</li> <li>8. Replace spark plug.</li> <li>9. Drain gas tank and carburetor; fill with fresh gasoline.</li> <li>10. Wait 5 minutes and re-crank engine.</li> <li>11. Contact authorized service facility.</li> <li>12. Contact authorized service facility.</li> <li>13. Contact authorized service facility.</li> <li>14. Clean or replace fuel filter.</li> <li>15. Check battery output and charge battery as necessary.</li> <li>16. Replace LPG tank.</li> <li>17. Fully open LPG cylinder knob.</li> <li>18. Start Engine in "GAS" position. Charge or replace battery.</li> </ol>
<b>Engine lacks power.</b>	<ol style="list-style-type: none"> <li>1. Load is too high.</li> <li>2. Dirty air filter.</li> <li>3. Clogged or dirty fuel filter.</li> <li>4. Clogged spark arrester.</li> </ol>	<ol style="list-style-type: none"> <li>1. Don't Overload Generator</li> <li>2. Replace air filter.</li> <li>3. Clean or replace fuel filter.</li> <li>4. Clean or replace spark arrester.</li> </ol>
<b>Engine "hunts" or falters.</b>	<ol style="list-style-type: none"> <li>1. Carburetor is running too rich or too lean.</li> <li>2. Clogged or dirty fuel filter.</li> </ol>	<ol style="list-style-type: none"> <li>1. Contact authorized service facility.</li> <li>2. Clean or replace fuel filter.</li> </ol>
<b>Engine shuts down when running.</b>	<ol style="list-style-type: none"> <li>1. Out of gasoline or LPG.</li> <li>2. Dirty air cleaner.</li> <li>3. Low oil level.</li> </ol>	<ol style="list-style-type: none"> <li>1. Fill fuel tank with gasoline or replace LPG tank.</li> <li>2. Clean or replace air cleaner.</li> <li>3. Fill crankcase to proper level or place generator on level surface.</li> </ol>

**PARTS DIAGRAM AND PART LIST**

**H08051 PARTS DIAGRAM**

# 439cc DUAL FUEL ENGINE PARTS DIAGRAM

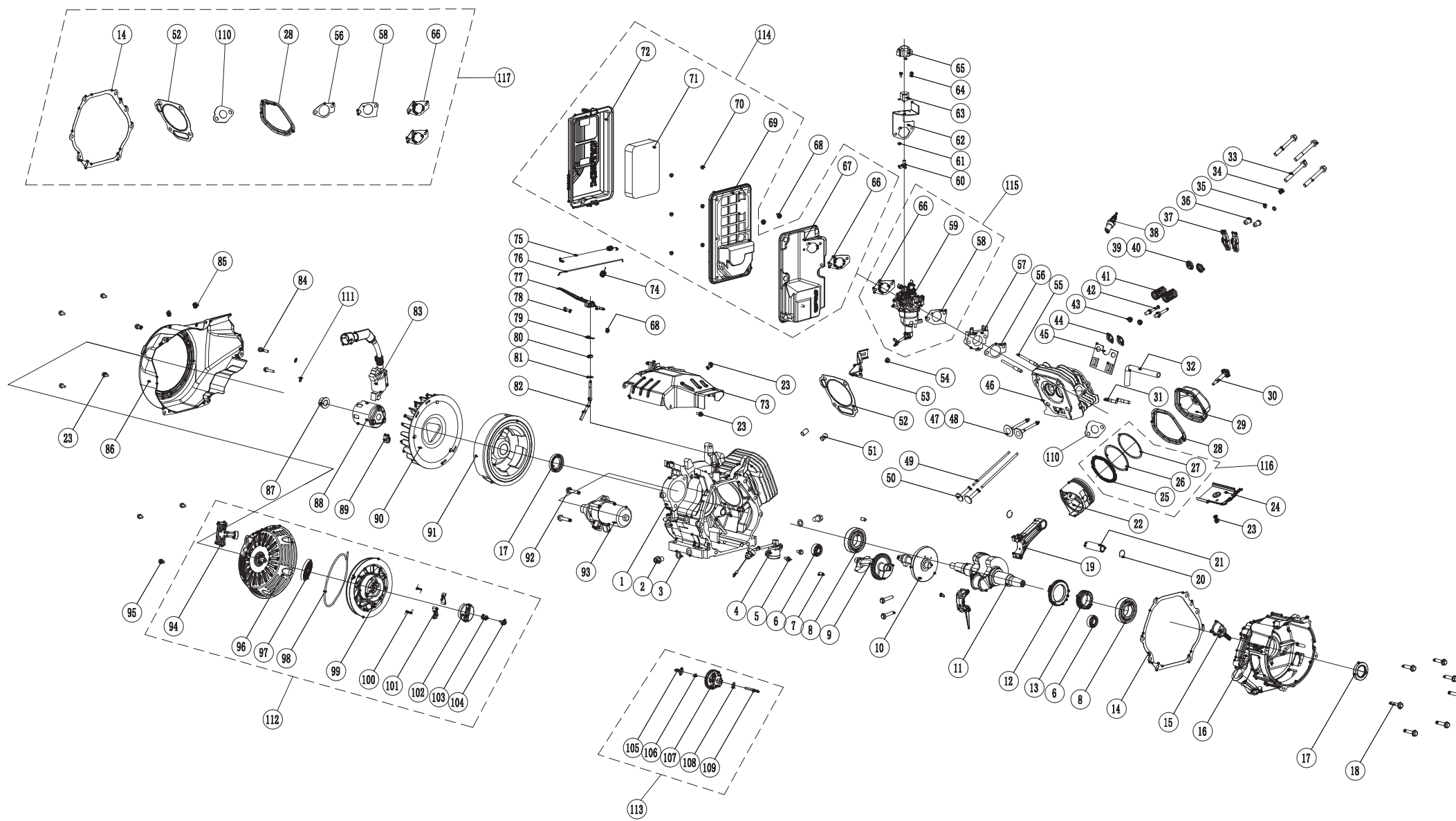

## H08051 PARTS LIST

NO.	Part Number	Description	Qty.
1	336713800	FIRMAN 208cc Dual Fuel Engine	1
2	336713501	Rubber Cap 2	1
3	336713502	Rubber Cap1	1
4	336713604	Rotor Assy	1
5	336713605	Stator Assy	1
6	336713801	Stator Cover	1
7	336713506	Generator End Cover	1
8	336713507	Flange Bolt M5×12	3
9	336713508	Flange Bolt M8×252	1
10	336713509	Lock Washer Ø8	3
11	336713510	Flat Washer Ø8	3
12	336713511	Flange Bolt M6×179	4
13	336713512	Lock Washer Ø6	10
14	336713513	Flat Washer Ø6	6
15	336713514	Ground Wire	1
16	336713515	Flange Bolt M6×12	19
17	336713516	External Star Washer ø6	2
18	336713517	Nut M6	6
19	336713518	AVR	1
20	336713519	Flange Bolt M5×16	2
21	336713520	Bolt &washer Assemblies	2
22	336713521	Generator End Cover Cap	1
23	336713522	Ground Wire	1
24	336713523	Terminal Block	1
25	336713524	Bolt &washer Assemblies	2
26	336713525	Carbon Brush Holder	1
27	336713526	Carbon Brush Assembly	1
28	336713527	Air Filter Bracket	1
29	336713528	Flange Bolt M6×8	4
30	336713529	Muffler Fixed Plate A(Small)	1
31	336713530	Muffler Fixed Plate B(Big)	1
32	336713531	Flange Bolt M8×20	3
33	336713532	Muffler Gasket	1
34	336713533	Flat Washer Ø8	2
35	336713534	Nut M8	2
36	336713535	Muffler Assembly	1
37	336713536	Arrester,Spark	1
38	336713537	Holder,Spark Arrester	1
39	336713538	Screw&washer Assy M5×14	2
40	336713540	Clamp Ø8×6	7
41	336713802	Hose, Fuel 1	1
42	336713803	Hose, Fuel 2	1
43	336713804	Fuel Tank Assy.	1
44	336713542	Grommet, Fuel Tank	4
45	336713543	Washer Tank Buffer	4
46	336713544	Flange Bolt M6×20	4
47	336713805	Fuel Gauge Assy.	1
48	336713546	Screw M5×10	2
49	336713547	Fuel Gauge Display	1
50	336713806	Fuel Filter, Wire Mesh	1
51	336713549	Fuel Cap	1
52	336713807	Tank Fitting with Filter	1
53	336713808	Guard,Muff.	1
60	336713554	Axle Pin	2
61	336713836	Wheel	2
62	336713590	Cotter Pin	2
63	336713810	Plastic Front Cover	1
64	336713811	Frame	1
65	336713558	Nut M8	12
66	336713841	Red Boot	1
67	336713842	Black Boot	1
68	336713562	Isolator 1	2

NO.	Part Number	Description	Qty.
69	336713563	Isolator 2	2
70	336713608	Battery Holder	1
71	336713578	Nut M5	2
72	357713569	Screw&washer Assy M5×10	2
73	336713814	Battery	1
74	336713609	Battery Pressing Plate	1
75	336713621	Flange Bolt M8×40	2
76	336713610	Red Cable	1
77	336713611	Boot, Starter	1
78	336713612	Black Cable	1
79	336713559	Flange Bolt M8×16	2
80	336713560	Support Leg	1
81	336713561	Flange Bolt M6×25	2
82	336713557	Rubber, Support	2
83	336713815	Twist Switch	1
84	336713816	Screw M4×12	1
85	336713565	Screw M5×14	4
86	336713817	Control Module	1
87	336713818	Charger	1
88	336713819	Tapping Screw ST2.9X19	2
89	336713820	Tapping Screw ST2.9X25	1
90	336713821	Micro Switch 1	1
91	336713822	Micro Switch 2	2
92	336713823	Main Regulator Assy.	1
93	336713824	Fuel Valve	1
94	336713825	Screw M6×12	3
95	336713826	LPG Inlet Cover	1
96	336713827	Electric Start Switch	1
97	336713828	Indicator Light	1
98	336713829	Multi Meter	1
99	336713573	Outlet Cover L5-30R	1
100	336713574	Outlet Cover TT-30R	1
101	357713542	Flange Bolt M6×22	1
102	357713543	Nut M6	2
103	336713830	Tapping Screw	2
104	336713575	Outlet Cover 5-20R	1
105	330713582	Screw&washer Assy M4×14	6
106	336713831	Control Panel	1
107	336713832	Receptacle L5-30R	1
108	336713584	Receptacle TT-30R	1
109	336713588	Receptacle 5-20R	1
110	336713568	Nut M4	8
111	336713585	Circuit Breaker 30A	1
112	336713586	Circuit Breaker 20A	1
113	336713569	Screw&washer Assy M4×8	4
114	336713833	Control Box	1
115	336713581	Grommet	1
116	336713582	Sleeve	1
117	336713587	Grommet	1
118	336413513	Control Panel Assy.	1
119	336413514	Portability Kit	1
120	336413507	Rotor And Stator Set	1
121	336413503	Spark Arrester Kit	1
122	336413509	Support Leg Assembly	1
123	336713834	LPG Hose	1
124	336713835	Clamp (Ø8-Ø14)Xb8	1
125	336713836	Regulator / Hose Assy.	1



---

---

## SERVICE INFORMATION

### CONTACT THE FIRMAN PRODUCT SERVICE DEPARTMENT AT 1-844-347-6261

or at [www.firmangenerators.com](http://www.firmangenerators.com)  
to obtain warranty service  
information or to order  
replacement parts or  
accessories.

## HOW TO ORDER REPLACEMENT PARTS

Even quality built equipment such as the electric generator you have purchased might need occasional replacement parts to maintain it in good condition over the years. To order replacement parts, please give the following information:

1. Model No. ,Rev. Level and Serial No. and all specifications shown on the Model No./Serial No. plate.
2. Parts number or numbers as shown in the Parts List section.
3. A brief description of the trouble with the generator.

## REGISTER YOUR PRODUCT

Register your Firman generator online at [www.firmangenerators.com](http://www.firmangenerators.com)

## WARRANTY

### FIRMAN Three (3) Year Limited Warranty

#### Warranty Qualifications

FIRMAN GENERATOR will register the warranty upon receipt of your Warranty Registration Card and a copy of your sales receipt from one of FIRMAN's retail locations as proof of purchase. Please submit your warranty registration and your proof of purchase within ten (10) days of the date of purchase.

#### Repair/Replacement Warranty

FIRMAN warrants to the original purchaser that the mechanical and electrical components will be free of defects in material and workmanship for a period of one (1) year (parts and labor) and three (3) years (parts) from the original date of purchase 90 days [parts and labor] and 180 days [parts] for commercial & industrial use. Transportation charges on product submitted for repair or replacement under this warranty are the sole responsibility of the purchaser. This warranty only applies to the original purchaser and is not transferable.

#### Do Not Return the Unit to the Place of Purchase

Contact the FIRMAN Service Center and FIRMAN will troubleshoot any issue via phone or e-mail. If the problem is not corrected by this method, FIRMAN will, at its option, authorize evaluation, repair or replacement of the defective part or component at a FIRMAN Service Center. FIRMAN will provide you with a case number for warranty service. Please keep it for future reference. Repairs or replacements without prior authorization, or at an unauthorized repair facility, will not be covered by this warranty.

#### Warranty Exclusions

This warranty does not cover the following repairs and equipment:

##### Normal Wear

Your product needs periodic parts and service to perform well. This warranty does not cover repair when normal use has exhausted the life of a part or the equipment as a whole.



---

---

## Installation, Use and Maintenance

This warranty will not apply to parts and/or labor if your product is deemed to have been misused, neglected, involved in an accident, abused, loaded beyond the generator's limits, modified, installed improperly or connected incorrectly to any electrical component.

Normal maintenance is not covered by this warranty.

## Other Exclusions

This warranty excludes:

- cosmetic defects such as paint, decals, etc.
- wear items
- accessory parts
- failures due to acts of God and other force majeure events beyond the manufacturer's control
- problems caused by parts that are not original FIRMAN parts

## Limits of Implied Warranty and Consequential Damage

FIRMAN disclaims any obligation to cover any loss of time, use of this product, freight, or any incidental or consequential claim by anyone from using this product. THIS WARRANTY IS IN LIEU OF ALL OTHER WARRANTIES, EXPRESS OR IMPLIED, INCLUDING WARRANTIES OF MERCHANTABILITY OR FITNESS FOR A PARTICULAR PURPOSE.

A unit provided as an exchange will be subject to the warranty of the original unit. The length of the warranty governing the exchanged unit will remain calculated by reference to the purchase date of the original unit.

This warranty gives you certain legal rights which may change from state to state. Your state may also have other rights you may be entitled to that are not listed within this warranty.

## Contact Information

You may contact FIRMAN at:

### Address

Firman Power Equipment Inc.  
Attn: Customer Service  
14131 N Rio Vista Blvd Suite 9  
Peoria, AZ 85381  
www.firmangenerators.com

*We are FIRMAN POWER - And we are here for you.  
Customer Service Desk - 1-844-347-6261(844-FIRMAN1)  
6am PST(9am EST) until 8pm EST(5pm PST)  
Technical Service Desk - 1-844-347-6261(844-FIRMAN1)  
6am PST(9am EST) until 8pm EST(5pm PST)  
24/7 Tech Support - 1-844-347-6261(844-FIRMAN1)*

---

---

# FIRMAN POWER EQUIPMENT INC.

## Emission Control System Warranty

### CALIFORNIA AND FEDERAL EXHAUST AND EVAPORATIVE EMISSIONS CONTROL WARRANTY STATEMENT GASOLINE ENGINES

#### YOUR WARRANTY RIGHTS AND OBLIGATIONS

The California Air Resources Board, US Environmental Protection Agency ("US EPA") and FIRMAN POWER EQUIPMENT INC. (FIRMAN) are pleased to explain the exhaust and evaporative emissions control systems warranty on your 2016-2017 or later Small Off-Road Engine ("SORE") and engine powered equipment as applicable. In California and the USA, SORE and engine powered equipment must be designed, built and equipped to meet California as applicable. In California and the USA, SORE and engine powered equipment must be designed, built and equipped to meet California and US EPA stringent anti-smog standards. FIRMAN must warrant the emissions control systems on your SORE and engine powered equipment for the period listed below provided there has been no abuse, neglect or improper maintenance of your SORE or engine powered equipment. Your exhaust emission control systems may include parts such as carburetors, fuel-injection systems, the ignition system, and catalytic converters. Also included may be an evaporative emission control system which may include fuel tanks, fuel lines, fuel caps, valves, canisters, filters, vapor hoses, clamps, connectors, belts and other associated components. For engines less than or equal to 80 cc, only the fuel tank is subject to the evaporative emission control warranty requirements of this section (California only).

#### OWNER'S WARRANTY RESPONSIBILITIES:

As the SORE or engine powered equipment owner, you are responsible for the performance of the required maintenance listed in your owner's manual. FIRMAN recommends that you retain all receipts covering maintenance on your SORE or engine powered equipment, but FIRMAN cannot deny warranty solely for the lack of receipts.

As the SORE or engine powered equipment owner, you should however be aware that FIRMAN may deny you warranty coverage if your SORE or engine powered equipment or a part has failed due to abuse, neglect, improper maintenance or unapproved modifications.

You are responsible for presenting your SORE or engine powered equipment to a FIRMAN distribution or service center as soon as a problem exists. The warranty repairs should be completed in a reasonable amount of time, not to exceed 30 days. If you have a question regarding your warranty coverage, you should contact FIRMAN at 1-844-347-6261 or firmangenerators@sumec-na.com.

#### GENERAL EMISSIONS WARRANTY COVERAGE

This emission control system is warranted for three years. The warranty period begins on the date the engine or equipment is delivered to an ultimate purchaser. FIRMAN warrants to the ultimate purchaser and each subsequent purchaser that the engine is:

Designed, built, and equipped so as to conform with all applicable regulations adopted by the Air Resources Board and US EPA; and Free from defects in materials and workmanship that cause the failure of a warranted part to be identical in all material respects to the part as described in the engine manufacturers application for certification.

The warranty on emissions-related parts is as follows:

- (1) Any warranted part that is not scheduled for replacement as required maintenance in the owner's manual supplied, is warranted for the warranty period stated above. If any such part fails during the period of warranty coverage, the part will be repaired or replaced by FIRMAN at no charge to the owner. Any such part repaired or replaced under the warranty will be warranted for the remaining warranty period.
- (2) Any warranted part that is scheduled only for regular inspection in the owner's manual supplied, is warranted for the warranty period stated above. Any such part repaired or replaced under warranty will be warranted for the remaining warranty period.
- (3) Any warranted part that is scheduled for replacement as required maintenance in the owner's manual supplied, is warranted for the period of time prior to the first scheduled replacement point for that part. If the part fails prior to the first scheduled replacement, the part will be repaired or replaced by FIRMAN at no charge to the owner. Any such part repaired or replaced under warranty will be warranted for the remainder of the period prior to the first scheduled replacement point for the part.
- (4) Repair or replacement of any warranted part under the warranty must be performed at no charge to the owner at a warranty station.
- (5) Notwithstanding the provisions of Subsection (4) above, warranty services or repairs must be provided by FIRMAN that are franchised to service the subject engines.
- (6) The owner must not be charged for diagnostic labor that leads to the determination that a warranted part is in fact defective, provided that such diagnostic work is performed at a warranty station.
- (7) FIRMAN is liable for damages to other engine components proximately caused by a failure under warranty of any warranted part.
- (8) Throughout the emissions warranty period defined in Subsection (b)(2), FIRMAN will maintain a supply of warranted parts sufficient to meet the expected demand for such parts.
- (9) Any replacement part may be used in the performance of any warranty maintenance or repairs and must be provided without charge to the owner. Such use will not reduce the warranty obligations of the manufacturer.
- (10) Add-on or modified parts that are not exempted by the Air Resources Board may not be used. The use of any non-exempted add-on or modified parts by the ultimate purchaser will be grounds for disallowing a warranty claim.

The manufacturer will not be liable to warrant failures of warranted parts caused by the use of a non-exempted add-on or modified part.

---

---

## PARTS COVERED BY WARRANTY

Listed below are the parts (if equipped) covered by the Federal and California Emission Control Systems Warranty. Some parts listed below may require scheduled maintenance and are warranted up to the first scheduled replacement point for that part.

1. Ignition system including: - Spark plug - Ignition coil	4. Air induction system including: - Intake pipe/manifold - Air cleaner
2. Fuel metering system: - Fuel tank - Fuel cap - Fuel line and related fittings/clamps - Carburetor assembly including internal parts and gaskets	5. Crankcase breather assembly including: - Breather connection tube
3. Catalytic muffler assembly including: - Exhaust manifold - Catalytic converter - Muffler gasket - pulse valve	6. Fuel tank evaporative emission control system including: - Purge valves - Carbon canister - Vapor hoses and fitting/clamps

### Limitations

This Emission Control Systems Warranty shall not cover any of the following:

- (a) Consequential damages such as loss of time, inconvenience, loss of use of the engine or equipment, etc.
- (b) Diagnosis and inspection fees that do not result in eligible warranty service being performed.

FIRMAN POWER EQUIPMENT INC.  
firmangenerators@sumec-na.com  
www.firmangenerators.com

**Firman Power Equipment Inc.**

14131 N Rio Vista Blvd Suite 9

Peoria, AZ 85381

[www.firmangenerators.com](http://www.firmangenerators.com)