



POLIRONE SHOP

Sede Legale

Via Ferri, 138/c - 46027 San Benedetto Po (MN)
P. IVA 02252900200 C.F. CSTPLA77B48E897W

Magazzino esposizione

Via dell'Alpino 7 – Fraz. San Biagio – 46031 Bagnolo San Vito (MN)
Tel. 0376-414066 393-2834704 393-5305228
www.polironeshop.it info@polironeshop.it

CATALOGO COMPLETO





MOD. LEON

Rimorchio bici + passeggino per 1 o 2 bambini
 Peso: 15 kg
 Peso trasportabile: 45 kg
 Ruota anteriore fissa e/o piroettante
 Con sospensioni e freni su ruote posteriori
 Larghezza seduta: 60 cm
 2 ruote laterali da 50 cm + 1 frontale da 30 cm



MOD. B-FOX

Rimorchio bici + passeggino per 1 o 2 bambini
 Peso: 15 kg
 Peso trasportabile: 45 kg
 Ruota anteriore piroettante
 Con freni su ruote posteriori
 Larghezza seduta: 60 cm
 2 ruote laterali da 50 cm + 1 frontale da 25 cm
 Pratico sistema di chiusura, senza smontaggio.



MOD. EAGLE

Rimorchio bici per 1 o 2 bambini
 Peso: 14 kg
 Peso trasportabile: 45 kg
 Con sospensioni
 Larghezza seduta: 60 cm
 2 ruote laterali da 50 cm



MOD. MOVER

Rimorchio bici + passeggino per 1 o 2 bambini
 Peso: 15 kg
 Peso trasportabile: 45 kg
 Ruota anteriore piroettante
 Con sospensioni e freno a cinghia su ruote posteriori
 Larghezza seduta: 55 cm
 2 ruote laterali da 50 cm + 1 frontale da 30 cm



MOD. CRONO

Rimorchio bici + passeggino per 1 o 2 bambini
 Peso: 15 kg
 Materiale: alluminio
 Peso trasportabile: 45 kg
 Ruote anteriori piroettanti*
 Con sospensioni regolabili su tre livelli
 Chiusura con chiave
 Freni su ruote posteriori
 Larghezza seduta: 55 cm
 2 ruote laterali da 50 cm + 2 frontali da 20 cm
 Sistema di chiusura rapido one-touch

** Disponibile come optional ruota anteriore
 singola per jogging*



MOD. FOX

Rimorchio bici + passeggino per 1 bambino
 Peso: 13 kg
 Peso trasportabile: 45 kg
 Ruota anteriore piroettante
 Con freni su ruote posteriori
 Larghezza seduta: 42 cm
 2 ruote laterali da 40 cm + 1 frontale da 25 cm
 Pratico sistema di chiusura, senza smontaggio.



MOD. KORE

Rimorchio bici + passeggino per 1 bimbo
 Peso: 14 kg
 Materiale: alluminio
 Peso trasportabile: 45 kg
 Ruote anteriori piroettanti*
 Larghezza seduta: 42 cm
 2 ruote laterali da 50 cm + 2 frontali da 20 cm
 Sistema di chiusura rapido one-touch

** Disponibile come optional ruota anteriore
 singola per jogging*



RUOTA ANTERIORE SINGOLA

Ruota anteriore per rimorchio CRONO e KORE
 Diametro 40 cm



MOD. ARGO

Rimorchio bici + passeggino
Disponibile in 3 misure: S, M e L



MOD. ZETA

Rimorchio bici + passeggino
Disponibile in 3 misure: S, M e L



MOD. SNOOPY

Rimorchio bici
Disponibile in 3 misure: S, M e L



MOD. KUMA

Rimorchio bici + passeggino





MOD. VECTOR

Portata massima: 45 kg
 Struttura in alluminio
 Rivestimento in Nylon 600D
 Capacità: circa 65 litri
 Peso: circa 7 kg
 Ruota: 16" (40 cm) con parafango e riflettore
 Borsa utilizzabile a tracolla e come zaino



MOD. NOTABIKE

Struttura in acciaio e alluminio
 Utilizzabile su ruote da 20" a 29"
 Dimensioni cornice: 85 x 72
 Dimensioni utili: 82 x 70,5
 Peso: circa 7 kg
 Ruota: 30 cm
 Lunghezza complessiva: 152 cm
 Altezza complessiva da terra: 99,5 cm

ATTENZIONE: nella fornitura non sono compresi poster o tasche protettive; viene fornita solo la cornice esterna



MOD. ACHILLE

Portata massima: 50 kg
 Struttura e supporti base in acciaio, base in plastica
 Dimensioni base: 57 cm x 68 cm
 Ruote laterali da 16" (diametro 40 cm)
 Barriere di protezione per le ruote
 Barriera posteriore apribile per carichi sporgenti



MOD. GEKO

Rapida conversione da rimorchio a trolley, e viceversa
 Aggancio al reggisella rapido e senza attrezzi
 Piegato occupa pochissimo spazio
 Ruote da 12" con camera d'aria e sgancio rapido
 Borsa, cinghie e 1 aggancio al reggisella inclusi
 Peso massimo supportato: 25 kg
 Peso del rimorchio: 6 kg



MOD. ITER

Portata massima: 45 kg
 Dimensioni 75cm x 50cm
 Peso: 10 kg
 Ruote laterali da 16" (diametro 40 cm)
 Telaio tubolare in acciaio e rivestimento in Nylon 600D



MOD. ERCOLE

Portata massima: 40 kg
 Cassetta in plastica estraibile e pieghevole
 Peso: 13 kg
 Ruote laterali da 16" (diametro 40 cm)
 Telaio tubolare in acciaio
 Cassetta: Plastica



MOD. CAR BIKE 16

Ruote da 16"
 Manubrio pieghevole
 Dimensioni piegata: 63x66x35 cm
 Senza cambio
 Peso: 11,5 kg
 Altezza max sella: 90 cm
 Altezza max manubrio: 95 cm
 Peso max utilizzatore: 100 kg
 Altezza max utilizzatore: 180 cm
 Certificata e omologata UNI EN 14674



MOD. CAR FLEXY 20

Ruote da 20"
 Manubrio e pedali pieghevoli
 Dimensioni piegata: 80x54x30 cm
 Cambio Shimano 6 Velocità
 Con cavalletto
 Peso: 13 kg
 Altezza max sella: 95 cm
 Altezza max manubrio: 100 cm
 Peso max utilizzatore: 100 kg
 Altezza max utilizzatore: 180 cm
 Certificata e omologata UNI EN 14674

GANCI AGGIUNTIVI PER RIMORCHI



PASSANTE CON SGANCIO RAPIDO
 Spazio utile per il mozzo: 155 mm
 Diametro: 5 mm
 Compatibile con: VECTOR, NOTABIKE



PERNO PER MOZZO
 Interamente in acciaio, si fissa sul mozzo della bicicletta
 Compatibile con: LEON, BFOX, FOX, EAGLE, MOVER, CRONO, KORE, ARGO, SNOOPY, ZETA, KUMA, ITER, ACHILLE



ADATTATORI PER MOZZO CON BULLONE
 Coppia di ganci da utilizzare su bici con bullone esagonale che non permette l'inserimento del perno passante.
 Compatibile con: VECTOR, NOTABIKE



GANCIO SOTTOSELLA
 Interamente in acciaio, si fissa sul canotto sottosella
 Compatibile con: GEKO, ERCOLE



GANCIO A MORSA
 Si fissa tramite morsetto al telaio della bicicletta. Consigliato per biciclette elettriche o bici dotate di attacchi che non permettono l'utilizzo del perno tradizionale.



MOD. SANDY

Maniglia retrattile e regolabile
 Telo interno lavabile
 Idrorepellente e resistente allo sporco
 Telo 100% poliestere
 Portata: kg 80
 Ruote anteriori girevoli a 360°
 Dimensioni totali aperto: cm 90 x cm 53 x cm 60
 Dimensioni ripiegato: cm 80 x cm 53 x cm 20
 Lunghezza maniglia di trazione: cm 65
 Spazio di carico: cm 80 x cm 45 x cm 25
 Ruote: diametro cm 20 x larghezza cm 8
 Peso: kg 11 ca



MOD. GEMINI

Maniglia retrattile e regolabile
 Telo interno lavabile
 Materiale idrorepellente e resistente allo sporco
 Telo 100% poliestere
 Portata: kg 80
 Ruote anteriori girevoli a 360°
 Dimensioni totali aperto: cm 108 x cm 108 x cm 53
 Dimensioni ripiegato: cm 80 x cm 53 x cm 20
 Lunghezza maniglia di trazione: cm 65
 Dimensioni copertura: cm 85 x cm 50 x cm 11
 Spazio di carico: cm 80 x cm 45 x cm 27
 Peso: kg 12 ca



MOD. MOON

Maniglia retrattile e regolabile
 Telo interno lavabile
 Materiale idrorepellente e resistente allo sporco
 Telo 100% poliestere
 Portata: kg 80
 Ruote anteriori girevoli a 360°
 Dimensioni totali aperto: cm 90 x cm 57 x cm 53
 Dimensioni ripiegato: cm 74 x cm 53 x cm 30
 Lunghezza maniglia di trazione: cm 65
 Spazio di carico: cm 80 x cm 45 x cm 25
 Peso: kg 10 ca



MOD. FELIX

Capacità: litri 75
 Portata: kg 250 max
 Spessore vaschetta: mm 5
 Dimensioni esterne vasca: cm 95 x cm 50 x 22
 Pneumatici gonfiabili con diametro cm 26
 Peso: kg 14 ca



MOD. GARDY

Ampi pneumatici per facili spostamenti
Ruote anteriori girevoli
Sedile girevole e regolabile in altezza
Portata: kg 150 max
Cestello posteriore e vano porta attrezzi
Peso: kg 15 ca
Dimensioni: cm 85 x cm 45
Ruote: diametro cm x spessore cm 10
Altezza: min cm 45 - max cm 53



MOD. BEST

Novità 2020



MOD. TAKE3

Portata: kg 150 max (distribuita su 3 ripiani)
Ripiano intermedio regolabile su 3 altezze
Dimensioni esterne: cm 84 x cm 41 x altezza cm 78
Dimensioni vasche: cm 74 x cm 39 x altezza cm 8.5
Diametro ruote: cm 10
Peso: kg 12.5 ca



MOD. TAKE2

Portata: kg 100 max (distribuita su 2 ripiani)
Dimensioni esterne: cm 84 x cm 41 x altezza cm 78
Dimensioni vasche: cm 74 x cm 39 x altezza cm 8.5
Diametro ruote: cm 10
Peso: kg 10 ca



MOD. BALTO

Ruota anteriore girevoli a 360 gradi o bloccabile
Freni sulle ruote posteriori
Struttura in alluminio
Impugnatura in gomma resistente
Richiudibile molto velocemente
Abitacolo NON rimovibile
Vassoio con due portabicchieri
Ampio cesto portaoggetti
Robuste finestre a rete
Gancio interno per guinzaglio
Portata massima kg 20



MOD. BOX SMALL

Struttura in alluminio e pannelli in MDF.
Incluso divisorio interno.



MOD. MILO

Ruote anteriori girevoli a 360 gradi
Freni sulle ruote posteriori
Impugnatura in gomma resistente
Richiudibile molto velocemente
Abitacolo rimovibile
Vassoio con due portabicchieri
Ampio cesto portaoggetti
Abitacolo completamente scoperciabile
Robusta finestra a rete
Gancio interno per guinzaglio



MOD. BOX LARGE

Struttura in alluminio e pannelli in MDF.
Incluso divisorio interno



MOD. THUO

Sistema modulare in alluminio
 Seduta reversibile fronte-mamma o fronte-strada
 Schienale reclinabile in ogni posizione
 Ruote anteriori piroettanti o fisse
 Ruote posteriori con freno di stazionamento e sgancio rapido.
 Carrozzina adatta a bimbi fino a 6-7 mesi con fondo areato reclinabile in 3 posizioni.
 Maniglione distanziabile in 3 posizioni
 Seggiolino auto gruppo 0+ (da 0 a 13kg).
 Certificazioni e omologazioni ECE R44/04 Gruppo 0+ EN 1888, ISO 9001-2000



MOD. REBEL

Peso del passeggino: 11 kg
 Schienale del passeggino regolabile
 Sistema di freno a pedale, agisce su entrambe le ruote.
 Peso massimo supportato: 22 kg (oppure 110 cm di altezza)
 Ruota anteriore da 30 cm piroettante o fissa
 Sistema "Easy-fold" per una rapida chiusura
 Ruote posteriori da 40 cm con camera d'aria e sgancio rapido
 Conforme alle normative UNI EN 1888 e JPMA



MOD. JUPY

Sistema modulare in alluminio
 Seduta reversibile fronte-mamma o fronte-strada
 Schienale reclinabile in ogni posizione
 Ruote anteriori piroettanti o fisse
 Ruote posteriori con freno di stazionamento e sgancio rapido.
 Carrozzina adatta a bimbi fino a 6-7 mesi con fondo areato reclinabile in 3 posizioni.
 Maniglione distanziabile in 3 posizioni
 Seggiolino auto gruppo 0+ (da 0 a 13kg).
 Certificazioni e omologazioni ECE R44/04 Gruppo 0+ EN 1888, ISO 9001-2000



MOD. MINIMAXI

Dimensioni aperto: cm 98 x 78 x 47
 Dimensioni chiuso: cm 32 x 32 x 17
 Cestino portaoggetti: cm 24 x 31
 Peso: kg 5.8
 Ruote: diametro cm 10, anteriori piroettanti, posteriori con freno
 Schienale: non reclinabile
 Rivestimento: lavabile a 30°
 Tettuccio parasole
 Per bimbi dai 6 mesi ai 4 anni, (9 - 17 kg).

NON DISPONIBILE



MOD. LONDON

Altezza regolabile da 45 a 56 cm
 Larghezza sedile: 51 cm (spazio interno ai braccioli)
 Profondità seduta: 50 cm
 Altezza schienale: 73 cm
 Diametro base: 58 cm
 Velocemente regolabile in altezza tramite pistone a gas
 Schienale reclinabile fino a 30°
 Meccanismo a dondolo regolabile e bloccabile



MOD. LE MANS

Altezza regolabile da 43 a 51 cm
 Larghezza sedile: 53 cm (spazio interno ai braccioli)
 Profondità seduta: 45 cm
 Altezza schienale: 79 cm
 Diametro base: 64 cm
 Regolabile in altezza tramite pistone a gas
 Meccanismo a dondolo regolabile e bloccabile



MOD. VIENNA

Altezza regolabile da 44 a 52 cm
 Larghezza sedile: 51 cm (spazio interno ai braccioli)
 Profondità seduta: 51 cm
 Altezza schienale: 73 cm
 Diametro base: 67 cm
 Velocemente regolabile in altezza tramite pistone a gas
 Leva per bloccare/sbloccare inclinazione schienale



MOD. MONTECARLO

Altezza regolabile da 49 a 59 cm
 Larghezza sedile: 52 cm (spazio interno ai braccioli)
 Profondità seduta: 50 cm
 Altezza schienale: 77 cm
 Diametro base: 64 cm
 Regolabile in altezza tramite pistone a gas
 Meccanismo a dondolo regolabile e bloccabile



MOD. PRAGA

Altezza regolabile da 49 a 59 cm
 Larghezza sedile: 52 cm (spazio interno ai braccioli)
 Profondità seduta: 50 cm
 Altezza schienale: 71 cm
 Diametro base: 67 cm
 Velocemente regolabile in altezza tramite pistone a gas
 Braccioli sollevabili



MOD. MONZA

Altezza regolabile da 45 a 56 cm
 Larghezza sedile: 49 cm (spazio interno ai braccioli)
 Profondità seduta: 49 cm
 Altezza schienale: 76 cm
 Diametro base: 67 cm
 Regolabile in altezza tramite pistone a gas
 Leva per bloccare/sbloccare inclinazione schienale



DIMENSIONI



LEON

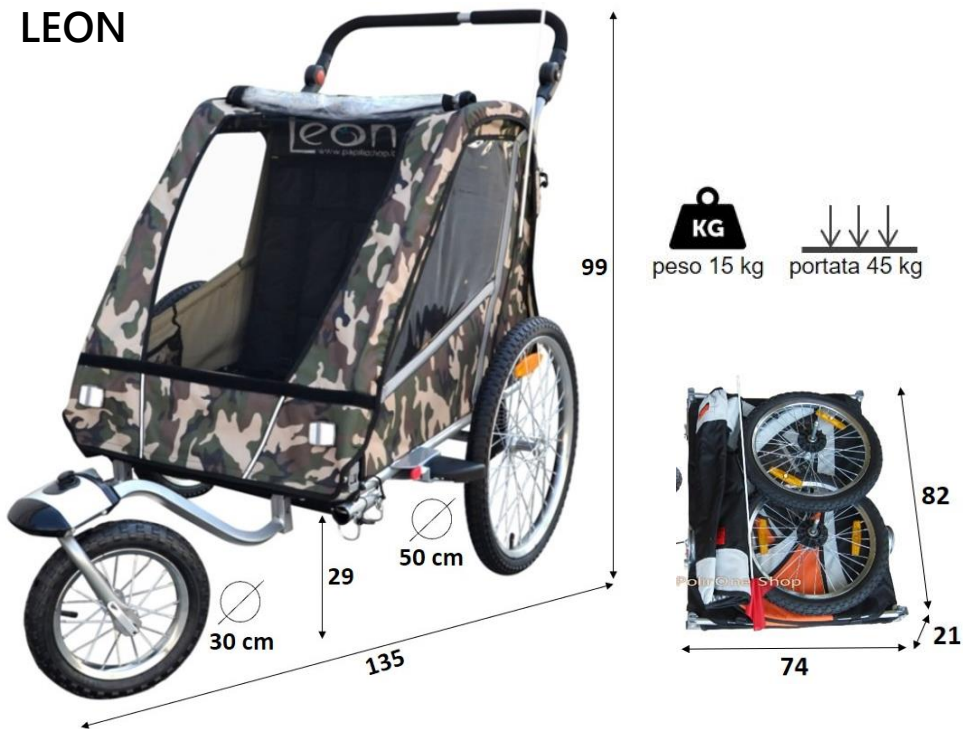

EAGLE

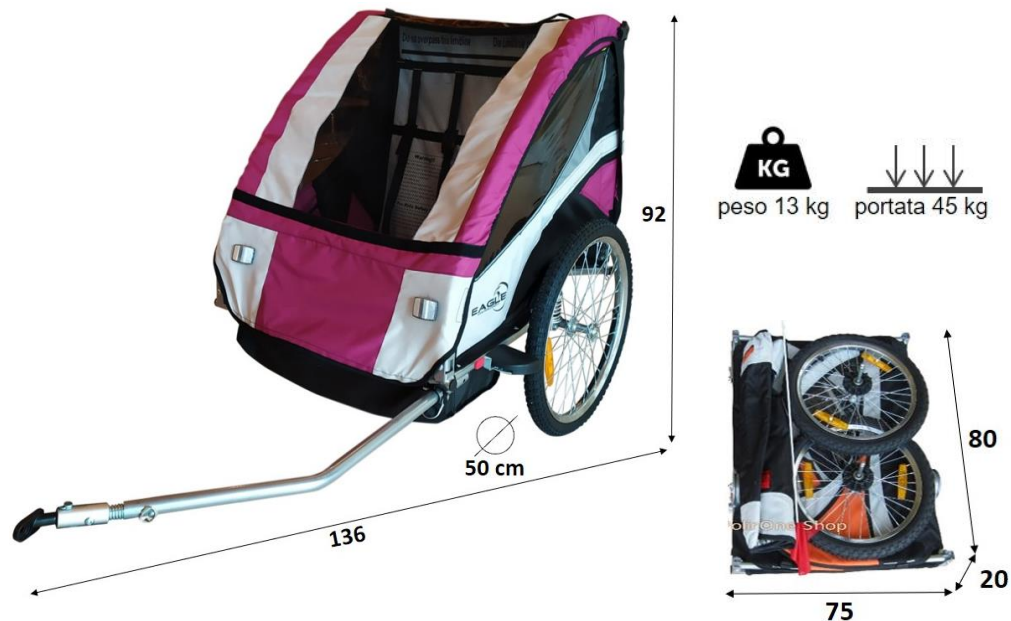

DIMENSIONI



B-FOX



MOVER



DIMENSIONI



CRONO



KORE



DIMENSIONI



FOX



KG
 peso 13 kg portata 40 kg



KUMA

KG
 peso 11 kg portata 25 kg



DIMENSIONI ARGO



SMALL



MEDIUM



LARGE



KG
peso 13 kg portata 25 kg



KG
peso 15 kg portata 35 kg



KG
peso 15 kg portata 45 kg



DIMENSIONI SNOOPY



SMALL



MEDIUM



LARGE

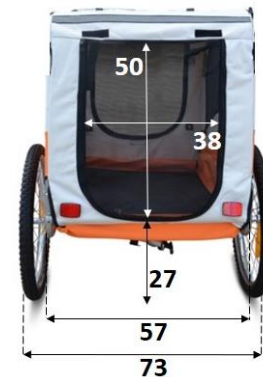

DIMENSIONI ZETA



SMALL



KG
peso 13 kg portata 25 kg



MEDIUM



KG
peso 15 kg portata 35 kg



LARGE



KG
peso 15 kg portata 45 kg



DIMENSIONI

VECTOR

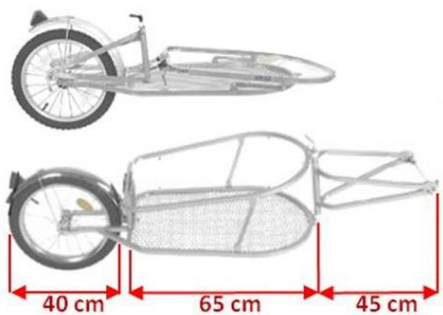
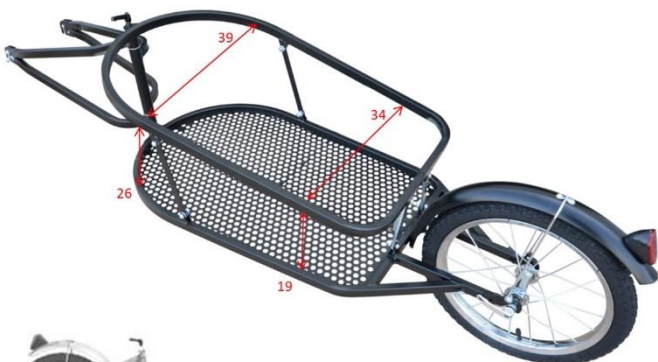

ACHILLE



15 kg

ITER



ITER



DIMENSIONI



NOTABIKE

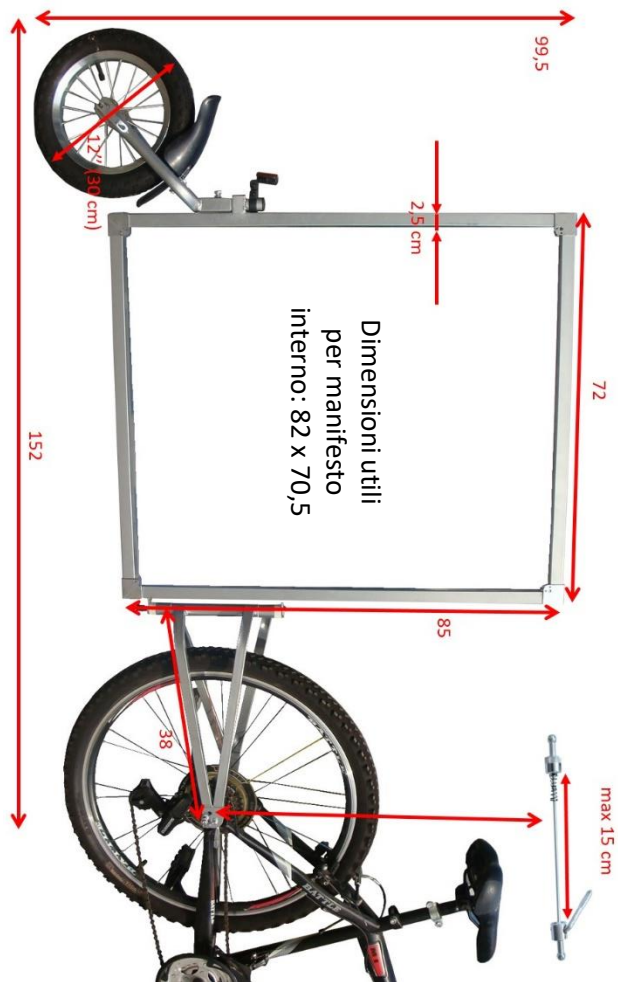

GEKO



ERCOLE

Larghezza complessiva (con ruote) 60 cm
portata 40 kg

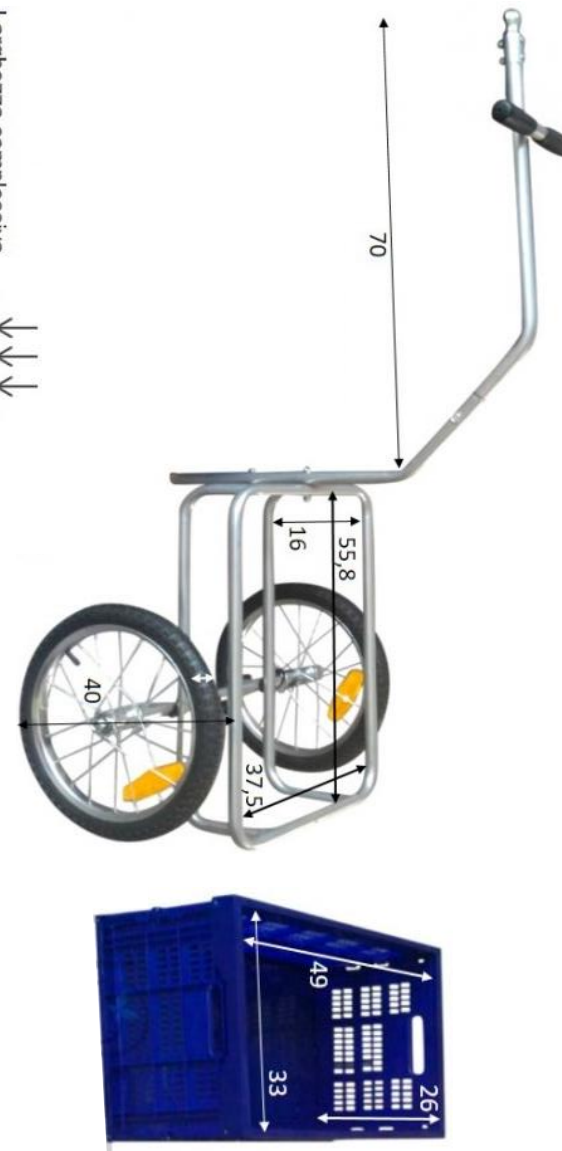

DIMENSIONI

BALTO



MILO



BOX



DIMENSIONI

THUO



JUPY



DIMENSIONI



REBEL



MINIMAXI





Via Ferri, 138/c - 46027 San Benedetto Po (MN)
P. IVA 02252900200 C.F. CSTPLA77B48E897W
Tel. 0376-414066 393-2834704 393-5305228
www.polironeshop.it info@polironeshop.it

