

SHAD

YAMAHA MT 03 '21

YOMT31IF

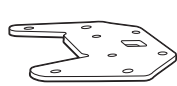

1 262723 x1

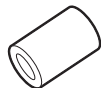

2 260641 x2
Ø16 Ø9 x 22



3 260596 x2
Ø16 Ø9 x 20

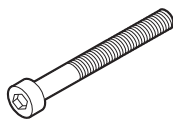

4 304178 x4
M6 x 60 Din 912



5 303017 x9
Ø6

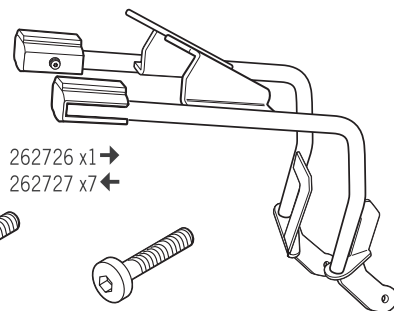

6 262726 x1 →
262727 x7 ←



7 302021 x4
M6

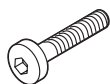

8 304053 x4
M8 x 30
Din 7380



9 303045 x10
Ø8



10 302024 x5
M8



11 260648 x4
Ø16 Ø9 x 5

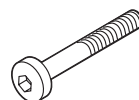

12 304069 x1
M8 x 55
Din 7380



13 304079 x1
M6 x 30
Din 7380



WARNING!

(GB) Do not fully tighten the screws until it is ensured that the KIT is correctly attached and aligned.

(E) No apretar los tornillos del todo hasta asegurarse que el KIT está correctamente colocado y alineado.

(D) Ziehen Sie die Schrauben nicht ganz fest, bevor Sie sich nicht vergewissert haben, daß der Bausatz korrekt eingestellt und ausgerichtet ist.

(I) Non stringere del tutto le viti fin tanto non si è sicuri che il kit è collocato correttamente e allineato.

(F) Ne pas serrer les vis avant d'être sûr que le KIT soit correctement positionné et ajusté.

ATTENTION: For a complete set of equipment, mount the TOP bracket above the stand (1).

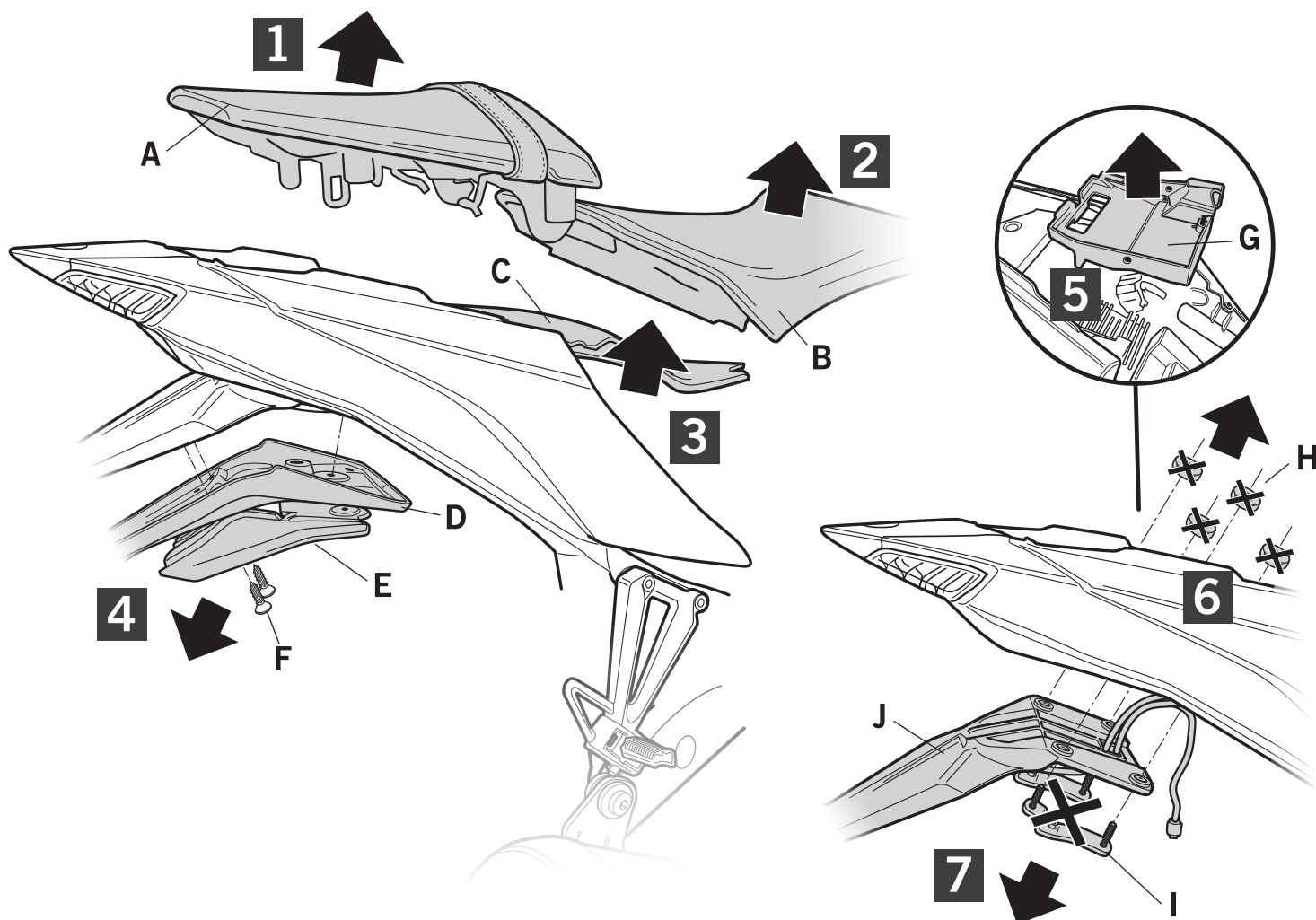

IMPORTANT: Based on European models. For compatibility with models in other continents, check www.shad.es

