

Owner's Manual

TR1200i Color
Folding Treadmill

Congratulations on Purchasing Your LifeSpan Treadmill!

At LifeSpan we take pride in the quality, safety, and reliability of our products as well as the professionalism of our sales support and customer service teams. Making it our number one priority that you have an exceptional experience using our products.

In support of this quality focus we pre-assemble parts on the manufacturing line whenever possible to reduce the number of steps and complexity of customer assembly, independently certify our products to comply with the latest industry Safety Standards, and use state of the art production processes and quality components.

Then we back LifeSpan products with excellent warranties and a responsive customer service department making it simple and easy to get assistance should the need arise.

This attention to quality, our high standard for customer service and focus on innovation has earned LifeSpan numerous awards and consistent praise from independent review groups, industry authorities and you the consumer.

Thanks for choosing LifeSpan.

Please thoroughly read this manual before you assemble or operate your treadmill. Neither LifeSpan nor its representatives can accept responsibility for any damages or injury incurred as a result of information presented in this manual except under the terms of the product warranty.

Welcome

Safety First.....5

Safety Tips

Safety Key

Grounding

Assembling Your Treadmill..... 10

Exploded View & Hardware

Assembly Instructions

Console Basics 18

Console Overview

Display and Keyboard

Operations 25

Home Screen and Personal Settings

Bluetooth, Heart Rate Strap Set-up

QuickSTART and Manual

Preset Programs

Custom User Set-Up Programs

Heart Rate Control Programs

Summary

Equipment Settings

Program Profiles

Maintenance and Tips..... 50

Heart Rate Monitoring

Cleaning / Lubrication

Folding & Unfolding

Moving

Belt Tensioning

Belt Alignment

Troubleshooting

About Your Treadmill..... 59

Unique Features

Specifications

Warranty / Registration

When using exercise equipment, basic precautions should always be followed, including:

- Never drop or insert any object into any opening. If an object falls into an opening, turn the power off and unplug the power cord from the outlet. Remove the object or call customer service at 801-973-9993 x4.
- Never operate this treadmill if it has been damaged or partially submersed in water.
- To reduce the risk of electric shock, unplug the treadmill from the wall outlet when not in use, before performing any maintenance, or before moving the treadmill.
- Do not use outdoors or in areas of high humidity or extreme temperature changes.
- Do not lean against or climb on the treadmill.
- Do not operate where aerosol spray products are being used or where oxygen is being administered.
- Never place the power cord under carpeting or place any object on top of the cord, this may pinch or damage the cord causing fire damage or personal injury.
- Use this exercise product for its intended use as described in this Owner's Manual. Do not use attachments that are not recommended by LifeSpan.
- Do not leave your treadmill running while not in use.

Children and Pets

- Keep children from playing on your treadmill at all times.
- When in use children and pets should be kept at least 10 feet (3m) away.
- This treadmill can be used by children ages 12 years and above and persons with reduced physical, sensory or lack of experience and knowledge if they have been given supervision or instruction concerning use of the appliance in a safe way and understand the hazards involved.
- Cleaning and user maintenance shall not be made by children without supervision.

Safety First

Safety Tips While in Use

- Always consult a physician before beginning an exercise program.
- If you experience chest pains, nausea, dizziness or shortness of breath, stop exercising immediately and consult your physician before continuing. Do not wear clothing or jewelry that might catch on any part of the treadmill.
- Wear shoes with high traction rubber soles. Do not wear shoes with heels, leather soles, cleats or spikes.
- In case of emergency, grab onto the side handrails and place your feet on the side rails located on each side of the running belt.
- Do not walk or run backwards on the treadmill, always face forward.
- Allow the running belt to fully stop prior to getting off the treadmill.
- Keep the treadmill on a solid surface, with the side rails and front of the treadmill a minimum of 2 feet (0.6m) from any walls or furniture. Make sure that the area behind the treadmill remains completely clear during use. A minimum of 7 feet (2m) of clearance is required for safety reasons.

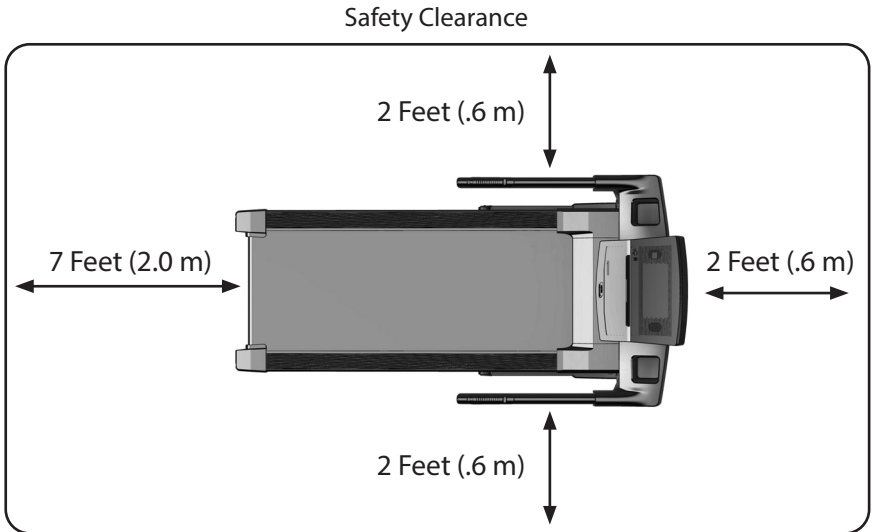

Safety Key

The safety key is required to operate this treadmill. With the safety key installed the treadmill is operational. With the safety key pulled, power is turned off to the motor making the treadmill inoperable.

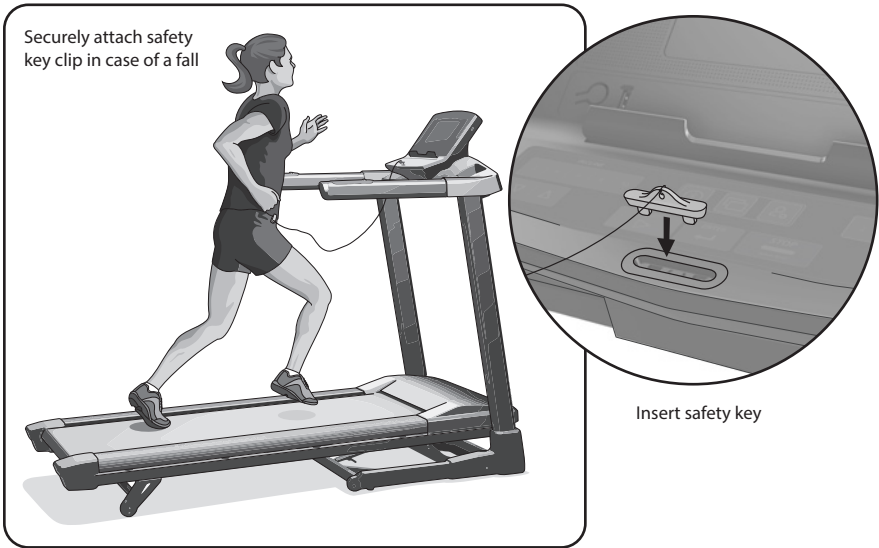

! **CAUTION:** For your safety always attach safety key clip to an article of clothing prior to use. The safety key clip needs to be securely attached to clothing parallel to or above the height of the safety key.

! **WARNING:** Heart rate monitoring systems may be inaccurate. Over exercising may result in serious injury or death. If you feel faint stop exercising immediately.

NOTE: Read all instructions and save for future reference.

Safety First

Proper Grounding

LifeSpan equipment must be grounded. Improper connection of the equipment's grounding conductor can result in the risk of electric shock. Check with a qualified electrician or service person if you are in doubt as to whether the outlet is properly grounded. Do not modify the plug provided with the product or use a ground plug adapter to adapt to a non-grounded outlet. If the plug will not fit in the outlet, have the proper outlet installed by a qualified electrician.

Power Cord Options

This treadmill should only be used with the proper power cord and power outlet. Several power cord options (shown below) are available from LifeSpan. We do our best to include the correct power cord with the treadmill for your area. In the event that the correct power cord is not included in the packaging please contact your local distributor.

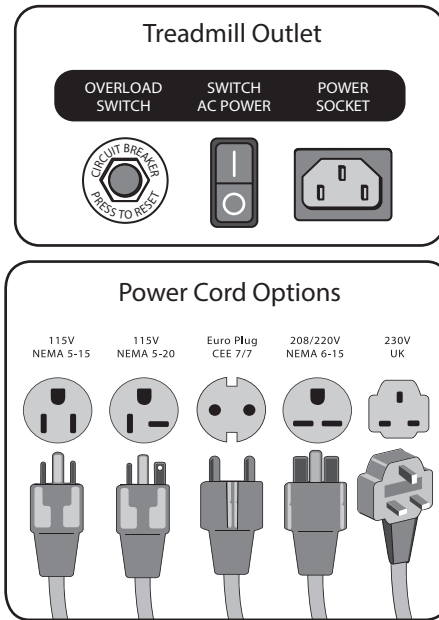

- ⚠ Do not use extension cords between the treadmill and power outlet.
- ⚠ Do not plug into a GFI outlet or circuit as it may trip the breaker.

Assembling Your Treadmill

Exploded View

Prior to starting the assembly process take all of the parts out of the box. Remove plastic bags and lay them out on the floor to become familiar with the components.

Since your treadmill is a heavy piece of equipment it is recommended you use two people during assembly and follow these assembly instructions to reduce any problems that could occur.

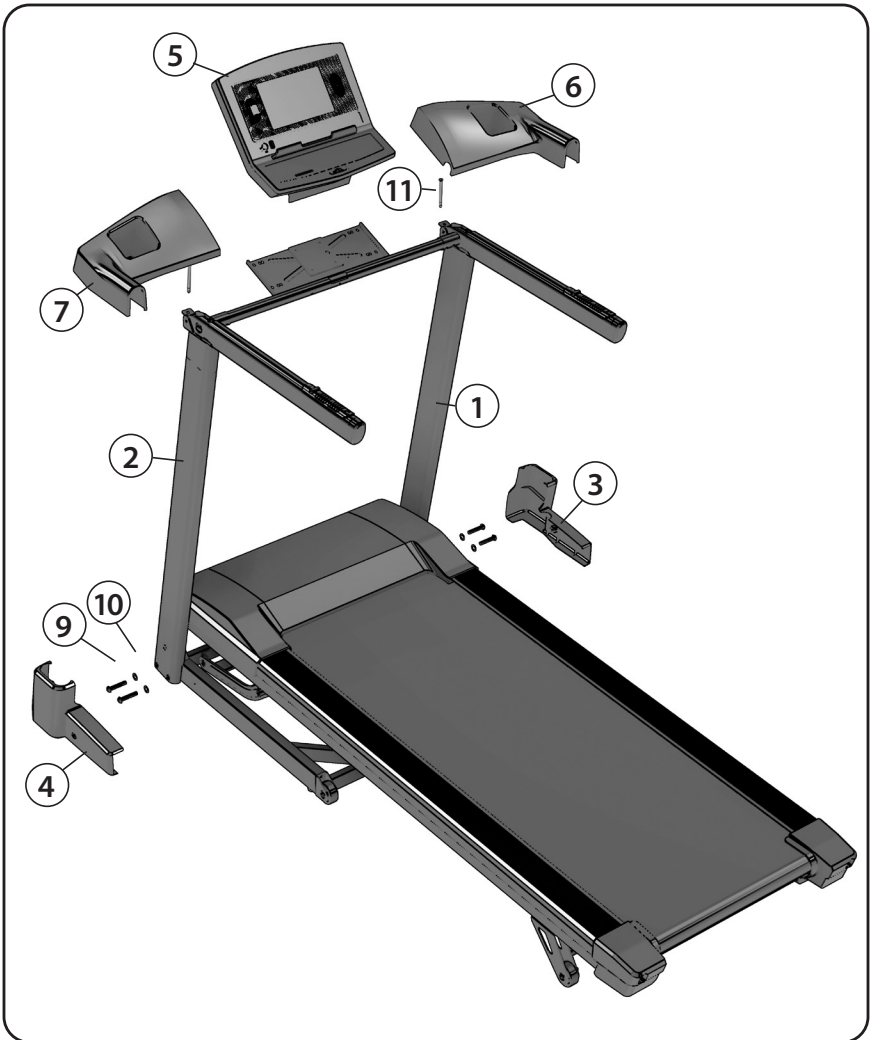

Assembling Your Treadmill

Hardware Included

Item#	Part Description
1	Right Upright Post
2	Left Upright Post
3	Right Upright Post Cover
4	Left Upright Post Cover

Item#	Part Description
5	Console
6	Right Cup Holder
7	Left Cup Holder

Hardware Bag Contents

Item #	Qty.	Hardware Description
N/A	1	6mm Allen Wrench
N/A	1	5mm Allen Wrench with Phillips Screw Driver
9	4	M10 x 45L Bolt - (<i>Upright Post Attachment</i>)
10	4	M10 Washer - (<i>Upright Post Attachment</i>)
11	2	M8 x 70L Bolt - (<i>Handlebar Attachment</i>)

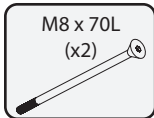
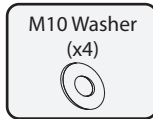
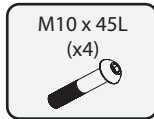
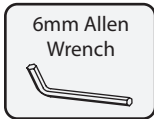

Pre-installed Hardware (*not shown*)

Item #	Qty.	Hardware Description
12	2	M4 x 8L - Screw (<i>Upright Cover Attachment</i>)
13	4	M4 x 10L Screw - (<i>Console Attachment</i>)
14	6	#8 x 5/8" L Screw - (<i>Cup Holder Attachment</i>)
15	4	M8 x 15L Bolt- (<i>Mounting Bracket</i>)
16	4	M8 Washer - (<i>Mounting Bracket</i>)

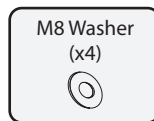
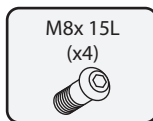
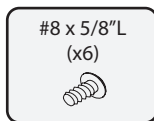
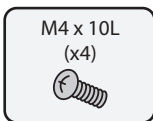
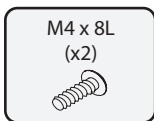

Assembling Your Treadmill

Step 1: Unpacking Treadmill

- A. Cut packaging straps and remove.
- B. Remove the box top.
- C. Remove small parts and packaging material and unwrap parts.
- D. Cut the corners of the bottom box and remove all packaging material to begin assembly. The treadmill can be assembled in the box. No need to pick the treadmill up to remove it from box.

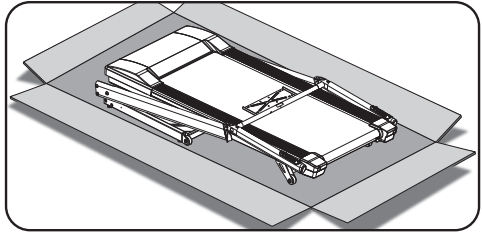

Step 2: Upright Post Attachment

- A. Carefully fold the uprights with handlebars up into the upright position.
- B. Carefully lay handlebars down as the uprights are brought up into position. This will protect against any accidental damage to wires coming up through the upright into the handlebars.
- C. Align the holes in the lower portion of the upright with the threaded holes in the frame.
- D. Install the four M10 x 45L Bolts(9) and M10 Washers(10), two in each upright. The best way to handle this is to loosely install all four bolts and washers and then tighten once all bolts are installed.

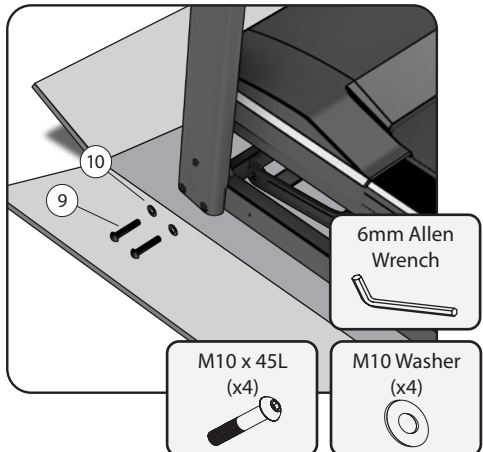
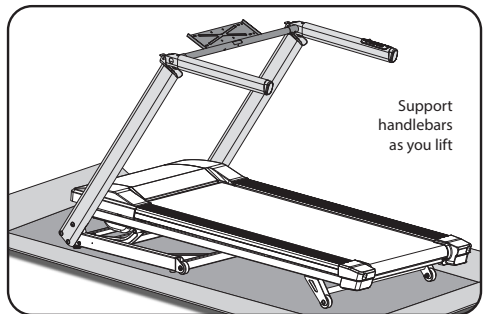

Assembling Your Treadmill

Step 3: Upright Post Cover Attachment

- A. Remove pre-installed M4 x 8L Screw(12).
- B. Install the Left Upright Cover(4) by sliding the front of the cover around the upright and centering or aligning the cover on the upright.
- C. Install the M4 x 8L Screw(12).
- D. Repeat steps A and B for the right upright cover.

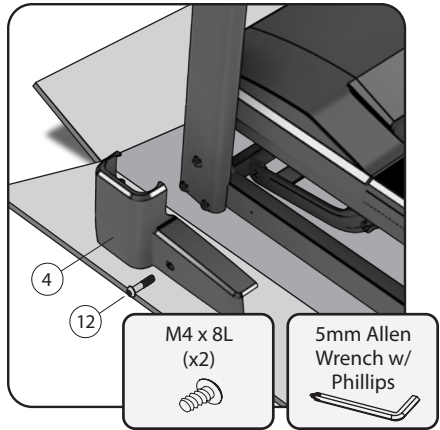

Step 4: Handlebar Attachment

- A. Place the M8 x 70L Bolt(11) through the left handlebar and into the uprights being careful not to damage any wires running through the handlebar. Repeat for the right handlebar.
- B. Loosely thread both bolts into the upright prior to tightening.
- C. Fully tighten both handlebar attachment bolts.

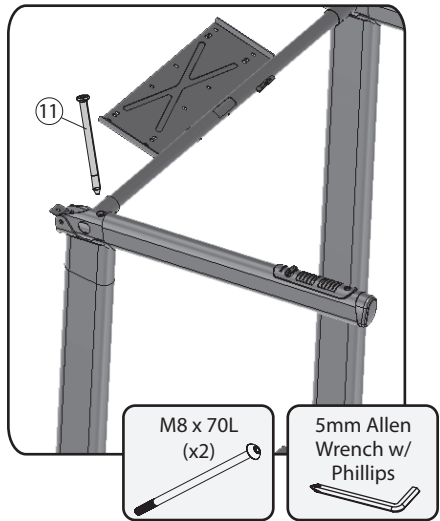

Assembling Your Treadmill

Step 5: Console Attachment

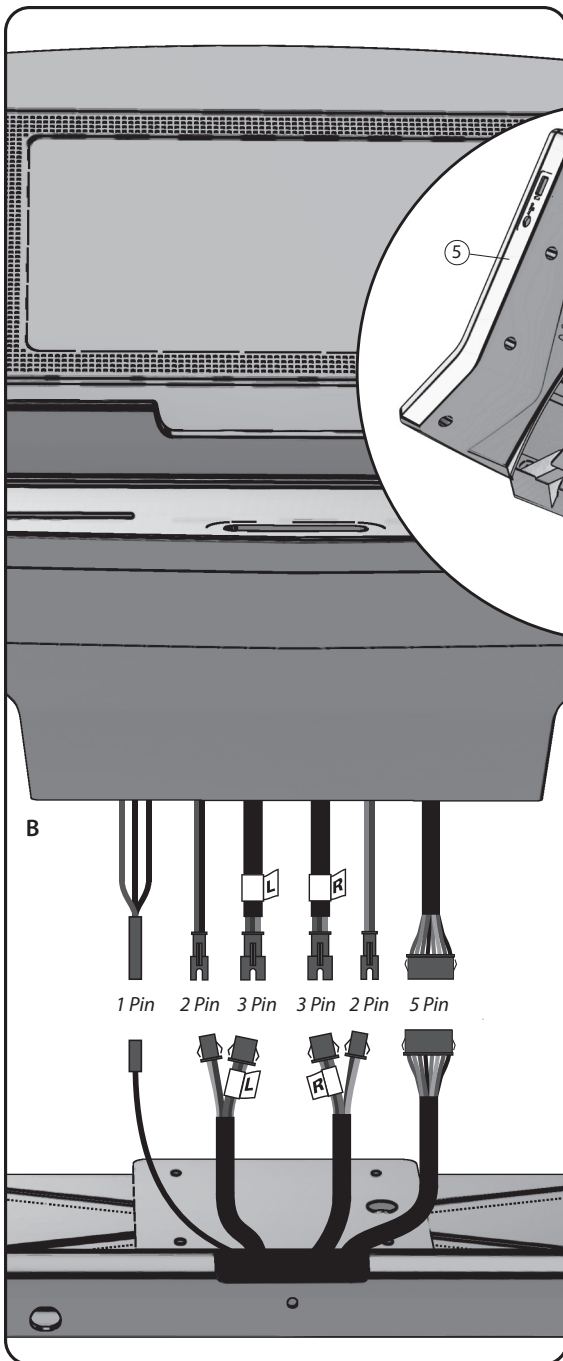

A. Remove the four M4x10L Screws(13) from the bottom of the Console(5).

- B. Connect the five cable connectors as follows:
1. Connect the 5-pin main wire harness
 2. Connect the two 3-pin cable connectors L to L and R to R.
 3. Connect the two 2-pin cable connectors. It does not matter which ones you connect.
 4. Connect the one 1-pin cable connectors.

Assembling Your Treadmill

- C. Carefully tuck all wires into the bottom of the console housing and set the console down on the mount bracket.
- D. Loosely install all four M4x10L screws(13), then tighten.

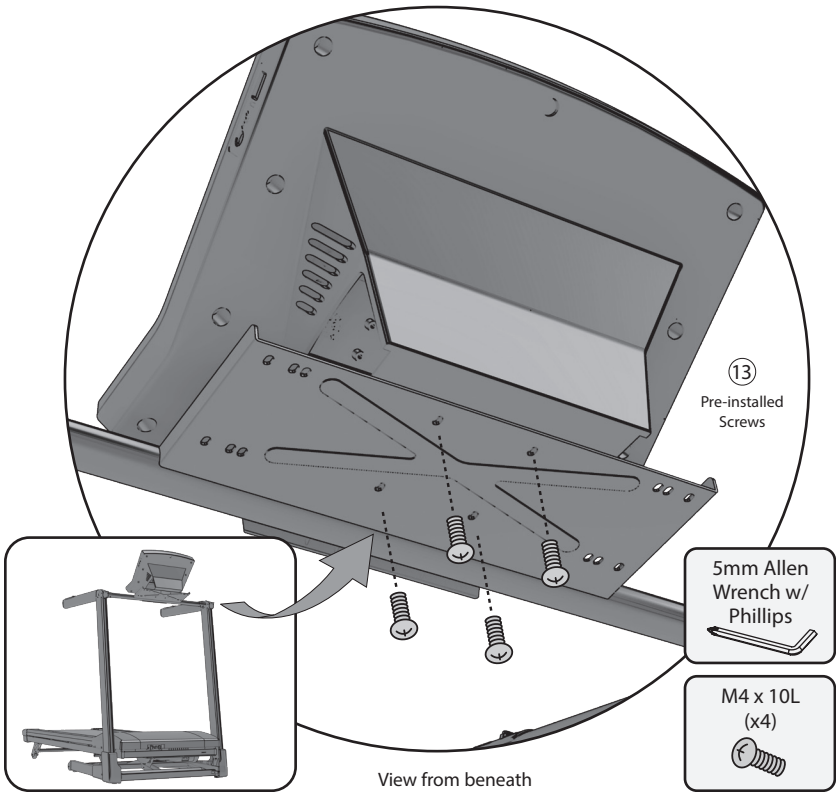

Assembling Your Treadmill

Step 6: Cup Holder Attachment

- A. Remove the three pre-installed #8 x 5/8" L Screws(14) with the provided Phillip's head screwdriver from the bottom of the right cup holder.

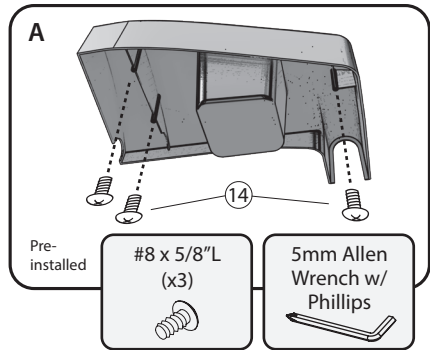

- B. Place the Right Cup Holder(6) over the handlebar and into the frame as shown.

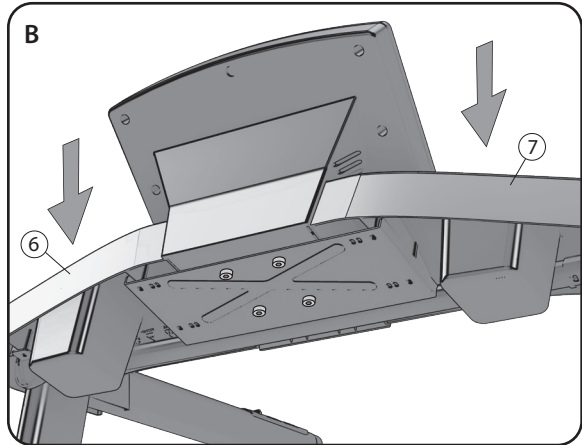

- C. Loosely install the three screws removed in step A. Once all screws are installed, securely tighten them.
- D. Repeat steps A through C for installing the Left Cup Holder(7).

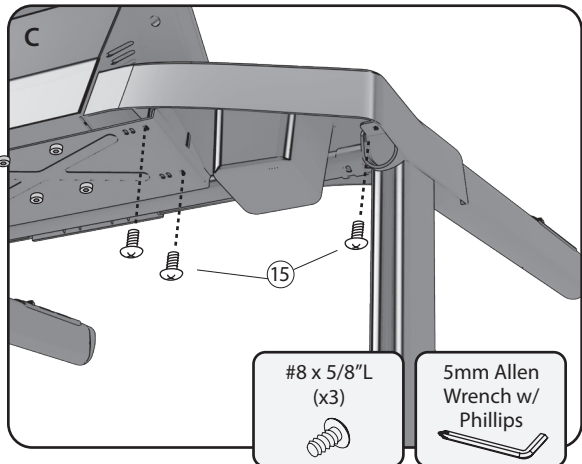

Assembling Your Treadmill

Step 7: Tighten Console Assembly

- Make sure the console and the cup holders are fitting properly on the Mounting Bracket.
- The Mounting Bracket may have rotated a little during assembly. If needed, slowly rotate the console assembly forward until the cup holders align and rest on the handlebars.
- Tighten the four M8 x 15L Bolts(15) and M8 Washers(16) under both sides of the console tube.

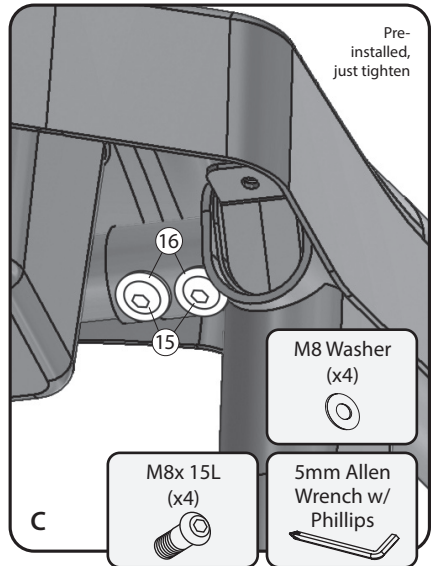
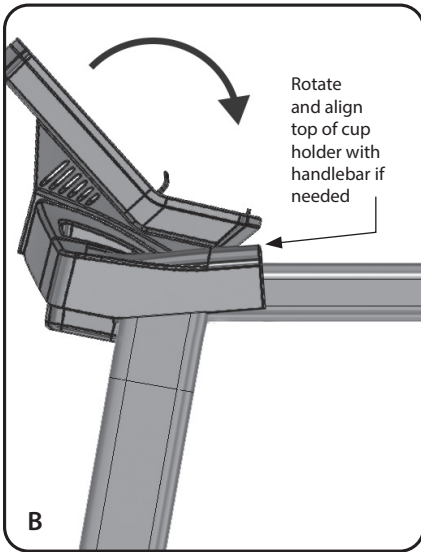

Step 8: Remove Shipping Strap

- Cut plastic shipping strap holding deck frame to base.

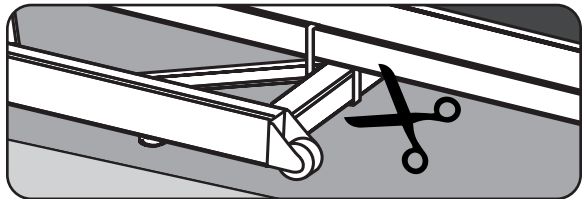

WARNING: To avoid personal injury, never attempt to pick the treadmill up and carry it from this position once this strap is cut. The treadmill should be folded and rolled to the new location or folded and carried to the new location.

Console Basics

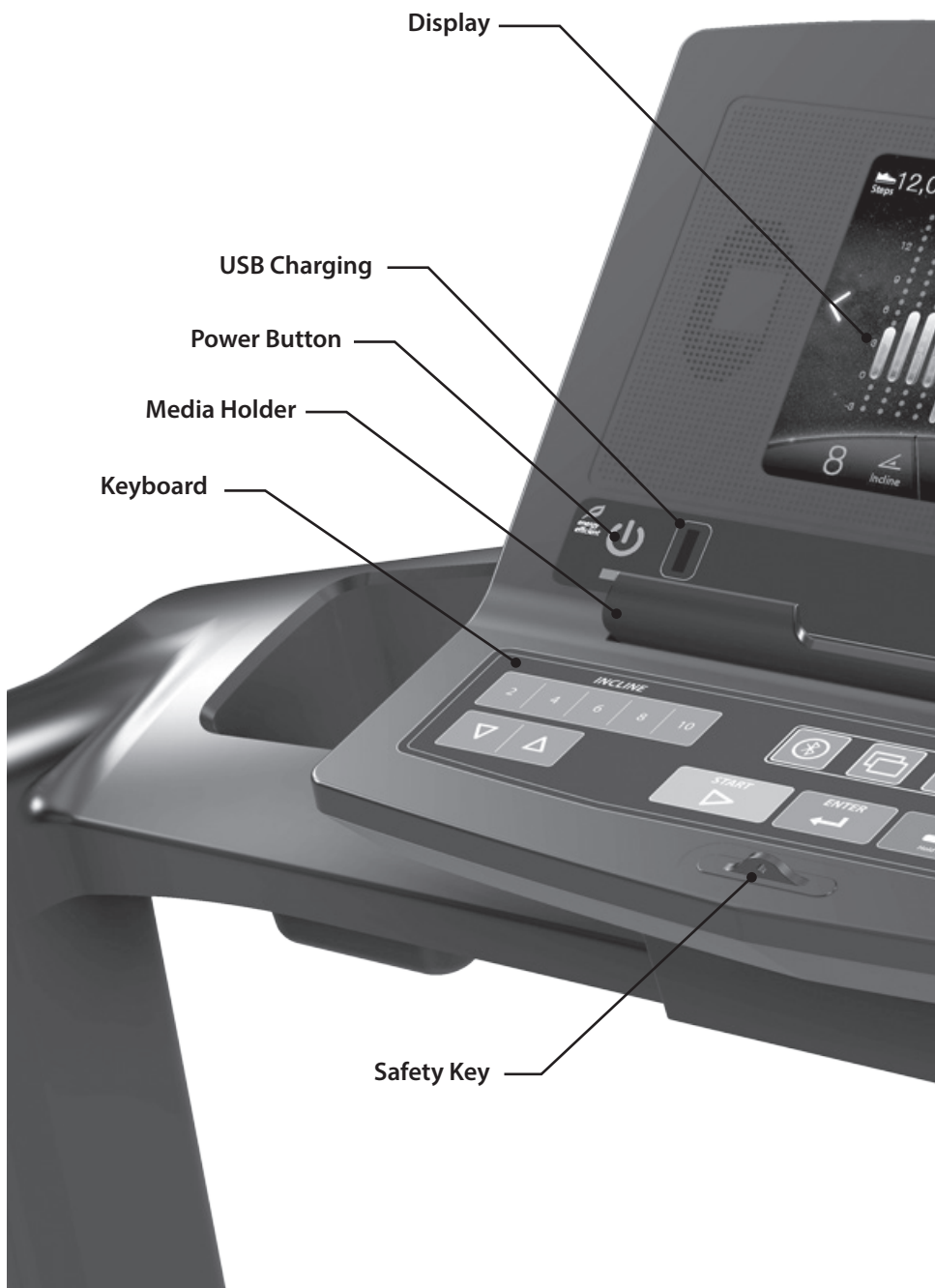

Console Basics



Console Basics

Readout Display

A TFT display provides all the information you need to monitor your exercise results and get the most out of your exercise program. Swipe between one of three screens to view your results.

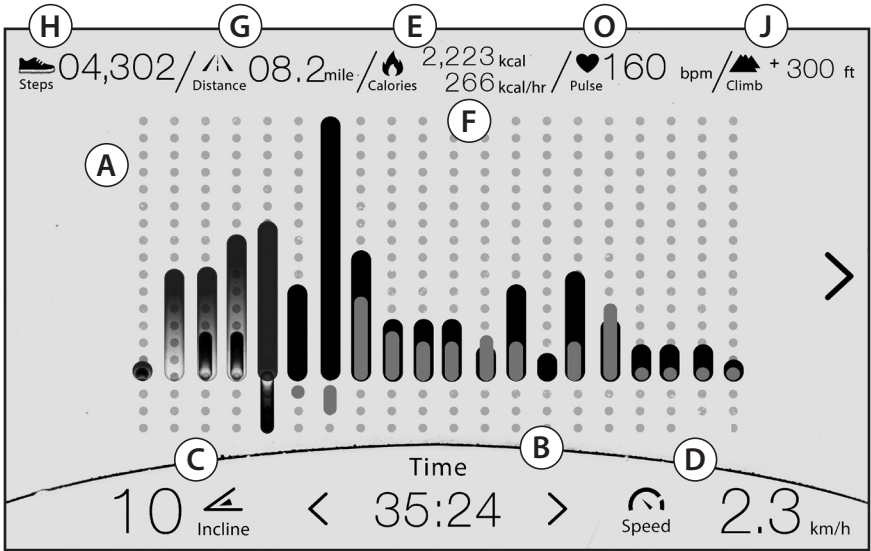

Screen Option 1

- A. **Program Matrix** - Divides the workout programs into 20 segments with varying intensity levels. These programs can be viewed in levels of incline, speed or both.
- B. **Time** - The workout time elapsed or the workout time remaining.
- C. **Incline** - TR1200i incline range is 0 to +15.
- D. **Speed** - The speed you are traveling in miles per hour (this reading can be changed to kilometers by using the Personal Settings Mode).
- E. **Calories** - Estimated calories burned is calculated by using a widely-accepted equation, using body weight and distance covered.
- F. **Calories/Hour** - Number of calories burned per hour.

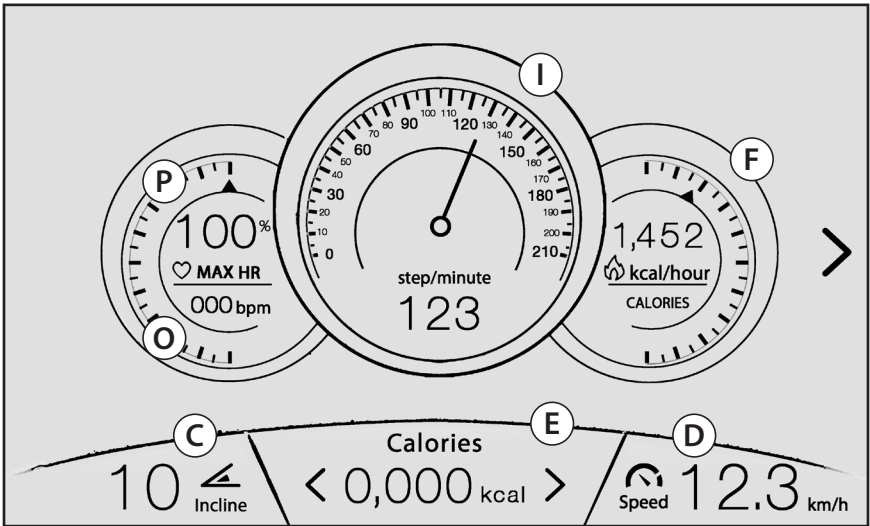

Screen Option 2

- G. **Distance** - Total distance traveled in miles or kilometers since the beginning of the workout.
- H. **Steps** - Works like a pedometer, counting your steps while you walk.
- I. **Steps/Minute** - Current number of steps being walked per minute
- J. **Feet/Meters Climb +** - This is the total feet or meters up (based on incline) that you have climbed.

Console Basics

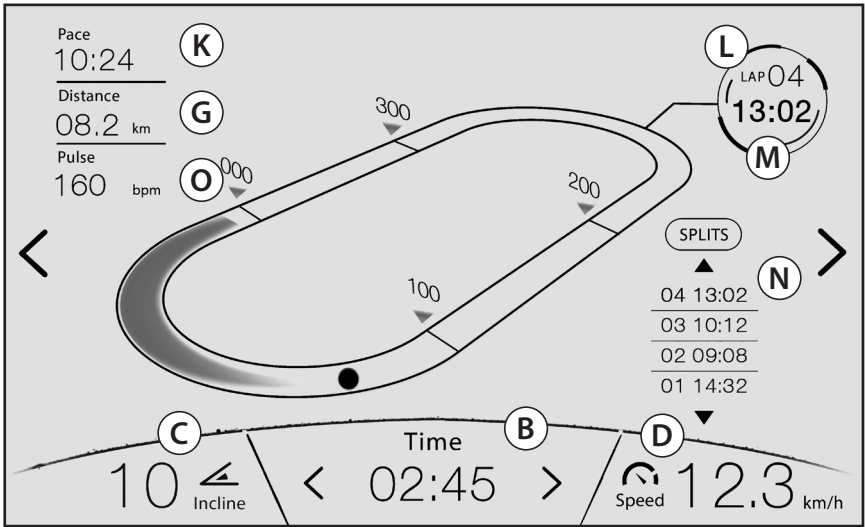

Screen Option 3

- K. **Pace** - The number of minutes it takes to complete a mile or kilometer.
- L. **Lap** - The number of 400 meter laps completed on a track.
- M. **Lap Time** - Current lap time.
- N. **Splits** - These are one lap splits. In this case a split is the time it took to complete a lap.
- O. **Heart Rate** - Your measured heart rate using the hand pulse sensors located on the front handlebars, chest strap, or armband.
- P. **% Max Heart Rate** - This is the percentage of your suggested max HR (220 - age).

Indicator icons:



Lube - Every 50 hours of use a pop-up window with a message to lubricate the treadmill belt will show up. This will happen once at 50 hours with the opportunity to choose “Remind me later” or “Done”. **Press stop for remind me later, or enter for done.** If remind me later is chosen, the pop-up will show up again after another hour, with the same options. Once 55 hours is reached a pop-up will show up every time the home screen is displayed, until Done is selected. (Please refer to the Maintenance and tips section for lubrication instructions)



CAUTION: The Intelli-Guard feature will automatically be disengaged when the treadmill is operated at speeds under 1.0 mph (1.6 kph). If the speed is within this parameter “Step” will flash. When the “Step” is flashing, the treadmill will not automatically pause. If the speed is above 1.0 mph (1.6 kph) Intelli-Guard™ will not activate until 30 steps are taken and counted.



CAUTION: At 20 seconds the console will beep once per second for 5 seconds and then automatically pause the treadmill. These beeps are a notice that the treadmill belt is about to stop. If for some reason you are still on the treadmill when this occurs, move your feet to the side rails and prepare for the belt to stop. The Intelli-Guard feature does not replace the use of your Safety Key or using proper precaution in stopping the treadmill when it is not in use.

Console Basics

Main Keyboard

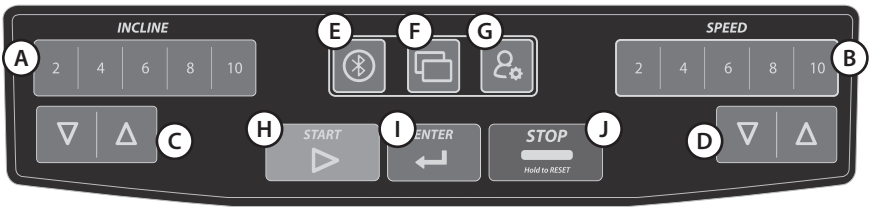

- A. **Quickset™ Incline** - Select an incline level of 2, 4, 6, 8 or 10.
- B. **Quickset™ Speed** - Select a speed of 2, 4, 6, 8, 10 mph (2, 4, 6, 8, 10 kph).
- C. **Incline** - Raise and lower the running belt incline.
- D. **Speed** - Increase or decrease belt speed. Press once for 0.1mph/kph increments.
- E. **Bluetooth** - Pair your Bluetooth chest strap.
- F. **Change Display** - Change between the 3 main display screens during a workout. Used to move through main options or groups during program setup. This is a main program setup button.
- G. **Personal Settings** - Takes you to the personal settings page.
- H. **Start** - Start the treadmill.
- I. **Enter** - Use to select or save adjustments made during program setup. On the main display screen during your workout, press to change between time, calories or steps.
- J. **Stop** - The Stop button will pause your workout, taking you to a pause screen. Pressing stop twice takes you to a summary screen. Pressing and holding stop resets the console.

Top Keyboard



- A. **Power** – This button can be used to turn the console “on” from Energy Saving mode and to turn the console “off” when in Standby mode.
- B. **USB Charging Port** - Charges most mobile devices.

NOTE: Make sure the main on/off switch, located at the front of the treadmill base (near the floor) is on.

Home Screen



Use your phone's camera to scan this QR code for a how-to video.

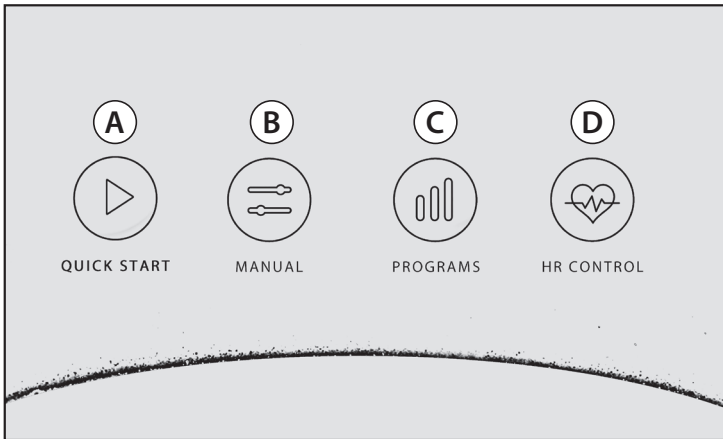



- A. **QuickSTART** - This is a manual program that allows you to start and use whatever incline or speed you want for as long as you want to work out.
- B. **Manual** - This program allows you to set a desired workout time as well as setting age and weight for an accurate calorie count and % max HR readings.
- C. **Programs** - These are preset programs where the console will control either speed or incline and you will control the other. You can choose whether you want the console to control incline or speed and then update weight, age and override the default program time if desired.
- D. **HR Control** - There are two Heart Rate Control programs to choose from. Constant Heart Rate allows you to select a Constant Heart Rate for the console to adjust Speed or Incline (you get to choose whether the console controls speed or incline) to keep your Heart Rate at that constant number throughout the entire program. Interval Heart Rate Control allows you to select a high heart rate and a low heart rate. Again, you determine whether the console is to control the speed or the incline to get your HR to the desired numbers. The program will get your heart rate to the high number and keep it there for 2 minutes and then to the low number and keep it there for two minutes. The programs adjusts speed or incline to raise and lower your heart rate to the high and low numbers till the program time is finished. It is best to select a workout time of at least 30 minutes for best results.

Operations

Personal Settings

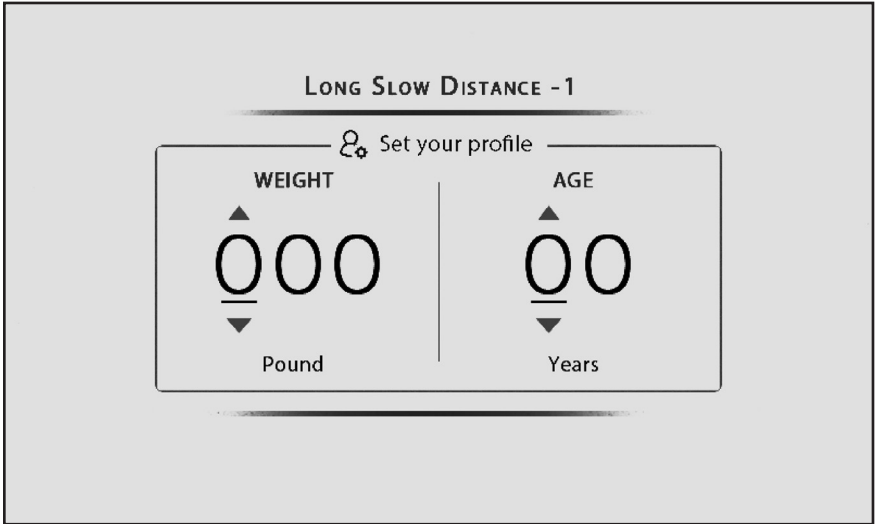
The TR1200i comes with the ability for you to personalize several console settings. To make adjustments to your personal settings, simply press the  button on the keypad.



1. **Weight** - Adjust your weight using the ▲/▼ buttons.
2. **Age** - Press the  button to switch to age. Adjust your weight using the ▲/▼ buttons.

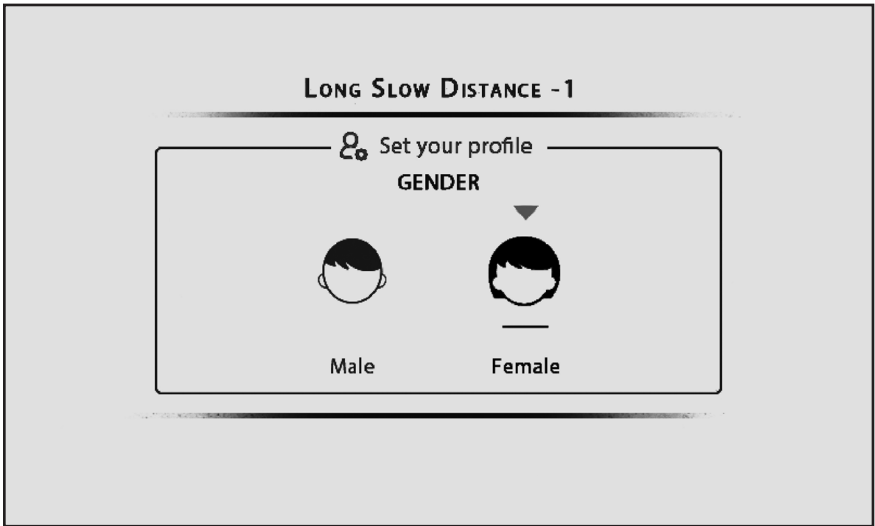

3. **Gender** - Press the  button. Select male or female using the ▲/▼ buttons. Press Enter. Press stop for three seconds to go back to the main page.

Operations

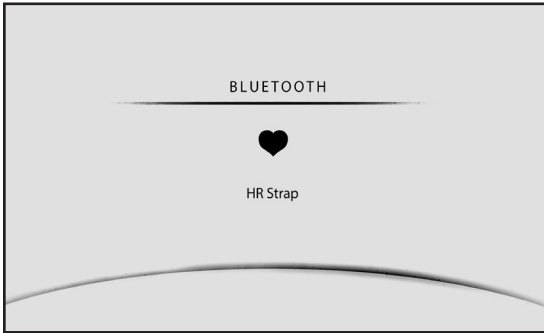

To Set up your
Bluetooth Heart
Rate Chest Strap:

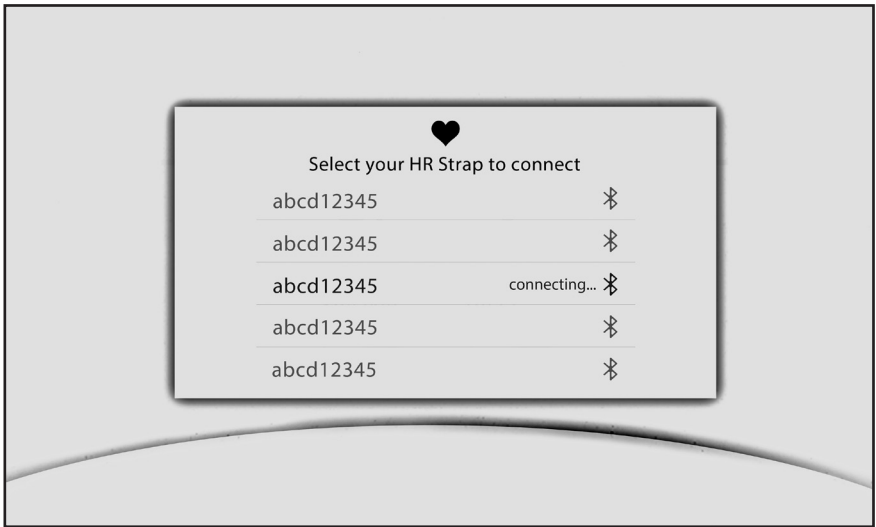

Bluetooth Heart Rate Screen Step 3

If you have purchased a Bluetooth Heart Rate Chest Strap or Arm Band from LifeSpan, the device should automatically connect based on proximity to the console. If for some reason a connection isn't found or for those using a Bluetooth device not purchased from LifeSpan please follow these steps:

1. Press the Bluetooth button.
2. A pop-up screen showing active Bluetooth devices will be displayed.
3. Select your Bluetooth device using the ▲/▼ buttons and press enter.
4. The screen will show Connecting. Once connected the screen will go away.

Quick Start

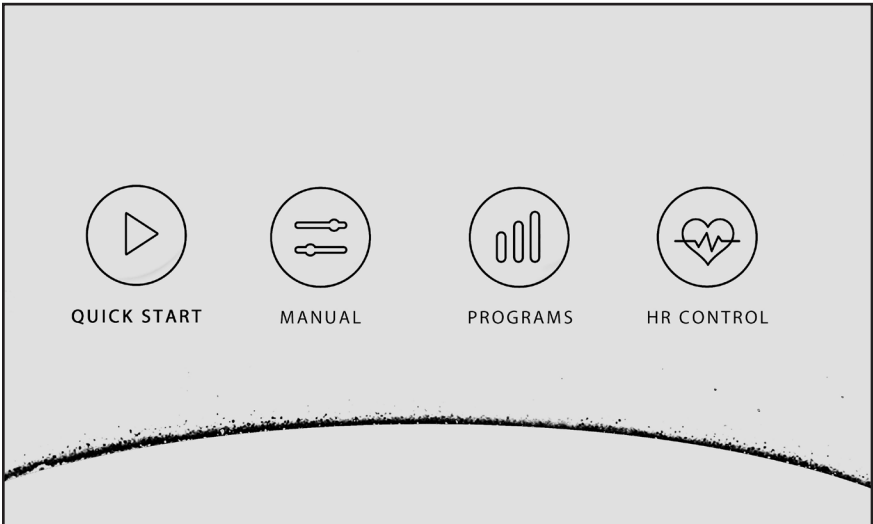

To just start working out without any setup, simply press the green START button.

When using QuickSTART, the time will count up from 0:00 keeping you fully in control of the speed and incline. When finished press Stop to go to the summary screen.



Operations

Manual Program

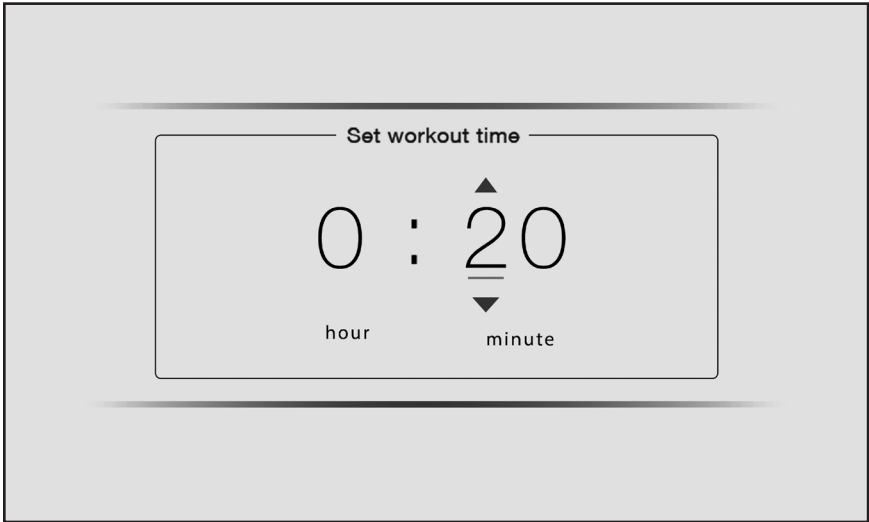
This is very similar to the QuickSTART program, but with this program you can set a workout time and setup personal settings to be sure to get an accurate calorie count. The program will end when your set time has been reached or the Stop button is pressed.



Manual Program Screen Step 2















1. Press the  button to go to the Manual program on the display. Press enter.
2. Set Workout time. Adjust the hour with the ▲/▼ buttons. Press the  button to move to minutes and adjust with the ▲/▼ buttons. Once the desired time is selected press enter.
3. Set Weight and Age. If weight and age are not already set, adjust weight with the ▲/▼ buttons. Press the  button to move to age use the ▲/▼ buttons to adjust. When finished press enter.
4. Press Start to begin workout.
5. The treadmill will start at 0.5 mph and 0 incline.
6. Adjust the speed and incline as needed.
7. Once your set time is reached, the manual program will end, and a summary view will pop-up.
8. You have the opportunity to sync data to go to the home screen.

Preset Programs

There are several programs available to help add structure and variety to your exercise program. These programs are grouped into 4 basic groups, Weight Loss, Sport Training, Healthy Living and Custom. All but the Custom Programs follow the steps below:



Preset Programs Screen Step 3

1. Press the  button until programs is highlighted and press enter.
2. Press  again until the desired program group is selected.
3. Use the / buttons to scroll to the desired program and press enter.
4. Press  to select speed or incline and press enter.
5. Set Program Level – There are 3 levels of intensity with each preset program (1 being the easiest and 3 being the most difficult). Press the  button until the desired intensity level is selected, then press enter.
6. Set Time – Set hours by pressing the / buttons. Press  to move to the next digits adjusting with the / buttons. When done press enter.
7. Set Weight and Age – Set your Weight for a more accurate calorie calculation. Also, set your age for heart rate calculations. Adjust your weight using  to move between digits, and the / buttons to make adjustments. Set age using the same method. When finished, press enter.
8. Press Start to begin workout.







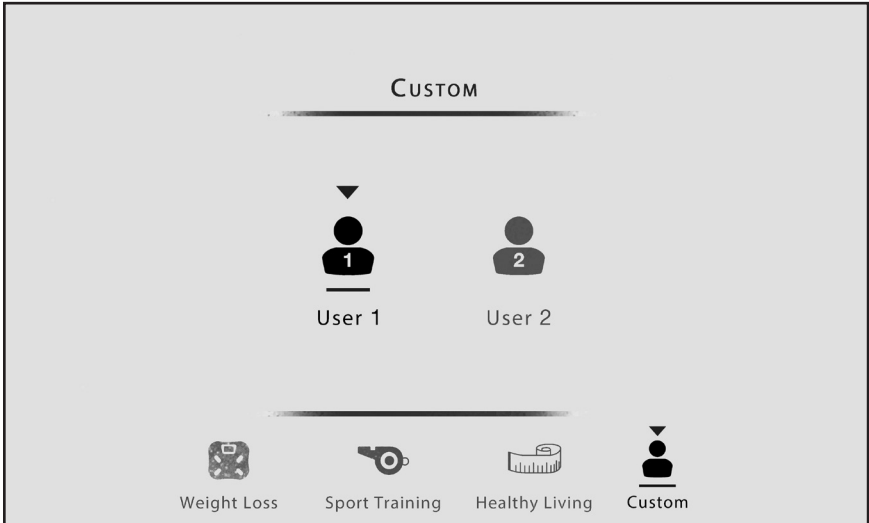



Operations

Custom User Set-up Programs

There are 2 user programs that provide you with the ability to establish customized program profiles specific to your workout requirements. Once these programs are completed they are saved by the console and can be selected like any other preset program. Complete the following steps to set up a user program:



Custom User Set-Up Program Screen Step 3

1. Select Programs from the touch screen by pressing  until programs is selected. Press enter.
2. Select the Custom program group from the bottom of the screen by pressing  until custom is selected. Press enter.
3. Select User 1 or User 2 by pressing the  buttons and press enter.
4. Set Time – Set hours by pressing the / buttons. Press  to move to the next digits adjusting with the / buttons. When done press enter.
5. Set Weight and Age – Set your weight for a more accurate calorie calculation. Also, set your age for heart rate calculations. Adjust your weight using  to move between digits, and the / buttons to make adjustments. Set age using the same method. When finished, press enter.

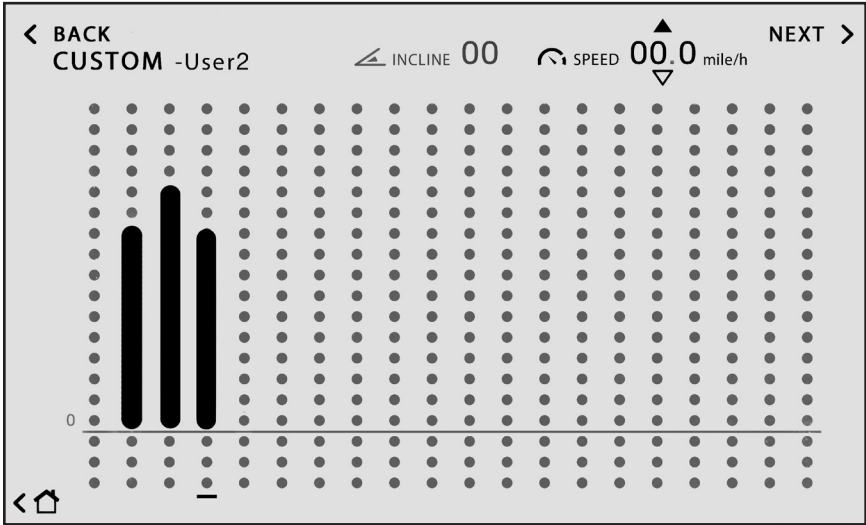

Programs Screen Step 6

6. Set the desired speed and incline for each of the 20 segments in the workout. Adjust the speed and incline for column 1 by using the ▲/▼ buttons. When done, press  to move to the next column. Once all columns are adjusted, press enter.
7. Press Start to begin workout.

Operations





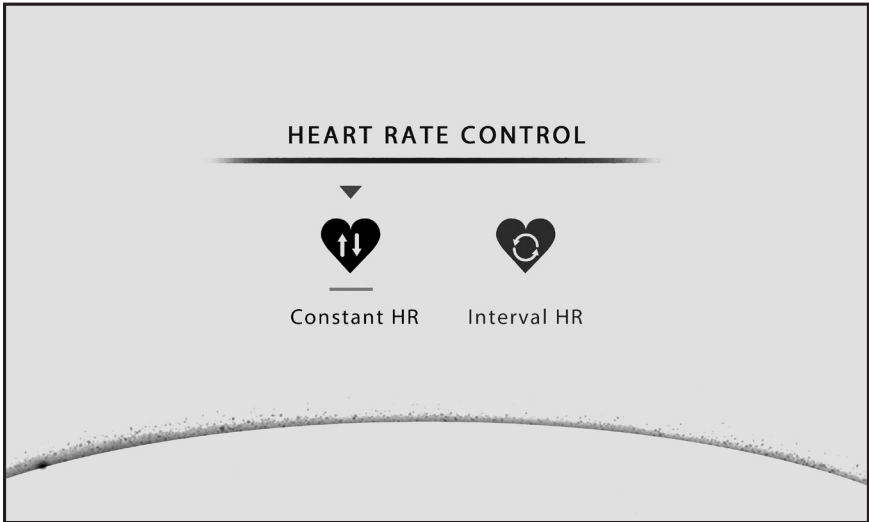



HRC – Constant

The Constant Heart Rate program lets you select a single heart rate that you want to maintain throughout your workout and the treadmill will maintain this heart rate for you by either adjusting the speed or incline.



Showing Screen for Step 2

To use this program:

1. Select HR Control from the Home Screen by pressing the  until highlighted. Press enter.
2. Select Constant HR by pressing  until Custom Heart Rate is selected. Press enter.
3. Press  to select speed or incline and press enter. The treadmill will adjust the speed or incline every 10 seconds to keep you at your selected heart rate level. For instance, if you select the incline mode, there will be a 3-minute warm-up and then the incline will start to adjust each 10 seconds to obtain and maintain your target heart rate. You choose the speed that you want the belt to run and the treadmill will control the incline.
4. Set Time – Set the amount of time that you would like to work out by pressing the / buttons. Press  to move to the next digits adjusting with the / buttons. When done press enter.



Showing Screen for Step 6

5. Set Weight and Age – Set your weight for a more accurate calorie calculation. Also, set your age for heart rate calculations. Adjust your weight using  to move between digits, and the ▲/▼ buttons to make adjustments. Set age using the same method. When finished, press enter.
6. Select your constant target heart rate by pressing the ▲/▼ buttons until the desired heart rate is selected. When done press enter.
7. Press Start to begin workout.

Operations

HRC – Interval

The Interval Heart Rate program is designed to help you increase anaerobic endurance and improve heart rate recovery. The program lets you select both a high target heart rate and a low recovery heart rate.

After a 3-minute warm-up, the console will adjust the incline or speed (your choice) every 10 seconds until you reach your high target heart rate. It will keep you there for 2 minutes. Then it will adjust incline or speed every 10 seconds to reduce your heart rate to your low recovery level, then keep you there for 2 minutes. This repeats until the end of your workout.

It is recommended that you set the workout time to 30 minutes or longer to use this program effectively.

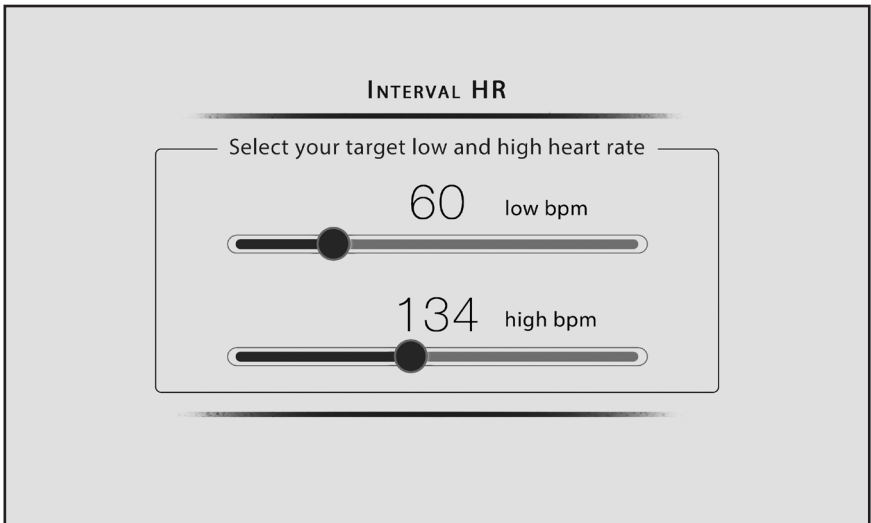

Showing Screen for Step 2

To use this program:

1. Select HR Control from the Home Screen.
2. Select Interval HR by pressing  and press enter.
3. Choose to have the program adjust speed or incline and press next. The treadmill will adjust the speed or incline every 10 seconds to keep you at your selected heart rate level. For instance, if you select the incline mode, there will be a 3-minute warm-up and then the incline will start to adjust each 10 seconds to obtain and maintain your target heart rate. You choose the speed

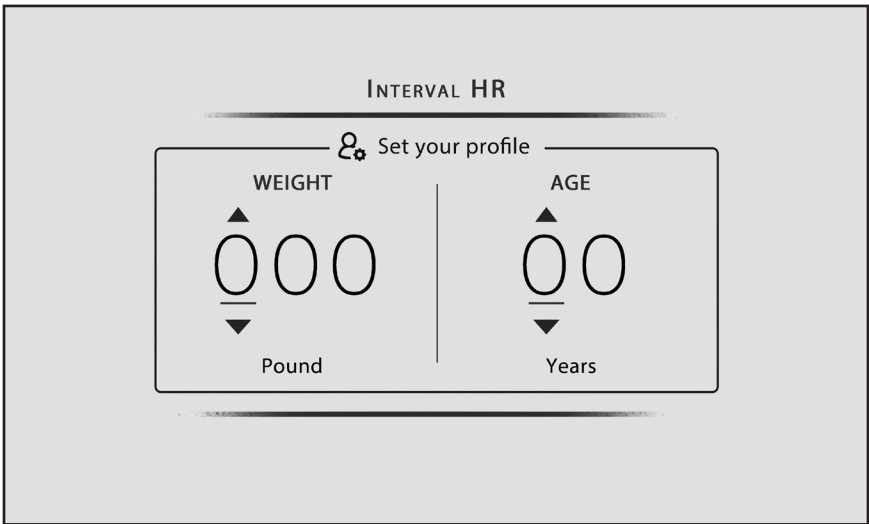

Showing Screen for Step 5

that you want the belt to run and the treadmill will control the incline.

4. Set Time – Set the amount of time that you would like to work out and press next.
5. Set Weight and Age – Set your weight for a more accurate calorie calculation. Also, set your age for heart rate calculations and press next.
6. Select your target low heart rate by pressing the ▲/▼ buttons. Press  to change to the High Heart Rate and use the ▲/▼ buttons to adjust. When the desired adjustments are complete, press enter.
7. Press Start to begin workout.

NOTE: Remember that the console needs to receive your heart rate through the grip pulse or a heart rate chest strap during the course of the workout.



WARNING: Heart rate monitoring may be inaccurate. Over exercising may result in serious injury or death. If you feel faint stop exercising immediately.

Operations

Summary

When your workout is finished, or stop is pressed twice, a Summary screen will be displayed.

SUMMARY			
A	Pace	02:03:40	F Max Heart Rate 160 bpm
B	Time	03:15:32	G Avg. Heart Rate 123 bpm
C	Calories	1,020 kcal	H % Max Heart Rate 76 %
D	Max Speed	13 kph	I Elevation +1,245 m
E	Distance	14.2 km	J Steps Count 12,050 steps

[SYNC DATA](#) 

Summary Screen

-
- A. **Pace** - The average number of minutes it took to complete a mile or kilometer.
 - B. **Time** – The total workout time.
 - C. **Calories** – Total calories burned.
 - D. **Max Speed** – The highest speed achieved during the workout.
 - E. **Distance** - The total distance traveled in during the workout in Miles or Kilometers.
 - F. **Max Heart Rate** - The highest heart rate reading during the workout.
 - G. **Avg. Heart Rate** - The average of heart rate readouts throughout the workout.
 - H. **% Max Heart Rate** - This is the percentage of your suggested max HR (220 - age).
 - I. **Elevation +** – The number of feet or meters climbed during the workout.
 - J. **Step Count** – The total number of steps taken during the workout.

Operations

Hand Pulse Sensors

To use, grasp the sensors with a comfortable grip, with the palms of your hands placed over the sensors. If the sensors are having difficulty picking up your heart rate, use aloe or a moisturizer on your hands or further warm up as you exercise to increase the moisture in your hands. Dry hands do not transfer your pulse as effectively as moist hands.

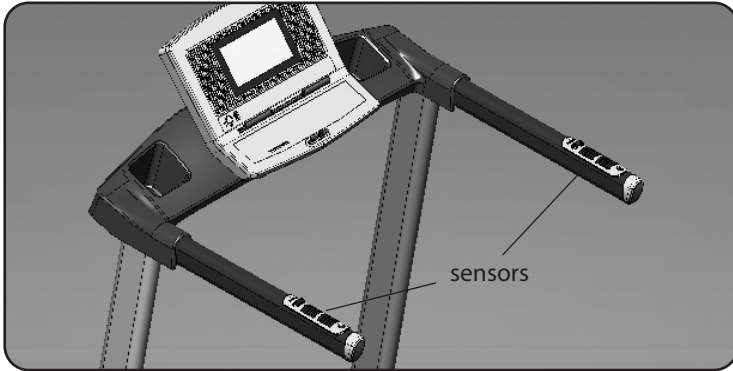

Chest Strap

The TR1200i has an integrated Bluetooth heart rate receiver built into the console. To purchase a heart rate chest strap, or arm band go to www.LifeSpanFitness.com.

The chest strap should be worn as shown. When using a chest strap you may need to warm-up first to increase the moisture in your skin. If this doesn't work, use aloe or another moisturizer where the sensors on the chest strap are making contact with your skin.

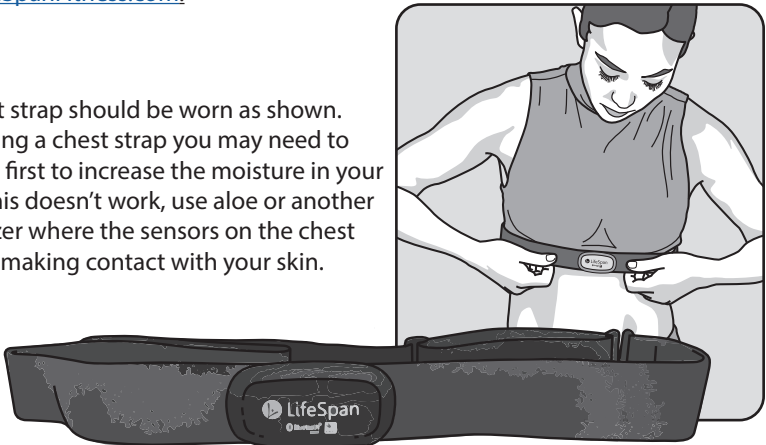

NOTE: The heart rate monitoring system will vary due to your age, method of use, physiology and other factors. LifeSpan cannot guarantee the accuracy of the heart rate readings.

Equipment Settings

The TR1200i comes with the ability for you to customize several console settings. To make these adjustments simply hold the stop button and the speed up button for 3 seconds simultaneously.

SETTING OPTIONS			
A Intelli-Guard	<input type="checkbox"/>	F Units	<u>English</u> Metric
B Audible Beep	<input type="checkbox"/>	G Pause Time (seconds)	90 180 <u>300</u> Off
C Resume Speed	<input type="checkbox"/>	H Energy Saving (minutes)	<u>10</u> 20 Off
D Warm up / Cool Down	<input type="checkbox"/>	I Total Hours	0000000
E Tutorial	<input type="checkbox"/>	J Total Distance	0000000
		Firmware Version	

Personal Settings Screen

- A. **Intelli-Guard™** - This feature is triggered when the treadmill senses you are no longer walking or running. For safety purposes it automatically pauses the belt to avoid accidental falls resulting in possible injury. There are several factors that affect the accuracy of this feature including your walking style, weight and usage characteristics. While we don't recommend it, this feature can be turned off if required.
- B. **Audible Beep** - Turns off the audible alert that beeps for speed and incline changes or when the treadmill is starting or stopping.



WARNING: The audible alert is turned on from the manufacturer to warn you that the treadmill is starting or the speed is changing. Turning this alert off is done at the sole discretion of you.

- C. **Resume Speed:** Turning resume speed on allows the treadmill to restart (after a pause) at the same speed it was going prior to pressing pause. When turned off, the speed resumes at the minimum speed, usually around 0.5 mph/0.8 kph.

Operations

- D. **Warm-up/Cool Down:** This feature automatically adds a 3-minute warm-up and 3-minute cool down to the Treadmill Preset Programs. It is turned on by default, but if the warm up/cool down feature is not desired, simply turn it off.
- E. **Tutorial** - Turns the operations tutorial on or off.
- F. **English or Metric** - Used for both speed and distance in miles or kilometers shown on the display.
- G. **Pause Time** - The number of seconds the treadmill will pause before going into Standby Mode or to the home screen. This feature can also be turned off entirely. If turned off, the treadmill will not go into energy saving mode while the treadmill is paused.
- H. **Energy Savings** - Turn Energy Saving On or Off. Energy saving mode will shut down most electronics on the treadmill, which in turn conserves energy.
- I. **Total Hours** - The total number of hours the treadmill has been run.
- J. **Total Distance** - The total number of miles/kilometers the treadmill has run.

Program Profiles

Remember, if you simply get on your treadmill and go at the same pace, for the same amount of time everyday your body will only improve to the level of the workouts you are pushing yourself to do. To help get the most out of your time spent exercising, LifeSpan treadmills include a full range of workout programs. All programs are available in either “Speed” or “Incline” mode with 3 levels of intensity that you select during program set-up. When the “Speed” mode is selected, the belt speed will vary during your workout while the incline level stays constant. In “Incline” mode the speed remains constant while the incline is adjusted by the program. In either mode you have full control of the setting that is not being controlled by the program.

To complement these preset programs, you can use either of the 2 types of heart rate training programs or design your own program.

The treadmill has a 3-minute warm-up and cool down to the preset programs. It starts at 3 mph (for warm-up) or 2.5 mph (for cool down), but you have full control over the speed. To skip warm-up, press Start. To skip cool down, press Stop. The distance, steps, time, and calories you accumulate in warm-up and cool down are not counted in your workout totals.

Preset Programs

Long Slow Distance-1

(40 minutes default)



Long slow distance is a great workout for anyone! Beginners can ease into their exercise program and should include a long slow distance workout each week to maximize overall cardiovascular endurance development. Long slow distance workouts are also great for experienced exercisers on days following a harder, higher intensity workout.

Short Interval

(20 minute default)



Short intervals are ideal for beginning exercisers that want to start gaining the benefits of interval workouts but aren't quite ready for a longer-intensity interval workout. Short intervals are also ideal for experienced exercisers to develop their speed and anaerobic fitness. Remember, it's important to vary exercise intensity and duration to maximize overall fitness development so be sure to include some interval workouts at least once a week.

Operations

Moderate Interval

(30 minute default)



As you begin to exercise on a regular basis and feel your fitness improving you will be ready to begin doing “Moderate Intensity Interval” workouts. Remember in this workout you alternate between an easy recovery interval and a higher intensity interval. You should feel comfortable to push yourself as you are never too far away from an easier recovery interval. This workout will improve your overall aerobic endurance while also maximizing anaerobic fitness development.

Long Interval

(40 minute default)



Long Interval workouts are great to maximize calorie burn and improve anaerobic fitness. As in the moderate interval workouts, remember you have a recovery period after each higher intensity interval so you can comfortably push yourself to exercise at a progressively higher level.

Negative Interval 1

(30 minute default)



The Negative Interval-1 workout provides the benefits of a steady pace workout but pushes you to slowly obtain a progressively higher steady state exercise intensity and then allows you to slowly decrease the exercise intensity. As your fitness level improves, you can slowly push yourself to a higher peak in overall exercise intensity.

Negative Interval 2

(30 minute default)



The Negative Interval-2 workout has been designed to provide your body with a workout that begins with a slight increase in exercise intensity and ends with a progressive decrease in intensity. A workout with an increase and decrease in intensity will most ideally develop your overall aerobic cardiovascular endurance. A workout that decreases in intensity is also ideal for maximizing calorie burn, but most ideally when done for a longer duration, such as 40 or 50 minutes.

Fartlek

(30 minute default)

Varying your exercise intensity with a constantly changing interval workout

that starts out at an easy pace and then increases to a moderate or higher intensity pace will add variety into your workouts, make workouts go by faster and provide great fitness benefits. Constantly varying intensities in a workout have been found in brain research to have great benefits on improving overall brain fitness.



Uphill Climb

(30 minute default)

Gradually increase the intensity of your exercise with this fun uphill

climb workout. The goal of the uphill climb is to stimulate your body to improve overall cardiovascular fitness while maximizing muscle cell development in working muscles. You will maximize calorie burn during the peak levels while allowing your body to exercise longer and still benefit from the higher intensity as you slow down and return to your starting level.



Pyramid Climb

(30 minute default)

Gradual increases in intensity is ideal to stimulate your body to improve

overall cardiovascular fitness, while also maximizing muscle cell development in working muscles. You will maximize overall calorie burn during the peak intensity levels while allowing your body to exercise for a longer duration and still benefit from the higher intensity as you gradually slowdown.



Plateau Climb

(40 minute default)

A plateau climb workout will provide you with all the benefits of other

steady state workouts, but push you to maintain a higher steady state exercise level. As you improve your overall health and fitness you can slowly push to a higher overall intensity for longer periods of time.



Operations

Ladder

(30 minute default)



One of the greatest benefits of exercise are the direct benefits

exercise has on the heart and cardiovascular system. The heart health ladder has been specifically designed to provide your heart and cardiovascular system with a series of progressively harder exercise intensity's that will improve your overall aerobic endurance, while also stimulating anaerobic endurance. Remember that it may be challenging for a few minutes, but each progression has been carefully designed to provide recovery intervals so you can push to improve your cardiovascular fitness.

Uphill Interval

(20 minute default)



Uphill Interval workouts are unique

in that they provide your body with the benefits of an interval workout, with the added benefits of gradually increasing the overall intensity. In this workout you should begin at a level that is comfortable and then increase the intensity during each maximum interval, pushing to a slightly higher intensity each time. You will get maximum overall calorie burn during of the higher intensity intervals, while at the same time working on improving your overall anaerobic fitness.

Steady Pace

(40 minute default)



Improve your fitness while also simulating your body to burn more fat with this workout. Steady pace workouts are great for helping you establish an improved overall endurance base. Most "Steady Pace" workouts focus on maintaining one set workload throughout the entire workout. Your goal is to be sure you are exercising within a low moderate intensity to a high moderate intensity during the workout.

Long Slow Distance 2

(40 minute default)



Compared to the long slow distance 1

program, this workout expedites the rate of increasing exertion, allowing for more workout time to be spent at higher levels of intensity.

Cardio Run

(20 minute default)



Cardio run is a steady pace workout

but at a higher intensity than "Long Slow Distance". Cardio run is a more advanced

workout, designed to motivate you to achieve a more challenging steady pace and maintain that pace for the full duration of the workout. Cardio Run is a great workout if you are training for a special event.

Short Interval 2

(20 minute default)

Short interval workouts have been found in research studies to be ideal for those striving to lose weight and improve cardiovascular fitness. Varying exercise intensity from a moderately slow level to a high intensity for a set period of time and repeating that progression for a complete workout will maximize the number of calories burned. The short interval recovery periods allows the body to more successfully exercise at a higher intensity than might otherwise be comfortable for a complete workout duration.



Uphill Walk

(30 minute default)

The uphill walk gradually increases the intensity of your exercise peaking at a high intensity. The goal of the uphill workout is to stimulate your body to improve overall cardiovascular fitness, while also maximizing muscle cell development. The uphill walk has been designed to start slow and gradually increase to a peak intensity then with a quick decrease back to a recovery level. You will maximize calorie burn during the peak intensity levels while allowing your body to exercise for longer periods.



Custom User Programs

There are two user programs that provide you with the ability to build custom program profiles for your specific workout requirements. In custom user programs you set the workout time and then for each of the 20 program segments you set the speed and incline. This program is different than our preset programs in that both speed and incline can be controlled simultaneously. As such, the program matrix display readout will show both incline and speed at the same time. The speed and incline are represented in different colors so they are easy to see.

Maintenance and Tips

Heart Rate Monitoring

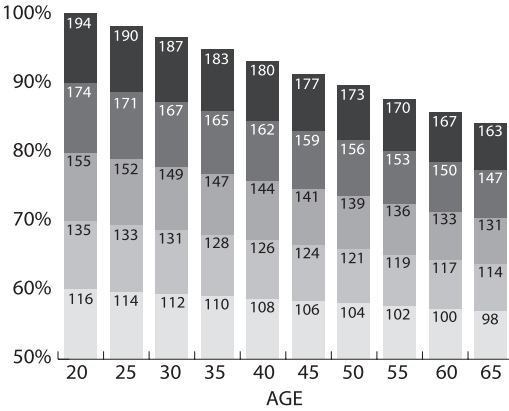

Seeing your heart rate while exercising will help you understand the intensity of your exercise and corresponding heart rate training zone, and predict health benefits found through repeated bouts of exercise. Refer to the information below to understand your heart rate training zones:

Zone 5 — Performance Redline Zone: 90% - 100% of your Max HR

The performance zone involves extreme effort, requiring the heart to beat at or near maximum capacity. Training bouts include intense incline or sprinting, benefiting speed, power, and anaerobic performance competency.

Zone 4 — Threshold Zone: 80% - 90% of your Max HR

The threshold zone involves intense jogging or sub-maximal sprinting, typically unsustainable for long periods of time. Benefits include highly-elevated calorie burn, speed and power performance enhancement, improved lactate removal capabilities, and enriched heart health.

Zone 3 — Aerobic Zone: 70% - 80% of your Max HR

The aerobic zone is ideal for cardiovascular training. Workouts in this zone are more intense, involving moderate jogging. Long-term benefits are improved heart health and cardiovascular performance, reductions in blood pressure and cholesterol, and increased calorie burn.

Zone 2 — Temperate Zone: 60% - 70% of your Max HR

The temperate zone consists of moderate-intensity exercise, typically as fast walking to slow jogging. Speaking is more difficult and breathing is elevated. Benefits are similar to those of the healthy heart rate zone, though caloric expenditure is higher.

Zone 1 — Healthy Heart Zone: 50% - 60% of your Max HR

The healthy heart zone involves safe, low-intensity activity, like medium-to-brisk walking. Full conversations can be held, despite a gentle increase in respiration. Benefits include reduced risk of heart and vascular disease, moderated blood pressure and cholesterol, and improved insulin sensitivity.

Cleaning

Daily

It is recommended to wipe the treadmill down after each use to keep the treadmill clean and dry. A mild detergent may be used at times to help remove all dirt and salt from the belt, painted parts and the display.

Monthly

This cleaning would include removing the motor cover and cleaning around the motor and electronics. It is recommended to clean the motor compartment if the treadmill is in an area where there might be plush carpet fibers that could get pulled up into the motor compartment. It is a good idea at this time to check and tighten all assembly hardware, power cord for damage, or anything else that would indicate the need for service.

Safety and Integrity

The safety and integrity designed into the machine can only be maintained when the treadmill is regularly examined for damage and repaired. Worn or damaged components should be replaced immediately or the treadmill be removed from service until the repair is made. Pay special attention to components most susceptible to wear.



WARNING: Keep the treadmill stable on flat ground. Over-exercising or inadequate training may result in physical injury.



WARNING: Unplug the power cord before removing the motor cover.



IMPORTANT: If service is required, turn the power off and remove the power cord to ensure the unit cannot be used. Let all other users know the unit needs service.



CAUTION: Acidic cleaning detergents may damage painted or powder coated surfaces and should not be used. Such cleaners may void the LifeSpan warranty.

Maintenance and Tips

Belt Lubrication

Use only 100% silicone and avoid using aerosol silicone sprays which include additives and petroleum distillates. One ounce of silicone should be used for each application. LifeSpan offers 100% silicone lubricant that can be ordered at www.LifeSpanFitness.com.

The running belt comes pre-lubricated from the factory and should be lubricated every 3 months (regardless of use) or 50 hours of use, whichever comes first. Even if the treadmill is not being used, the silicone will dissipate over time and the belt will dry out.

Apply the silicone to the underside of the treadmill belt. Do not apply to the walking surface. This may be accomplished by folding the treadmill up and applying the silicone to the inside portion of the running belt or by leaving the treadmill in the normal use position and simply lifting the belt up over the side rails and applying the lubricant under the running belt onto the deck surface. The silicone will absorb into the underside of the belt as you start walking.

NOTE: When lubricating the belt, make sure the treadmill is on a surface that can be easily cleaned. After lubricating your treadmill running belt, clean any excess silicone off the walking surface of the belt and side rails.

Folding the Treadmill

- A. Make sure that the On/Off switch is turned Off and the power cord is removed from the wall.
- B. Make sure nothing is on or near your treadmill which might spill, be knocked over or prevent the treadmill from completely folding.
- C. Place both hands under the support bar that is located directly under the back of the running belt on your treadmill to make sure that you have a solid lifting point.
- D. Lift the treadmill all the way forward and make sure the hydraulic shock is properly locked in place.

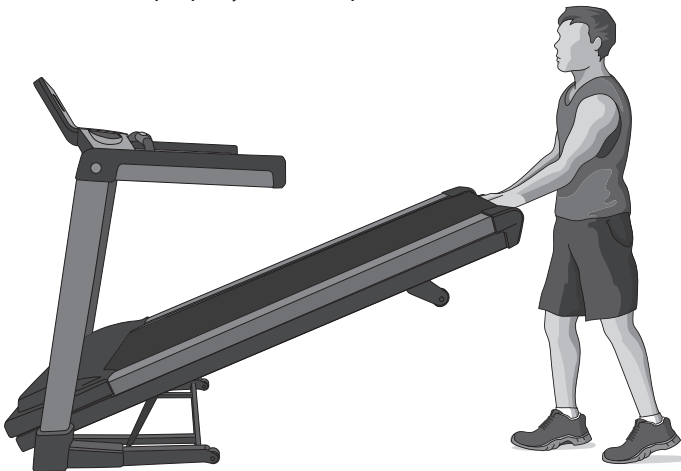

- E. Ensure that the locking mechanism is secure by gently pulling back on the treadmill and make sure that it doesn't move.



CAUTION:

- Use proper safety precautions and lifting techniques. Bend your knees and elbows, keep your back straight and pull up with both arms.
- Do not fold the treadmill by lifting on the running belt or rear roller.
- Do not lean against the treadmill once it is folded or place items on it that could cause it to become unstable or fall over.
- Do not connect the power cord when the treadmill is folded or try to operate the treadmill in the folded position.

Maintenance and Tips

Unfolding the Treadmill

- A. Make sure you have adequate space to lay the treadmill down. There needs to be at least 2 feet of clearance on both sides and in the front of the treadmill. There should be at least 4 feet of clearance on the back side of the treadmill for safety reasons. If you were to fall this would give adequate clearance to get off the treadmill.
- B. Inspect so nothing is on or near your treadmill that might spill, be knocked over or prevent the treadmill from completely unfolding.
- C. Position yourself behind the treadmill. Slightly push the treadmill forward towards the display and with your foot pull up on the hydraulic shock lever. The treadmill can now be pulled back away from the console. (See FIG. 1, 2 & 3)
- D. The hydraulic shock is set up to drop softly without assistance. It is not a bad idea to hold onto the treadmill until it is about 2/3 of the way down. Make sure that you use proper lifting technique, bending your knees and keeping your back straight.

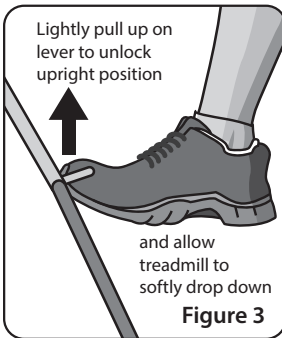
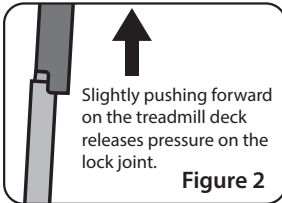
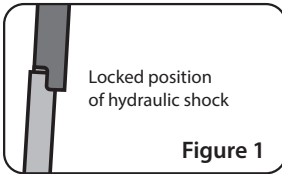

Moving the Treadmill

- A. Make sure the ON/OFF switch is turned OFF and the power cord is removed from the wall.
- B. Make sure nothing is on or near your treadmill which might spill, be knocked off, or prevent the treadmill from moving.
- C. Place both hands under the support bar located under the back of the running belt to make sure you have a solid lifting point.
- D. Lift the back of the treadmill and roll to the desired location.

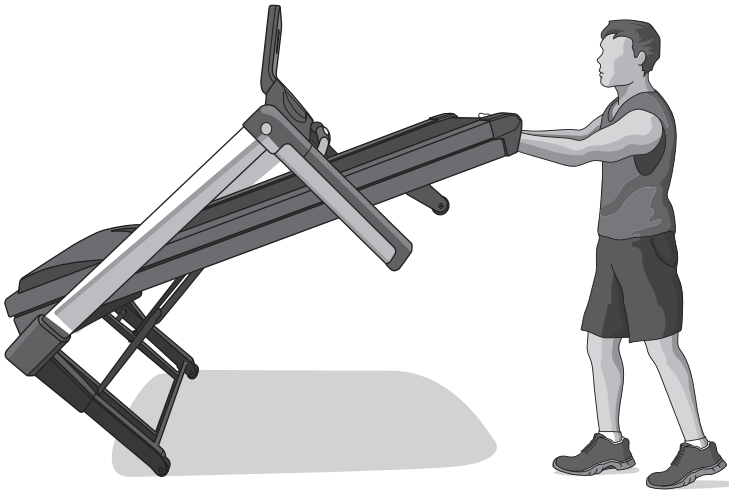

CAUTION: When lifting, use proper safety precautions and lifting techniques. Bend your knees and elbows, keep your back straight and pull up evenly with both arms.

Belt Tensioning

If the belt begins to slip and needs to be tensioned, there are tension bolts that are accessible from the back of the treadmill. Before tensioning the belt, start the treadmill and set the speed to 3 mph (5 kph).

- A. Using a 6 mm Allen wrench, included in your hardware bag, turn the right and left tension bolts 1/2 turn clockwise. See figures on next page.
- B. Test to see if the slipping is eliminated. If the belt slips repeat Step A and test again.

Maintenance and Tips

NOTE: Adjusting one side more than the other will cause the belt to drift to the side of the treadmill and will require belt alignment. Check to be sure the running belt is still aligned. If belt alignment is off as shown below refer to Belt Alignment section.

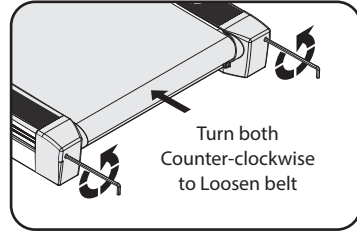
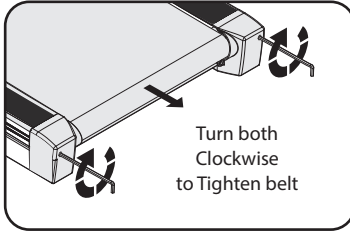

CAUTION: DO NOT tighten more than 2 full turns on each side. Over tensioning the belt can cause unnecessary friction and wear and tear on the belt, motor and electronics.

Belt Alignment

- Press Start, then increase the treadmill speed to 3 mph (5 kph).
- Stand at the rear of the treadmill to see which way the belt is drifting.
- If the belt drifts to the left, turn the left adjustment bolt one-quarter turn clockwise and the right adjustment bolt one-quarter turn counter-clockwise. (See FIG. 1)
- If the belt drifts to the right, turn the left adjustment bolt one-quarter turn counter-clockwise and the right adjustment bolt one-quarter turn clockwise. (See FIG. 2)
- Observe the tracking for two minutes. Repeat steps A-D as needed.

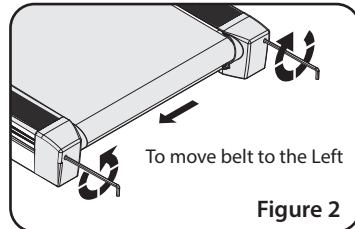
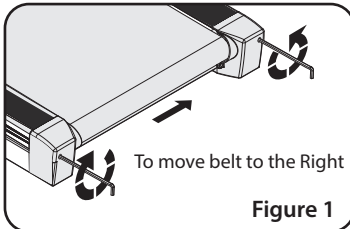

Visit www.LifeSpanFitness.com/support and click on FAQ to watch the full video demonstration on aligning your treadmill belt.

Troubleshooting

If you have a question that isn't answered in this Owner's Manual, call us at 801-973-9993 x4, or go to www.lifespanfitness.com/support and click on customer service to create a service request.

The treadmill is designed and manufactured to be reliable and easy-to-use. However, if you have a problem, these troubleshooting steps may help you find the cause.

Problem: The console does not turn on or function correctly.

Solution: Check to make sure the treadmill is properly plugged in, turn the power switch located by the power cord off and back on again and make sure the safety key is in place. Check all wire harness connections made during assembly to be sure they are all properly connected. If the problem persists contact LifeSpan Customer Service at www.LifeSpanFitness.com or call 801-973-9993x4.

Problem: The power button on the console does not turn the console on.

Solution: Check the main power switch and power cord located at the front of the treadmill on the right side. Make sure the power cord is plugged in and the power switch is turned on.

Problem: The belt does not stay in the center of the treadmill when in use.

Solution: First check to make sure that the treadmill is level, then refer to the instructions in this Owner's Manual on how to align the belt.

Problem: The treadmill belt slips during use.

Solution: The belt may need to be tensioned after a period of use. Refer to the Belt Tensioning Section of this Owner's Manual.

Problem: Heart rate is erratic or not reading.

Solution: Make sure your hands are moist (aloe vera helps). Make sure all connectors made during assembly, at the back of the console, are properly connected and no wires are damaged. If wearing a chest strap, be sure the batteries are good and that the electrodes are moist and positioned properly on your chest. You may need to pair the Bluetooth HR chest strap or arm band with the console.

Maintenance and Tips

***Problem:* Treadmill automatically pauses during workout.**

Solution: The treadmill is not detecting your steps because you have stopped walking or because your weight is too low to detect the steps, especially at an incline. One option would be to go to personal settings and turn Intelli-Guard off.

***Problem:* E1 Error Code after 3 to 8 seconds.**

Solution: This is most likely a bad wire connection or a speed sensor issue. Check all wire connections made during assembly and if this does not resolve the issue contact LifeSpan Customer Service at www.LifeSpanFitness.com or call 801-973-9993x4.

***Problem:* E1 Error Code after several minutes of use.**

Solution: This problem usually occurs when there is too much friction building between the running belt and deck. The best thing to do is turn the treadmill off, lubricate the running belt and turn the treadmill back on. Test the unit. If E1 still comes up after testing, contact LifeSpan Customer Service at www.LifeSpanFitness.com or call 801-973-9993x4.

***Problem:* E6 Error Code.**

Solution: Turn the power off for 30 seconds and back on again. Check to see if the incline is functioning. If still an issue, please check all wire connections made during assembly and cycle the power again. If still not functioning contact LifeSpan Customer Service at www.LifeSpanFitness.com or call 801-973-9993x4.

Unique Features

As a leader in the fitness industry, LifeSpan has developed a number of unique features in our treadmills making them more engaging, safer and easier to use. Learn more about how to use these features in Saving Your Results and Personal Settings sections of this Owner's Manual.



Intelli-Guard™

Walk confidently knowing your safety is assured with Intelli-Guard™. Step away from your treadmill for more than twenty seconds and your treadmill's belt will automatically glide to a smooth stop.



Intelli-Step™

Never miss a stride with Intelli-Step™. Your steps are automatically calculated with meticulous precision, displaying immediate feedback.



USB Charging Port

Charges most of your mobile devices. 5V, 0.5A Power Output. This port is also used to update Firmware.

About Your Treadmill

Specifications

TR1200i

Drive Motor	2.5 HP Continuous Duty
Max User Weight	300 lb (136 kg)
Heart Rate	Contact Sensors / Bluetooth Chest Strap & Arm Compatible
Speed Range	0.5 - 11 mph (0.8 - 18 kph)
Running Belt Size	20" x 56" (51 cm x 142 cm)
Incline Levels	0 to 15
Display Readouts	Program Profile, Time, Calories, Step Count, Distance, Heart Rate, Speed, Incline, Lap, Lap Time, % Max HR, Steps/Min, Cal/Hr, Splits, Pace and Elevation Change
Programs	Speed or Incline control for Weight Management, Healthy Living, Sports Training and Heart Rate Control as well as 2 customer user programs.
Deck Suspension	8-Independent Shock Absorbers
Roller Size	2.5" (64 mm) front / 2" (51 mm) back

Warranty

Your LifeSpan treadmill/bike desk comes with the following limited warranty valid in North America. If you are outside of this area contact your local authorized LifeSpan dealer.

Treadmill Frame	10 Years
Parts	2 Years
Labor	1 Year

LifeSpan warrants that the equipment it manufactures is free from defects in materials and workmanship under normal use and services. The periods above are based on the date of purchase. During these periods, LifeSpan will repair or replace any defective part. Free labor is included on all parts that are not normally assembled or replaced by the customer within the labor period.

If within the time frames specified above, any part fails to operate properly, login to our website at www.LifeSpanFitness.com, click on "Customer Service" and complete the form to request assistance or call 801-973-9993 x4 for a Customer Service Agent (please note that certain kinds of service should only be performed by a qualified service technician).

LifeSpan reserves the right to make changes and improvements to our products without incurring any obligations to similarly alter any product purchased. In order to insure our product warranty and to ensure the safe and efficient operation of your LifeSpan product, only authorized parts can be used. The warranty is void if any parts other than those provided by LifeSpan are used.

Exclusions and Limitations:

This warranty does not apply to any defects caused by negligence, misuse, improper assembly, or maintenance, accident, or "act of God."

This warranty does not apply to discoloration of paints or plastics.

LifeSpan shall not be responsible for incidental or consequential damages.

This warranty is non-transferable from the original owner.

TR1200i Color
Folding Treadmill

LifeSpan Fitness

*785 West 1700 South Suite 1
Salt Lake City, UT. 84104
Phone: 801-973-9993
www.LifeSpanFitness.com*

Version 2.0NB