

BALDWIN®



RESERVE™

TECHNICAL SPECIFICATIONS & PRICE LIST
NOVEMBER 2022

BALDWIN®

The style. The quality. The luxury. Baldwin is the trusted hardware leader with a 75-year reputation for bold design, crafted styling, and cutting-edge innovation that creates a sense of distinction in your home. Baldwin. A Reflection of You.

a Reflection of you

ESTATE™

crafted
FOR DISTINCTION

Baldwin Estate is the ultimate in style, quality, customization, and luxury for personalized design that is timeless



RESERVE™

instant style
& CUSTOMIZATION

Baldwin Reserve brings you the best of all worlds, style, customization, DIY, fast delivery, and Baldwin quality.



PRESTIGE SERIES

effortless
STYLE & QUALITY

Baldwin Prestige Series is for the distinctive DIYer. Prestige Series is easy to install, offers a choice of styles and finishes and has a great warranty.



WHAT'S NEW IN 2022



La Jolla Handleset in new
044 Satin Brass PVD Finish

Contemporary Knob with Contemporary
Square Rose in 044 Satin Brass PVD Finish

Baldwin is introducing our exclusive Lifetime PVD Finishes into the Reserve collection with the addition of bold, elegant Satin Brass. Meticulously constructed of the finest materials and combining stylish design with long-lasting quality, the Satin Brass PVD Finish (Physical Vapor Deposition) creates a subtle, smooth matte finish that complements any room. The specially treated surface is resistant to weathering, deterioration, harsh UV rays, and damage produced by salt-air, making it an ideal choice for both coastal homes and areas with inclement weather. Additional PVD finishes now offered in Reserve are Polished Brass 003 and Polished Nickel 055. There is no upcharge or extended lead times for Reserve PVD finishes.

Baldwin Hardware is proud to introduce our newest products to join the Reserve collection: The Contemporary 5" Rose and Contemporary Crystal Knob. Designed with an eye to modern, timeless design, our contemporary five-inch rose is universal, bold, and elevates any door it adorns.

Our Contemporary Crystal Knob is clean, elegant, and minimalist. An updated take on the traditional crystal knob, this contemporary design is a breathtaking statement piece. This design will launch in Fall 2022.



Contemporary Crystal Knob in Satin Black Finish

finishes

With a wide spectrum of richly detailed, designer finishes and textures, Baldwin stands alone as the finish leader. Baldwin finishes are meticulously crafted of the finest materials offered in a broad array of Lifetime and Lacquered finishes.

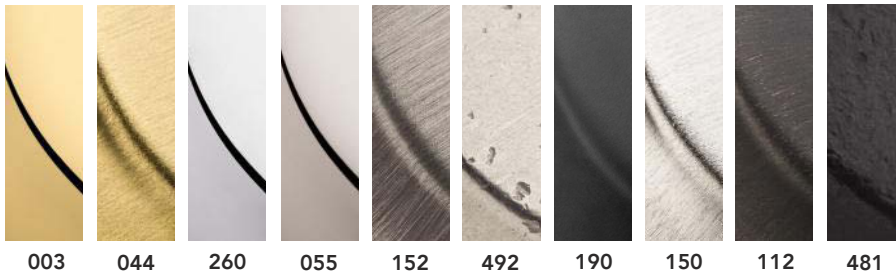

003 - Lifetime (PVD) Polished Brass

044 - Lifetime (PVD) Satin Brass

260 - Polished Chrome

055 - Lifetime (PVD) Polished Nickel

152* - Matte Antique Nickel

492 - White Bronze

190 - Satin Black

150* - Satin Nickel

112* - Venetian Bronze

481* - Dark Bronze

** HAND-RELIEVED FINISH VARIANCES: (112, 150, 152, 481)*

Product finishes which are HAND RELIEVED may vary in luster, hue and appearance as a result of handcrafted variances in the final finishing step.

BALDWIN RESERVE OFFERS TEN HAND-CRAFTED FINISHES TO CUSTOMIZE THE LOOK OF YOUR HARDWARE

Backed by an industry leading limited 25-year finish warranty on all lock products.

Matte versions of popular Baldwin Estate™ finishes including Matte Antique Nickel (152) and Satin Black (190).

Two Baldwin finishes, exclusively developed for Reserve; Dark Bronze (481) and White Bronze (492). These finishes replicate a sand cast look but are manufactured with a durable lacquer finishing process.

WARRANTY

LIMITED LIFETIME MECHANICAL WARRANTY

Except as limited below, Baldwin Hardware warrants to the original residential purchaser that each Baldwin Reserve locks product shall be free of mechanical defect for as long as the Purchaser occupies the residential premises upon which the product was originally installed.

LIMITED LIFETIME FINISH™ WARRANTY

The Baldwin Lifetime Finish uses advanced finishing PVD technology (physical vapor deposition) to create a finish highly resistant to the effects of weather and normal wear and tear. The Limited Lifetime Finish Warranty on Lifetime Finish™ products covers the original purchaser for as long as you own your home.

LIMITED 25-YEAR FINISH WARRANTY

Limited Finish Warranty: The finish on Baldwin Reserve lock products (excluding Lifetime PVD finish products) is protected by a durable topcoat designed to maintain the beauty and quality of the Baldwin product. Except as limited below, Baldwin Hardware warrants to the Purchaser that the finish on each Baldwin Reserve locks product shall not corrode, tarnish or discolor for 25 years from the original date of purchase.

This warranty DOES NOT COVER scratches; abrasions; or deterioration due to the use of paints, solvents, or other chemicals; abuse; damage from improper installation, misuse; product(s) used in commercial applications and/or any labor required to remove or replace the product under warranty. The warranty is limited to Purchasers who occupy the residential premises upon which the product was originally installed. Proof of purchase required. Refer to www.baldwinhardware.com for a complete warranty statement.

TABLE OF CONTENTS

OVERVIEW

Baldwin	2
What's New	3
Finishes	4
Warranty	5
Table of Contents	6
Reserve	7

PRODUCT OVERVIEW

Traditional	9
Contemporary	10
Rustic	11

HOW TO ORDER

Handlesets	12-13
Deadbolts	12-13
Knobs	12-13
Levers	12-13
Multipoint	29

PRODUCT CATALOG

Handlesets	14-19
Deadbolts	20-21
Knobs	22-23
Levers	24-26
Multipoint	27-28
General Hardware	30-34
Hinges	35

PRODUCT DETAILS

Functions & Handing	36
Door Thickness	36
Latches & Fronts	37
Strikes	37
Cylinders	38
Keying	38
Dimensions & Specs	39-44

SERVICE PARTS

Multipoint	45
Keys & Cylinders	46-47
Latches & Fronts	48
Strikes & Screwpacks	49
Misc. Parts	50
Thick Door Kits	51
Deadbolt Interior	51

ORDER SUBMISSION

Terms & Conditions	54
Baldwin Portfolio Comparison	55
Style & Finish Codes	56
Ordering with Additional Options	57



RESERVE™

The Reserve portfolio is for people who want more. They're looking for more ways to express themselves with the distinctive look of Baldwin and find value in a company with more years of experience and a bona fide commitment to quality. Far beyond just a "lock-in-a-box," Reserve opens the door to a customizable world flowing with inspiration. And it's all ready to go whenever inspiration strikes because with free shipping on all orders, your lock products are ready to ship in just 5 business days anywhere in the continental United States. Reserve is the best of both worlds: accessibility and artful appeal. Leave a lasting impression with Baldwin Reserve.





Del Mar Handleset in Satin Black Finish



Chesapeake (CHE)



Columbus (COL)



Napa (NAP)



Westcliff (WES)



Del Mar Egress (DEL)



Elizabeth Egress (ELI)



New Hampshire Egress (NEW)



Crystal (CRY)
Shown with Traditional Arched Rose



Ellipse (ELL)
Shown with Traditional Round Rose



Round (ROU)
Shown with Traditional Square Rose



Traditional (TRA)
Shown with Traditional Arch Rose



Traditional Round Deadbolt (TRD)



Traditional Square Deadbolt (TSD)



Traditional Arch Deadbolt (TAD)



Curve (CUR)
Shown with Traditional Round Rose



Decorative (DEC)
Shown with Traditional Arch Rose



Federal (FED)
Shown with Traditional Square Rose



Square Bevel (SBE)
Egress Trim



Elizabeth Arch (EBE)
Egress Trim



Traditional Arch (TAE)
Egress Trim



Chesapeake Multipoint



Del Mar Multipoint



Rectangular Bell Button



Oval Bell Button



Arch Bell Button

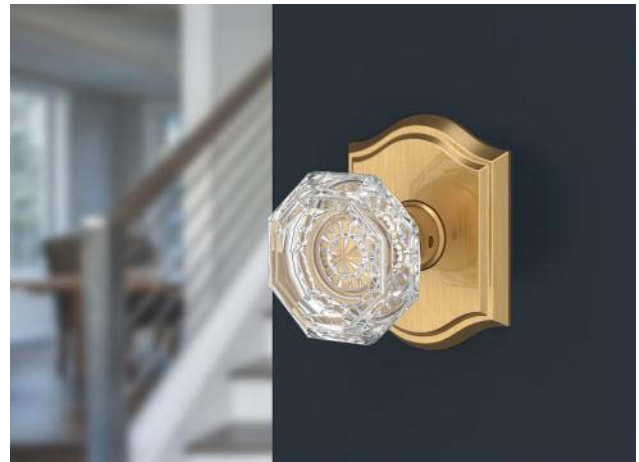

Crystal Knob with Traditional Arch Rose in Satin Brass Finish

TRADITIONAL FINISHES AVAILABLE



003 Lifetime (PVD) Polished Brass

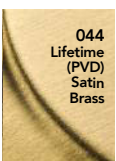

044 Lifetime (PVD) Satin Brass



260 Polished Chrome



055 Lifetime (PVD) Polished Nickel



150 Satin Nickel



152 Matte Antique Nickel

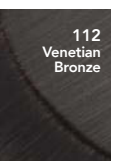

112 Venetian Bronze

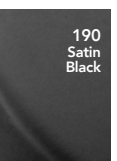

190 Satin Black

CONTEMPORARY



La Jolla
(LAJ)



Miami Egress
(MIA)



Seattle Egress
(SEA)



Santa Cruz Egress
(SAN)



Contemporary Square (CQE)
Egress Trim



Contemporary Round
Deadbolt (CRD)



Contemporary Square
Deadbolt (CSD)



Contemporary (CON)
Shown with Contemporary
Square Rose



Tube (TUB)
Shown with
Contemporary
Round Rose



Square (SQU)
Shown with
Contemporary
Square Rose



Contemporary Crystal (CCY)
Shown with Contemporary
Five Inch Rose



Contemporary Tube Lever with Contemporary 5" Rose in Satin Brass Finish



Seattle
Multipoint



Rectangular
Bell Button



Contemporary
Bell Button

CONTEMPORARY FINISHES AVAILABLE

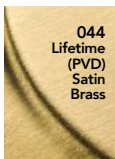

044
Lifetime
(PVD)
Satin
Brass



260
Polished
Chrome



055
Lifetime
(PVD)
Polished
Nickel



150
Satin
Nickel

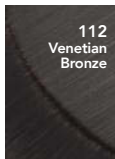

112
Venetian
Bronze



190
Satin
Black



Adirondack (ADI)



Elkhorn Egress (ELK)



Kodiak Egress (KOD)



Longview Egress (LON)



Rustic Arch (RAE)
Egress Trim



Square Bevel (SBE)
Egress Trim



Rustic Arch Deadbolt (RAD)



Rustic Square Deadbolt (RSD)



Taper (TAP)
Shown with Rustic
Square Rose



Arch (ARC)
Shown with Rustic
Arch Rose



Rustic (RUS)
Shown with Rustic
Square Rose



Elkhorn
Multipoint



Longview
Multipoint

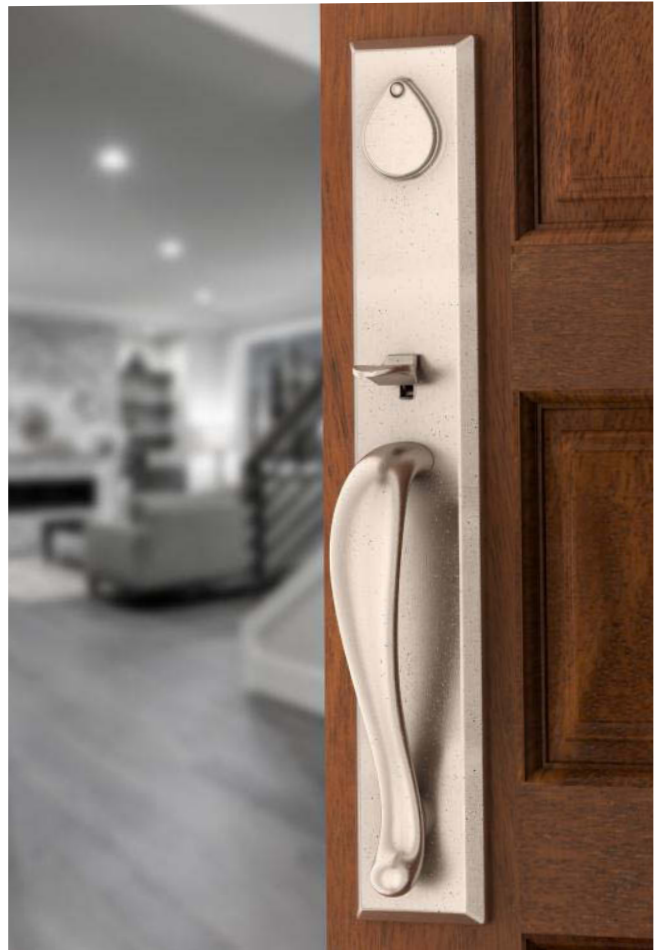

Longview Egress in White Bronze Finish



Arch
Bell Button

RUSTIC FINISHES AVAILABLE

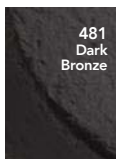

HOW TO ORDER

HANDLESETS

1. Required – Start your order configuration with the following required information:

Example: "I would like two Double Cylinder SmartKey-Columbus handlesets keyed alike in venetian bronze finish with the traditional arch rose and decorative lever in satin nickel on the interior. The door is right hand and my door is currently prepared for round corner latches and strikes."

DC		COLXDEC				R		TAR		112x150		
Function		Style Exterior X Interior				Handing		Rose / Interior Escutcheon		Finish Exterior x Interior		
SC	Single Cylinder	ADI	Adirondack	CON	Contemporary	L	Left	TRR	Trad. Round Rose	Traditional Styles		
DC	Double Cylinder	CHE	Chesapeake	ELL	Ellipse	R	Right	TAR	Trad. Arch Rose	003	Polished Brass PVD	
FD	Full Dummy	COL	Columbus	ROU	Round			TSR	Trad. Square Rose	044	Satin Brass PVD	
		LAJ	La Jolla	RUS	Rustic			CFR	Cont. Five In. Rose	112	Venetian Bronze	
		NAP	Napa	TRA	Traditional			CRR	Cont. Round Rose	150	Satin Nickel	
		WES	Westcliff	ARC	Arch			CSR	Cont. Square Rose	152	Matte Antique Nickel	
				CUR	Curve			RAR	Rustic Arch Rose	260	Polished Chrome	
				DEC	Decorative			RSR	Rustic Square Rose	055	Polished Nickel PVD	
				FED	Federal					190	Satin Black	
				SQU	Square						Contemporary Styles	
				TAP	Taper						112	Venetian Bronze
				TUB	Tube						044	Satin Brass PVD
											150	Satin Nickel
											260	Polished Chrome
											055	Polished Nickel PVD
											190	Satin Black
												Rustic Styles
											481	Dark Bronze
											492	White Bronze

DEADBOLTS

1. Required – Start your order configuration with the following required information:

Example: "I would like a single cylinder traditional round deadbolt in satin nickel finish, but I prefer the traditional arch turnpiece instead. The turnpiece should be brass color."

SC		TRDXTAD				150x003	
Function		Style Exterior X Interior				Finish Exterior x Interior	
SC	Single Cylinder	TRD	Traditional Round Deadbolt			Traditional Styles	
DC	Double Cylinder	TAD	Traditional Arch Deadbolt			003	Polished Brass PVD
PT	Patio	TSD	Traditional Square Deadbolt			044	Satin Brass PVD
		CRD	Contemporary Round Deadbolt			112	Venetian Bronze
		CSD	Contemporary Square Deadbolt			150	Satin Nickel
		RAD	Rustic Arch Deadbolt			152	Matte Antique Nickel
		RSD	Rustic Square Deadbolt			260	Polished Chrome
						055	Polished Nickel PVD
						190	Satin Black
							Contemporary Styles
						112	Venetian Bronze
						044	Satin Brass PVD
						150	Satin Nickel
						260	Polished Chrome
						055	Polished Nickel PVD
						190	Satin Black
							Rustic Styles
						481	Dark Bronze
						492	White Bronze

KNOBS

1. Required – Start your order configuration with the following required information:

Example: "I am looking for the traditional knob with the traditional round rose outside and traditional arch rose inside. I need two privacy knobs. They should all be in satin nickel finish."

PV		TRA				N/A		TRRXSTAR		150		
Function		Style Exterior X Interior				Handing		Rose Exterior X Interior		Finish Exterior x Interior		
EN	Entry	CCY	Cont. Crystal	ARC	Arch	L	Left	TRR	Trad. Round Rose	Traditional Styles		
PS	Passage	CON	Contemporary	CCY	Cont. Crystal	R	Right	TAR	Trad. Arch Rose	003	Polished Brass PVD	
PV	Privacy	CRY	Crystal	CON	Contemporary			TSR	Trad. Square Rose	044	Satin Brass PVD	
FD	Full Dummy	ELL	Ellipse	CRY	Crystal			CFR	Cont. Five In. Rose	112	Venetian Bronze	
HD	Half Dummy	ROU	Round	CUR	Curve			CRR	Cont. Round Rose	150	Satin Nickel	
		RUS	Rustic	DEC	Decorative			CSR	Cont. Square Rose	152	Matte Antique Nickel	
		TRA	Traditional	ELL	Ellipse			RAR	Rustic Arch Rose	260	Polished Chrome	
				FED	Federal			RSR	Rustic Square Rose	055	Polished Nickel PVD	
				ROU	Round					190	Satin Black	
				RUS	Rustic						Contemporary Styles	
				SQU	Square						112	Venetian Bronze
				TAP	Taper						044	Satin Brass PVD
				TRA	Traditional						150	Satin Nickel
				TUB	Tube						260	Polished Chrome
											055	Polished Nickel PVD
											190	Satin Black
												Rustic Styles
											481	Dark Bronze
											492	White Bronze

LEVERS

1. Required – Start your order configuration with the following required information:

Example: "I would like an entry tube lever with contemporary round rose with 150 exterior and 260 interior. The door is right hand and currently prepared for round corner latches and strikes."

EN		TUB				R		CRR		150x260		
Function		Style Exterior X Interior				Handing		Rose Exterior X Interior		Finish Exterior x Interior		
EN	Entry	ARC	Arch	ARC	Arch	L	Left	TRR	Trad. Round Rose	Traditional Styles		
PS	Passage	CUR	Curve	CCY	Cont. Crystal	R	Right	TAR	Trad. Arch Rose	003	Polished Brass PVD	
PV	Privacy	DEC	Decorative	CON	Contemporary			TSR	Trad. Square Rose	044	Satin Brass PVD	
FD	Full Dummy	FED	Federal	CRY	Crystal			CFR	Cont. Five In. Rose	112	Venetian Bronze	
HD	Half Dummy	SQU	Square	CUR	Curve			CRR	Cont. Round Rose	150	Satin Nickel	
		TAP	Taper	DEC	Decorative			CSR	Cont. Square Rose	152	Matte Antique Nickel	
		TUB	Tube	ELL	Ellipse			RAR	Rustic Arch Rose	260	Polished Chrome	
				FED	Federal			RSR	Rustic Square Rose	055	Polished Nickel PVD	
				ROU	Round					190	Satin Black	
				RUS	Rustic						Contemporary Styles	
				SQU	Square						112	Venetian Bronze
				TAP	Taper						044	Satin Brass PVD
				TRA	Traditional						150	Satin Nickel
				TUB	Tube						260	Polished Chrome
											055	Polished Nickel PVD
											190	Satin Black
												Rustic Styles
											481	Dark Bronze
											492	White Bronze

HANDLESETS

2. Options – Add additional customization with the following optional features:

STD		6L		DS		SMT		K2	
Door Thickness		Latch		Strike		Cylinder		Keying	
STD	1.75" to 2" Doors*	6L	6 Way Latch*	DS	Dual Strike Kit*	CKY SMT	C-Keyway Pin & Tumbler* SmartKey	KD KA CK KC MK WITH	Keyed Different* Keyed Alike (A=#) Construction Key Key Code Master Key Separate Lines Keyed Together

NOTES

- Handing only required when ordering with lever interior style and is always measured from the exterior of the door.
- Rose style will determine interior deadbolt turnpiece style.
- Dummy handlesets use a Single Cylinder interior style (with non-functioning turnpiece)
- Indicate exterior x interior finish when ordering split finishes - if single finish, specify only once.

OPTIONS NOTES

*Orders will ship with default options in bold unless otherwise specified.

Thick and Thin Door Service Part Kits are available for order (pg.51).
UL Latch Service Part Kits are available for order (pg.48).

DEADBOLTS

2. Options – Add additional customization with the following optional features:

STD		6L		DS		CKY		N/A	
Door Thickness		Latch		Strike		Cylinder		Keying	
STD	1.75" to 2" Doors*	6L	6 Way Latch*	DS FS	Dual Strike Kit* Full Lip Deadbolt Strike	CKY SMT	C-Keyway Pin & Tumbler* SmartKey	KD KA CK KC MK WITH	Keyed Different* Keyed Alike (A=#) Construction Key Key Code Master Key Separate Lines Keyed Together

NOTES

- Indicate exterior x interior style or finish when ordering split styles or finishes - if single style or finish, specify only once.

OPTIONS NOTES

*Orders will ship with default options in bold unless otherwise specified.

Thick and Thin Door Service Part Kits are available for order (pg.51).
UL Latch Service Part Kits are available for order (pg.48).

KNOBS

2. Options – Add additional customization with the following optional features:

STD		6L		DS		N/A	
Door Thickness		Latch		Strike		Keying	
STD	1.375" to 2" Doors*	6L	6 Way Latch*	DS	Dual Strike Kit*	KD KA CK KC MK WITH	Keyed Different* Keyed Alike (A=#) Construction Key Key Code Master Key Separate Lines Keyed Together

NOTES

- Handing only required when ordering with lever interior style and is always measured from the exterior of the door.
- Indicate exterior x interior style, rose, or finish when ordering split styles, roses, or finishes - if single style, rose, or finish, specify only once.

OPTIONS NOTES

*Orders will ship with default options in bold unless otherwise specified.

Available with C-Keyway cylinder only.

Thick and Thin Door Service Part Kits are available for order (pg.51).
UL Latch Service Part Kits are available for order (pg.48).

LEVERS

2. Options – Add additional customization with the following optional features:

STD		6L		DS		KD	
Door Thickness		Latch		Strike		Keying	
STD	1.375" to 2" Doors*	6L	6 Way Latch*	DS	Dual Strike Kit*	KD KA CK KC MK WITH	Keyed Different* Keyed Alike (A=#) Construction Key Key Code Master Key Separate Lines Keyed Together

NOTES

- Handing required when ordering half dummy function, and with orders that will be split finish, split lever style, or split with a knob. Handing always measured from the exterior of the door.
- Indicate Exterior x Interior style, rose, or finish when ordering split styles, roses, or finishes - if single style, rose, or finish, specify only once.

OPTIONS NOTES

*Orders will ship with default options in bold unless otherwise specified.

Available with C-Keyway cylinder only.

Thick and Thin Door Service Part Kits are available for order (pg.51).
UL Latch Service Part Kits are available for order (pg.48).

TRADITIONAL HANDLESETS



COL



NAP







WES



CHE

*Note: Interior roses have exposed screws.

Function	Style	Interior Knob or Lever*	Handing	Interior Rose	Finish	List Price
(SC) Single Cylinder (DC) Double Cylinder (FD) Full Dummy		(ROU) Round (ELL) Ellipse (TRA) Traditional	N/A	(TRR) Traditional Round Rose (TAR) Traditional Arch Rose (TSR) Traditional Square Rose	(003) Polished Brass PVD (044) Satin Brass PVD (150) Satin Nickel (152) Matte Antique Nickel (112) Venetian Bronze (260) Polished Chrome (055) Polished Nickel PVD (190) Satin Black	\$409.00
		(CUR) Curve (FED) Federal (DEC) Decorative	(R) Right Hand (L) Left Hand			
(SC) Single Cylinder (DC) Double Cylinder (FD) Full Dummy		(ROU) Round (ELL) Ellipse (TRA) Traditional	N/A	(TRR) Traditional Round Rose (TAR) Traditional Arch Rose (TSR) Traditional Square Rose	(003) Polished Brass PVD (044) Satin Brass PVD (150) Satin Nickel (152) Matte Antique Nickel (112) Venetian Bronze (260) Polished Chrome (055) Polished Nickel PVD (190) Satin Black	\$409.00
		(CUR) Curve (FED) Federal (DEC) Decorative	(R) Right Hand (L) Left Hand			
(SC) Single Cylinder (DC) Double Cylinder (FD) Full Dummy		(ROU) Round (ELL) Ellipse (TRA) Traditional	N/A	(TRR) Traditional Round Rose (TAR) Traditional Arch Rose (TSR) Traditional Square Rose	(003) Polished Brass PVD (044) Satin Brass PVD (150) Satin Nickel (152) Matte Antique Nickel (112) Venetian Bronze (260) Polished Chrome (055) Polished Nickel PVD (190) Satin Black	\$409.00
		(CUR) Curve (FED) Federal (DEC) Decorative	(R) Right Hand (L) Left Hand			
(SC) Single Cylinder (DC) Double Cylinder (FD) Full Dummy		(ROU) Round (ELL) Ellipse (TRA) Traditional	N/A	(TRR) Traditional Round Rose (TAR) Traditional Arch Rose (TSR) Traditional Square Rose	(003) Polished Brass PVD (044) Satin Brass PVD (150) Satin Nickel (152) Matte Antique Nickel (112) Venetian Bronze (260) Polished Chrome (055) Polished Nickel PVD (190) Satin Black	\$457.00
		(CUR) Curve (FED) Federal (DEC) Decorative	(R) Right Hand (L) Left Hand			

Additional interior styles available, depending on interior finish.

*Crystal Knob and Interior Escutcheon Plates not available for handleset interiors on this page.

**Thin door option available for 1.375" to 1.75" Single Cylinder and Double Cylinder.

Average Weight	
Single Cylinder (ea)	6.65 lbs.
Double Cylinder (ea)	6.95 lbs.
Dummy Cylinder (ea)	6.03 lbs.

HOW TO ORDER: FUNCTION.STYLE X INTERIOR KNOB OR LEVER.HANDING.ROSE.FINISH



DEL





ELI



NEW

*Note: Interior trims have exposed screws.

Function	Style	Interior Knob or Lever*	Handing	Interior Rose	Finish	List Price
(EE) Emergency Egress (FD) Full Dummy	 (DEL) Del Mar	(ROU) Round (ELL) Ellipse (TRA) Traditional	N/A	(SBE) Square Bevel (TAE) Traditional Arched (EBE) Elizabeth	(003) Polished Brass PVD (044) Satin Brass PVD (150) Satin Nickel (152) Matte Antique Nickel (112) Venetian Bronze (260) Polished Chrome (055) Polished Nickel PVD (190) Satin Black	\$482.00
		(CUR) Curve (FED) Federal (DEC) Decorative	(R) Right Hand (L) Left Hand			
(EE) Emergency Egress (FD) Full Dummy	 (ELI) Elizabeth	(ROU) Round (ELL) Ellipse (TRA) Traditional	N/A	(SBE) Square Bevel (TAE) Traditional Arched (EBE) Elizabeth	(003) Polished Brass PVD (044) Satin Brass PVD (150) Satin Nickel (152) Matte Antique Nickel (112) Venetian Bronze (260) Polished Chrome (055) Polished Nickel PVD (190) Satin Black	\$482.00
		(CUR) Curve (FED) Federal (DEC) Decorative	(R) Right Hand (L) Left Hand			
(EE) Emergency Egress (FD) Full Dummy	 (NEW) New Hampshire	(ROU) Round (ELL) Ellipse (TRA) Traditional	N/A	(SBE) Square Bevel (TAE) Traditional Arched (EBE) Elizabeth	(003) Polished Brass PVD (044) Satin Brass PVD (150) Satin Nickel (152) Matte Antique Nickel (112) Venetian Bronze (260) Polished Chrome (055) Polished Nickel PVD (190) Satin Black	\$482.00
		(CUR) Curve (FED) Federal (DEC) Decorative	(R) Right Hand (L) Left Hand			

Additional interior styles available, depending on interior finish.

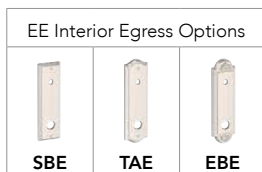

*Crystal knob not available with handleset interior.

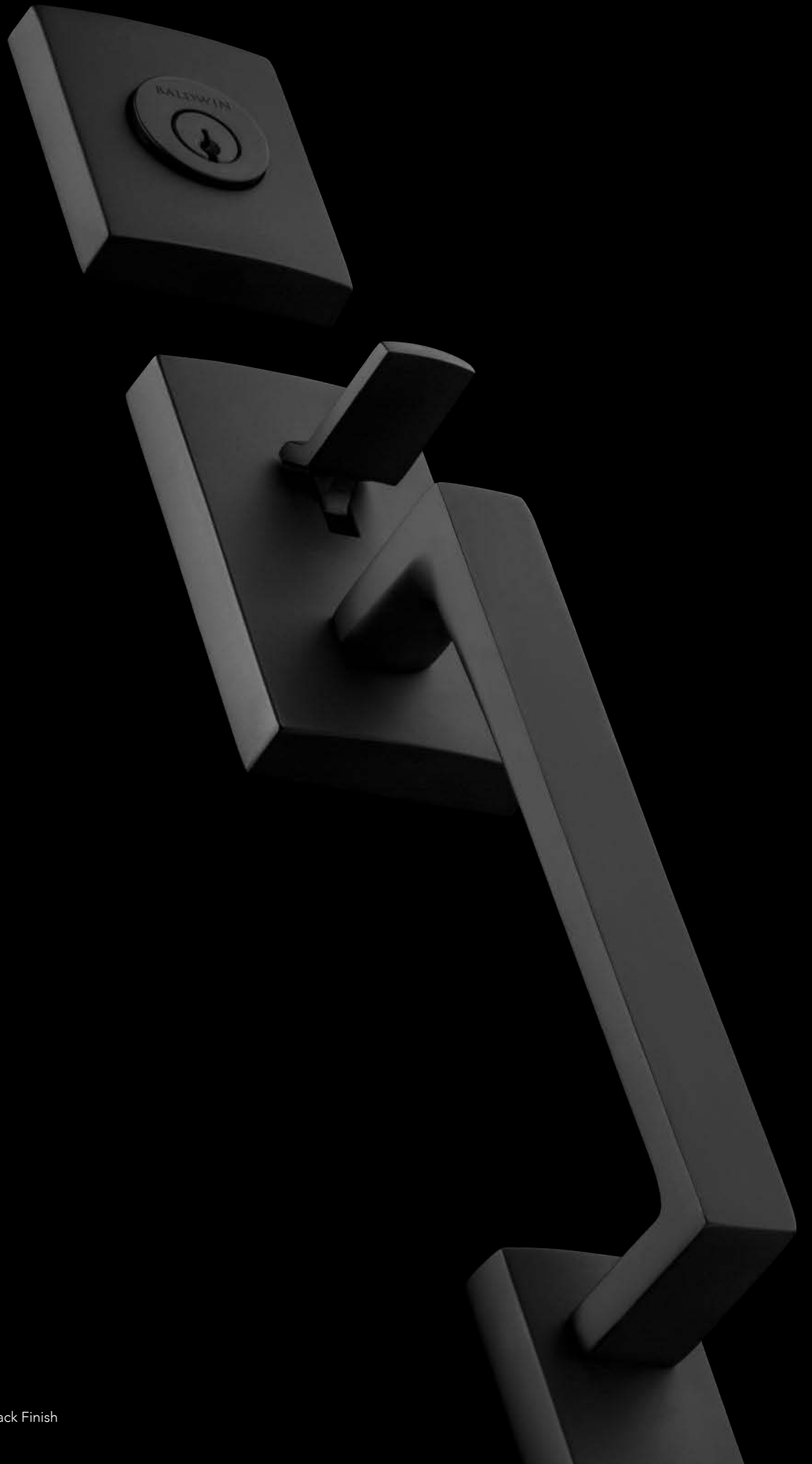

HOW TO ORDER: FUNCTION.STYLE X INTERIOR KNOB OR LEVER.HANDING.ROSE.FINISH











La Jolla Handleset in Satin Black Finish



*Note: Interior roses and trims have exposed screws.

Function	Style	Interior Knob or Lever	Handing	Interior Rose	Finish	List Price
(SC) Single Cylinder (DC) Double Cylinder (FD) Full Dummy	(LAJ) La Jolla	(CON) Contemporary	N/A	(CFR) Contemporary Five Inch Rose*	(150) Satin Nickel	\$409.00
		(TUB) Tube		(CRR) Contemporary Round Rose	(112) Venetian Bronze	
		(SQU) Square		(CSR) Contemporary Square Rose	(044) Satin Brass PVD (260) Polished Chrome (055) Polished Nickel PVD (190) Satin Black	
(EE) Emergency Egress (FD) Full Dummy	(MIA) Miami	(CON) Contemporary	N/A	(CQE) Contemporary Square	(150) Satin Nickel	\$482.00
		(TUB) Tube		(044) Satin Brass PVD	(112) Venetian Bronze	
		(SQU) Square		(260) Polished Chrome (055) Polished Nickel PVD (190) Satin Black		
(EE) Emergency Egress (FD) Full Dummy	(SEA) Seattle	(CON) Contemporary	N/A	(CQE) Contemporary Square	(150) Satin Nickel	\$482.00
		(TUB) Tube		(044) Satin Brass PVD	(112) Venetian Bronze	
		(SQU) Square		(260) Polished Chrome (055) Polished Nickel PVD (190) Satin Black		
(EE) Emergency Egress (FD) Full Dummy	(SAN) Santa Cruz	(CON) Contemporary	N/A	(CQE) Contemporary Square	(150) Satin Nickel	\$568.00
		(TUB) Tube		(044) Satin Brass PVD	(112) Venetian Bronze	
		(SQU) Square		(260) Polished Chrome (055) Polished Nickel PVD (190) Satin Black		

Additional interior styles available, depending on interior finish.
Interior Escutcheon Plates not available on La Jolla handleset.

Average Weight		EE Interior Egress Options			SC/DC Contemporary Rose Options			Contemporary Knobs/Levers			
Single Cylinder (ea)	6.65 lbs.										
Double Cylinder (ea)	6.95 lbs.				CFR	CRR	CSR	CCY	CON	TUB	SQU
Dummy Cylinder (ea)	6.03 lbs.										





HOW TO ORDER: FUNCTION.STYLE X INTERIOR KNOB OR LEVER.HANDING.ROSE.FINISH



Elkhorn Egress in Dark Bronze Finish



*Note: Interior roses and trims have exposed screws.

Function	Style	Interior Knob or Lever	Handing	Interior Rose	Finish	List Price
(SC) Single Cylinder (DC) Double Cylinder (FD) Full Dummy	(ADI) Adirondack 	(RUS) Rustic	N/A	(RAR) Rustic Arch Rose (RSR) Rustic Square Rose	(481) Dark Bronze (492) White Bronze	\$514.00
		(ARC) Arch (TAP) Taper	(R) Right Hand (L) Left Hand			
(EE) Emergency Egress (FD) Full Dummy	(KOD) Kodiak 	(RUS) Rustic	N/A	(RAE) Rustic Arched (SBE) Square Bevel	(481) Dark Bronze (492) White Bronze	\$573.00
		(ARC) Arch (TAP) Taper	(R) Right Hand (L) Left Hand			
(EE) Emergency Egress (FD) Full Dummy	(ELK) Elkhorn 	(RUS) Rustic	N/A	(RAE) Rustic Arched (SBE) Square Bevel	(481) Dark Bronze (492) White Bronze	\$622.00
		(ARC) Arch (TAP) Taper	(R) Right Hand (L) Left Hand			
(EE) Emergency Egress (FD) Full Dummy	(LON) Longview 	(RUS) Rustic	N/A	(RAE) Rustic Arched (SBE) Square Bevel	(481) Dark Bronze (492) White Bronze	\$622.00
		(ARC) Arch (TAP) Taper	(R) Right Hand (L) Left Hand			

Additional interior styles available, depending on interior finish.
Interior Escutcheon Plates not available on Adirondack handleset.

Average Weight	
Single Cylinder (ea)	6.65 lbs.
Double Cylinder (ea)	6.95 lbs.
Dummy Cylinder (ea)	6.03 lbs.

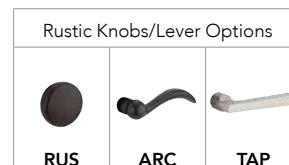

HOW TO ORDER: FUNCTION.STYLE X INTERIOR KNOB OR LEVER.HANDING.ROSE.FINISH

TRADITIONAL DEADBOLTS



TRD



TAD



TSD

*Note: Interior roses and Half Dummy roses have exposed screws.

Function	Style	Finish	List Price
(SC) Single Cylinder	(TRD) Traditional Round Deadbolt*	(003) Polished Brass PVD	\$104.00
(DC) Double Cylinder		(044) Satin Brass PVD (150) Satin Nickel (152) Matte Antique Nickel (112) Venetian Bronze (260) Polished Chrome (055) Polished Nickel PVD (190) Satin Black	\$114.00
(PT) Patio			\$64.00
(SC) Single Cylinder	(TAD) Traditional Arch Deadbolt*	(003) Polished Brass PVD	\$104.00
(DC) Double Cylinder		(044) Satin Brass PVD (150) Satin Nickel (152) Matte Antique Nickel (112) Venetian Bronze (260) Polished Chrome (055) Polished Nickel PVD (190) Satin Black	\$114.00
(PT) Patio			\$64.00
(SC) Single Cylinder	(TSD) Traditional Square Deadbolt*	(003) Polished Brass PVD	\$104.00
(DC) Double Cylinder		(044) Satin Brass PVD (150) Satin Nickel (152) Matte Antique Nickel (112) Venetian Bronze (260) Polished Chrome (055) Polished Nickel PVD (190) Satin Black	\$114.00
(PT) Patio			\$64.00

Thin door kits are available for 1.375" to 1.75".

Average Weight	
Single Cylinder (ea)	2.3 lbs.
Double Cylinder (ea)	2.9 lbs.

HOW TO ORDER: FUNCTION.STYLE.FINISH



CRD



CSD



RAD



RSD

*Note: Interior roses and Half Dummy roses have exposed screws.

Function	Style	Finish	List Price
(SC) Single Cylinder	(CRD) Contemporary Round Deadbolt*	(150) Satin Nickel	\$104.00
(DC) Double Cylinder		(112) Venetian Bronze	\$114.00
(PT) Patio		(044) Satin Brass PVD	\$64.00
		(260) Polished Chrome	
		(055) Polished Nickel PVD	
		(190) Satin Black	
(SC) Single Cylinder	(CSD) Contemporary Square Deadbolt*	(150) Satin Nickel	\$104.00
(DC) Double Cylinder		(112) Venetian Bronze	\$114.00
(PT) Patio		(044) Satin Brass PVD	\$64.00
		(260) Polished Chrome	
		(055) Polished Nickel PVD	
		(190) Satin Black	
(SC) Single Cylinder	(RAD) Rustic Arch Deadbolt**	(481) Dark Bronze	\$121.00
(DC) Double Cylinder		(492) White Bronze	\$132.00
(PT) Patio			\$67.00
(SC) Single Cylinder	(RSD) Rustic Square Deadbolt**	(481) Dark Bronze	\$121.00
(DC) Double Cylinder		(492) White Bronze	\$132.00
(PT) Patio			\$67.00



*Thin door kits are available for 1.375" to 1.75".

**Double cylinder includes swing cover on both exterior and interior. No thin door option available.

HOW TO ORDER: FUNCTION.STYLE.FINISH





*Note: Interior roses and Half Dummy roses have exposed screws.

Function	Style	Rose	Finish	List Price
(EN) Entry*				N/A
(PS) Passage (PV) Privacy (FD) Full Dummy	(CRY) Crystal 	(TRR) Traditional Round Rose (TAR) Traditional Arch Rose (TSR) Traditional Square Rose	(003) Polished Brass PVD (044) Satin Brass PVD (150) Satin Nickel (152) Matte Antique Nickel (112) Venetian Bronze (260) Polished Chrome (055) Polished Nickel PVD (190) Satin Black	\$185.00
(HD) Half Dummy				\$92.00
(EN) Entry				\$237.00
(PS) Passage (PV) Privacy (FD) Full Dummy	(ELL) Ellipse 	(TRR) Traditional Round Rose (TAR) Traditional Arch Rose (TSR) Traditional Square Rose	(003) Polished Brass PVD (044) Satin Brass PVD (150) Satin Nickel (152) Matte Antique Nickel (112) Venetian Bronze (260) Polished Chrome (055) Polished Nickel PVD (190) Satin Black	\$151.00
(HD) Half Dummy				\$75.00
(EN) Entry				\$237.00
(PS) Passage (PV) Privacy (FD) Full Dummy	(ROU) Round 	(TRR) Traditional Round Rose (TAR) Traditional Arch Rose (TSR) Traditional Square Rose	(003) Polished Brass PVD (044) Satin Brass PVD (150) Satin Nickel (152) Matte Antique Nickel (112) Venetian Bronze (260) Polished Chrome (055) Polished Nickel PVD (190) Satin Black	\$151.00
(HD) Half Dummy				\$75.00

Other roses available, depending on finish.
Entry knobs and levers available with C-Keyway pin and tumbler cylinder only.

*Entry function not available.





Average Weight	
Passage/Privacy Knob (ea)	3.05 lbs.
Entry Knob (ea)	3.04 lbs.
Full Dummy Lever (ea)	2.48 lbs.
Half Dummy Lever (ea)	1.3 lbs.

Traditional Rose Options		
		
TRR	TAR	TSR

HOW TO ORDER: FUNCTION.STYLE.ROSE.FINISH



*Note: Interior roses and Half Dummy roses have exposed screws.

Function	Style	Rose	Finish	List Price
(EN) Entry	(TRA) Traditional 	(TRR) Traditional Round Rose (TAR) Traditional Arch Rose (TSR) Traditional Square Rose	(003) Polished Brass PVD	\$237.00
(PS) Passage (PV) Privacy (FD) Full Dummy			(044) Satin Brass PVD (150) Satin Nickel (152) Matte Antique Nickel (112) Venetian Bronze	\$151.00
(HD) Half Dummy			(260) Polished Chrome (055) Polished Nickel PVD (190) Satin Black	\$75.00
(PS) Passage (PV) Privacy (FD) Full Dummy	(CCY) Contemporary Crystal 	(CFR) Contemporary Five Inch Rose* (CRR) Contemporary Round Rose (CSR) Contemporary Square Rose *\$5 List Cost Adder Per Rose	(150) Satin Nickel (112) Venetian Bronze	\$187.00
(HD) Half Dummy			(044) Satin Brass PVD (260) Polished Chrome (055) Polished Nickel PVD (190) Satin Black	\$93.00
(EN) Entry	(CON) Contemporary 	(CFR) Contemporary Five Inch Rose* (CRR) Contemporary Round Rose (CSR) Contemporary Square Rose *\$5 List Cost Adder Per Rose	(150) Satin Nickel (112) Venetian Bronze	\$247.00
(PS) Passage (PV) Privacy (FD) Full Dummy			(044) Satin Brass PVD (260) Polished Chrome (055) Polished Nickel PVD	\$187.00
(HD) Half Dummy			(190) Satin Black	\$93.00
(EN) Entry	(RUS) Rustic 	(RAR) Rustic Arch Rose (RSR) Rustic Square Rose		\$256.00
(PS) Passage (PV) Privacy (FD) Full Dummy			(481) Dark Bronze (492) White Bronze	\$191.00
(HD) Half Dummy				\$95.00

Other roses available, depending on finish.
Entry knobs and levers available with C-Keyway pin and tumbler cylinder only.

Traditional Rose Options			Contemporary Rose Options			Rustic Rose Options	
							
TRR	TAR	TSR	CFR	CRR	CSR	RAR	RSR

HOW TO ORDER: FUNCTION.STYLE X INTERIOR KNOB OR LEVER.HANDING.ROSE.FINISH

TRADITIONAL LEVERS



CUR.TRR





DEC.TAR





FED.TSR

*Note: Interior roses and Half Dummy roses have exposed screws.

Function	Style	Handing	Rose	Finish	List Price
(EN) Entry		(R) Right Hand (L) Left Hand	(TRR) Traditional Round Rose (TAR) Traditional Arch Rose (TSR) Traditional Square Rose	(003) Polished Brass PVD	\$237.00
(PS) Passage (PV) Privacy (FD) Full Dummy				(044) Satin Brass PVD (150) Satin Nickel (152) Matte Antique Nickel (112) Venetian Bronze (260) Polished Chrome (055) Polished Nickel PVD (190) Satin Black	\$151.00
(HD) Half Dummy					\$75.00
(EN) Entry		N/A	(TRR) Traditional Round Rose (TAR) Traditional Arch Rose (TSR) Traditional Square Rose	(003) Polished Brass PVD	\$237.00
(PS) Passage (PV) Privacy (FD) Full Dummy				(044) Satin Brass PVD (150) Satin Nickel (152) Matte Antique Nickel (112) Venetian Bronze (260) Polished Chrome (055) Polished Nickel PVD (190) Satin Black	\$151.00
(HD) Half Dummy					\$75.00
(EN) Entry		N/A	(TRR) Traditional Round Rose (TAR) Traditional Arch Rose (TSR) Traditional Square Rose	(003) Polished Brass PVD	\$237.00
(PS) Passage (PV) Privacy (FD) Full Dummy				(044) Satin Brass PVD (150) Satin Nickel (152) Matte Antique Nickel (112) Venetian Bronze (260) Polished Chrome (055) Polished Nickel PVD (190) Satin Black	\$151.00
(HD) Half Dummy					\$75.00

*Handing required for Half Dummy function and split style or split finish orders. Other roses available, depending on finish. Entry knobs and levers available with C-Keyway pin and tumbler cylinder only.

Average Weight	
Passage/Privacy Lever (ea)	3.05 lbs.
Entry Lever (ea)	3.40 lbs.
Full Dummy Lever (ea)	2.48 lbs.
Half Dummy Lever (ea)	1.3 lbs.

Traditional Rose Options		
		
TRR	TAR	TSR

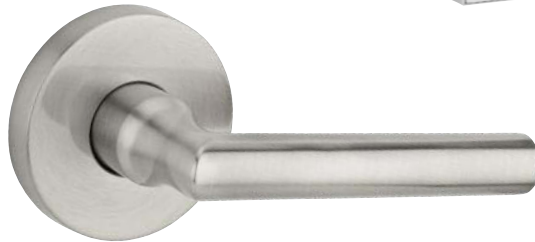

HOW TO ORDER: FUNCTION.STYLE.ROSE.FINISH



TUB.CRR



SQU.CSR

*Note: Interior roses and Half Dummy roses have exposed screws.

Function	Style	Handing*	Rose	Finish	List Price
(EN) Entry					\$237.00
(PS) Passage (PV) Privacy (FD) Full Dummy	(TUB) Tube 	N/A	(CFR) Contemporary Five Inch Rose* (CRR) Contemporary Round Rose (CSR) Contemporary Square Rose <small>*\$5 List Cost Adder Per Rose</small>	(150) Satin Nickel (112) Venetian Bronze (044) Satin Brass PVD (260) Polished Chrome (055) Polished Nickel PVD (190) Satin Black	\$151.00
(HD) Half Dummy					\$75.00
(EN) Entry					\$237.00
(PS) Passage (PV) Privacy (FD) Full Dummy	(SQU) Square 	N/A	(CFR) Contemporary Five Inch Rose* (CRR) Contemporary Round Rose (CSR) Contemporary Square Rose <small>*\$5 List Cost Adder Per Rose</small>	(150) Satin Nickel (112) Venetian Bronze (044) Satin Brass PVD (260) Polished Chrome (055) Polished Nickel PVD (190) Satin Black	\$151.00
(HD) Half Dummy					\$75.00

*Handing not required for TUB and SQU styles.
Other roses available, depending on finish.
Entry knobs and levers available with C-Keyway pin and tumbler cylinder only.

Average Weight	
Passage/Privacy Lever (ea)	3.05 lbs.
Entry Lever (ea)	3.40 lbs.
Full Dummy Lever (ea)	2.48 lbs.
Half Dummy Lever (ea)	1.3 lbs.

Contemporary Rose Options		
		
CFR	CRR	CSR

HOW TO ORDER: FUNCTION.STYLE X INTERIOR KNOB OR LEVER.HANDING.ROSE.FINISH

RUSTIC LEVERS



ARC.RAR



TAP.RSR

*Note: Interior roses and Half Dummy roses have exposed screws.

Function	Style	Handing*	Rose	Finish	List Price
(EN) Entry					\$256.00
(PS) Passage (PV) Privacy (FD) Full Dummy	(ARC) Arch*	(R) Right Hand (L) Left Hand	(RAR) Rustic Arch Rose (RSR) Rustic Square Rose	(481) Dark Bronze (492) White Bronze	\$191.00
(HD) Half Dummy					\$95.00
(EN) Entry					\$256.00
(PS) Passage (PV) Privacy (FD) Full Dummy	(TAP) Taper	N/A	(RAR) Rustic Arch Rose (RSR) Rustic Square Rose	(481) Dark Bronze (492) White Bronze	\$191.00
(HD) Half Dummy					\$95.00

*Handing required for Half Dummy function and split style or split finish orders.

Average Weight	
Passage/Privacy Lever (ea)	3.05 lbs.
Entry Lever (ea)	3.40 lbs.
Full Dummy Lever (ea)	2.48 lbs.
Half Dummy Lever (ea)	1.3 lbs.

Rustic Rose Options	
 RAR	 RSR

HOW TO ORDER: FUNCTION.STYLE X INTERIOR KNOB OR LEVER.HANDING.ROSE.FINISH



Chesapeake Multipoint in Lifetime (PVD) Satin Brass Finish



CHE



DEL



SEA







ELK



LON

*Note: Interior trim has exposed screws.

Function	Style	Interior Lever	Handing	Finish	Configuration	List Price
(EN) Entry (PT) Patio (AI) Active Inactive (FD) Full Dummy	(CHE) Chesapeake 	(CUR) Curve (FED) Federal (DEC) Decorative	(R) Right Hand (L) Left Hand	(003) Polished Brass PVD (044) Satin Brass PVD (150) Satin Nickel (152) Matte Antique Nickel (112) Venetian Bronze (260) Polished Chrome (055) Polished Nickel PVD (190) Satin Black (049) Matte Brass and Black <i>While Supplies Last</i>	C3 (Configuration 3) C4 (Configuration 4) C6 (Configuration 6)	\$291.00
				(003) Polished Brass PVD (044) Satin Brass PVD (150) Satin Nickel (152) Matte Antique Nickel (112) Venetian Bronze (260) Polished Chrome (055) Polished Nickel PVD (190) Satin Black (049) Matte Brass and Black <i>While Supplies Last</i>	C3 (Configuration 3) C4 (Configuration 4) C6 (Configuration 6)	
				(003) Polished Brass PVD (044) Satin Brass PVD (150) Satin Nickel (152) Matte Antique Nickel (112) Venetian Bronze (260) Polished Chrome (055) Polished Nickel PVD (190) Satin Black (049) Matte Brass and Black <i>While Supplies Last</i>	C3 (Configuration 3) C4 (Configuration 4) C6 (Configuration 6)	
				(003) Polished Brass PVD (044) Satin Brass PVD (150) Satin Nickel (152) Matte Antique Nickel (112) Venetian Bronze (260) Polished Chrome (055) Polished Nickel PVD (190) Satin Black (049) Matte Brass and Black <i>While Supplies Last</i>	C3 (Configuration 3) C4 (Configuration 4) C6 (Configuration 6)	
				(003) Polished Brass PVD (044) Satin Brass PVD (150) Satin Nickel (152) Matte Antique Nickel (112) Venetian Bronze (260) Polished Chrome (055) Polished Nickel PVD (190) Satin Black (049) Matte Brass and Black <i>While Supplies Last</i>	C3 (Configuration 3) C4 (Configuration 4) C6 (Configuration 6)	
(EN) Entry (PT) Patio (AI) Active Inactive (FD) Full Dummy	(DEL) Del Mar 	(CUR) Curve (FED) Federal (DEC) Decorative	(R) Right Hand (L) Left Hand	(003) Polished Brass PVD (044) Satin Brass PVD (150) Satin Nickel (152) Matte Antique Nickel (112) Venetian Bronze (260) Polished Chrome (055) Polished Nickel PVD (190) Satin Black (049) Matte Brass and Black <i>While Supplies Last</i>	C3 (Configuration 3) C4 (Configuration 4) C6 (Configuration 6)	\$291.00
				(003) Polished Brass PVD (044) Satin Brass PVD (150) Satin Nickel (152) Matte Antique Nickel (112) Venetian Bronze (260) Polished Chrome (055) Polished Nickel PVD (190) Satin Black (049) Matte Brass and Black <i>While Supplies Last</i>	C3 (Configuration 3) C4 (Configuration 4) C6 (Configuration 6)	
				(003) Polished Brass PVD (044) Satin Brass PVD (150) Satin Nickel (152) Matte Antique Nickel (112) Venetian Bronze (260) Polished Chrome (055) Polished Nickel PVD (190) Satin Black (049) Matte Brass and Black <i>While Supplies Last</i>	C3 (Configuration 3) C4 (Configuration 4) C6 (Configuration 6)	
				(003) Polished Brass PVD (044) Satin Brass PVD (150) Satin Nickel (152) Matte Antique Nickel (112) Venetian Bronze (260) Polished Chrome (055) Polished Nickel PVD (190) Satin Black (049) Matte Brass and Black <i>While Supplies Last</i>	C3 (Configuration 3) C4 (Configuration 4) C6 (Configuration 6)	
				(003) Polished Brass PVD (044) Satin Brass PVD (150) Satin Nickel (152) Matte Antique Nickel (112) Venetian Bronze (260) Polished Chrome (055) Polished Nickel PVD (190) Satin Black (049) Matte Brass and Black <i>While Supplies Last</i>	C3 (Configuration 3) C4 (Configuration 4) C6 (Configuration 6)	
(EN) Entry (PT) Patio (AI) Active Inactive (FD) Full Dummy	(SEA) Seattle 	(SQU) Square (TUB) Tube	N/A	(150) Satin Nickel (112) Venetian Bronze (044) Satin Brass PVD (260) Polished Chrome (055) Polished Nickel PVD (190) Satin Black	C3 (Configuration 3) C4 (Configuration 4) C6 (Configuration 6)	\$291.00
				(150) Satin Nickel (112) Venetian Bronze (044) Satin Brass PVD (260) Polished Chrome (055) Polished Nickel PVD (190) Satin Black	C3 (Configuration 3) C4 (Configuration 4) C6 (Configuration 6)	
				(150) Satin Nickel (112) Venetian Bronze (044) Satin Brass PVD (260) Polished Chrome (055) Polished Nickel PVD (190) Satin Black	C3 (Configuration 3) C4 (Configuration 4) C6 (Configuration 6)	
				(150) Satin Nickel (112) Venetian Bronze (044) Satin Brass PVD (260) Polished Chrome (055) Polished Nickel PVD (190) Satin Black	C3 (Configuration 3) C4 (Configuration 4) C6 (Configuration 6)	
				(150) Satin Nickel (112) Venetian Bronze (044) Satin Brass PVD (260) Polished Chrome (055) Polished Nickel PVD (190) Satin Black	C3 (Configuration 3) C4 (Configuration 4) C6 (Configuration 6)	
(EN) Entry (PT) Patio (AI) Active Inactive (FD) Full Dummy	(ELK) Elkhorn 	(ARC) Arch (TAP) Taper	(R) Right Hand (L) Left Hand	(481) Dark Bronze (492) White Bronze	C3 (Configuration 3) C4 (Configuration 4) C6 (Configuration 6)	\$327.00
				(481) Dark Bronze (492) White Bronze	C3 (Configuration 3) C4 (Configuration 4) C6 (Configuration 6)	
				(481) Dark Bronze (492) White Bronze	C3 (Configuration 3) C4 (Configuration 4) C6 (Configuration 6)	
				(481) Dark Bronze (492) White Bronze	C3 (Configuration 3) C4 (Configuration 4) C6 (Configuration 6)	
				(481) Dark Bronze (492) White Bronze	C3 (Configuration 3) C4 (Configuration 4) C6 (Configuration 6)	
(EN) Entry (PT) Patio (AI) Active Inactive (FD) Full Dummy	(LON) Longview 	(ARC) Arch (TAP) Taper	(R) Right Hand (L) Left Hand	(481) Dark Bronze (492) White Bronze	C3 (Configuration 3) C4 (Configuration 4) C6 (Configuration 6)	\$327.00
				(481) Dark Bronze (492) White Bronze	C3 (Configuration 3) C4 (Configuration 4) C6 (Configuration 6)	
				(481) Dark Bronze (492) White Bronze	C3 (Configuration 3) C4 (Configuration 4) C6 (Configuration 6)	
				(481) Dark Bronze (492) White Bronze	C3 (Configuration 3) C4 (Configuration 4) C6 (Configuration 6)	
				(481) Dark Bronze (492) White Bronze	C3 (Configuration 3) C4 (Configuration 4) C6 (Configuration 6)	

Multipoint trims fit up to a 2-1/4" thick door.

HOW TO ORDER

Example: "I need a Configuration 4 entry multipoint in Longview with a Taper lever in dark bronze finish."

NOTES

- Handing required when ordering with lever interior style and is always measured from the exterior of the door.
- Indicate exterior x interior finish when ordering split finishes - if single finish, specify only once.

OPTIONS NOTES

*Orders will ship with default options in bold unless otherwise specified.

1. Start your order configuration with the following required information:

EN		LON		TAP		R		481		C4		CKY		KD	
Function		Style Exterior		Interior Lever		Handing		Finish Exterior X Interior		Configuration		Cylinder		Keying	
EN	Entry	CHE	Chesapeake	CUR	Curve	R	Right	003	Traditional Styles	C3	Configuration 3	CKY	C-Keyway Pin & Tumbler*	KD	Keyed Different*
PT	Patio	DEL	Del Mar	DEC	Decorative	L	Left	044	Polished Brass PVD	C4	Configuration 4			KA	Keyed Alike (A=#)
AI	Active Inactive	SEA	Seattle	FED	Federal			112	Satin Brass PVD	C6	Configuration 6			CK	Construction Key
FD	Full Dummy	ELK	Elkhorn	SQU	Square			150	Venetian Bronze					KC	Key Code
		LON	Longview	TUB	Tube			152	Satin Nickel					MK	Master Key
				ARC	Arch			260	Matte Antique Nickel					WITH	Separate Lines
				TAP	Taper			055	Polished Chrome						Keyed Together
								190	Polished Nickel PVD						
								190	Satin Black						
									Contemporary Styles						
								112	Venetian Bronze						
								044	Satin Brass PVD						
								150	Satin Nickel						
								260	Polished Chrome						
								055	Polished Nickel PVD						
								190	Satin Black						
									Rustic Styles						
								481	Dark Bronze						
								492	White Bronze						

CONFIGURATION

Average Weight	
Multipoint Entry (ea)	4.45 lbs.
Multipoint Patio (ea)	4.25 lbs.
Multipoint Active/Inactive (ea)	3.55 lbs.
Multipoint Full Dummy (ea)	3.65 lbs.

Baldwin Configuration	Cylinder	Lock CTC	Mounting CTC	Common Brands
3	Below	3 5/8" (92 mm)	8 3/8"	Pella
4	Below	3 5/8" (92 mm)	7 7/8"	G-U, Hoppe, Kolbe & Kolbe, Loewen, Weathershield
6	Above	3 5/8" (92 mm)	7 1/4"	Ashland, JELD-WEN, Milgard & Marvin

Configuration Key

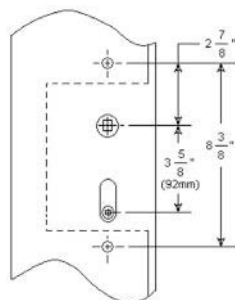

Configuration 3

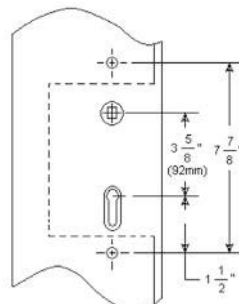

Configuration 4

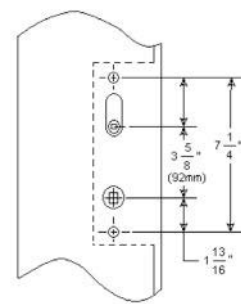

Configuration 6



Contemporary Door Knockers in Multiple Finishes

DOOR ACCESSORIES

In some instances within the following Accessories offering, Estate like finishes are used to support unique Reserve finishes or in areas where PVD finishing is not possible, a lacquer finish is offered in its place.

Quick Ship is designed to expedite shipping of the most popular Baldwin Estate styles and finishes. Orders will be processed and shipped within business five days after order confirmation. All finishes in red are part of Quick Ship. Finishes in black will ship at standard Estate 4 week lead times.

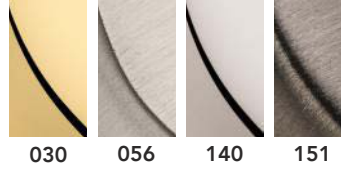

- 030 - Polished Brass (Non PVD version of Polished Brass)
- 056 - Lifetime PVD Satin Nickel
- 140 - Polished Nickel (Non PVD version of Polished Nickel)
- 151 - Antique Nickel (closely resembles 152 Matte Antique Nickel)

0113
"S" Knocker



Item #	Description	Per Box	Wt.	003, 044, 055, 056 112, 151, 190, 260
0113.xxx	"S" Knocker	1	1.8	\$192

SIZE: 2" dia. base (51mm), 7.8" ht. (197mm), 2.8" projection (70mm)
CTC OF BOLTS: 4.75" (120mm)

PACKED: One (1) in a box, poly-bagged, with proper fasteners for 1.75" thick doors

0183
Contemporary Knocker

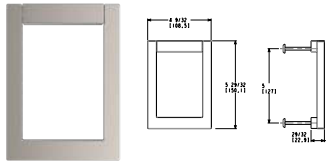

Item #	Description	Per Box	Wt.	003, 044, 055, 056 112, 190, 260
0183.xxx	Contemporary Knocker	1	1.05	\$182

SIZE: 2" dia. base (51mm), 7.8" ht. (197mm), 2.8" projection (70mm)
CTC OF BOLTS: 4.75" (120mm)

PACKED: One (1) in a box, poly-bagged, with proper fasteners for 1.75" thick doors

Estate finishes 402 (Dark Bronze 481) and 452 (White Bronze 481) best align with Reserve Rustic finishes.

0195
Ring Knocker



Item #	Description	Per Box	Wt.	003, 044, 055, 056 112, 151, 190, 260
0195.xxx	Ring Knocker	1	1.5	\$165

SIZE: 4.25" x 5.5" (108 x 140mm)
CTC OF BOLTS: 3.75" (95mm)

PACKED: One (1) in a box, poly-bagged, with proper fasteners for 1.75" thick doors

4860
Rectangular Bell Button

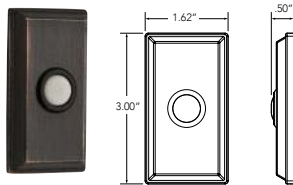

Item #	Description	Per Box	Wt.	003, 044, 055, 056 112, 151, 190, 260
4860.xxx	Rectangular Bell Button	1	0.025	\$45

SIZE: 1.62" x 3"

FEATURES Brass construction with concealed fasteners. Illuminated button for easy detection at night. Recommended for use with up to 24 volt transformers. Available as a complete set with mounting hardware.

4861
Oval Bell Button

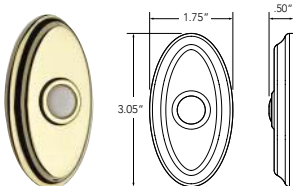

Item #	Description	Per Box	Wt.	003, 044, 055, 056 112, 151, 190, 260
4861.xxx	Oval Bell Button	1	0.025	\$45

SIZE: 1.75" x 3.05"

FEATURES Brass construction with concealed fasteners. Illuminated button for easy detection at night. Recommended for use with up to 24 volt transformers. Available as a complete set with mounting hardware.

4862
Arch Bell Button

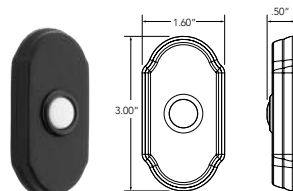

Item #	Description	Per Box	Wt.	003, 044, 055, 056 112, 152, 190, 260 481, 492
4862.xxx	Arch Bell Button	1	0.025	\$45

SIZE: 1.60" x 3"

FEATURES: Brass construction with concealed fasteners. Illuminated button for easy detection at night. Recommended for use with up to 24 volt transformers. Available as a complete set with mounting hardware.

DOOR ACCESSORIES

4863

Contemporary Bell Buttons

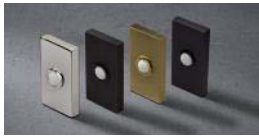

Contemporary Bell Buttons in various finishes

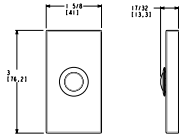

Item #	Description	Per Box	Wt.	003, 044, 055, 056 112, 151, 190, 260
4863.xxx	Contemporary Bell Button	1	0.025	\$45

SIZE: 2" x 5.92"

FEATURES: Solid brass construction. Available as a complete set with mounting hardware, installation instructions and drill template. Mounted with through-holes and fits 1-3/4" doors. Uses 10-24 thru-bolts.

0155, 0156

Observascope

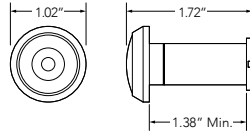

Item #	Description	Per Box	Wt.	030, 260
0155.xxx	Observ-O-Scope (doors <2.25" thick)	10	0.06	\$21
0156.xxx	Observ-O-Scope (doors 2.25-3.25" thick)	10	0.06	\$23

SIZE: 5" (13mm) diameter quality lens

FEATURES: Exterior lens constructed of scientific glass to prohibit scratching while creating a field of vision exceeding 160°. All viewers are furnished with a shutter.

INSTALLATION: Drill a .5" (13mm) hole completely through the door; insert the lens portion into the exterior side and the slotted scope portion through the interior side. Tighten together with a standard screwdriver.

0465

Edge Pull

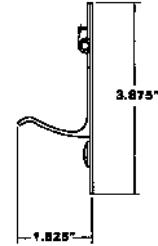

Item #	Description	Per Box	Wt.	003, 044, 055, 056 112, 151, 190, 260
0465.xxx	Edge Pull - .75" x 1.625" x 3.875"	1	1.2	\$22

FEATURES: Specially designed spring loaded Edge Pull returns lever flush with face plate. Narrow design eliminates installation problems on thin door conditions. Intended for use on pocket door applications.

PACKED: Includes wood screws

FEDERAL SPECIFICATION EQUIVALENTS: Government Type: 1861

BHMA DESIGNATION: D2801

NOTES: Not recommended for doors larger than 3.0' x 6'8" x 1.75" thick.

0425, 0426

Adjustable Bell Catch

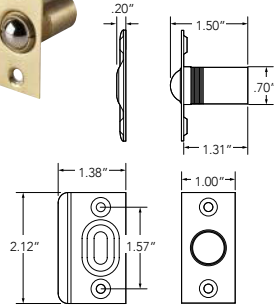

Item #	Description	Per Box	Wt.	003, 044, 055, 056 112, 151, 190, 260
0425.xxx	Adjustable Ball Catch (fitted in jamb)	1	2.1	\$28
0426.xxx	Adjustable Ball Catch (fitted in door)	1	2.2	\$28

SIZE: Face Plate: 1" x 2.125" (25 x 54mm)

Bore: .875" dia. x 1.25" long (22 x 32mm)

0425.xxx Strike: 1.06" x 2.125", Lip to Center: .56"

0426.xxx Strike: 1.375" x 2.125", Lip to Center: .875"

FEATURES: Dual adjustment ball bearing catch of excellent design takes advantage of rolling ball action for perfect tension. Infinite adjustments for compensation of various door clearances, swelling, shrinking, drafts and weights. Recommended for use on louvered, bi-folding, accordion, closet and light to medium service doors.

PACKED: Includes wood screws

FEDERAL SPECIFICATION EQUIVALENTS: Government Type: 1861

BHMA DESIGNATION: D2801

NOTES: Not recommended for doors larger than 3.0' x 6.8" x 1.75" thick.

0600, 0626

Flush Bolts

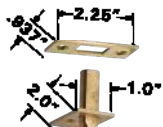

Item #	Description	Wt.	003, 044, 055, 056 112, 151, 190, 260
0600.xxx.12	Flush Bolt w/ 12" Rod (Standard)	1.8	\$75
0600.xxx.18	Flush Bolt w/ 18" Rod	1.8	\$75
0600.xxx.24	Flush Bolt w/ 24" Rod	1.8	\$75
0626.xxx*	Flush Bolt - 6"	3.8	\$32

*Not available in 055

0600.xxx

SIZE: Face Plate: 1" x 6.75" (25mm x 171mm).

Bolt Head: .5" (13mm). Rod Backset: .75" (19mm).

FEATURES: Hot forged extension bolt having over .75" (19mm) throw. Unique push button design of lever and delay action for easy operation. Lever does not engage the bolt until it is hinged freely to 45 angle. At this position it is easy to move the bolt head. Lever snaps automatically when hinged beyond 45 angle. Made to template for easy installation in metal door frames. Use of strike optional.

PACKED: One in a box with 12" (305mm) rods standard. Bolts packed with machine/wood screws for all conditions. Lengths given are from center of bolt mechanism with bolt retracted.

0626.xxx

SIZE: Throw, .47" Backset of Rod, .5" Bolt Head Diameter.

FEATURES: 6" (152mm) length. Sharply defined edge and recess. Smooth working action with automatic holding spring for both retracted and projected positions.

PACKED: Individually poly-bagged with screws and strike, 10 in a box.

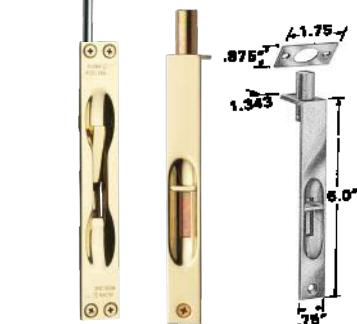

DOOR ACCESSORIES

0321, 0322

General Purpose Surface Bolts
Supplied w/0320 Strikes



Item #	Description	Per Box	Wt.	003, 044, 112, 140 150, 151, 190, 260
0321.xxx	Surface Bolt - 3"	10	1.8	\$36
0322.xxx	Surface Bolt - 4"	10	2.2	\$37

SIZE: .5" (13mm) width rod, .5" (13mm) width of guide, .875" (22mm) throw.
FEATURES: Mounted on a fully concealed guide of special design. Fasteners are not visible.
PACKED: Includes Universal and Mortise Strikes and screws.
BHMA DESIGNATION: L04151

0458
Flush Pull

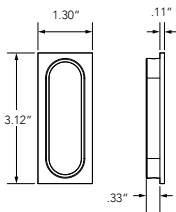

Item #	Description	Wt.	003, 044, 055, 112 150, 151, 190, 260
0458.xxx	Flush Pull, 1.5" x 3.5"	2.7	\$33

SIZE: Base: 1.5" x 3.5" (38 x 89mm)
THICKNESS OF FLANGE: .187" (5mm)
FEATURES: Decorative flush pull designed to be used as a sash lift or sliding door pull if pocket allows clearance. Colonial design makes it suitable for Early American interiors. Extra heavy solid forged brass construction.
NOTE: Pull has .25" projection
PACKED: Includes wood screws.

0452
Sash Lock

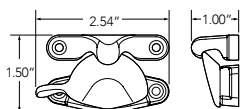

Item #	Description	Wt.	003, 044, 055, 056 112, 151, 190, 260
0452.xxx	Sash Lock	2.2	\$25

SIZE: Latch Base: .968" x 2.437" (25 x 62mm)
Strike Base: .656" x 2.437" (15 x 62mm)
PROJECTION: .906" (23mm)
CTC OF HOLES: .2" (51mm)
FEATURES: Traditional style sash lock with heavy duty spring to provide constant tension for a non-rattling fit. Center to center of mounting screws conforms to industry standards.
PACKED: Includes necessary fasteners.
BHMA DESIGNATION: L05121

0470
Sash Lift

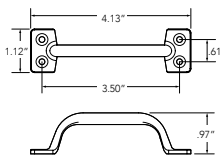

Item #	Description	Wt.	003, 044, 055, 112 150, 151, 190, 260
0470.xxx	Sash Lift, 4" x 1.125"	1	\$28

SIZE: Base: 4" x 1.125" (102 x 29mm)
PROJECTION: .1" (25mm)
PACKED: Includes wood screws.
FEDERAL SPECIFICATION EQUIVALENTS: Government Type: 1204
BHMA DESIGNATION: L05181

4045, 4050
Base Mounted Door Bumpers

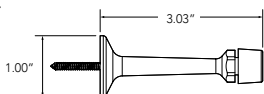

Item #	Description	Per Box	Wt.	003, 044, 055 056, 112, 150 151, 190, 260
4045.xxx	Wall Door Bumper - 3" Proj., 1.1875" Dia.	10	1.8	\$21
4050.xxx	Wall Door Bumper - 3.75" Proj., 1.5" Dia.	10	2.2	\$21

FEATURES: Solid forged brass construction for maximum strength and durability. Stem of bumper has hexagon section to facilitate fastening without damaging finish. Resilient rubber guard is replaceable.
PACKED: Individually poly-bagged with appropriate fasteners (1 per poly bag).
FASTENERS: Supplied with wood screw thread.
FEDERAL SPECIFICATION EQUIVALENTS: Government Type: 1322
BHMA DESIGNATION: L02031

DOOR STOPS

4015, 4252
Convex Wall
Bumpers

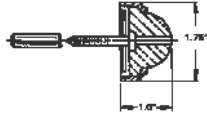
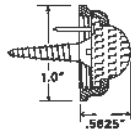

Item #	Description	Per Box	Wt.	003, 044, 055 056, 112, 140 151, 190, 260
4015.xxx**	Wall Flush Bumper - 1" Dia.	1	0.8	\$18
4252.xxx*	Wall Flush Bumper - Convex Design.	1	10	\$18

*Not available in 055
**Not available in 003

4015 FEATURES: Compact designed bumper permits installation in areas where larger bumpers are not suitable due to size or projection. Fasteners are totally concealed underneath durable rubber insert.

4252 FEATURES: Engineered for commercial/residential installations, this compact and contemporary designed bumper features completely concealed fasteners for an unobtrusive and screwless appearance. Supplied with wood and masonry fasteners, it is furnished unassembled to facilitate the substitution of fasteners. Designed for ease of installation, the bumper is attached onto a heavy gauge metal back plate through a threading application. For a fully theft proof installation, the use of a strap wrench for tightening or several drops of Loctite Grade A is recommended.

4252 PACKED: Standard case; individually poly-bagged with appropriate fasteners in a dispensing type carton.

FEDERAL SPECIFICATION EQUIVALENTS: Government Type: 1327 (4252 only)

BHMA DESIGNATION: L02101 (4015 & 4252)

4273, 4293
Concave Wall
Bumpers

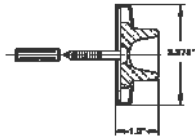
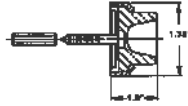

Item #	Description	Per Box	Wt.	003, 044, 112, 140 150, 151, 190, 260
4273.xxx	Wall Flush Bumper - Concave Design 1.75" Dia.	1	9.6	\$18
4293.xxx	Wall Flush Bumper - Concave Design 2.375" Dia.	1	4.5	\$18

4273 FEATURES: Concave type rubber permits knob of button type lock to strike bumper without engaging lock mechanism. Special design protects lock mechanism from damage.

4293 FEATURES: Concave type rubber permits knob of button type lock to strike bumper without engaging lock mechanism. Special design protects lock mechanism from damage.

PACKED: Individually poly-bagged with wood and masonry fasteners in a dispensing type carton.

FEDERAL SPECIFICATION EQUIVALENTS: Government Type: 1327 (4293 only)

BHMA DESIGNATION: L22251 (4273 & 4293)

4000, 4005, 4010
Half Dome
Door Bumper

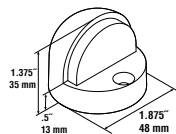
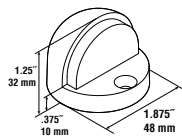
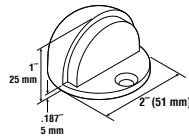

Item #	Description	Per Box	Wt.	003, 044, 112, 140 150, 151, 190, 260
4000.xxx	Half Dome Door Bumper - 1" Ht.	50	12	\$20
4005.xxx	Half Dome Door Bumper - 1.25" Ht.	40	16.6	\$20
4010.xxx	Half Dome Door Bumper - 1.375" Ht.	40	19	\$20

FEATURES: "Half Dome" design minimizes stumbling hazards and cleaning interference. Thick solid rubber bumper of special design is compounded for greater resiliency.

PACKED: Individually poly-bagged with appropriate fasteners in a dispensing type carton.

FASTENERS: Supplied with fasteners for wood, plaster, and masonry installations.

FEDERAL SPECIFICATION EQUIVALENTS: Government Type: 1330/1330A

BHMA DESIGNATION: L02141 (No. 4000)

L02161 (No. 4005/No. 4010)

REPLACEMENT RUBBER: No. 4000.406 for 4000/4005/4010 (Grey)

DOOR ACCESSORIES

1035 3.5"x 3.5" – Square Corner

1035



Item #	Description	Per Box	Wt.	003, 044, 055, 056 112, 151, 190, 260
1035.xxx.I	Hinge – 3.5"x 3.5"	1 each	0.7	\$50
1035.xxx.INRP	Hinge – 3.5"x 3.5"	1 each	0.7	\$60

PACKED: One per box, each hinge poly-bagged with fasteners.
Supplied with 6 – #10 Flat Head-Phillips wood screws.

NOTE: Hinge thickness: .125"

1040 4"x 4" – Square Corner

1040



Item #	Description	Per Box	Wt.	003, 044, 055, 056 112, 151, 190, 260
1040.xxx.I	Hinge – 4"x 4"	1 each	0.8	\$54
1040.xxx.INRP	Hinge – 4"x 4"	1 each	0.8	\$65

PACKED: One per box, each hinge poly-bagged with fasteners.
Supplied with 8 – #12 Flat Head-Phillips wood screws.

NOTE: Hinge thickness: .130"

1135 3.5"x 3.5" – 5/8" Radius Corner

1135



Item #	Description	Per Box	Wt.	003, 044, 055, 056 112, 151, 190, 260
1135.xxx.I	5/8" Radius Corner Hinge – 3.5"x 3.5"	1 each	0.7	\$34

PACKED: One per box, each hinge poly-bagged with fasteners.
Supplied with #10 x 1" Flat Head-Phillips wood screws.

NOTE: NON-REMOVABLE PINS (NRP) NOT AVAILABLE on radius corner hinges.
Hinge thickness: .093"

1140 4"x 4" – 5/8" Radius Corner

1140



Item #	Description	Per Box	Wt.	003, 044, 055, 056 112, 151, 190, 260
1140.xxx.I	5/8" Radius Corner Hinge – 4"x 4"	1 each	0.8	\$38

PACKED: One per box, each hinge poly-bagged with fasteners.
Supplied with #10 x 1" Flat Head-Phillips wood screws.

NOTE: NON-REMOVABLE PINS (NRP) NOT AVAILABLE on radius corner hinges.
Hinge thickness: .090"

1435 3.5"x 3.5" – 1/4" Radius Corner

1435



Item #	Description	Per Box	Wt.	003, 044, 055, 056 112, 151, 190, 260
1435.xxx.I	1/4" Radius Corner Hinge – 3.5"x 3.5"	1 each	0.7	\$34

PACKED: One per box, each hinge poly-bagged with fasteners.
Supplied with #10 x 1" Flat Head-Phillips wood screws.

NOTE: NON-REMOVABLE PINS (NRP) NOT AVAILABLE on radius corner hinges.
Hinge thickness: .093"

1440 4"x 4" – 1/4" Radius Corner

1440



Item #	Description	Per Box	Wt.	003, 044, 055, 056 112, 151, 190, 260
1440.xxx.I	1/4" Radius Corner Hinge – 4"x 4"	1 each	0.8	\$38

PACKED: One per box, each hinge poly-bagged with fasteners.
Supplied with #10 x 1" Flat Head-Phillips wood screws.

NOTE: NON-REMOVABLE PINS (NRP) NOT AVAILABLE on radius corner hinges.
Hinge thickness: .093"

FUNCTIONS

Handlesets	Deadbolts	Knobs/Levers
Single Cylinder (SC) BR180 or BR280	Single Cylinder (SC) BR380	Passage (PS) BR352
		Privacy (PV) BR353
Double Cylinder (DC) BR181	Double Cylinder (DC) BR385	Keyed Entry (EN) BR354
		Full Dummy (FD) BR351 Full Bore Required
Full Dummy (FD) BR182	Patio (PT) BR390	Half Dummy (HD) BR350 Surface Mounted

HANDING

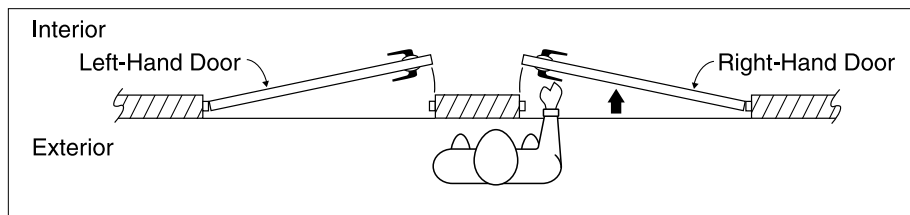

- Handing required for half-dummy levers, handlesets with lever interior, split lever styles (including knob with lever), and split lever finish orders.
- To determine the handing of a door:
 - Facing the door from the EXTERIOR, locate the location of the hinges.
 - If the hinges are located on the left side of the door, the door is left handed (L)
 - If the hinges are located on the right side of the door, the door is right handed (R)

DOOR THICKNESS

	1 3/8" to 1 3/4"	1 3/4" to 2"	2" to 2 1/2"
Handlesets	Optional with Service Part Kit Napa and Westcliff styles, single cylinder and double cylinder only	Standard*	Optional with Service Part Kit
Deadbolts	Optional with Service Part Kit Traditional and Contemporary styles, single cylinder and double cylinder only	Standard*	Optional with Service Part Kit
Patio Deadbolts	Standard		Optional with Service Part Kit
Knobs	Standard		Optional with Service Part Kit
Levers	Standard		Optional with Service Part Kit

*For double cylinder (DC) function, customers will need to replace a torque blade if the application is on a 2" thick door.

LATCH OPTIONS

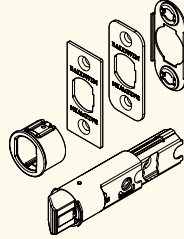
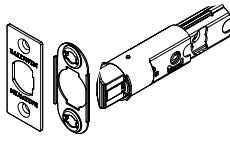
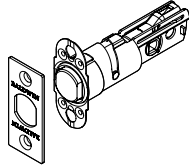
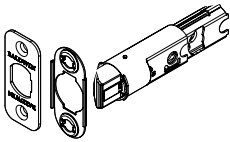
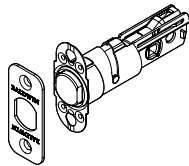
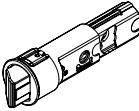
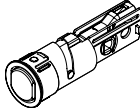
Product Code	Description	List Price Adder	Knobs & Levers	Deadbolts
(6L)	Latch with kit including collar, back plate, and round and square fronts DEFAULT	No Charge		
SLUL	Adjustable latch with Square-Corner Front 20-minute Certified UL	Order separate UL Kit Service Part. Kits listed on pg. 48.		
RLUL	Adjustable latch with Round-Corner Front 20-minute Certified UL	Order separate UL Kit Service Part. Kits listed on pg. 48.		
DIUL	Adjustable latch with Drive-In Collar 20-minute Certified UL	Order separate UL Kit Service Part. Kits listed on pg. 48.		

All latches are adjustable to accommodate 2-3/8" or 2-3/4" backsets.

STRIKE OPTIONS

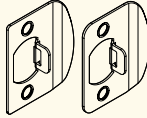
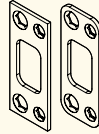
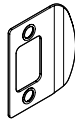
Product Code	Description	List Price Adder	Knobs & Levers	Deadbolts
(DS)	Dual Strike kit that includes both Square Corner & Round Corner Strikes DEFAULT	No Charge		
(FS)	Full Lip Deadbolt Strike	No Charge	N/A	

Extended Lip Square Corner Strike will ship with all thick knob/lever door options (ES)

■ Highlighted box indicates product will ship with default option.

CYLINDER OPTIONS

Product Code	Description	Handlesets	Deadbolts	Knobs & Levers
C-Keyway (CKY)	Baldwin 5-pin pin & tumbler C-Keyway DEFAULT	✓	✓	✓
SmartKey (SMT)	5-pin SmartKey Re-key Technology with KW1 Keyway	✓	✓	N/A

KEYING OPTIONS

Keying	Definition	CKY	SMT	Additional Charge	Notes	Ordering Example
Keyed Different (KD)	Each lock is individually keyed to a different key cut. DEFAULT	✓	✓	No Charge	<ul style="list-style-type: none"> Default keying option for all cylinder types KD orders will receive 1 set of 2 keys cut the same (additional keys can be ordered through the service parts program) 	<p>KD is the default keying option for all cylinder types and does not need to be specified in the order.</p>
Keyed Alike (KA)	All lock are keyed to the same key cut.	✓	✓	No Charge	<ul style="list-style-type: none"> Only available within a given cylinder type; CKY can be keyed to another CKY but can not be keyed to SMT Reserve product can not be ordered keyed alike to other non-Reserve Baldwin products Keyed alike orders will receive 1 set of 4 keys cut the same for the entire series 	<p>All locks on the same line item are keyed alike. Example. 2 SC.TRD.150.K2</p> <ol style="list-style-type: none"> Quantity The line item represents the deadbolt style and finish. K2 represents that the two locks are keyed alike.
With (WITH)	All lock across multiple lines are keyed to the same key cut.	✓	✓	No Charge	<ul style="list-style-type: none"> Only available within a given cylinder type; CKY can be keyed to another CKY but can not be keyed to SMT Reserve product can not be ordered keyed alike to other non-Reserve Baldwin products Keyed alike orders will receive 1 set of 4 keys cut the same for the entire series 	<p>Keys multiple line items of locks together Example. SC.TRD.150.WITH EN.TRA.TRR.150.K2</p> <ol style="list-style-type: none"> Represents end of bundle and total quantity of locks keyed together. Item to be keyed
Key Code (KC)	Customer selects the specific key cut that they would like the cylinder keyed to be keyed to.	✓	✓	No Charge	<ul style="list-style-type: none"> Customer must specify the 5-digit code they would like the cylinders to be keyed to. CKY cuts will range between 0-9 and SMT cuts will range between 1-6 KC keys will not have the key code stamped on the back of the key 	<p>Keys lock to a specific key-cut Example. SC.TRD.150.35829</p> <ol style="list-style-type: none"> Represents customer specified key cut.
Construction Key (CK)	Allows new homes to be keyed to a builder's key during construction only. Once the homeowner uses their key, the builder key is rendered inoperable.	✓		\$15.00	<ul style="list-style-type: none"> Customer must specify builder key code and if home owner's key needs to be keyed alike to other products on order Reserve product can not be ordered keyed alike to other non-Reserve Baldwin products 	<p>Allows a builder to operate a lock during construction. Once the homeowner uses their key, the builder key is rendered inoperable. Example. SC.TRD.150.CK 35829</p> <ol style="list-style-type: none"> CK indicates the cylinder should be Construction Keyed. Represents the builder key code – must be specified when ordering.
Master Key (MK)	Allows multiple keys to operate a single lock. Often used in multi-family applications for owners and tenants.	✓		\$15.00	<ul style="list-style-type: none"> Customer must specify master key code and if home owner's key needs to be keyed alike to other products on order Reserve product can not be ordered keyed alike to other non-Reserve Baldwin products 	<p>Allows maintenance access. Example. SC.TRD.150.MK 59579</p> <ol style="list-style-type: none"> MK indicates the cylinder should be Master Keyed. Represents the Master Key Code – must be specified when ordering.

Please note that Reserve product can not be ordered keyed alike to other Baldwin Prestige Series™ or Estate product.
For service parts, see pages 34-39.

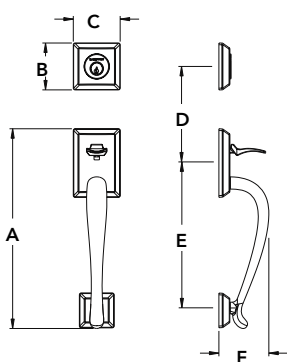

SECTIONAL					
	NAP	COL	WES	LAJ	ADI
A	11-1/2"	12"	12-1/16"	12-15/32"	12-1/16"
B	2-11/16"	3-15/16"	3-7/16"	3-11/32"	3-7/8"
C	2-11/16"	2-11/16"	2-11/16"	2-11/16"	2-11/16"
D	Adjustable	Adjustable	Adjustable	Adjustable	Adjustable
E	8-13/32"	8-13/32"	8-13/32"	8-13/32"	8-13/32"
F	2-8/9"	2-8/9"	3-1/16"	2-13/32"	3-1/8"

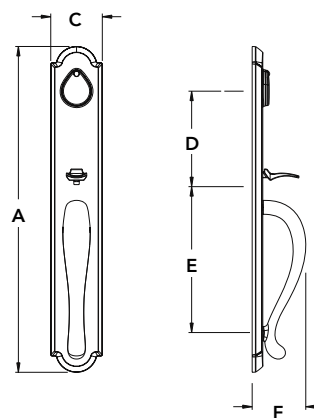

FULL ESCUTCHEON			
	SAN	ELK	LON
A	17-1/2"	18-3/4"	18-1/2"
B	N/A	N/A	N/A
C	2-11/16"	2-15/16"	2-15/16"
D	5-1/2"	5-1/2"	5-1/2"
E	8-13/32"	8-13/32"	8-13/32"
F	2-13/32"	3-1/16"	3-1/8"

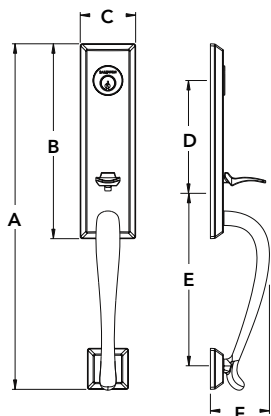

¾ ESCUTCHEON				
	DEL	CHE	NEW	ELI
A	16-13/16"	18-1/4"	17-5/8"	18-11/16"
B	9-1/2"	10-13/16"	10-5/16"	10-5/16"
C	2-11/16"	3-1/8"	2-11/16"	2-11/16"
D	5-1/2"	5-1/2"	5-1/2"	5-1/2"
E	8-13/32"	8-13/32"	8-13/32"	8-13/32"
F	2-8/9"	2-8/9"	3-1/16"	3-5/16"

¾ ESCUTCHEON			
	MIA	SEA	KOD
A	18-1/16"	17-1/2"	18-1/2"
B	9-7/8"	9-1/2"	10-9/16"
C	2-11/16"	2-11/16"	2-15/16"
D	5-1/2"	5-1/2"	5-1/2"
E	8-13/32"	8-13/32"	8-13/32"
F	3"	2-7/16"	3-1/16"

HANDLESET SPECIFICATIONS

Door Preparation	2-1/8" Cross Bore for both deadbolt and grip. 1" edge bore for both grip latch and deadbolt latch. 5-1/2" center to center tubular bore.
Door Thickness	Up to 2-1/2" doors optional through Thick Door Service Part Kit. Napa and Westcliff styles only: 1-3/8" to 1-3/4" thin door service part kit available.
Cylinder	Baldwin C-Keyway standard. SmartKey® Re-key Technology optional.
Backset	Adjustable 2-3/8" or 2-3/4"
Front & Latch	6 Way Adjustable (6L).
Strike	Dual Strike (DS). Extended Lip strike shipped with all thick door locks (ES).
Latch Bolt	Deadbolt features 1" throw Brass bolt latch. Grip offers 1/2" passage/privacy function bolt.
Knob/Lever Rotation	Knob/Lever rotate at 55°- 60°.
Handing	Handing only required when ordering lever interior style.
ANSI/BHMA	Deadbolt tested to exceed ANSI/BHMA Grade 2 security.
ADA	N/A
UL	20-minute certified UL kit available.

DIMENSIONS & SPECIFICATIONS - EGRESS HANDLESETS

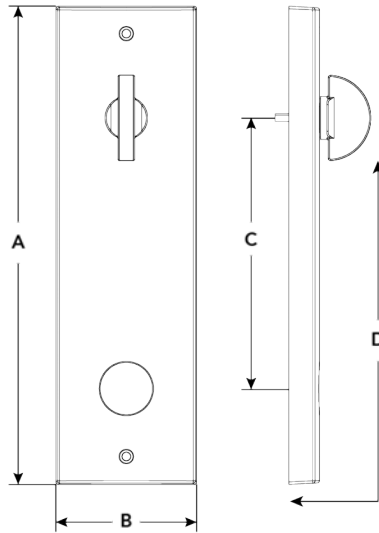

EGRESS INTERIOR ESCUTCHEON/TRIMS SPECIFICATIONS

	EBE	SBE	TAE	CQE	RAE
A	10-1/2"	9-19/32"	10-13/32"	9-1/2"	10-19/32"
B	2-15/16"	2-7/8"	2-7/8"	2-13/16"	2-31/32"
C	5-3/8"	5-3/8"	5-3/8"	5-3/8"	5-3/8"
D	1-5/8"	1-5/8"	1-5/8"	1-5/8"	1-5/8"

EGRESS HANDLESET INTERIOR SPECIFICATION

Door Preparation	2-1/8" Cross Bore for both deadbolt and grip. 1" edge bore for both grip latch and deadbolt latch. 5-1/2" center to center tubular bore.
Door Thickness	1-3/4" to 2" standard. Up to 2-1/2" doors optional through Thick Door Service Part Kit.
Cylinder	Baldwin C-Keyway standard. SmartKey® Re-key Technology optional.
Backset	Adjustable 2-3/8" or 2-3/4"
Front & Latch	6 Way Adjustable (6L).
Strike	Dual Strike (DS). Extended Lip strike shipped with all thick door locks (ES).
Latch Bolt	Deadbolt features 1" throw Brass bolt latch. Grip offers 1/2" passage/privacy function bolt.
Knob/Lever Rotation	Knob/Lever rotate at 55°- 60°.
Handing	Handing only required when ordering lever interior style.
ANSI/BHMA	Deadbolt tested to exceed ANSI/BHMA Grade 2 security.
ADA	N/A
UL	20-minute certified UL kit available.

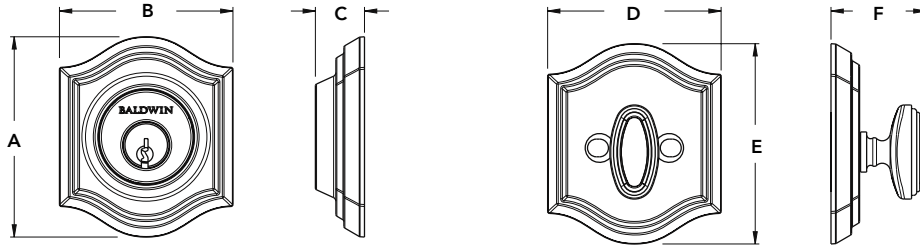

DEADBOLT							
	TRD	TSD	TAD	CRD	CSD	RAD	RSD
A	Ø 2-3/5"	2-3/5"	3-1/16"	Ø 2-5/8"	2-9/16"	3-5/8"	3-1/8"
B	N/A	2-3/5"	2-11/16"	N/A	2-9/16"	2-11/16"	2-9/16"
C	¾"	¾"	¾"	¾"	¾"	1-1/16"	1-1/16"
D	Ø 2-5/8"	2-5/8"	2-11/16"	Ø 2-5/8"	2-5/8"	2-11/16"	2-5/8"
E	N/A	2-5/8"	3-1/16"	N/A	2-5/8"	3-7/16"	2-5/8"
F (SC)	1-7/16"	1-7/16"	1-7/16"	1-7/16"	1-7/16"	1-7/16"	1-7/16"
F (DC)	¾"	¾"	¾"	¾"	¾"	1-1/16"	1-1/16"

DEADBOLT SPECIFICATIONS

Door Preparation	Deadbolt: 2-1/8" Cross Bore. 1" edge bore for latch. Patio: 1-7/8" counterbore. 1" edge bore for latch.
Door Thickness	1-3/4" to 2" standard. Up to 2-1/2" doors optional through Thick Door Service Part Kit. Traditional & Contemporary styles: 1-3/8" to 1-3/4" doors available through Thin Door Service Part Kit. Thin door option not available with rustic deadbolt styles.
Cylinder	Baldwin C-Key standard. SmartKey® Re-Key Technology optional.
Backset	Adjustable 2-3/8" or 2-3/4"
Front & Latch	6 Way Adjustable (6L).
Strike	Dual Strike (DS), or Full Lip Strike (FS) optional.
Latch Bolt	Deadbolt features 1" throw Brass bolt latch.
Handing	Handing not required.
ANSI/BHMA	Tested to exceed ANSI/BHMA Grade 2 security.
ADA	N/A
UL	20-minute certified UL kit available.

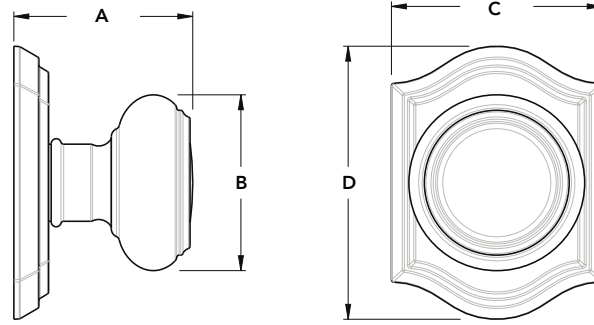

KNOBS							
	CRY	ELI	ROU	TRA	CON	CCY	RUS
A	2-29/32"	2-11/32"	2-7/32"	2-1/4"	2-5/32"	2-11/16"	2-7/32"
A (Keyed)	N/A	2-3/16"	2-3/16"	2-3/16"	2-3/16"	N/A	2-3/16"
B	2-3/16"	2-7/16"	Ø 2-3/16"	2-7/32"	2-11/32"	2-11/32"	2-11/32"

ROSES								
	TRR	TAR	TSR	CFR	CRR	CSR	RAR	RSR
C	2-9/16"	2-21/32"	2-19/32"	2-9/16"	2-9/16"	2-9/16"	2-11/16"	2-5/8"
D	2-9/16"	3-7/16"	2-19/32"	5"	2-9/16"	2-9/16"	4-1/2"	4"

KNOB SPECIFICATIONS	
Door Preparation	2-1/8" Cross Bore. 1" edge bore for latch.
Installation Type	Entry, Privacy, Passage and Full Dummy: Full Bore required, interior has exposed screws. Half Dummy: Surface mounted, exposed screws.
Door Thickness	1-3/8" to 2" standard. 2" to 2-1/2" doors optional through Thick Door Service Part Kit.
Cylinder	Baldwin 5-pin C-Keyway.
Backset	Adjustable 2-3/8" or 2-3/4"
Front & Latch	6 Way Adjustable (6L).
Strike	Dual Strike (DS). Extended Lip strike shipped with all thick door locks (ES).
Latch Bolt	1/2" passage/privacy/entry function bolt.
Knob/Lever Rotation	Knob/Lever rotate at 55° - 60°.
Handing	Handing not required.
ANSI/BHMA	Tested to exceed ANSI/BHMA Grade 2 security.
ADA	N/A
UL	20-minute certified UL kit available.

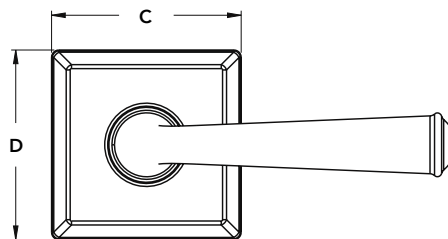
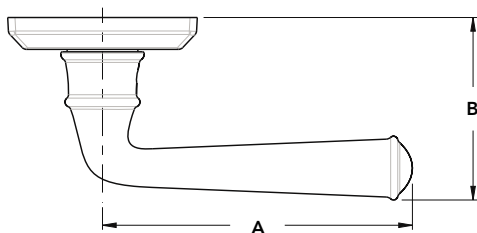

LEVERS							
	ARC	CUR	DEC	FED	SQU	TAP	TUB
A	4-1/2"	3-31/32"	4-1/4"	4-1/4"	4-1/4"	4-1/4"	4-1/4"
B	2-9/16"	2-17/32"	2-3/4"	2-1/2"	2-3/8"	2-7/16"	2-9/32"
B (Keyed)	2-3/8"	2-13/32"	2-9/16"	2-9/16"	2-3/16"	2-1/4"	2-3/16"

ROSES								
	TRR	TAR	TSR	CFR	CRR	CSR	RAR	RSR
C	2-9/16"	2-21/32"	2-19/32"	2-9/16"	2-9/16"	2-9/16"	2-11/16"	2-5/8"
D	2-9/16"	3-7/16"	2-19/32"	5"	2-9/16"	2-9/16"	4-1/2"	4"

LEVER SPECIFICATIONS	
Door Preparation	2-1/8" Cross Bore. 1" edge bore for latch.
Installation Type	Entry, Privacy, Passage and Full Dummy: Full Bore required, interior has exposed screws. Half Dummy: Surface mounted, exposed screws.
Door Thickness	1-3/8" to 2" standard. 2" to 2-1/2" doors optional through Thick Door Service Part Kit.
Cylinder	Baldwin 5-pin C-Keyway.
Backset	Adjustable 2-3/8" or 2-3/4"
Front & Latch	6 Way Adjustable (6L).
Strike	Dual Strike (DS). Extended Lip strike shipped with all thick door locks (ES).
Latch Bolt	1/2" passage/privacy/entry function bolt.
Knob/Lever Rotation	Knob/Lever rotate at 55° - 60°.
Handing	With exception to half dummy function, all levers are reversible for right or left hand doors.
ANSI/BHMA	Tested to exceed ANSI/BHMA Grade 2 security.
ADA	Passage (BR352) products meet ADA requirements.
UL	20-minute certified UL kit available.

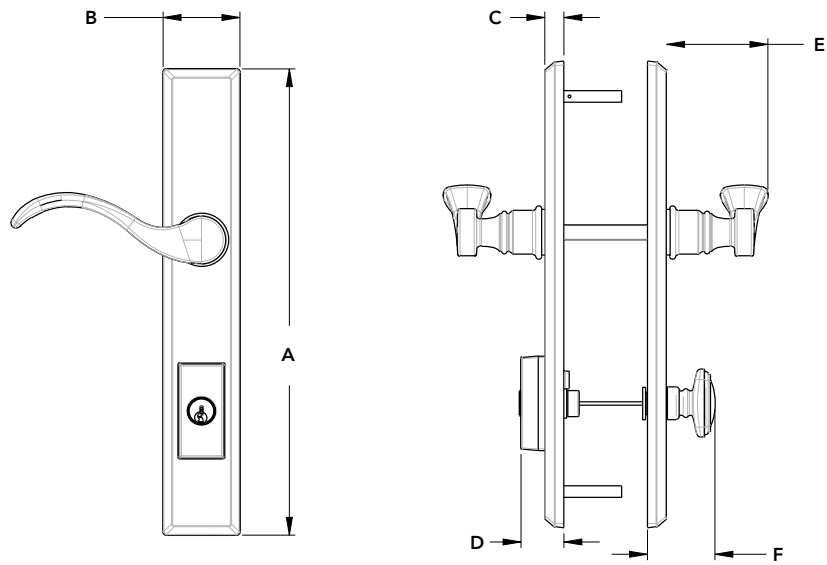

MULTIPOINT					
	DEL	CHE	SEA	LON	ELK
A	9-7/8"	9-7/8"	9-57/64"	9-7/8"	10-11/32"
B	1-39/64"	2"	1-17/32"	1-39/64"	1-39/64"
C	13/32"	13/32"	13/32"	13/32"	13/32"
D (AM)	29/32"	29/32"	29/32"	29/32"	29/32"
D (PR)	9/16"	9/16"	9/16"	9/16"	9/16"
E	2-1/8"	2-3/32"	1-59/64"	2-1/32"	2-5/32"
F	1-13/32"	1-13/32"	1-13/32"	1-13/32"	1-13/32"

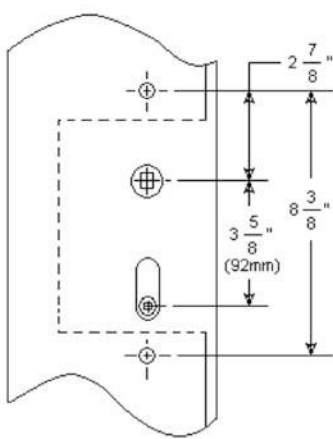

Configuration 3

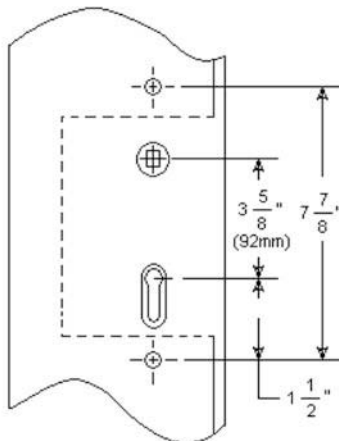

Configuration 4

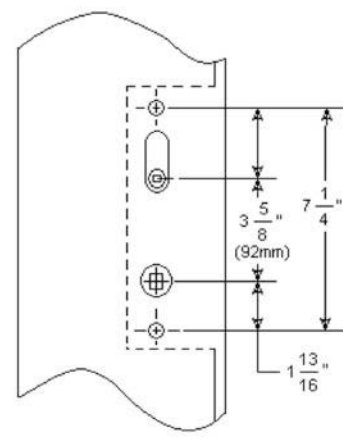

Configuration 6

MULTIPOINT CYLINDERS - ENTRY & PATIO

Core Part No.	Item	FINISHES										Qty.	List Price
		003	112	150	152	260	481	492	055	190	044		
8BR0226-xxx	Entry - Profile Traditional Cylinder, 2 Keys on a Ring	-001	-003	-004	-005	-006			-007	-008	-011	1	\$60.0
8BR0227-xxx	Patio - Profile Traditional Cylinder, 2 Keys on a Ring	-001	-003	-004	-005	-006			-007	-008	-011	1	\$48.00
8BR0228-xxx	Entry - Profile Contemporary Cylinder, 2 Keys on a Ring		-001	-002		-003			-004	-005	-011	1	\$60.00
8BR0229-xxx	Patio - Profile Contemporary Cylinder, 2 Keys on a Ring		-001	-002		-003			-004	-005	-011	1	\$48.00
8BR0230-xxx	Entry - Profile Rustic Cylinder, 2 Keys on a Ring						-001	-002				1	\$60.00
8BR0231-xxx	Patio - Profile Rustic Cylinder, 2 Keys on a Ring						-001	-002				1	\$48.00

MULTIPOINT CYLINDERS - AMERICAN

Core Part No.	Item	FINISHES			Qty.	List Price
		Gold	Silver	Bronze		
8BR0224-xxx	C-Key, American CYL, 2 Keys on a Ring	-001	-002	-003	1	\$30.00

MULTIPOINT GASKETS

Part No.	Item	Qty.	List Price
8BR0653-001	Del Mar/ Longview Multipoint Entry Gasket, Config #3-4-6	1	\$8.00
8BR0654-001	Seattle Multipoint Entry Gasket, Config #3-4-6	1	\$8.00
8BR0655-001	Elkhorn Multipoint Entry Gasket, Config #3-4-6	1	\$8.00
8BR0656-001	Chesapeake Multipoint Entry Gasket, Config #3-4-6	1	\$8.00
8BR0657-001	Del Mar/ Longview Multipoint Patio/ Dummy Gasket, Config #3-4-6	1	\$8.00
8BR0658-001	Seattle Multipoint Patio/ Dummy Gasket, Config #3-4-6	1	\$8.00
8BR0659-001	Elkhorn Multipoint Patio/ Dummy Gasket, Config #3-4-6	1	\$8.00
8BR0660-001	Chesapeake Multipoint Patio/ Dummy Gasket, Config #3-4-6	1	\$8.00

MULTIPOINT SCREWPACKS

Core Part No.	Item	FINISHES										Qty.	List Price
		003	112	150	152	260	481	492	055	190	044		
8BR0523-xxx	Multipoint Mounting Screws	-001	-003	-004	-005	-006	-007	-008	-007	-010	-011	1	\$5.00

MISC PARTS

Core Part No.	Item	FINISHES										Qty.	List Price
		003	112	150	152	260	481	492	055	190	044		
8BR0649-001	Spring Asst. Cartridge w. Screws	N/A	N/A	N/A	N/A	N/A	N/A	N/A	N/A	N/A	N/A	1	\$15.00
8BR0661-001	Multipoint Spindle, 1-3/8 to 2-1/4" Thick Doors	N/A	N/A	N/A	N/A	N/A	N/A	N/A	N/A	N/A	N/A	1	\$6.00
8BR0662-001	Multipoint Spindle, 2" to 2-1/4" Thick Doors	N/A	N/A	N/A	N/A	N/A	N/A	N/A	N/A	N/A	N/A	1	\$6.00

KEY BLANKS

Part No.	Item	Qty.	List Price
8BR0100-007	C-Keyway, Baldwin Bow	10	\$32.00
8BR0100-008	SmartKey, Baldwin Bow	10	\$32.00

CUT KEYS - RANDOM CUT

Part No.	Item	Qty.	List Price
8BR0100-001	C-Keyway, 2 Keys on a Ring	1 set	\$6.00
8BR0100-002	C-Keyway, 4 Keys on a Ring	1 set	\$11.00
8BR0100-004	SmartKey with Learn Tool, 2 Keys on a Ring	1 set	\$6.00
8BR0100-005	SmartKey with Learn Tool, 4 Keys on a Ring	1 set	\$11.00

CUT KEYS – KEY CODE *(Keys cut to specific cut)*

Part No.	Item	Qty.	List Price
8BR0100-003	C-Keyway, 2 Keys on a Ring	1 set	\$7.00
8BR0100-006	SmartKey with Learn Tool, 2 Keys on a Ring	1 set	\$7.00

CYLINDERS – SINGLE CYLINDER DEADBOLT Includes Cylinder Assembly With Housing

Core Part No.	Item	FINISHES										Qty.	List Price
		003	112	150	152	260	481	492	055	190	044		
8BR0201-xxx	C-Keyway, 2 Keys on a Ring	-001	-003	-004	-005	-006	-007	-008	-009	-010	-011	1	\$22.00
8BR0206-xxx	C-Keyway, 4 Keys on a Ring	-001	-003	-004	-005	-006	-007	-008	-009	-010	-011	1	\$27.00
8BR0211-xxx	C-Keyway, KC – Key Code 2 Keys	-001	-003	-004	-005	-006	-007	-008	-009	-010	-011	1	\$22.00
8BR0204-xxx	SmartKey 2 Keys on a Ring	-001	-003	-004	-005	-006	-007	-008	-009	-010	-011	1	\$22.00
8BR0209-xxx	SmartKey 4 Keys on a Ring	-001	-003	-004	-005	-006	-007	-008	-009	-010	-011	1	\$29.00
8BR0214-xxx	SmartKey KC – Key Code 2 Keys	-001	-003	-004	-005	-006	-007	-008	-009	-010	-011	1	\$23.00

TO ORDER: COMBINE PART NO. AND FINISH SUFFIX EX: 8BR0201-XXX AND -001 = 8BR0201-001

CYLINDERS – DOUBLE CYLINDER DEADBOLT Includes Cylinder Assembly With Housing

Core Part No.	Item	FINISHES										Qty.	List Price
		003	112	150	152	260	481	492	055	190	044		
8BR0202-xxx	C-Keyway, 2 Keys on a Ring	-001	-003	-004	-005	-006	-007	-008	-009	-010	-011	1	\$46.00
8BR0207-xxx	C-Keyway, 4 Keys on a Ring	-001	-003	-004	-005	-006	-007	-008	-009	-010	-011	1	\$51.00
8BR0212-xxx	C-Keyway, KC – Key Code 2 Keys	-001	-003	-004	-005	-006	-007	-008	-009	-010	-011	1	\$47.00
8BR0205-xxx	SmartKey 2 Keys on a Ring	-001	-003	-004	-005	-006	-007	-008	-009	-010	-011	1	\$43.00
8BR0210-xxx	SmartKey 4 Keys on a Ring	-001	-003	-004	-005	-006	-007	-008	-009	-010	-011	1	\$48.00
8BR0215-xxx	SmartKey KC – Key Code 2 Keys	-001	-003	-004	-005	-006	-007	-008	-009	-010	-011	1	\$44.00

CYLINDERS – KNOB AND LEVER Includes Cylinder Assembly With Housing

Core Part No.	Item	FINISHES			Qty.	List Price
		Gold	Silver	Bronze		
8BR0203-xxx	C-Keyway, 2 Keys on a Ring	-001	-002	-003	1	\$18.00
8BR0208-xxx	C-Keyway, 4 Keys on a Ring	-001	-002	-003	1	\$22.00
8BR0213-xxx	C-Keyway, KC – Key Code 2 Keys	-001	-002	-003	1	\$19.00

CYLINDER PLUGS

Core Part No.	Item	FINISHES			Qty.	List Price
		Gold	Silver	Bronze		
8BR0615-xxx	Deadbolt Cylinder Plug, C-Keyway	-001	-002	-003	1	\$5.00
8BR0616-xxx	Knob/Lever Cylinder Plug, C-Keyway	-001	-002	-003	1	\$5.00

BUILDING A SERVICE PART NUMBER

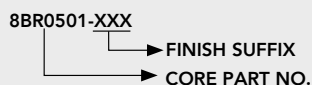

To create service part # combine core and function suffix.
 Example: **8BR0501-001**
 For Single Cylinder screwpack in polished brass (Standard door thickness).

TO ORDER: COMBINE PART NO. AND FINISH SUFFIX EX: 8BR0615-XXX AND -002 = 8BR0615-022

LATCHES

Part No./Core No.	Item	FINISHES											Qty.	List Price
		003	112	150	152	260	481	492	055	190	044			
8BR0301-001	Deadlatch, core latch for Entry (EN) lever/knob	N/A	N/A	N/A	N/A	N/A	N/A	N/A	N/A	N/A	N/A	N/A	1	\$12.00
8BR0302-001	Plainlatch, for Handleset (SC/DC) and Knob/Lever (PS/PV)	N/A	N/A	N/A	N/A	N/A	N/A	N/A	N/A	N/A	N/A	N/A	1	\$11.00
8BR0303-001	Deadbolt, core latch with backplate for Handleset (SC/DC) and deadbolt (SC / DC)	N/A	N/A	N/A	N/A	N/A	N/A	N/A	N/A	N/A	N/A	N/A	1	\$19.00
8BR0304-xxx	Deadlatch, 6L for Entry (EN) lever/knob	-001	-003	-004	-005	-006	-007	-008	-009	-010	-011	1	\$23.00	
8BR0305-xxx	Plainlatch, 6L for Handleset (SC/DC) and Knob/Lever (PS/PV)	-001	-003	-004	-005	-006	-007	-008	-009	-010	-011	1	\$22.00	
8BR0306-xxx	Deadbolt, 6L for Handleset (SC/DC) and deadbolt (SC/DC)	-001	-003	-004	-005	-006	-007	-008	-009	-010	-011	1	\$30.00	
8BR0307-xxx	Deadlatch, SL UL for Entry (EN) lever/knob	-001	-003	-004	-005	-006	-007	-008	-009	-010	-011	1	\$23.00	
8BR0308-xxx	Deadlatch, RL UL for Entry (EN) lever/knob	-001	-003	-004	-005	-006	-007	-008	-009	-010	-011	1	\$23.00	
8BR0309-001	Deadlatch, DL UL for Entry (EN) lever/knob	N/A	N/A	N/A	N/A	N/A	N/A	N/A	N/A	N/A	N/A	1	\$23.00	
8BR0310-xxx	Plainlatch, SL UL for Handleset (SC/DC) and Knob/Lever (PS/PV)	-001	-003	-004	-005	-006	-007	-008	-009	-010	-011	1	\$22.00	
8BR0311-xxx	Plainlatch, RL UL for Handleset (SC/DC) and Knob/Lever (PS/PV)	-001	-003	-004	-005	-006	-007	-008	-009	-010	-011	1	\$22.00	
8BR0312-001	Plainlatch, DL UL for Handleset (SC/DC) and Knob/Lever (PS/PV)	N/A	N/A	N/A	N/A	N/A	N/A	N/A	N/A	N/A	N/A	1	\$22.00	
8BR0313-xxx	Deadbolt, SL UL for Handleset (SC/DC) and deadbolt (SC/DC)	-001	-003	-004	-005	-006	-007	-008	-009	-010	-011	1	\$30.00	
8BR0314-xxx	Deadbolt, RL UL Deadbolt, SL UL for Handleset (SC/DC) and deadbolt (SC/DC)	-001	-003	-004	-005	-006	-007	-008	-009	-010	-011	1	\$30.00	
8BR0315-001	Deadbolt, DL UL Deadbolt, SL UL for Handleset (SC/DC) and deadbolt (SC/DC)	N/A	N/A	N/A	N/A	N/A	N/A	N/A	N/A	N/A	N/A	1	\$30.00	
8BR0316-xxx	Deadbolt, SL Front with screws for Handleset (SC/DC) and deadbolt (SC/DC)	-001	-003	-004	-005	-006	-007	-008	-009	-010	-011	1	\$6.00	
8BR0317-xxx	Deadbolt, RC Front with screws for Handleset (SC/DC) and deadbolt (SC/DC)	-001	-003	-004	-005	-006	-007	-008	-009	-010	-011	1	\$6.00	
8BR0318-001	Deadbolt, DL Collar for Handleset (SC/DC) and deadbolt (SC/DC)	N/A	N/A	N/A	N/A	N/A	N/A	N/A	N/A	N/A	N/A	1	\$6.00	
8BR0320-xxx	Plainlatch, SL Front with screws for Handleset (SC/DC) and Knob/Lever (PS/PV)	-001	-003	-004	-005	-006	-007	-008	-009	-010	-011	1	\$6.00	
8BR0321-xxx	Plainlatch, RC Front with screws for Handleset (SC/DC) and Knob/Lever (PS/PV)	-001	-003	-004	-005	-006	-007	-008	-009	-010	-011	1	\$6.00	
8BR0322-001	Plainlatch, DL Collar for Handleset (SC/DC) and Knob/Lever (PS/PV)	N/A	N/A	N/A	N/A	N/A	N/A	N/A	N/A	N/A	N/A	1	\$6.00	
8BR0324-xxx	Deadlatch, SL Front with screws for Entry (EN) lever/knob	-001	-003	-004	-005	-006	-007	-008	-009	-010	-011	1	\$6.00	
8BR0325-xxx	Deadlatch, RC Front with screws for Entry (EN) lever/knob	-001	-003	-004	-005	-006	-007	-008	-009	-010	-011	1	\$6.00	
8BR0326-001	Deadlatch, DL Collar for Entry (EN) lever/knob	N/A	N/A	N/A	N/A	N/A	N/A	N/A	N/A	N/A	N/A	1	\$6.00	
8BR0328-001	Plainlatch/Deadlatch Backplate	N/A	N/A	N/A	N/A	N/A	N/A	N/A	N/A	N/A	N/A	1	\$5.00	
8BR0329-001	Deadbolt Backplate for Handleset (SC/DC) and deadbolt (SC/DC)	N/A	N/A	N/A	N/A	N/A	N/A	N/A	N/A	N/A	N/A	1	\$5.00	

TO ORDER: COMBINE PART NO. AND FINISH SUFFIX EX: 8BR0320-XXX AND -001 = 8BR0320-001

STRIKES

Part No./Core No.	Item	FINISHES										Qty.	List Price
		003	112	150	152	260	481	492	055	190	044		
8BR0401-xxx	Dual Strike Kit, Knob/Lever	-001	-003	-004	-005	-006	-007	-008	-009	-010	-011	1	\$7.00
8BR0402-xxx	Dual Strike Kit, Deadbolt	-001	-003	-004	-005	-006	-007	-008	-009	-010	-011	1	\$7.00
8BR0403-xxx	Square Corner, Knob/Lever	-001	-003	-004	-005	-006	-007	-008	-009	-010	-011	1	\$3.00
8BR0404-xxx	Round Corner, Knob/Lever	-001	-003	-004	-005	-006	-007	-008	-009	-010	-011	1	\$3.00
8BR0405-xxx	Square Corner, Deadbolt	-001	-003	-004	-005	-006	-007	-008	-009	-010	-011	1	\$3.00
8BR0406-xxx	Round Corner, Deadbolt	-001	-003	-004	-005	-006	-007	-008	-009	-010	-011	1	\$3.00
8BR0407-xxx	Full Lip, Deadbolt	-001	-003	-004	-005	-006	-007	-008	-009	-010	-011	1	\$3.00
8BR0408-xxx	Extended Lip, Knob/Lever	-001	-003	-004	-005	-006	-007	-008	-009	-010	-011	1	\$3.00
8BR0409-001	Knob/Lever Dust Box	N/A	N/A	N/A	N/A	N/A	N/A	N/A	N/A	N/A	N/A	1	\$2.00

SCREWPACKS

Part No./Core No.	Item	FINISHES										Qty.	List Price
		003	112	150	152	260	481	492	055	190	044		
8BR0516-xxx	Single Cylinder Deadbolt, 1.375" to 1.75"	-001	-003	-004	-005	-006	-007	-008	-009	-010	-011	1	\$2.00
8BR0501-xxx	Single Cylinder Deadbolt, 1.75" to 2"	-001	-003	-004	-005	-006	-007	-008	-009	-010	-011	1	\$2.00
8BR0502-xxx	Single Cylinder Deadbolt, 2" to 2.5"	-001	-003	-004	-005	-006	-007	-008	-009	-010	-011	1	\$2.00
8BR0503-001	Double Cylinder Deadbolt, 1.75" to 2"	N/A	N/A	N/A	N/A	N/A	N/A	N/A	N/A	N/A	N/A	1	\$2.00
8BR0504-001	Double Cylinder Deadbolt, 2" to 2.5"	N/A	N/A	N/A	N/A	N/A	N/A	N/A	N/A	N/A	N/A	1	\$2.00
8BR0505-xxx	Double Cylinder Deadbolt, Interior Finished Screws	-001	-003	-004	-005	-006	-007	-008	-009	-010	-011	1	\$2.00
8BR0514-xxx	Patio Deadbolt, 1.375" to 2"	-001	-003	-004	-005	-006	-007	-008	-009	-010	-011	1	\$2.00
8BR0515-xxx	Patio Deadbolt, 2" to 2.5"	-001	-003	-004	-005	-006	-007	-008	-009	-010	-011	1	\$2.00
8BR0517-xxx	Handleset Knob/Lever, 1.375" to 1.75"	-001	-003	-004	-005	-006	-007	-008	-009	-010	-011	1	\$2.00
8BR0518-001	Handleset Thrubolt, 1.375" to 1.75"	N/A	N/A	N/A	N/A	N/A	N/A	N/A	N/A	N/A	N/A	1	\$2.00
8BR0506-xxx	Knob/Lever, 1.375" to 2"	-001	-003	-004	-005	-006	-007	-008	-009	-010	-011	1	\$2.00
8BR0512-xxx	Knob/Lever, 2" to 2.5"	-001	-003	-004	-005	-006	-007	-008	-009	-010	-011	1	\$2.00
8BR0507-xxx	Knob/Lever, Half Dummy	-001	-003	-004	-005	-006	-007	-008	-009	-010	-011	1	\$2.00
8BR0508-xxx	Latch Front Screws	-001	-003	-004	-005	-006	-007	-008	-009	-010	-011	1	\$2.00
8BR0509-001	*Entry Knob Set Screw Kit	N/A	N/A	N/A	N/A	N/A	N/A	N/A	N/A	N/A	N/A	1	\$5.00
8BR0510-001	*Entry Lever Set Screw Kit	N/A	N/A	N/A	N/A	N/A	N/A	N/A	N/A	N/A	N/A	1	\$5.00
8BR0511-001	*PV/PS/FD/HD Set Screw Kit	N/A	N/A	N/A	N/A	N/A	N/A	N/A	N/A	N/A	N/A	1	\$5.00
8BR0524-xxx	Egress Escutcheon Trim Screws	-001	-003	-004	-005	-006	-007	-008	-009	-010	-011	1	\$2.00
8BR0525-001	Egress Cartridge Screws	N/A	N/A	N/A	N/A	N/A	N/A	N/A	N/A	N/A	N/A	1	\$2.00
8BR0526-001	Egress Thick Door Screws	N/A	N/A	N/A	N/A	N/A	N/A	N/A	N/A	N/A	N/A	1	\$2.00
8BR0527-001	Egress Cartridge Dummy Screws	N/A	N/A	N/A	N/A	N/A	N/A	N/A	N/A	N/A	N/A	1	\$2.00

*Setscrewkitcontainstwosetscrews(exteriorandinterior)

TO ORDER: COMBINE PART NO. AND FINISH SUFFIX EX: 8BR0501-XXX AND -001 = 8BR0501-001

MISC. PARTS

Part No./ Core No.	Item	FINISHES										PKG Qty.	List Price	
		003	112	150	152	260	481	492	055	190	044			
8BR0601-001	Half Round PS/PV Spindle, 1.375" up to 2"*	N/A	N/A	N/A	N/A	N/A	N/A	N/A	N/A	N/A	N/A	N/A	1	\$2.00
8BR0602-001	Half Round PS/PV Spindle, 2" up to 2.5"*	N/A	N/A	N/A	N/A	N/A	N/A	N/A	N/A	N/A	N/A	N/A	1	\$2.00
8BR0637-001	Half Round PV Spindle, 1.375" up to 2"***	N/A	N/A	N/A	N/A	N/A	N/A	N/A	N/A	N/A	N/A	N/A	1	\$2.00
8BR0638-001	Half Round PV Spindle, 2" up to 2.5"***	N/A	N/A	N/A	N/A	N/A	N/A	N/A	N/A	N/A	N/A	N/A	1	\$2.00
8BR0603-xxx	Decorative Handleset Cap	-001	-003	-004	-005	-006	-007	-008	-009	-010	-011	1	\$3.00	
8BR0632-001	Single Cylinder Deadbolt Torque Blade, 1.375" to 1.75"	N/A	N/A	N/A	N/A	N/A	N/A	N/A	N/A	N/A	N/A	1	\$2.00	
8BR0604-001	Single Cylinder Deadbolt Torque Blade, 1.75" up to 2"	N/A	N/A	N/A	N/A	N/A	N/A	N/A	N/A	N/A	N/A	1	\$2.00	
8BR0605-001	Single Cylinder Deadbolt Torque Blade, 2" up to 2.5"	N/A	N/A	N/A	N/A	N/A	N/A	N/A	N/A	N/A	N/A	1	\$2.00	
8BR0633-001	Double Cylinder Deadbolt Torque Blade, Exterior, 1.375" up to 1.75"	N/A	N/A	N/A	N/A	N/A	N/A	N/A	N/A	N/A	N/A	1	\$2.00	
8BR0634-001	Double Cylinder Deadbolt Torque Blade, Interior, 1.375" up to 1.75"	N/A	N/A	N/A	N/A	N/A	N/A	N/A	N/A	N/A	N/A	1	\$2.00	
8BR0606-001	Double Cylinder Deadbolt Torque Blade, 1.75" up to 2"	N/A	N/A	N/A	N/A	N/A	N/A	N/A	N/A	N/A	N/A	1	\$2.00	
8BR0607-001	Double Cylinder Deadbolt Torque Blade, 2" up to 2.5"	N/A	N/A	N/A	N/A	N/A	N/A	N/A	N/A	N/A	N/A	1	\$2.00	
8BR0608-001	Double Cylinder Deadbolt Interior Torque Blade	N/A	N/A	N/A	N/A	N/A	N/A	N/A	N/A	N/A	N/A	1	\$2.00	
8BR0630-001	Patio Deadbolt Torque Blade, 1.375" up to 2"	N/A	N/A	N/A	N/A	N/A	N/A	N/A	N/A	N/A	N/A	1	\$2.00	
8BR0631-001	Patio Deadbolt Torque Blade, 2" up to 2.5"	N/A	N/A	N/A	N/A	N/A	N/A	N/A	N/A	N/A	N/A	1	\$2.00	
8BR0609-001	Deadbolt C-Keyway Cylinder Clip (Bag of 50)***	N/A	N/A	N/A	N/A	N/A	N/A	N/A	N/A	N/A	N/A	50	\$36.00	
8BR0610-001	Deadbolt SmartKey Cylinder Clip (Bag of 50)***	N/A	N/A	N/A	N/A	N/A	N/A	N/A	N/A	N/A	N/A	50	\$36.00	
8BR0611-001	Knob/Lever C-Keyway Cylinder Clip (Bag of 50)***	N/A	N/A	N/A	N/A	N/A	N/A	N/A	N/A	N/A	N/A	50	\$36.00	
8BR0612-001	3/32" Hex Wrench	N/A	N/A	N/A	N/A	N/A	N/A	N/A	N/A	N/A	N/A	1	\$1.00	
8BR0613-001	Emergency Release Tool	N/A	N/A	N/A	N/A	N/A	N/A	N/A	N/A	N/A	N/A	1	\$2.00	
8BR0614-001	Finish Gauge	N/A	N/A	N/A	N/A	N/A	N/A	N/A	N/A	N/A	N/A	1	\$32.00	
8BR0617-001	Cylinder Removal Tool	N/A	N/A	N/A	N/A	N/A	N/A	N/A	N/A	N/A	N/A	1	\$2.00	
8BR0618-001	Deadbolt spacer	N/A	N/A	N/A	N/A	N/A	N/A	N/A	N/A	N/A	N/A	1	\$2.00	
8BR0636-001	HS/DB Thin Door Spacer, 1.375" to 1.75"	N/A	N/A	N/A	N/A	N/A	N/A	N/A	N/A	N/A	N/A	1	\$2.00	
8BR0620-001	SmartKey Reset Cradle	N/A	N/A	N/A	N/A	N/A	N/A	N/A	N/A	N/A	N/A	1	\$51.00	
8BR0622-xxx	Handleset, Deadbolt Cylinder Cap, Exterior, C-Keyway	-001	-003	-004	-005	-006	-007	-008	-009	-010	-011	1	\$8.00	
8BR0623-xxx	Handleset, Deadbolt Cylinder Cap, Exterior, SmartKey	-001	-003	-004	-005	-006	-007	-008	-009	-010	-011	1	\$8.00	
8BR0624-xxx	Handleset, Deadbolt Cylinder Cap, Interior, C-Keyway	-001	-003	-004	-005	-006	-007	-008	-009	-010	-011	1	\$8.00	
8BR0625-xxx	Handleset, Deadbolt Cylinder Cap, Interior, SmartKey	-001	-003	-004	-005	-006	-007	-008	-009	-010	-011	1	\$8.00	
8BR0626-xxx	Deadbolt Cylinder Cap, Dummy	-001	-003	-004	-005	-006	-007	-008	-009	-010	-011	1	\$8.00	
8BR0635-001	Patio Deadbolt Adapter	N/A	N/A	N/A	N/A	N/A	N/A	N/A	N/A	N/A	N/A	1	\$15.00	
8BR0629-001	Cylinder Plug Follower	N/A	N/A	N/A	N/A	N/A	N/A	N/A	N/A	N/A	N/A	1	\$5.00	
8BR0665-001	Thumb Piece Spring Cartridge	N/A	N/A	N/A	N/A	N/A	N/A	N/A	N/A	N/A	N/A	1	\$10.00	
8BR0666-001	Egress Interconnect Cartridge Lever Strength	N/A	N/A	N/A	N/A	N/A	N/A	N/A	N/A	N/A	N/A	1	\$18.00	
8BR0667-001	Egress Interconnect Cartridge Knob Strength	N/A	N/A	N/A	N/A	N/A	N/A	N/A	N/A	N/A	N/A	1	\$18.00	

*Needed for PV knobs and levers manufactured prior to April 2016.

**Needed for PV knobs and levers manufactured after April 2016.

***Order a unit quantity of one (1) to receive 50 cylinder clips.

TO ORDER: COMBINE PART NO. AND FINISH SUFFIX EX: 8BR0603-XXX AND -001 = 8BR0603-001

THICK DOOR KITS

Core Part No.	Item	FINISHES										Qty.	List Price
		003	112	150	152	260	481	492	055	190	044		
8BR0701-xxx	Single Cylinder Handleset	-001	-003	-004	-005	-006	-007	-008	-009	-010	-011	1	\$18.00
8BR0702-xxx	Double Cylinder Handleset	-001	-003	-004	-005	-006	-007	-008	-009	-010	-011	1	\$18.00
8BR0703-xxx	Full Dummy Handleset	-001	-003	-004	-005	-006	-007	-008	-009	-010	-011	1	\$2.00
8BR0704-xxx	Single Cylinder Deadbolt	-001	-003	-004	-005	-006	-007	-008	-009	-010	-011	1	\$7.00
8BR0705-xxx	Double Cylinder Deadbolt	-001	-003	-004	-005	-006	-007	-008	-009	-010	-011	1	\$7.00
8BR0706-xxx	Entry Knob/Lever, C-Keyway	-001	-003	-004	-005	-006	-007	-008	-009	-010	-011	1	\$10.00
8BR0707-xxx	Privacy/Passage Knob/Lever	-001	-003	-004	-005	-006	-007	-008	-009	-010	-011	1	\$6.00
8BR0708-xxx	Full Dummy Knob/Lever	-001	-003	-004	-005	-006	-007	-008	-009	-010	-011	1	\$2.00
8BR0709-xxx	Patio Deadbolt	-001	-003	-004	-005	-006	-007	-008	-009	-010	-011	1	\$7.00
8BR0717-xxx	Egress Active Handlesets	-001	-003	-004	-005	-006	-007	-008	-009	-010	-011	1	\$18.00

THIN DOOR KITS (Available only on Napa and Westcliff handlesets)

Core Part No.	Item	FINISHES										Qty.	List Price
		003	112	150	152	260	481	492	055	190	044		
8BR0710-xxx	Single Cylinder Deadbolt	-001	-003	-004	-005	-006	N/A	N/A	-009	-010	-011	1	\$41.00
8BR0711-001	Double Cylinder Deadbolt	N/A	N/A	N/A	N/A	N/A	N/A	N/A	N/A	N/A	N/A	1	\$41.00

INTERIOR DEADBOLT TURNPIECES

Core Part No.	Item	FINISHES										Qty.	List Price
		003	112	150	152	260	481	492	055	190	044		
8BR0801-xxx	Traditional Round	-001	-003	-004	-005	-006	N/A	N/A	-007	-008	-011	1	\$21.00
8BR0802-xxx	Traditional Arch	-001	-003	-004	-005	-006	N/A	N/A	-007	-008	-011	1	\$21.00
8BR0803-xxx	Traditional Square	-001	-003	-004	-005	-006	N/A	N/A	-007	-008	-011	1	\$21.00
8BR0804-xxx	Contemporary Round	N/A	-001	-002	N/A	-003	N/A	N/A	-004	-005	-011	1	\$21.00
8BR0805-xxx	Contemporary Square	N/A	-001	-002	N/A	-003	N/A	N/A	-004	-005	-011	1	\$21.00
8BR0806-xxx	Rustic Arch	N/A	N/A	N/A	N/A	N/A	-001	-002	N/A	N/A	N/A	1	\$23.00
8BR0807-xxx	Rustic Square	N/A	N/A	N/A	N/A	N/A	-001	-002	N/A	N/A	N/A	1	\$23.00

BUILDING A SERVICE PART NUMBER



To create service part # combine core and function suffix.
 Example: **8BR0501-001**
 For Single Cylinder screwpack in polished brass (Standard door thickness).

TO ORDER: COMBINE PART NO. AND FINISH SUFFIX EX: 8BR0801-XXX AND -003 = 8BR0801-003

NOTES

CONDITIONS OF SALE

TERMS: 2%/25 Days, Net 30

SHIPPING: U.S. Customers – F.O.B. Locks in Charlotte, NC and Accessories in Edgerton, KS. Full freight allowed on Baldwin Reserve purchase orders sent through routing of our selection. Delivery is made to curb or dockside only. Freight allowed shipments to Alaska will be prepaid to Seattle, to Hawaii will be prepaid to San Francisco, and to Puerto Rico will be prepaid to Miami. Upon delivery to the transportation company, shipments become the property of the purchasers, who assume full risk for loss or damage in transit. International Customers – Orders will ship FCA to U.S. city specified on the commercial invoice. Exceptions will be subject to the INCO terms stated on the commercial invoice. Canadian customers should contact their sales representative for variations to these terms.

CLAIMS: All claims, whether referring to errors in prices, filling orders, or for defective goods, must be submitted IN WRITING within 30 days after receipt of shipment. Each claim must be in writing, briefly describe the defect, be accompanied by a proof of purchase and be received during the lifetime of the product or during the period that the original consumer purchaser owns the product. The claimant must provide to his or her Baldwin dealer or retailer other information and evidence reasonably required by Baldwin and, if requested, must permit inspection of the product by Baldwin or its representatives. If, after investigation, Baldwin determines that the claim is valid, the remedy will be performed by or on behalf of Baldwin in accordance with the above heading, "Remedies".

FREIGHT: Baldwin Reserve lock products are made-to-order and ship within five to seven business days from the time the order is entered, unless otherwise communicated. Baldwin customers can enjoy free 3-day shipping on all orders anywhere in the continental U.S. To expedite shipping, Baldwin also offers expedited freight services for a fee; please contact customer service for details. All shipping lead times are from the date the order is entered into the Baldwin system.

MINIMUM ORDERS: There is no minimum order quantity.

COMBINED ORDERS: Baldwin Reserve orders can be combined with other Baldwin products on the same purchase order; combined orders will ship separately. "Shipping complete" is not available for combined orders of Baldwin Reserve with other Baldwin products.

ORDERS: We reserve the right to decline the whole or part of orders in which the price, finishes or quantity of goods is not satisfactory to us. We reserve the right to discontinue items or change specifications at any time without notice and without incurring any obligations. The corporation cannot be liable for extended delivery dates which may result in the cancellation of an order.

RETURNED GOODS: Returned goods will not be accepted unless authorized in writing by Baldwin within 120 days of invoice date. A minimum of 25% handling charge and freight will be charged on all items returned in original condition. An 80% handling charge will be imposed on all damaged products. Special and custom products are not returnable for credit. No credit will be given for items returned without written authorization, nor will the items be returned to the customer. Authorized returns become void after a period of 30 days from issue date of the Returned Goods Authorization. All credit returns must be shipped to a location specified by Baldwin, FREIGHT PREPAID.

CANCELLATIONS AND CHANGES: While Baldwin will attempt to comply with a customer's request to cancel/change an order, we cannot guarantee this can be accomplished before the factory begins assembly. A 25% handling charge will be applied to cancellations where assembly has started before receipt of a customer's change order request.

PRICES: The list price effective on the date the customer order is received will determine billing price. Prices are subject to change without notice. Orders being held by Baldwin because of account credit status may be re-priced to the price in effect the day the order is released by the Baldwin Credit Department. Orders requiring delivery in excess of three (3) months will be billed at prices in effect at time of shipment, unless quoted to the contrary in writing by our company.

SPECIFICATIONS: Packing, weights, measurements, and design are subject to change without notice.

Refer to www.baldwinhardware.com for a complete warranty statement.

BALDWIN PORTFOLIO COMPARISON

Baldwin luxury is available in a range of styles, finishes, and price points within the various product portfolios: Estate, Reserve, and Prestige Series. Whatever your customer's design aesthetic, Baldwin has a product to fit their design needs.

	ESTATE™	RESERVE™	<i>Prestige Series™</i>
STYLE & FINISH OFFERING	\$\$\$-\$\$\$\$	\$\$	\$
Knob/Lever Style Options	66	14	6
Rose Style Options	54	8	6
Entry Style Options	51	15	8
Finishes Available	14	10	4
PVD Lifetime Finishes	○	○	-
Lacquer Finishes	○	●	●
Living Finishes	○	-	-
Concealed Screws and Fasteners	●	-	-
PERFORMANCE, OPERATION, APPLICATION			
Lifetime Mechanical Warranty	●	●	●
Tubular Lock Operation	○	○	●
Mortise Lock Operation	○	-	-
Multipoint Application	○	○	-
Emergency Egress Entry	○	○	-
Latch Operation	28° Rotation with Nylon insert for quiet operation	Adjustable Backset	Adjustable Backset
Handle Grip Material	Brass	Brass	Brass
Knob/Lever Material	Brass	Brass	Cast Metal
CYLINDER TECHNOLOGY			
C-Keyway Cylinder	●	●	-
SmartKey® Cylinder	-	○	●
Keyless Entry/Electronic Locks	○	-	-
Master Keying	○	○	-
Construction Keying	○	○	-
Other Specialty Keying	○	-	-
AVAILABLE OPTIONS			
Preconfigured Locksets	Yes	-	Yes
Customization	Yes	Yes	-
Coordinating Home Hardware	Yes	Yes	-
Coordinating Cabinet Hardware	Yes	-	-
Primary Ordering	Select Preconfigured A la Carte	Configured	Preset SKUs

● Standard ○ Optional - Not Available

TRADITIONAL

CONTEMPORARY

RUSTIC

HANDLESETS

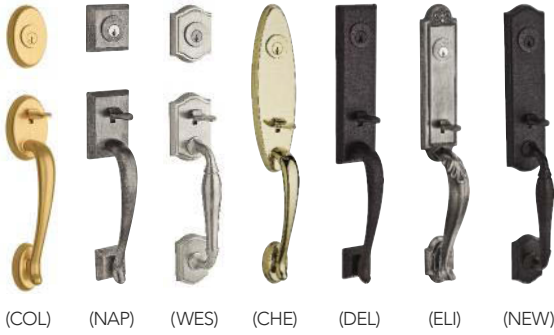

DEADBOLTS

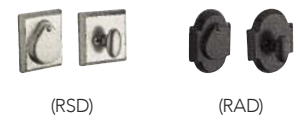
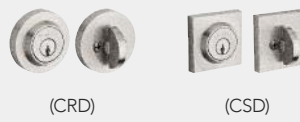

KNOBS/LEVERS



MULTIPOINT

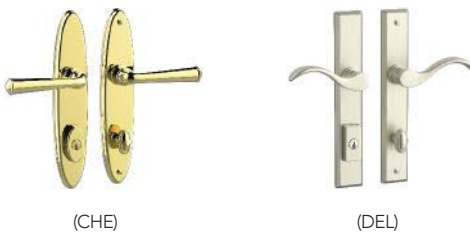

ROSES & EGRESS TRIMS



FINISHES

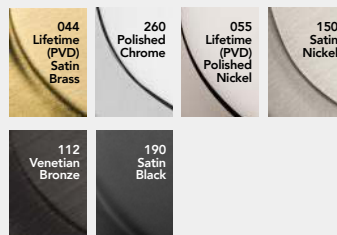
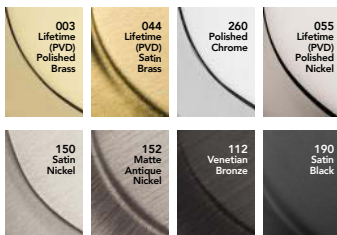

Baldwin Reserve offers additional options to ensure the product meets your project specification.

- Options Include: Strike, Cylinder, and Keying. Service Part Kits for Door Thickness and Latch Type are also available.
- Add custom options to the product description based on the example format below:

QTY 2 EN.CUR.L.TRR.150.6L.DS.CKY.K2

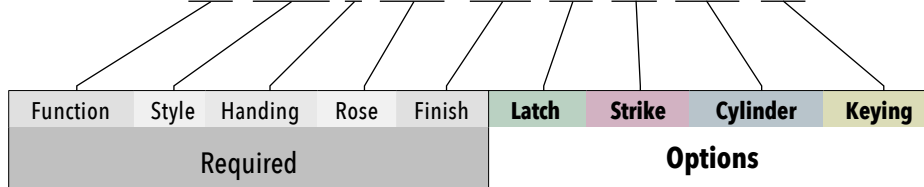

If no options are specified, the product will ship with:

- Square corner adjustable latches
- Square corner strike
- Keyed different (if keyed product)
- C-Keyway cylinder

Door Thickness	Latch	List Price Adder	Strike	List Price Adder	Cylinder	Keying	List Price Adder
<i>Handlesets/Deadbolts</i> 1.75" to 2" Doors	<i>(6L) 6 Way Latch Kit</i>	N/A	<i>(DS) Dual Strike Kit</i>	N/A	<i>(CKY) C-Keyway Pin & Tumbler</i>	<i>(KD) Keyed Different</i>	N/A
(STD) <i>Patio Deadbolts</i> 1.375" to 2" Doors			(FS) Full Lip Deadbolt Strike (only available on deadbolt)	N/A	(SMT) SmartKey (only available on handlesets & deadbolt)	(KA) Keyed Alike (A=#)	N/A
<i>Knobs/Levers</i> 1.375" to 2" Doors						(CK) Construction Key*	\$15.00
						(KC) Key Code	N/A
						(MK) Master Key*	\$15.00
						(WITH) Separate Lines Keyed Together	N/A

*Construction Key and Master Key not available with SmartKey cylinder.
Thick and Thin Door Service Part Kits are available for order (pg.51).
UL Latch Service Part Kits are available for order (pg.48).

Orders will ship with default options, in bold above, unless otherwise specified

KEYING

(KD) KEYED DIFFERENT

All keyed locks will ship KD unless otherwise specified.

(KA) KEYED ALIKE

All locks on the same line item are keyed alike.

Example. 2 SC.TRD.150.K2

- Quantity
- The line item represents the deadbolt style and finish.
- K2 represents that the two locks are keyed alike.

(CK) CONSTRUCTION KEYING

Allows a builder to operate a lock during construction. Once the homeowner uses their key, the builder key is rendered inoperable.

Example. SC.TRD.150.CK 35829

- CK indicates the cylinder should be Construction Keyed.
- Represents the builder key code – must be specified when ordering.

(KC) KEY CODE

Keys lock to a specific key-cut
Example. SC.TRD.150.35829

- Represents customer specified key cut.

(WITH) WITH ORDERS

Keys multiple line items of locks together
Example. SC.TRD.150.WITH

- Represents end of bundle and total quantity of locks keyed together.
- Item to be keyed

(MK) MASTER KEYING

Allows multiple keys to operate a single lock. Often used in multi-family applications for owners and tenants.

Allows maintenance access.

Example. SC.TRD.150.MK 59579

- MK indicates the cylinder should be Master Keyed.
- Represents the Master Key Code – must be specified when ordering.

BALDWIN®

19701 DA VINCI, LAKE FOREST, CALIFORNIA 92610

800.437.7448 · [BALDWINHARDWARE.COM](https://www.baldwinhardware.com)