

Rebated drop seals  
for hinged doors

# Classic solutions for everyday doors

Our range of rebated drop seals for timber doors is already well-established in the industry following **decades of assured quality** and consistent innovation. This type of drop seal is fitted into a grooved rebate in the bottom of timber doors, remaining hidden during daily use. As a result, door designers can meet performance requirements whilst maintaining the door's aesthetic quality regardless of the chosen material, style and finish.

The seal drops automatically when the door is closed to form a seal with the floor, retracting when the door is opened to ensure the door operation is unhindered. This section contains options for use with both hinged and pivoted timber doors. Their main purpose is to provide an **effective barrier against sound** transfer at the door threshold, as well as smoke, air, light, dirt, dust, insects and odours. We have tested options for specialist applications including protection from radiation, corrosion and weather elements such as wind and driving rain.



**Rebated drop seals**  
for hinged doors



# Schall-Ex® L-8/30 WS

## 1-1000

- / for the 2nd sealing level of highly sound-insulating doors
- / parallel lowering
- / no offset of the inner profile
- / slide-out inner profile
- / level compensation for uneven floors



### TECHNICAL DATA

Application	hinged timber doors
Actuation	single
Gasket material	self-extinguishing silicone

### DIMENSIONS

Width x height	8 x 30 mm
Standard lengths	708, 833, 958, 1083, 1208 mm
Minimum lengths*	235 mm
Maximum lengths	2000 mm
Can be shortened by	125 mm
Travel	20 mm

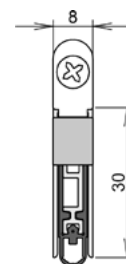

### FIXING/MONTAGE

Fixing	rebated into a groove in the door, screw fixed either side
Accessories included with delivery	5820

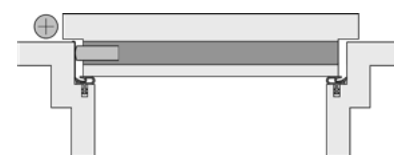

### PERFORMANCE & CERTIFICATES

Fire	UL 10C (R38166)
------	-----------------

\* min. lengths cannot be shortened

# M-12/12 RS

## 1-744

- / small installation dimensions
- / fits in the euro groove of profile doors



### TECHNICAL DATA

Application	hinged timber & PVC doors
Actuation	single
Gasket material	TPE

### DIMENSIONS

Width x height	11,8 x 17,8 mm
Standard lengths	customized
Minimum lengths*	320 mm
Maximum lengths	1600 mm
Can be shortened by	125 mm, smallest product length that can be shortened: 441 mm
Travel	8 mm

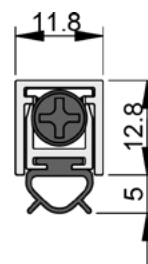

### FIXING/MONTAGE

Fixing	screw fixed into the chamber at the underside of the door
Accessories included with delivery	S016

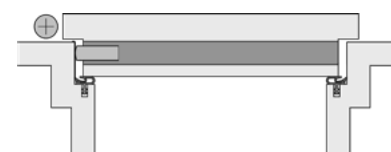

\* min. lengths cannot be shortened

# M-12/20 RS

## 1-723

- / hinged timber door drop seal
- / slimline design and lightweight operation



### TECHNICAL DATA

Application	hinged timber doors
Actuation	single
Gasket material	TPE

### DIMENSIONS

Width x height	11,8 x 20 mm
Standard lengths	customized
Minimum lengths*	260 mm
Maximum lengths	1525 mm
Can be shortened by	150 mm, smallest product length that can be shortened: 435 mm
Travel	12 mm

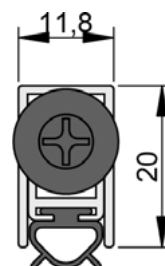

### FIXING/MONTAGE

Fixing	rebated into a groove in the door, screw fixed to the underside
Accessories included with delivery	S011

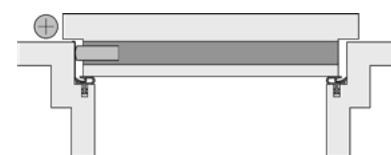

### PERFORMANCE & CERTIFICATES

Acoustic	35dB over 5mm gap, 33dB over 10mm gap
----------	---------------------------------------

\* min. lengths cannot be shortened

# M-12/30 RS

## 1-725

- / hinged timber door drop seal
- / slimline design and lightweight operation



### TECHNICAL DATA

Application	hinged timber doors
Actuation	single
Gasket material	TPE

### DIMENSIONS

Width x height	11,8 x 30 mm
Standard lengths	customized
Minimum lengths*	320 mm
Maximum lengths	1530 mm
Can be shortened by	125 mm, smallest product length that can be shortened: 445 mm
Travel	15 mm

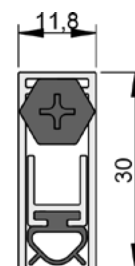

### FIXING/MONTAGE

Fixing	rebated into a groove in the door, screw fixed to the underside
Accessories included with delivery	S011

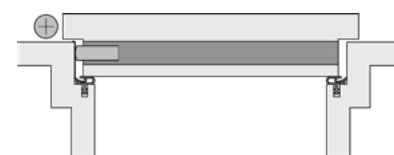

### PERFORMANCE & CERTIFICATES

Acoustic	37dB over 4mm gap, 33dB over 10mm gap
----------	---------------------------------------

\* min. lengths cannot be shortened

# M-12/30 EK

## 1-726

- / hinged timber door drop seal
- / slimline design and lightweight operation
- / end plates provide neat finish



### TECHNICAL DATA

Application	hinged timber doors
Actuation	single
Gasket material	TPE

### DIMENSIONS

Width x height	11,8 x 30 mm
Standard lengths	customized
Minimum lengths*	320 mm
Maximum lengths	1530 mm
Can be shortened by	125 mm, smallest product length that can be shortened: 445 mm
Travel	15 mm

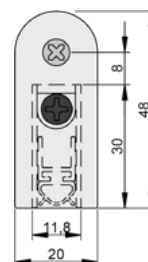

### FIXING/MONTAGE

Fixing	rebated into a groove in the door, screw fixed either side
Accessories included with delivery	S005

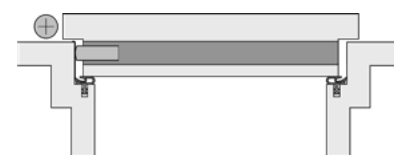

### PERFORMANCE & CERTIFICATES

Acoustic	37dB over 4mm gap, 33dB over 10mm gap
----------	---------------------------------------

\* min. lengths cannot be shortened

# Isolporte Standard

**1-153**



## TECHNICAL DATA

Application	hinged timber doors
Actuation	single
Gasket material	self-extinguishing silicone

## DIMENSIONS

Width x height	12 x 31 mm
Standard lengths	customized
Minimum lengths*	280 mm
Maximum lengths	1335 mm
Can be shortened by	125 mm
Travel	12 mm

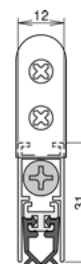

## FIXING/MONTAGE

Fixing	rebated into a groove in the door, screw fixed either side
Accessories included with delivery	7320

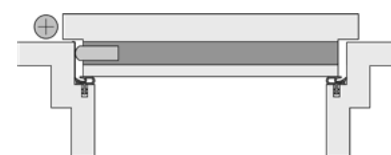

\* min. lengths cannot be shortened

**2 Drop seals**  
2.1 rebated drop seals for hinged doors

athmer.com



# Isolporte Omega

1-147



## TECHNICAL DATA

Application	hinged timber doors
Actuation	single
Gasket material	self-extinguishing silicone

## DIMENSIONS

Width x height	12 x 28 mm
Standard lengths	customized
Minimum lengths*	280 mm
Maximum lengths	1335 mm
Can be shortened by	125 mm
Travel	12 mm

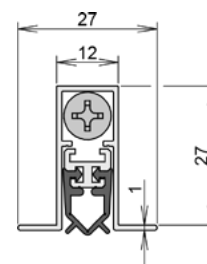

## FIXING/MONTAGE

Fixing	rebated into a groove in the door, screw fixed to the underside
Accessories included with delivery	7503

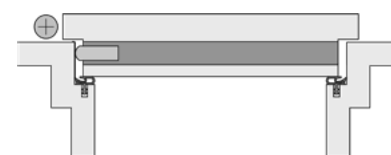

\* min. lengths cannot be shortened



# Doppeldicht M-12/35

## 1-392

- / slimline profile drop seal
- / deeper grooves up to 40mm possible
- / also available with DUO double actuation



### TECHNICAL DATA

Application	hinged timber doors
Actuation	single
Gasket material	self-extinguishing silicone

### DIMENSIONS

Width x height	12 x 35 mm
Standard lengths	708, 833, 958, 1083, 1208 mm
Minimum lengths*	220 mm
Maximum lengths	1335 mm
Can be shortened by	125 mm from standard lengths
Travel	11 mm

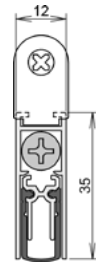

### FIXING/MONTAGE

Fixing	rebated into a groove in the door, screw fixed either side
Accessories included with delivery	5220

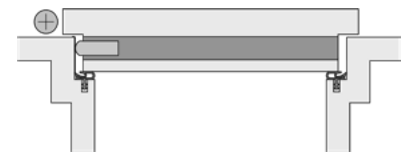

### PERFORMANCE & CERTIFICATES

Fire	UL10B & UL10C (R38166)
Acoustic	49dB over 7mm gap, 46dB over 10mm gap

\* min. lengths cannot be shortened



# Schall-Ex® L-14/35 EK

## 1-935

- / drop seal with common groove dimension
- / parallel drop minimises friction with the floor
- / tool-free actuator can be deactivated before building occupancy
- / actuator requires no protective press plate for the frame
- / end plates provide neat finish



### TECHNICAL DATA

Application	hinged timber doors
Actuation	single
Gasket material	self-extinguishing silicone

### DIMENSIONS

Width x height	14 x 35 mm
Standard lengths	635, 735, 835, 935, 1035, 1135, 1235 mm
Minimum lengths*	235 mm
Maximum lengths	1635 mm
Can be shortened by	100 mm from standard lengths
Travel	20 mm

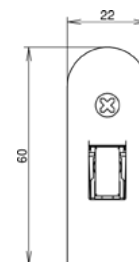

### FIXING/MONTAGE

Fixing	rebated into a groove in the door, screw fixed either side
Accessories included with delivery	5519

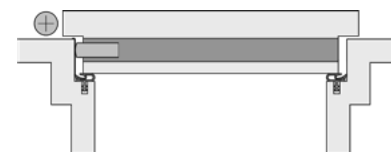

### PERFORMANCE & CERTIFICATES

Fire	EN 1634-1**, UL10B & UL10C (R38166)
Acoustic	51dB over 7mm gap, 44dB over 12mm gap
Smoke	Certifire TS21 (CF 5675)

\* min. lengths cannot be shortened

\*\*The test value may differ according to the EN 1634-1 test, as the complete door system must be checked.



# M-15/30 EK

## 1-741

- / hinged timber door drop seal
- / also available with duo double actuation
- / end plates provide neat finish



### TECHNICAL DATA

Application	hinged timber doors
Actuation	single
Gasket material	self-extinguishing silicone

### DIMENSIONS

Width x height	14,8 x 30 mm
Standard lengths	customized
Minimum lengths*	235 mm
Maximum lengths	1900 mm
Can be shortened by	125 mm, smallest product length that can be shortened: 708 mm
Travel	11 mm

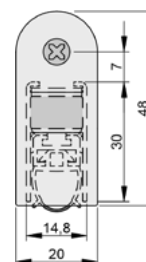

### FIXING/MONTAGE

Fixing	rebated into a groove in the door, screw fixed either side
Accessories included with delivery	S014

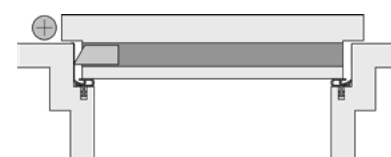

### PERFORMANCE & CERTIFICATES

Fire	UL 10C (R38166), EN 1634-1**
Acoustic	44dB over 7mm gap, 42dB over 10mm gap

### FURTHER VARIANTS

double actuation 1-740  
 (techn. data may differ)

\* min. lengths cannot be shortened

\*\*The test value may differ according to the EN 1634-1 test, as the complete door system must be checked.

2 Drop seals  
2.1 rebated drop seals for hinged doors

athmer.com



# M-15/30 WS

## 1-185

- / the classic timber door drop seal
- / hinged timber door drop seal
- / also available with DUO double actuation



### TECHNICAL DATA

Application	hinged timber doors
Actuation	single
Gasket material	self-extinguishing silicone

### DIMENSIONS

Width x height	14,8 x 30 mm
Standard lengths	customized
Minimum lengths*	235 mm
Maximum lengths	1900 mm
Can be shortened by	125 mm, smallest product length that can be shortened: 708 mm
Travel	11 mm

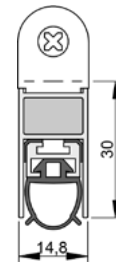

### FIXING/MONTAGE

Fixing	rebated into a groove in the door, screw fixed either side
Accessories included with delivery	S002

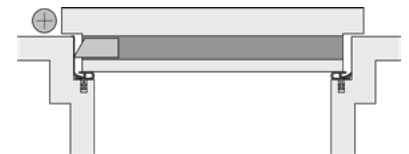

### PERFORMANCE & CERTIFICATES

Fire	UL 10C (R38166), EN 1634-1**
Acoustic	44dB over 7mm gap, 42dB over 10mm gap

### FURTHER VARIANTS

double actuation 1-184  
 (techn. data may differ)

\* min. lengths cannot be shortened

\*\*The test value may differ according to the EN 1634-1 test, as the complete door system must be checked.



# M-15/28 OS

## 1-179

- / hinged timber door drop seal
- / also available with DUO double actuation



### TECHNICAL DATA

Application	hinged timber doors
Actuation	single
Gasket material	self-extinguishing silicone

### DIMENSIONS

Width x height	14,8 x 28 mm
Standard lengths	customized
Minimum lengths*	235 mm
Maximum lengths	1900 mm
Can be shortened by	125 mm, smallest product length that can be shortened: 708 mm
Travel	11 mm

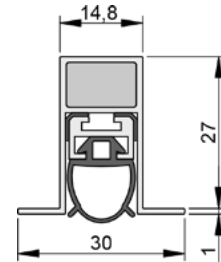

### FIXING/MONTAGE

Fixing	rebated into a groove in the door, screw fixed to the underside
Accessories included with delivery	S001

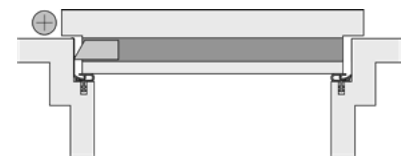

### PERFORMANCE & CERTIFICATES

Fire	UL 10C (R38166), EN 1634-1**
Acoustic	44dB over 7mm gap, 42dB over 10mm gap

### FURTHER VARIANTS

double actuation 1-178  
 (techn. data may differ)

\* min. lengths cannot be shortened

\*\*The test value may differ according to the EN 1634-1 test, as the complete door system must be checked.

2 Drop seals  
2.1 rebated drop seals for hinged doors

athmer.com



## NEW GENERATION

/ The latest generation introduces an industry-wide benchmark with regard to quality and performance for timber doors

## UNCOMPROMISED ACOUSTIC PERFORMANCE

/ Designed with the latest technology to reduce sound flanking and achieve the highest performance over a range of gaps

# SCHALL-EX<sup>®</sup> L-15 THE STATE OF THE ART DROP SEAL

## CERTIFIED QUALITY

- / Testing and auditing from world-leading third-party certification schemes provide confidence in L-15's product quality and consistency

## DURABILITY YOU CAN DEPEND ON

- / L-15's host of new features including parallel drop protect the seal and door frame from damage and reduce sealing friction

## FLUSH BOLT INTEGRATION

- / Schall-Ex® L-15 can be integrated with a flush bolt, maintaining optimal acoustic performance on double doors





# Schall-Ex® L-15/30 EK

## 1-1017

- / the state of the art drop seal
- / parallel drop minimises friction with the floor
- / tool-free actuator can be deactivated before building occupancy
- / actuator requires no protective press plate for the frame
- / no lateral travel during actuation enhances



### TECHNICAL DATA

Application	hinged timber doors
Actuation	single
Gasket material	self-extinguishing silicone

### DIMENSIONS

Width x height	14,8 x 30 mm
Standard lengths	708, 833, 958, 1083, 1208 mm
Minimum lengths*	235 mm
Maximum lengths	2000 mm
Can be shortened by	125 mm from standard lengths
Travel	20 mm

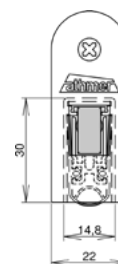

### FIXING/MONTAGE

Fixing	rebated into a groove in the door, screw fixed either side
Accessories included with delivery	5205

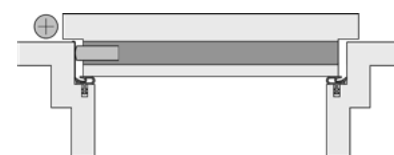

### PERFORMANCE & CERTIFICATES

Fire	EN 1634-1**
Acoustic	52dB over 7mm gap, 51dB over 12mm gap

\* min. lengths cannot be shortened

\*\*The test value may differ according to the EN 1634-1 test, as the complete door system must be checked.



# Schall-Ex® L-15/30 WS

## 1-880

- / the state of the art drop seal
- / parallel drop minimises friction with the floor
- / tool-free actuator can be deactivated before building occupancy
- / actuator requires no protective press plate for the frame
- / no lateral travel during actuation enhances



### TECHNICAL DATA

Application	hinged timber & metal doors
Actuation	single
Gasket material	self-extinguishing silicone

### DIMENSIONS

Width x height	14,8 x 30 mm
Standard lengths	708, 833, 958, 1083, 1208 mm
Minimum lengths*	235 mm
Maximum lengths	2000 mm
Can be shortened by	125 mm from standard lengths
Travel	20 mm

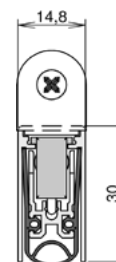

### FIXING/MONTAGE

Fixing	rebated into a groove in the door, screw fixed either side
Accessories included with delivery	5382

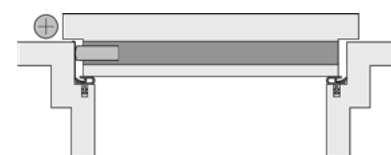

### PERFORMANCE & CERTIFICATES

Fire	EN 1634-1**, UL 10B & 10C (R38166)
Acoustic	52dB over 7mm gap, 51dB over 12mm gap
Smoke	Certifire TS21 (CF 5675)

### FURTHER VARIANTS

double actuation 1-382  
 (techn. data may differ)

\* min. lengths cannot be shortened

\*\*The test value may differ according to the EN 1634-1 test, as the complete door system must be checked.

2 Drop seals  
 2.1 rebated drop seals for hinged doors

athmer.com

# Schall-Ex® L-15/30 OS

## 1-881

- / the state of the art drop seal
- / parallel drop minimises friction with the floor
- / tool-free actuator can be deactivated before building occupancy
- / actuator requires no protective press plate for the frame
- / no lateral travel during actuation enhances gasket position

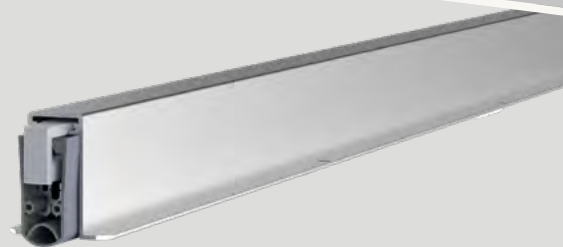

### TECHNICAL DATA

Application	hinged timber & metal doors
Actuation	single
Gasket material	self-extinguishing silicone

### DIMENSIONS

Width x height	14,8 x 30 mm
Standard lengths	708, 833, 958, 1083, 1208 mm
Minimum lengths*	235 mm
Maximum lengths	2335 mm
Can be shortened by	125 mm from standard lengths
Travel	20 mm

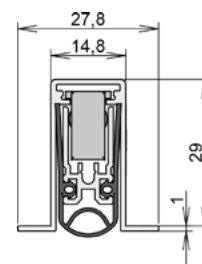

### FIXING/MONTAGE

Fixing	rebated into a groove in the door, screw fixed to the underside
--------	---

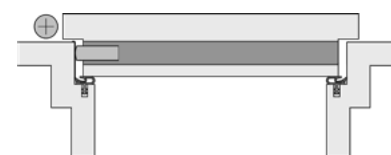

### PERFORMANCE & CERTIFICATES

Fire	EN 1634-1**, UL 10B & 10C [R38166]
Acoustic	52dB over 7mm gap, 51dB over 12mm gap
Smoke	Certifire TS21 [CF 5675]

\* min. lengths cannot be shortened

\*\*The test value may differ according to the EN 1634-1 test, as the complete door system must be checked.



# L-15/38 WS

## 1-172

/ hinged timber door drop seal



### TECHNICAL DATA

Application	hinged timber doors, hinged timber gates
Actuation	single
Gasket material	self-extinguishing silicone

### DIMENSIONS

Width x height	14,8 x 38 mm
Standard lengths	customized
Minimum lengths*	300 mm
Maximum lengths	1700 mm
Can be shortened by	125 mm, smallest product length that can be shortened: 461 mm
Travel	20 mm

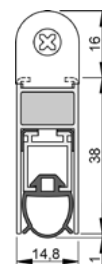

### FIXING/MONTAGE

Fixing	rebated into a groove in the door, screw fixed either side
Accessories included with delivery	S002

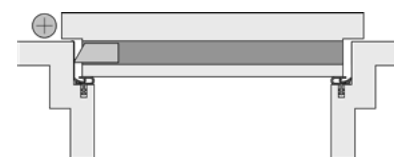

### PERFORMANCE & CERTIFICATES

Fire	EN 1634-1**
Acoustic	43dB over 7mm gap, 42dB over 10mm gap, 39dB over 15mm gap

\* min. lengths cannot be shortened

\*\*The test value may differ according to the EN 1634-1 test, as the complete door system must be checked.

# L-15/35 OS

## 1-169

/ hinged timber door drop seal



### TECHNICAL DATA

Application	hinged timber doors, hinged timber gates
Actuation	single
Gasket material	self-extinguishing silicone

### DIMENSIONS

Width x height	14,8 x 35 mm
Standard lengths	customized
Minimum lengths*	300 mm
Maximum lengths	2000 mm
Can be shortened by	125 mm, smallest product length that can be shortened: 461 mm
Travel	20 mm

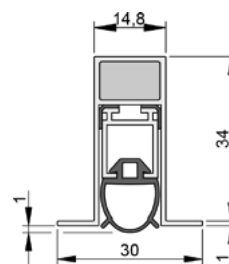

### FIXING/MONTAGE

Fixing	rebated into a groove in the door, screw fixed to the underside
Accessories included with delivery	S001

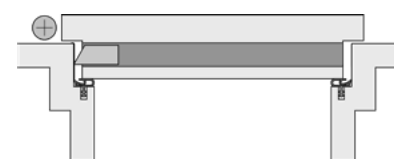

### PERFORMANCE & CERTIFICATES

Fire	EN 1634-1**
Acoustic	43dB over 7mm gap, 42dB over 10mm gap, 39dB over 15mm gap

\* min. lengths cannot be shortened

\*\*The test value may differ according to the EN 1634-1 test, as the complete door system must be checked.



# Schall-Ex® Ultra

## 1-291

- / corrosion-resistant drop seal
- / salt spray tested to EN 1670, Class 5 (480 hours)
- / ideal for use in high humidity environments
- / overload protection protects seal from excessive wear
- / also available with double actuation



### TECHNICAL DATA

Application	hinged timber & metal doors, hinged timber & metal gates
Actuation	single
Gasket material	self-extinguishing silicone

### DIMENSIONS

Width x height	19,7 x 30 mm
Standard lengths	708, 833, 958, 1083, 1208 mm
Minimum lengths*	220 mm
Maximum lengths	2000 mm
Can be shortened by	125 mm from standard lengths
Travel/Hub	12 mm



### FIXING/MONTAGE

Fixing	rebated into a groove in the door, screw fixed either side
Accessories included with delivery	5610

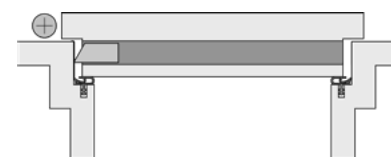

### PERFORMANCE & CERTIFICATES

Fire	UL10B & UL10C (R31866)
Smoke	Certifire TS21 (CF 5675) Acoustic: 51dB over 7mm gap

### FURTHER VARIANTS

double actuation 1-290  
 [techn. data may differ]

\* min. lengths cannot be shortened

2 Drop seals  
 2.1 rebated drop seals for hinged doors

athmer.com



# Schall-Ex® Ultra OS

## 1-293

- / corrosion-resistant drop seal
- / salt spray tested to EN 1670, Class 5 (480 hours)
- / ideal for use in high humidity environments
- / overload protection protects seal from excessive wear
- / also available with double actuation



### TECHNICAL DATA

Application	hinged timber & metal doors, hinged timber & metal gates
Actuation	single
Gasket material	self-extinguishing silicone

### DIMENSIONS

Width x height	19,7 x 30 mm
Standard lengths	708, 833, 958, 1083, 1208 mm
Minimum lengths*	220 mm
Maximum lengths	2000 mm
Can be shortened by	125 mm from standard lengths
Travel	12 mm

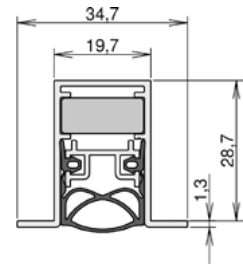

### FIXING/MONTAGE

Fixing	rebated into a groove in the door, screw fixed to the underside
Accessories included with delivery	5503

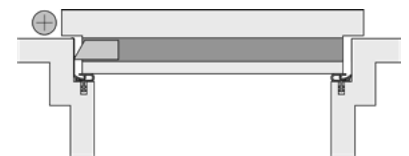

### PERFORMANCE & CERTIFICATES

Fire	UL10B & UL10C (R31866)
Smoke	Certifire TS21 (CF 5675) Acoustic: 51dB over 7mm gap

### FURTHER VARIANTS

double actuation 1-292  
 (techn. data may differ)

\* min. lengths cannot be shortened

# Schall-Ex® Radiation Protection WS

## 1-529

- / radiation-resistant drop seal
- / suitable for use with radiation protection doors in accordance with DIN 6834
- / lead-lined gasket perfect for medical use in x-ray rooms, etc.
- / also available with double actuation



### TECHNICAL DATA

Application	hinged timber doors
Actuation	single
Gasket material	self-extinguishing silicone, lead rubber

### DIMENSIONS

Width x height	19,7 x 30 mm
Standard lengths	708, 833, 958, 1083, 1208 mm
Minimum lengths*	220 mm
Maximum lengths	2000 mm
Can be shortened by	125 mm
Travel	12 mm

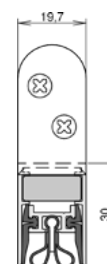

### FIXING/MONTAGE

Fixing	rebated into a groove in the door, screw fixed either side
Accessories included with delivery	5610

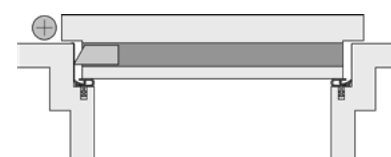

### FURTHER VARIANTS

double actuation 1-528  
[techn. data may differ]

\* min. lengths cannot be shortened



# Schall-Ex® Radiation Protection WS BD

## 1-521

- / radiation-resistant drop seal
- / suitable for use with radiation protection doors in accordance with DIN 6834
- / lead-lined gasket perfect for medical use in x-ray rooms, etc.
- / also available with double actuation



### TECHNICAL DATA

Application	hinged timber doors
Actuation	single
Gasket material	silicone self-extinguishing, lead rubber

### DIMENSIONS

Width x height	19,7 x 30 mm
Standard lengths	708, 833, 958, 1083, 1208 mm
Minimum lengths*	220 mm
Maximum lengths	2000 mm
Can be shortened by	125 mm from standard lengths
Travel	12 mm

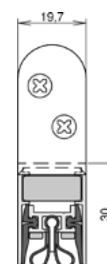

### FIXING/MONTAGE

Fixing	rebated into a groove in the door, screw fixed either side
Accessories included with delivery	5610

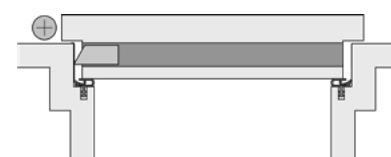

### FURTHER VARIANTS

double actuation                      1-522  
[techn. data may differ]

\* min. lengths cannot be shortened

# Schall-Ex® Radiation Protection OS

## 1-295

- / radiation-resistant drop seal
- / suitable for use with radiation protection doors in accordance with DIN 6834
- / lead-lined gasket perfect for medical use in x-ray rooms, etc.
- / also available with double actuation



### TECHNICAL DATA

Application	hinged timber & metal doors
Actuation	single
Gasket material	silicone self-extinguishing, lead rubber

### DIMENSIONS

Width x height	19,7 x 30 mm
Standard lengths	708, 833, 958, 1083, 1208 mm
Minimum lengths*	708 mm
Maximum lengths	1500 mm
Can be shortened by	125 mm from standard lengths
Travel	12 mm

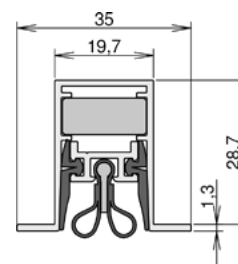

### FIXING/MONTAGE

Fixing	rebated into a groove in the door, screw fixed to the underside
Accessories included with delivery	5420

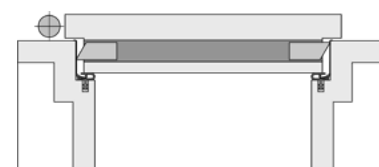

### FURTHER VARIANTS

double actuation 1-294  
(techn. data may differ)

\* min. lengths cannot be shortened

2 Drop seals  
2.1 rebated drop seals for hinged doors

athmer.com

# Schall-Ex® Radiation Protection OS BD

## 1-519

- / radiation-resistant drop seal
- / suitable for use with radiation protection doors in accordance with DIN 6834
- / lead-lined gasket perfect for medical use in x-ray rooms, etc.
- / also available with double actuation



### TECHNICAL DATA

Application	hinged timber doors
Actuation	single
Gasket material	silicone self-extinguishing, lead rubber

### DIMENSIONS

Width x height	19,7 x 30 mm
Standard lengths	708, 833, 958, 1083, 1208 mm
Minimum lengths*	220 mm
Maximum lengths	2000 mm
Can be shortened by	125 mm from standard lengths
Travel	12 mm

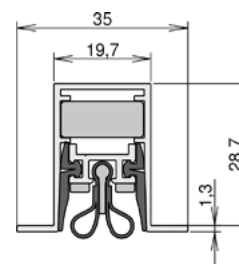

### FIXING/MONTAGE

Fixing	rebated into a groove in the door, screw fixed to the underside
Accessories included with delivery	5503

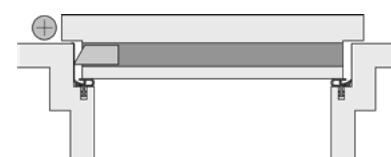

### FURTHER VARIANTS

double actuation 1-520  
[techn. data may differ]

\* min. lengths cannot be shortened



## **MODULAR COMPONENTS FOR GREATER FLEXIBILITY**

- / Wide range of sizes and fixing variations based on the same mechanical philosophy for more flexibility in predetermined spaces

## **SUITABLE FOR ALL MATERIAL TYPES**

- / Suitable for system doors made from various types of material - including PVC, steel and aluminium

# STADI

## THE MODULAR SYSTEM DOOR SEAL



### QUALITY YOU CAN DEPEND ON

- / Confidence in Stadi's product quality and consistency is provided by testing and auditing from world-leading third-party certification schemes

### IMPROVED DURABILITY

- / Stadi's host of new features including overload protection protect the seal and door frame from damage and reduce sealing friction

### FLUSH BOLT INTEGRATION

- / All size options can be integrated with a flush bolt, maintaining optimum acoustic performance on double doors

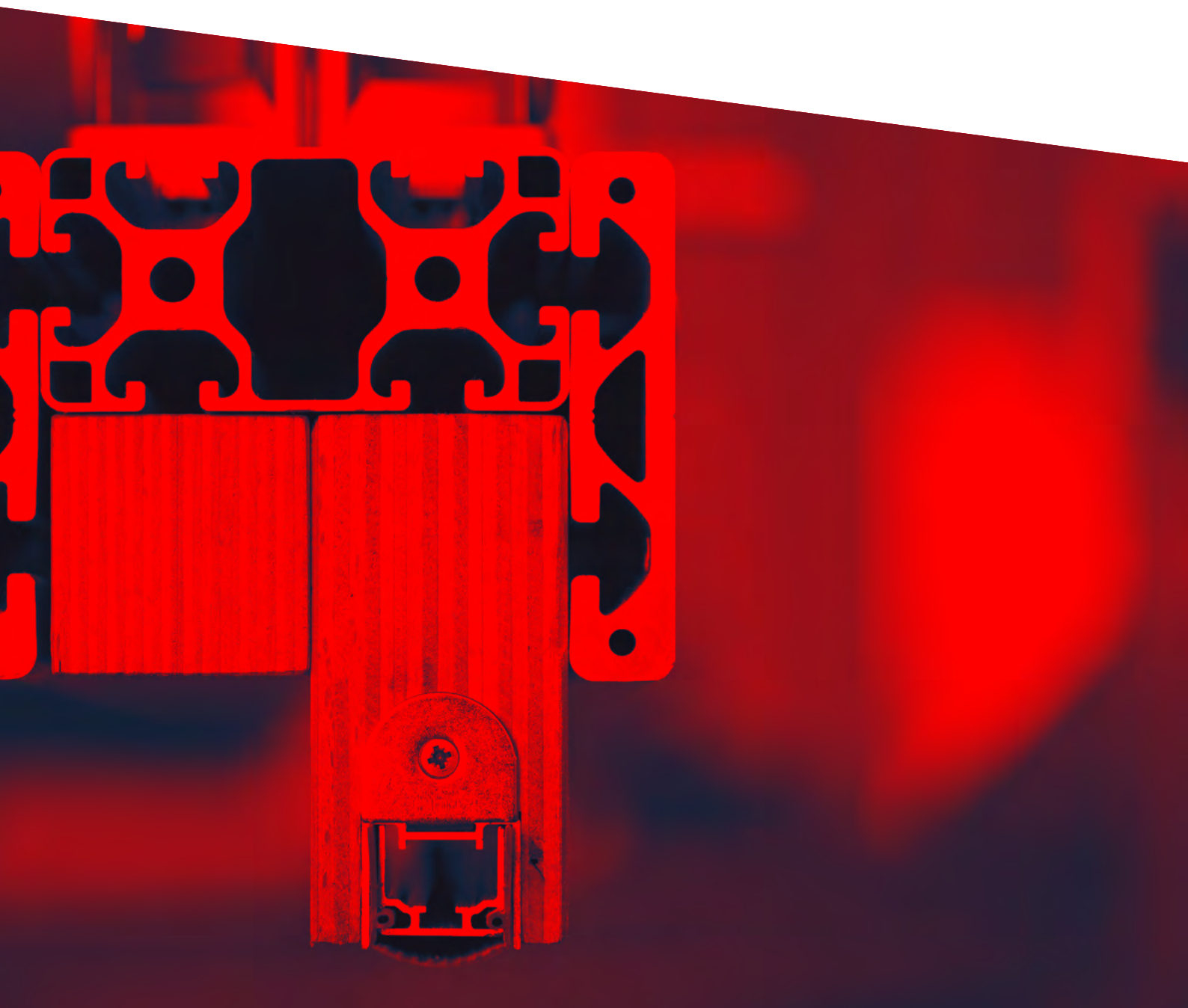



# Stadi M-17/17 WS

## 1-937

- / the modular system door seal
- / parallel drop minimises friction with the floor
- / tool-free actuator can be deactivated before building occupancy
- / actuator requires no protective press plate for the frame
- / overload protection protects seal from excessive wear



### TECHNICAL DATA

Application	hinged timber & metal & PVC doors
Actuation	single
Gasket material	self-extinguishing silicone

### DIMENSIONS

Width x height	17 x 17 mm
Standard lengths	750, 900, 1050, 1200 mm
Minimum lengths*	250 mm
Maximum lengths	2000 mm
Can be shortened by	150 mm from standard lengths
Travel	13 mm

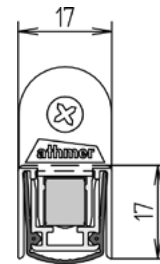

### FIXING/MONTAGE

Fixing	into the chamber at underside of the door, screw fixed either side
Accessories included with delivery	5104

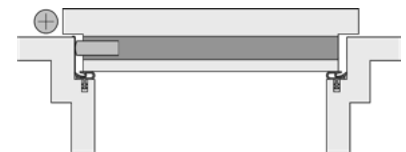

### PERFORMANCE & CERTIFICATES

Fire	UL10B & UL10C (R38166)
Acoustic	52dB over 12mm gap

\* min. lengths cannot be shortened



# Stadi MD-17/17 WS

## 1-950

- / the modular system door seal
- / parallel drop minimises friction with the floor
- / tool-free actuator can be deactivated before building occupancy
- / actuator requires no protective press plate for the frame
- / overload protection protects seal from excessive wear



### TECHNICAL DATA

Application	hinged timber & metal & PVC doors
Actuation	single, delayed actuation
Gasket material	self-extinguishing silicone

### DIMENSIONS

Width x height	17 x 17 mm
Standard lengths	750, 900, 1050, 1200 mm
Minimum lengths*	655 mm
Maximum lengths	2000 mm
Can be shortened by	150 mm from standard lengths
Travel	13 mm

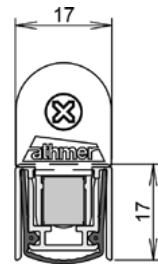

### FIXING/MONTAGE

Fixing	into the chamber at underside of the door, screw fixed either side
Accessories included with delivery	5428

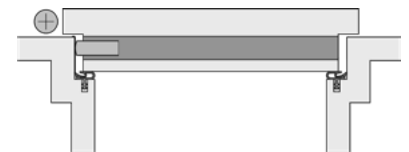

### PERFORMANCE & CERTIFICATES

Fire	UL10B & UL10C (R38166)
Acoustic	52dB over 12mm gap

\* min. lengths cannot be shortened

2 Drop seals  
2.1 rebated drop seals for hinged doors

athmer.com







# Stadi L-17/20 WS

## 1-940

- / the modular system door seal
- / parallel drop minimises friction with the floor
- / tool-free actuator can be deactivated before building occupancy
- / actuator requires no protective press plate for the frame
- / overload protection protects seal from excessive wear



### TECHNICAL DATA

Application	hinged timber & metal & PVC doors
Actuation	single
Gasket material	self-extinguishing silicone

### DIMENSIONS

Width x height	17 x 20 mm
Standard lengths	750, 900, 1050, 1200 mm
Minimum lengths*	250 mm
Maximum lengths	2000 mm
Can be shortened by	150 mm from standard lengths
Travel	16 mm



### FIXING/MONTAGE

Fixing	into the chamber at underside of the door, screw fixed either side
Accessories included with delivery	5104

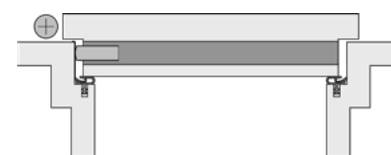

### PERFORMANCE & CERTIFICATES

Fire	UL10B & UL10C [R38166]
Acoustic	52dB over 7mm gap, 51dB over 12mm gap
Smoke	Certifire TS21 [CF 5675]

\* min. lengths cannot be shortened



# Stadi LD-17/20 WS

## 1-953

- / the modular system door seal
- / parallel drop minimises friction with the floor
- / tool-free actuator can be deactivated before building occupancy
- / actuator requires no protective press plate for the frame
- / overload protection protects seal from excessive wear



### TECHNICAL DATA

Application	hinged timber & metal & PVC doors
Actuation	single, delayed actuation
Gasket material	self-extinguishing silicone

### DIMENSIONS

Width x height	17 x 20 mm
Standard lengths	750, 900, 1050, 1200 mm
Minimum lengths*	655 mm
Maximum lengths	1600 mm
Can be shortened by	150 mm from standard lengths
Travel	16 mm



### FIXING/MONTAGE

Fixing	into the chamber at underside of the door, screw fixed either side
Accessories included with delivery	5428

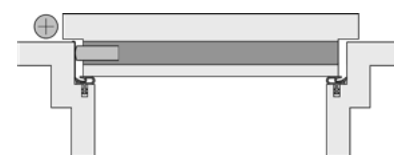

### PERFORMANCE & CERTIFICATES

Fire	UL10B & UL10C (R38166)
Acoustic	52dB over 7mm gap, 51dB over 12mm gap
Smoke	Certifire TS21 (CF 5675)

\* min. lengths cannot be shortened



# Stadi L-20/20 WS

## 1-939

- / the modular system door seal
- / parallel drop minimises friction with the floor
- / tool-free actuator can be deactivated before building occupancy
- / actuator requires no protective press plate for the frame
- / overload protection protects seal from excessive wear



### TECHNICAL DATA

Application	hinged timber & metal & PVC doors
Actuation	single
Gasket material	self-extinguishing silicone

### DIMENSIONS

Width x height	20 x 20 mm
Standard lengths	750, 900, 1050, 1200 mm
Minimum lengths*	230 mm
Maximum lengths	2000 mm
Can be shortened by	150 mm from standard lengths
Travel	16 mm

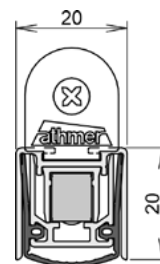

### FIXING/MONTAGE

Fixing	into the chamber at underside of the door, screw fixed either side
Accessories included with delivery	5104

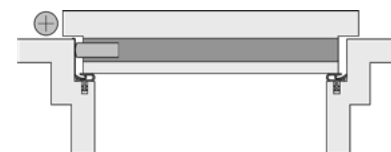

### PERFORMANCE & CERTIFICATES

Fire	UL10B & UL10C (R38166)
Acoustic	52dB over 12mm gap
Smoke	Certifire TS21 (CF 5675)

\* min. lengths cannot be shortened



# Stadi LD-20/20 WS

## 1-952

- / the modular system door seal
- / parallel drop minimises friction with the floor
- / tool-free actuator can be deactivated before building occupancy
- / actuator requires no protective press plate for the frame
- / overload protection protects seal from excessive wear



### TECHNICAL DATA

Application	hinged timber & metal & PVC doors
Actuation	single, delayed actuation
Gasket material	self-extinguishing silicone

### DIMENSIONS

Width x height	20 x 20 mm
Standard lengths	750, 900, 1050, 1200 mm
Minimum lengths*	635 mm
Maximum lengths	1600 mm
Can be shortened by	150 mm from standard lengths
Travel	16 mm

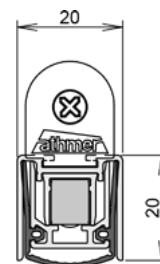

### FIXING/MONTAGE

Fixing	into the chamber at underside of the door, screw fixed either side
Accessories included with delivery	5428

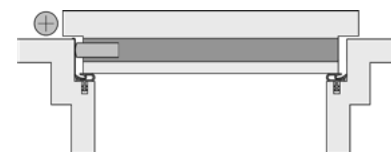

### PERFORMANCE & CERTIFICATES

Fire	UL10B & UL10C (R38166)
Acoustic	52dB over 12mm gap
Smoke	Certifire TS21 (CF 5675)

\* min. lengths cannot be shortened

2 Drop seals  
2.1 rebated drop seals for hinged doors

athmer.com

# Stadi L-20/20 OS

## 1-972

- / the modular system door seal
- / parallel drop minimises friction with the floor
- / tool-free actuator can be deactivated before building occupancy
- / actuator requires no protective press plate for the frame
- / overload protection protects seal from excessive wear



### TECHNICAL DATA

Application	hinged timber & metal & PVC doors
Actuation	single
Gasket material	self-extinguishing silicone

### DIMENSIONS

Width x height	20 x 20 mm
Standard lengths	750, 900, 1050, 1200 mm
Minimum lengths*	635 mm
Maximum lengths	1600 mm
Can be shortened by	150 mm from standard lengths
Travel	16 mm

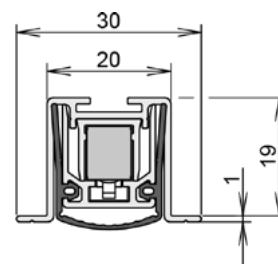

### FIXING/MONTAGE

Fixing	screw fixed into the chamber at the underside of the door
Accessories included with delivery	5503

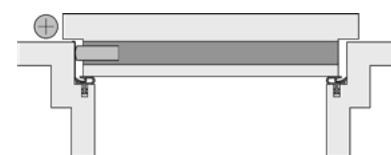

### PERFORMANCE & CERTIFICATES

Acoustic	52dB over 12mm gap
----------	--------------------

\* min. lengths cannot be shortened

# Stadi LD-20/20 OS

## 1-985

- / the modular system door seal
- / parallel drop minimises friction with the floor
- / tool-free actuator can be deactivated before building occupancy
- / actuator requires no protective press plate for the frame
- / overload protection protects seal from excessive wear



### TECHNICAL DATA

Application	hinged timber & metal & PVC doors
Actuation	single, delayed actuation
Gasket material	self-extinguishing silicone

### DIMENSIONS

Width x height	20 x 20 mm
Standard lengths	750, 900, 1050, 1200 mm
Minimum lengths*	635 mm
Maximum lengths	1600 mm
Can be shortened by	150 mm from standard lengths
Travel	16 mm

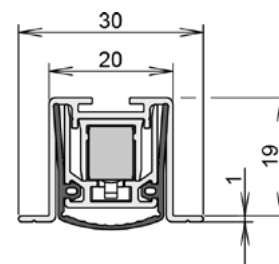

### FIXING/MONTAGE

Fixing	screw fixed into the chamber at the underside of the door
Accessories included with delivery	5503

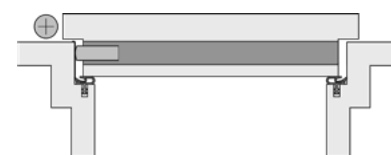

### PERFORMANCE & CERTIFICATES

Acoustic	52dB over 12mm gap
----------	--------------------

\* min. lengths cannot be shortened

2 Drop seals  
2.1 rebated drop seals for hinged doors

athmer.com



# Stadi L-24/20 WS

## 1-938

- / the modular system door seal
- / parallel drop minimises friction with the floor
- / tool-free actuator can be deactivated before building occupancy
- / actuator requires no protective press plate for the frame
- / overload protection protects seal from excessive wear



### TECHNICAL DATA

Application	hinged timber & metal & PVC doors
Actuation	single
Gasket material	self-extinguishing silicone

### DIMENSIONS

Width x height	24 x 20 mm
Standard lengths	750, 900, 1050, 1200 mm
Minimum lengths*	230 mm
Maximum lengths	2000 mm
Can be shortened by	150 mm from standard lengths
Travel	16 mm



### FIXING/MONTAGE

Fixing	into the chamber at underside of the door, screw fixed either side
Accessories included with delivery	5302

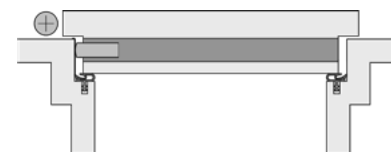

### PERFORMANCE & CERTIFICATES

Fire	UL10B & UL10C (R38166)
Acoustic	54dB over 7mm gap, 51dB over 12mm gap
Smoke	Certifire TS21 (CF 5675)

\* min. lengths cannot be shortened



# Stadi LD-24/20 WS

## 1-951

- / the modular system door seal
- / parallel drop minimises friction with the floor
- / tool-free actuator can be deactivated before building occupancy
- / actuator requires no protective press plate for the frame
- / overload protection protects seal from excessive wear



### TECHNICAL DATA

Application	hinged timber & metal & PVC doors
Actuation	single, delayed actuation
Gasket material	self-extinguishing silicone

### DIMENSIONS

Width x height	24 x 20 mm
Standard lengths	750, 900, 1050, 1200 mm
Minimum lengths*	635 mm
Maximum lengths	1600 mm
Can be shortened by	150 mm from standard lengths
Travel	16 mm



### FIXING/MONTAGE

Fixing	into the chamber at underside of the door, screw fixed either side
Accessories included with delivery	5427

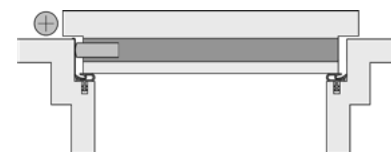

### PERFORMANCE & CERTIFICATES

Fire	UL10B & UL10C (R38166)
Acoustic	54dB over 7mm gap, 51dB over 12mm gap
Smoke	Certifire TS21 (CF 5675)

\* min. lengths cannot be shortened

2 Drop seals  
2.1 rebated drop seals for hinged doors





# Stadi L-24/20 OS

## 1-959

- / the modular system door seal
- / parallel drop minimises friction with the floor
- / tool-free actuator can be deactivated before building occupancy
- / actuator requires no protective press plate for the frame
- / overload protection protects seal from excessive wear



### TECHNICAL DATA

Application	hinged timber & metal & PVC doors
Actuation	single
Gasket material	self-extinguishing silicone

### DIMENSIONS

Width x height	24 x 20 mm
Standard lengths	750, 900, 1050, 1200 mm
Minimum lengths*	230 mm
Maximum lengths	3000 mm
Can be shortened by	150 mm from standard lengths
Travel	16 mm

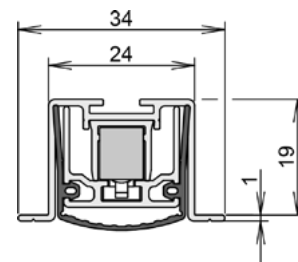

### FIXING/MONTAGE

Fixing	screw fixed into the chamber at the underside of the door
Accessories included with delivery	5503

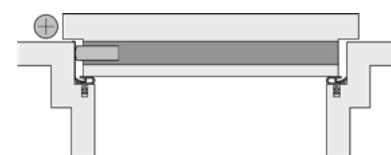

### PERFORMANCE & CERTIFICATES

Fire	UL10B & UL10C (R38166)
Acoustic	54dB over 7mm gap, 51dB over 12mm gap
Smoke	Certifire TS21 (CF 5675)

\* min. lengths cannot be shortened

# Stadi LD-24/20 OS

## 1-1025

- / the modular system door seal
- / parallel drop minimises friction with the floor
- / tool-free actuator can be deactivated before building occupancy
- / actuator requires no protective press plate for the frame
- / overload protection protects seal from excessive wear



### TECHNICAL DATA

Application	hinged timber & metal & PVC doors
Actuation	single, delayed actuation
Gasket material	self-extinguishing silicone

### DIMENSIONS

Width x height	24 x 20 mm
Standard lengths	750, 900, 1050, 1200 mm
Minimum lengths*	230 mm
Maximum lengths	3000 mm
Can be shortened by	150 mm from standard lengths
Travel	16 mm

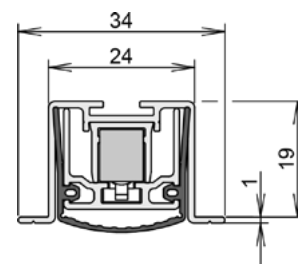

### FIXING/MONTAGE

Fixing	screw fixed into the chamber at the underside of the door
Accessories included with delivery	5503

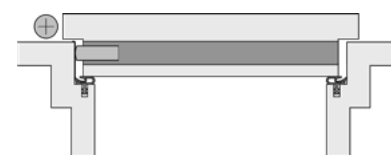

### PERFORMANCE & CERTIFICATES

Acoustic	54dB over 7mm gap, 51dB over 12mm gap
----------	---------------------------------------

\* min. lengths cannot be shortened

2 Drop seals  
2.1 rebated drop seals for hinged doors

athmer.com



# Stadi L-24/20 TS

## 1-960

- / the modular system door seal
- / parallel drop minimises friction with the floor
- / tool-free actuator can be deactivated before building occupancy
- / actuator requires no protective press plate for the frame
- / overload protection protects seal from excessive wear



### TECHNICAL DATA

Application	hinged metal & PVC doors
Actuation	single
Gasket material	self-extinguishing silicone

### DIMENSIONS

Width x height	38 x 20 mm
Standard lengths	750, 900, 1050, 1200 mm
Minimum lengths*	230 mm
Maximum lengths	3000 mm
Can be shortened by	150 mm from standard lengths
Travel	16 mm

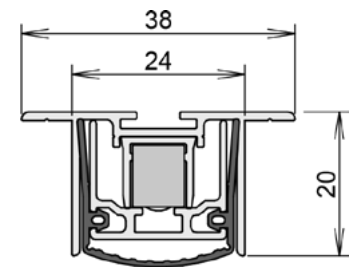

### FIXING/MONTAGE

Fixing	screw fixed into the chamber at the underside of the door
Accessories included with delivery	5503

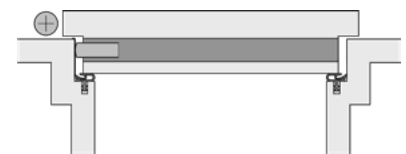

### PERFORMANCE & CERTIFICATES

Fire	UL10B & UL10C (R38166)
Acoustic	54dB over 7mm gap, 51dB over 12mm gap

\* min. lengths cannot be shortened

# Stadi LD-24/20 TS

## 1-1026

- / the modular system door seal
- / parallel drop minimises friction with the floor
- / tool-free actuator can be deactivated before building occupancy
- / actuator requires no protective press plate for the frame
- / overload protection protects seal from excessive wear



### TECHNICAL DATA

Application	hinged metal & PVC doors
Actuation	single, delayed actuation
Gasket material	self-extinguishing silicone

### DIMENSIONS

Width x height	38 x 20 mm
Standard lengths	750, 900, 1050, 1200 mm
Minimum lengths*	230 mm
Maximum lengths	3000 mm
Can be shortened by	150 mm from standard lengths
Travel	16 mm

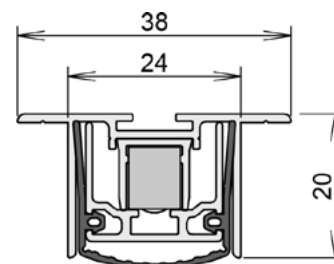

### FIXING/MONTAGE

Fixing	screw fixed into the chamber at the underside of the door
Accessories included with delivery	5503

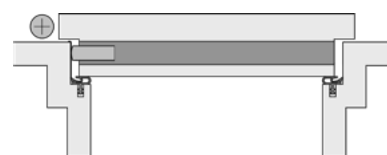

### PERFORMANCE & CERTIFICATES

Acoustic	54dB over 7mm gap, 51dB over 12mm gap
----------	---------------------------------------

\* min. lengths cannot be shortened

# Rainstop® L-24/20 WS

## 1-955

- / weatherproof drop seal
- / air permeability tested (EN 12207)
- / resistance to driving rain (EN 12208)
- / resistance to wind load (EN 12210)



### TECHNICAL DATA

Application	hinged timber & metal & PVC doors
Actuation	single
Gasket material	self-extinguishing silicone

### DIMENSIONS

Width x height	24 x 20 mm
Standard lengths	900, 975, 1050, 1125, 1200, 1275, 1350, 1425, 1500 mm
Minimum lengths*	230 mm
Maximum lengths	2000 mm
Can be shortened by	150 mm from standard lengths
Travel	16 mm

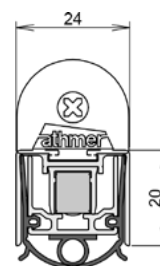

### FIXING/MONTAGE

Fixing	rebated into a groove in the door, screw fixed either side
Accessories included with delivery	5475

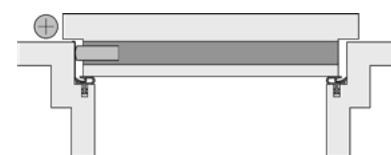

### PERFORMANCE & CERTIFICATES

Acoustic	54dB over 7mm gap
----------	-------------------

\* min. lengths cannot be shortened

# Stadi XL-40 ST

1-477



## TECHNICAL DATA

Application	hinged metal gates, sliding metal gates
Actuation	single
Gasket material	self-extinguishing silicone

## DIMENSIONS

Width x height	28,5 x 40 mm
Standard lengths	750, 900, 1050, 1200 mm
Minimum lengths*	600 mm
Maximum lengths	8000 mm
Can be shortened by	125 mm
Travel	20 mm

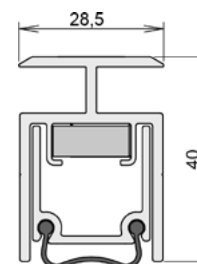

## FIXING/MONTAGE

Fixing	surface mounted to the face of the door, screw fixed
Accessories included with delivery	5962

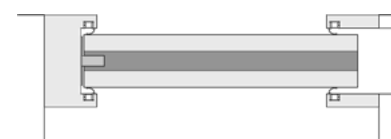

\* min. lengths cannot be shortened

2 Drop seals  
2.1 rebated drop seals for hinged doors

athmer.com



# M-24/20 WS

## 1-264

/ the classic drop seal for aluminum, steel and PVC doors



### TECHNICAL DATA

Application	hinged metal & PVC doors
Actuation	single
Gasket material	self-extinguishing silicone

### DIMENSIONS

Width x height	24 x 20 mm
Standard lengths	customized
Minimum lengths*	220 mm
Maximum lengths	2000 mm
Can be shortened by	125 mm, smallest product length that can be shortened: 676 mm
Travel	11 mm

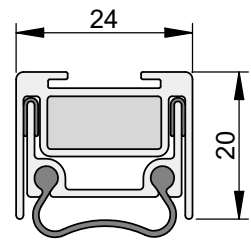

### FIXING/MONTAGE

Fixing	into the chamber at the underside of the door, screw fixed either side
Accessories included with delivery	S007

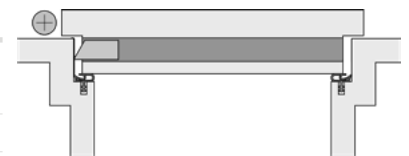

### PERFORMANCE & CERTIFICATES

Fire	UL 10C [R38166]
Acoustic	44dB over 7mm gap, 42dB over 10mm gap

\* min. lengths cannot be shortened



# M-24/21 OS

## 1-244

/ the classic drop seal for aluminum, steel and PVC doors



### TECHNICAL DATA

Application	hinged metal & PVC doors
Actuation	single
Gasket material	self-extinguishing silicone

### DIMENSIONS

Width x height	24 x 21 mm
Standard lengths	customized
Minimum lengths*	220 mm
Maximum lengths	2900 mm
Can be shortened by	125 mm, smallest product length that can be shortened: 676 mm
Travel	11 mm

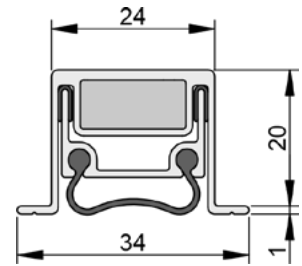

### FIXING/MONTAGE

Fixing	screw fixed into the chamber at the underside of the door
Accessories included with delivery	S008

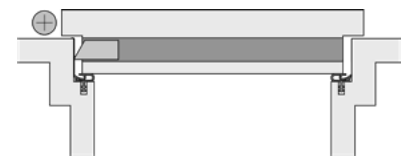

### PERFORMANCE & CERTIFICATES

Fire	UL 10C [R38166]
Acoustic	44dB over 7mm gap, 42dB over 10mm gap

\* min. lengths cannot be shortened

2 Drop seals  
2.1 rebated drop seals for hinged doors

athmer.com





# M-24/20 TS

## 1-248

/ the classic drop seal for aluminum, steel and PVC doors



### TECHNICAL DATA

Application	hinged metal & PVC doors
Actuation	single
Gasket material	self-extinguishing silicone

### DIMENSIONS

Width x height	40 x 20 mm
Standard lengths	customized
Minimum lengths*	220 mm
Maximum lengths	2900 mm
Can be shortened by	125 mm, smallest product length that can be shortened: 676 mm
Travel	11 mm

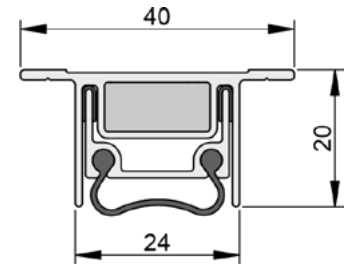

### FIXING/MONTAGE

Fixing	screw fixed into the chamber at the underside of the door
Accessories included with delivery	S008

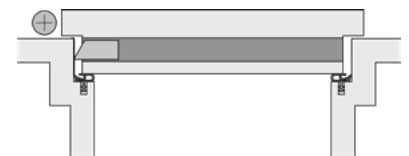

### PERFORMANCE & CERTIFICATES

Fire	UL 10C [R38166]
Acoustic	44dB over 7mm gap, 42dB over 10mm gap

\* min. lengths cannot be shortened

# Schall-Ex® Jumbo I

## 1-154

- / drop seal for extreme under-door gaps
- / covers gaps up to 35mm
- / ideal for listed buildings where maintenance is limited



### TECHNICAL DATA

Application	hinged timber & metal door, hinged timber & metal gates
Actuation	single
Gasket material	self-extinguishing silicone

### DIMENSIONS

Width x height	19,5 x 50 mm
Standard lengths	708, 833, 958, 1083, 1208 mm
Minimum lengths*	450 mm
Maximum lengths	1700 mm
Can be shortened by	60 mm from standard lengths
Travel	35 mm

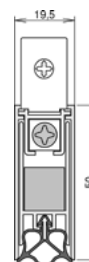

### FIXING/MONTAGE

Fixing	rebated into a groove in the door, screw fixed either side
Accessories included with delivery	5400

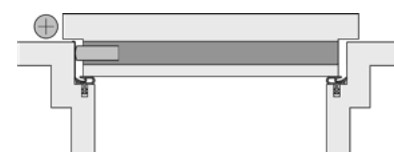

\* min. lengths cannot be shortened

**2 Drop seals**  
2.1 rebated drop seals for hinged doors

athmer.com

Drop seals  
for sliding timber, metal & glass doors

# Smart solutions for space-efficient doors

Our range of sliding door drop seals has been designed with the specific requirements of sliding doors in mind. **Unique design features** like a flat-faced actuator and a low-pressure mechanism are better suited to the door's closing movement, maintaining low door operating forces and supporting long-term durability. There are options for both latched and unlatched sliding doors, with unlatched door options consisting of an integrated magnet for keeping the door closed and sealed. We also supply complete sliding door solutions, including an innovative four-sided seal for comprehensive performance.

The seal drops automatically when the door is closed to **form a seal with the floor**, retracting when the door is opened to ensure the door operation is unhindered. This section covers sliding door solutions for timber, system and glass door leaf materials. Their main purpose is to provide an effective barrier against sound transfer at the door threshold, as well as smoke, air, light, dirt, dust, insects and odours.



## Drop seals

for sliding timber, metal & glass doors, and pivot doors

# Schall-Ex® Slide M-12 WS

## 1-548

- / latched sliding door drop seal
- / flat-faced actuator with low activation pressure



### TECHNICAL DATA

Application	sliding timber doors
Actuation	single
Gasket material	self-extinguishing silicone

### DIMENSIONS

Width x height	12 x 35 mm
Standard lengths	708, 833, 958, 1083, 1208 mm
Minimum lengths*	280 mm
Maximum lengths	1958 mm
Can be shortened by	125 mm from standard lengths
Travel	11 mm

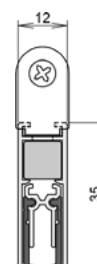

### FIXING/MONTAGE

Fixing	rebated into a groove in the door, screw fixed either side
Accessories included with delivery	5113



### PERFORMANCE & CERTIFICATES

Acoustic	49dB over 7mm gap, 46dB over 10mm gap
----------	---------------------------------------

\* min. lengths cannot be shortened

# Schall-Ex® Slide & Lock M-12 WS

## 1-549

- / unlatched sliding door drop seal
- / flat-faced actuator with low activation pressure
- / integrated magnet for doors without latch or lock



### TECHNICAL DATA

Application	sliding timber doors
Actuation	single
Gasket material	self-extinguishing silicone

### DIMENSIONS

Width x height	12 x 35 mm
Standard lengths	708, 833, 958, 1083, 1208 mm
Minimum lengths*	280 mm
Maximum lengths	1958 mm
Can be shortened by	125 mm from standard lengths
Travel	11 mm

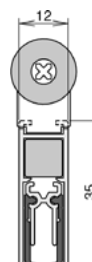

### FIXING/MONTAGE

Fixing	rebated into a groove in the door, screw fixed either side
Accessories included with delivery	5105

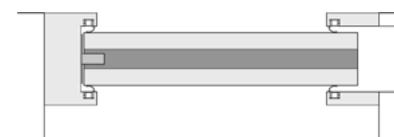

### PERFORMANCE & CERTIFICATES

Acoustic	49dB over 7mm gap, 46dB over 10mm gap
----------	---------------------------------------

\* min. lengths cannot be shortened

# Schall-Ex® Slide & Lock L-24/20 WS

**1-965**

/ sliding system door drop seal



## TECHNICAL DATA

Application	sliding timber & metal & PVC doors
Actuation	single
Gasket material	self-extinguishing silicone

## DIMENSIONS

Width x height	24 x 20 mm
Standard lengths	708, 833, 958, 1083, 1208 mm
Minimum lengths*	485 mm
Maximum lengths	2000 mm
Can be shortened by	150 mm from standard lengths
Travel	16 mm

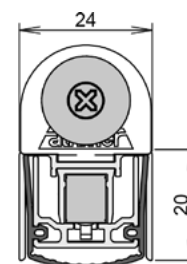

## FIXING/MONTAGE

Fixing	rebated into a groove in the door, screw fixed either side
Accessories included with delivery	5426



## PERFORMANCE & CERTIFICATES

Acoustic	54dB over 7mm gap, 51dB over 12mm gap
----------	---------------------------------------

\* min. lengths cannot be shortened

# Slide L-15/38 WS

**1-177**

/ latched sliding door drop seal



## TECHNICAL DATA

Application	sliding timber doors
Actuation	single
Gasket material	self-extinguishing silicone

## DIMENSIONS

Width x height	14,8 x 38 mm
Standard lengths	customized
Minimum lengths*	300 mm
Maximum lengths	1700 mm
Can be shortened by	125 mm, smallest product length that can be shortened: 461 mm
Travel	20 mm

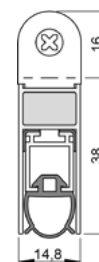

## FIXING/MONTAGE

Fixing	rebated into a groove in the door, screw fixed either side
Accessories included with delivery	S002

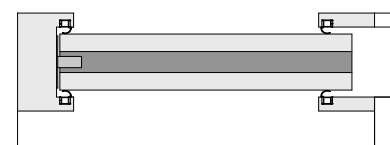

## PERFORMANCE & CERTIFICATES

Fire	EN 1634-1**
Acoustic	43dB over 7mm gap, 42dB over 10mm gap, 39dB over 15mm gap

\* min. lengths cannot be shortened

\*\*The test value may differ according to the EN 1634-1 test, as the complete door system must be checked.



# Slide M-24/20 WS

**1-473**

/ sliding system door drop seal

/ flat-faced actuator



## TECHNICAL DATA

Application	sliding metal doors
Actuation	single
Gasket material	self-extinguishing silicone

## DIMENSIONS

Width x height	24 x 20 mm
Standard lengths	customized
Minimum lengths*	220 mm
Maximum lengths	2000 mm
Can be shortened by	125 mm, smallest product length that can be shortened: 676 mm
Travel	11 mm

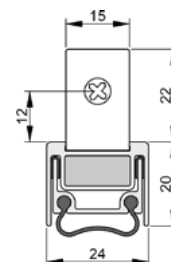

## FIXING/MONTAGE

Fixing	into the chamber at the underside of the door, screw fixed either side
Accessories included with delivery	S007

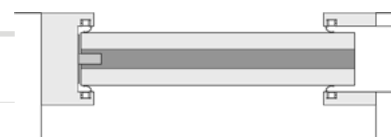

## PERFORMANCE & CERTIFICATES

Acoustic	44dB over 7mm gap, 42dB over 10mm gap
----------	---------------------------------------

\* min. lengths cannot be shortened

# Slide M-24/21 OS

## 1-471

- / sliding system door drop seal
- / flat-faced actuator

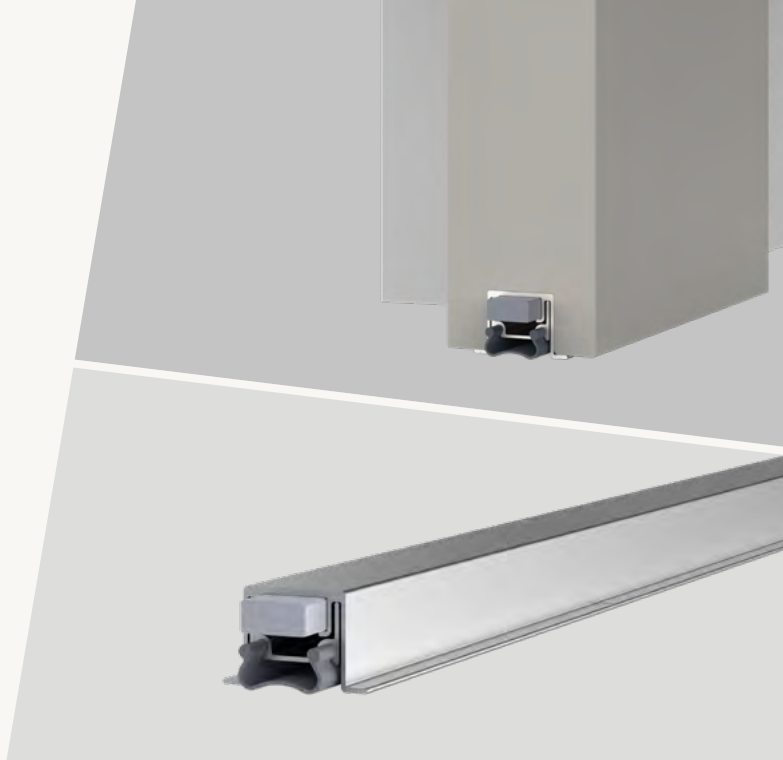

### TECHNICAL DATA

Application	sliding metal doors
Actuation	single
Gasket material	self-extinguishing silicone

### DIMENSIONS

Width x height	24 x 21 mm
Standard lengths	customized
Minimum lengths*	220 mm
Maximum lengths	2900 mm
Can be shortened by	125 mm, smallest product length that can be shortened: 676 mm
Travel	11 mm

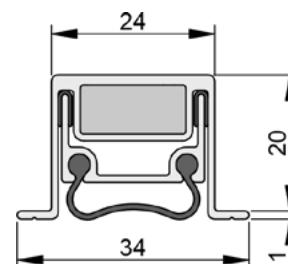

### FIXING/MONTAGE

Fixing	screw fixed into the chamber at the underside of the door
Accessories included with delivery	S008

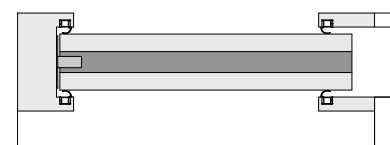

### PERFORMANCE & CERTIFICATES

Acoustic	44dB over 7mm gap, 42dB over 10mm gap
----------	---------------------------------------

\* min. lengths cannot be shortened

# Slide M-24/20 TS

**1-472**

- / sliding system door drop seal
- / flat-faced actuator



## TECHNICAL DATA

Application	sliding metal doors
Actuation	single
Gasket material	self-extinguishing silicone

## DIMENSIONS

Width x height	40 x 20 mm
Standard lengths	customized
Minimum lengths*	220 mm
Maximum lengths	2900 mm
Can be shortened by	125 mm, smallest product length that can be shortened: 676 mm
Travel	11 mm

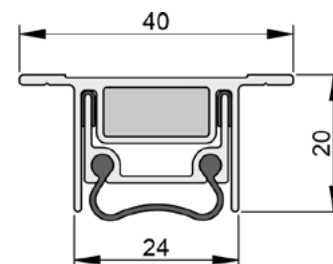

## FIXING/MONTAGE

Fixing	screw fixed into the chamber at the underside of the door
Accessories included with delivery	S008

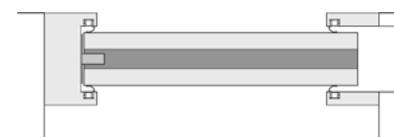

## PERFORMANCE & CERTIFICATES

Acoustic	44dB over 7mm gap, 42dB over 10mm gap
----------	---------------------------------------

\* min. lengths cannot be shortened

# Schall-Ex® Slide Radiation Protection M-20 WS

**1-557**

/ radiation-resistant drop seal for sliding doors



## TECHNICAL DATA

Application	sliding timber doors
Actuation	single
Gasket material	silicone self-extinguishing, lead rubber

## DIMENSIONS

Width x height	19,7 x 30 mm
Standard lengths	708, 833, 958, 1083, 1208 mm
Minimum lengths*	220 mm
Maximum lengths	2000 mm
Can be shortened by	125 mm
Travel	12 mm

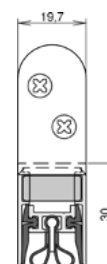

## FIXING/MONTAGE

Fixing	rebated into a groove in the door, screw fixed either side
Accessories included with delivery	5114

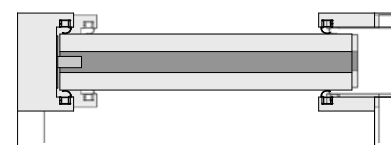

**2 Drop seals**  
2.2 drop seals for sliding doors

athmer.com

\* min. lengths cannot be shortened

# Schall-Ex® Slide Radiation Protection M-20 OS

**1-554**

/ radiation-resistant drop seal for sliding doors



## TECHNICAL DATA

Application	sliding timber doors
Actuation	single
Gasket material	silicone, lead rubber

## DIMENSIONS

Width x height	19,7 x 30 mm
Standard lengths	708, 833, 958, 1083, 1208 mm
Minimum lengths*	220 mm
Maximum lengths	2000 mm
Can be shortened by	125 mm
Travel	12 mm

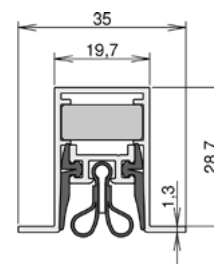

## FIXING/MONTAGE

Fixing	rebated into a groove in the door, screw fixed to the underside
Accessories included with delivery	5111

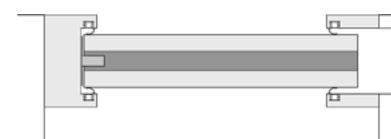

\* min. lengths cannot be shortened



# Schall-Ex® L-15 Pivot

## 1-946

- / pivot hinge door drop seal
- / suitable with single-acting pivot doors
- / ground-breaking roller actuator suitable for various frame designs

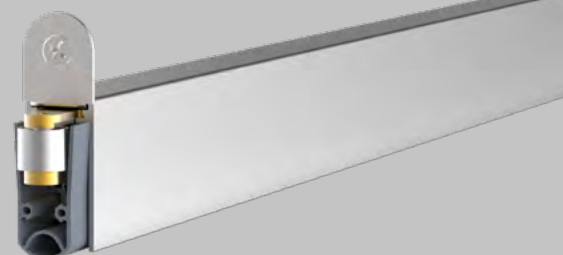

### TECHNICAL DATA

Application	hinged timber doors, doors with pivot hinges
Gasket material	self-extinguishing silicone

### DIMENSIONS

Width x height	15 x 30 mm
Standard lengths	833, 958, 1083, 1208 mm
Minimum lengths*	235 mm
Maximum lengths	2000 mm
Can be shortened by	125 mm from standard lengths
Travel	12 mm

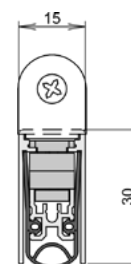

### FIXING/MONTAGE

Fixing	rebated into a groove in the door, screw fixed either side
Accessories included with delivery	5516

### PERFORMANCE & CERTIFICATES

Fire	UL10B & UL10C (R38166)
Acoustic	52dB over 7mm gap
Smoke	Certifire TS21 (CF 5675)

\* min. lengths cannot be shortened

Drop seals  
for hinged glass doors

# Elegant solutions for stylish doors

Our range of drop seals for glass doors has been developed with an **emphasis on the strict aesthetic requirements** demanded by frameless glass construction and with the idea to reduce the seal's visual impact as much as possible. Slimline profiles and clever design traits allow the products to blend seamlessly with the door and its hardware whilst achieving the necessary performance.

The seal drops automatically when the door is closed to form a seal with the floor, retracting when the door is opened to ensure the **door operation is unhindered**. Our range can achieve this with a range of glass thicknesses starting from 6mm. Their main purpose is to provide an effective barrier against sound transfer at the door threshold, as well as smoke, air, light, dirt, dust, insects and odours.



**Drop seals**  
for hinged and sliding glass doors



# Schall-Ex® GS-A

## 1-814 silver-coloured, anod. C-0

- / retrofit glass door drop seal
- / Suitable for new and existing doors with 6mm glass & thicker



### TECHNICAL DATA

Application	hinged glass doors
Actuation	single
Gasket material	self-extinguishing silicone

### DIMENSIONS

Width x height	15 x 44,5 mm
Standard lengths	708, 833, 958, 1083, 1208 mm
Minimum lengths*	235 mm
Maximum lengths	1333 mm
Can be shortened by	125 mm from standard lengths
Travel	11 mm

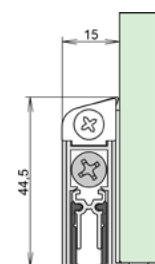

### FIXING/MONTAGE

Fixing	surface-mounted to door, self-adhesive
Accessories included with delivery	5503

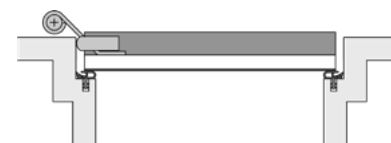

### PERFORMANCE & CERTIFICATES

Acoustic	41dB over 7mm gap, 37dB over 10mm gap
----------	---------------------------------------

### FURTHER VARIANTS

COLORS	ART.NO.
Stainless steel-colored [C-31]	1-815

\* min. lengths cannot be shortened

# Schall-Ex® GS-H10

## 1-453 silver-coloured, anod. C-0

- / architectural glass door drop seal
- / Suitable for new doors with 10mm glass thickness
- / also available with DUO double actuation



### TECHNICAL DATA

Application	hinged glass doors
Actuation	single
Gasket material	self-extinguishing silicone

### DIMENSIONS

Width x height	12,6 x 32 mm
Standard lengths	708, 833, 958, 1083, 1208 mm
Minimum lengths*	235 mm
Maximum lengths	1333 mm
Can be shortened by	125 mm from standard lengths
Travel	11 mm

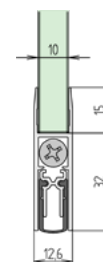

### FIXING/MONTAGE

Fixing	bonded to underside with builder's adhesive (not supplied)
Accessories included with delivery	5503

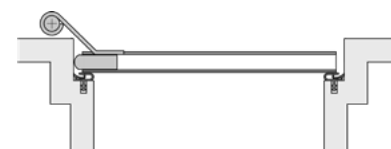

### PERFORMANCE & CERTIFICATES

Acoustic	40dB over 10mm gap
----------	--------------------

### FURTHER VARIANTS

COLORS/ART.NO.	single actuation	double actuation (techn. data may differ)
Silver-coloured, anod. [C-0]	1-453	1-454
Stainless steel-colored [C-31]	1-677	1-676

\* min. lengths cannot be shortened

2 Drop seals  
2.4 drop seals for hinged glass doors

athmer.com

# Schall-Ex® GS-H8/12

**1-817 silver-coloured, anod. C-0**

- / architectural glass door drop seal
- / Suitable for new doors with glass between 8-12mm thick



## TECHNICAL DATA

Application	hinged glass doors
Actuation	single
Gasket material	self-extinguishing silicone

## DIMENSIONS

Width x height	16,6 x 27,3 mm
Standard lengths	708, 833, 958, 1083, 1208 mm
Minimum lengths*	235 mm
Maximum lengths	1333 mm
Can be shortened by	125 mm from standard lengths
Travel	12 mm

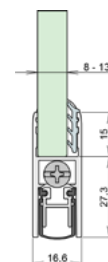

## FIXING/MONTAGE

Fixing	bonded to underside with builder's adhesive (not supplied)
Accessories included with delivery	5550



## PERFORMANCE & CERTIFICATES

Acoustic	40dB over 10mm gap
----------	--------------------

## FURTHER VARIANTS

COLORS	ART.NO.
Stainless steel-colored [C-31]	1-818

\* min. lengths cannot be shortened



# Schall-Ex® Slide GS-A

## 1-875 silver-coloured, anod. C-0

- / retrofit sliding glass door drop seal
- / Suitable for new and existing doors with 6mm glass & thicker
- / flat-faced actuator with low activation pressure



### TECHNICAL DATA

Application	sliding glass doors
Actuation	single
Gasket material	self-extinguishing silicone

### DIMENSIONS

Width x height	15,4 x 45 mm
Standard lengths	708, 833, 958, 1083, 1208 mm
Minimum lengths*	235 mm
Maximum lengths	1958 mm
Can be shortened by	125 mm from standard lengths
Travel/Hub	11 mm

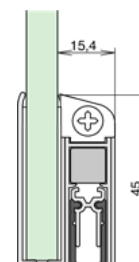

### FIXING/MONTAGE

Fixing	surface-mounted to door, self-adhesive
Accessories included with delivery	5115



### PERFORMANCE & CERTIFICATES

Acoustic	41dB over 7mm gap, 37dB over 10mm gap
----------	---------------------------------------

### FURTHER VARIANTS

COLORS	ART.NO.
Stainless steel-colored [C-31]	1-876

\* min. lengths cannot be shortened

# Schall-Ex® Slide GS-H10

## 1-572 silver-coloured, anod. C-0

- / architectural sliding glass door drop seal
- / Suitable for new doors with 10mm glass thickness
- / flat-faced actuator with low activation pressure



### TECHNICAL DATA

Application	sliding glass doors
Actuation	single
Gasket material	self-extinguishing silicone

### DIMENSIONS

Width x height	12,6 x 32 mm
Standard lengths	708, 833, 958, 1083, 1208 mm
Minimum lengths*	280 mm
Maximum lengths	1605 mm
Can be shortened by	125 mm from standard lengths
Travel/Hub	11 mm

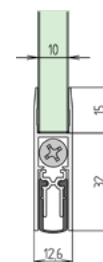

### FIXING/MONTAGE

Fixing	bonded to underside with builder's adhesive (not supplied)
Accessories included with delivery	5115



### PERFORMANCE & CERTIFICATES

Acoustic	40dB over 10mm gap
----------	--------------------

### FURTHER VARIANTS

COLORS	ART.NO.
Stainless steel-colored (C-31)	1-681

\* min. lengths cannot be shortened

2 Drop seals  
2.5 drop seals for sliding glass doors

athmer.com