

2K (Wired) Video Doorbell

QUICK START GUIDE

V1.0.1

* Thanks for purchasing and using our product. Please read this quick start guide before using, and keep it for future reference.

* Manual contents are subject to change without notice in accordance with our policy of continuous product improvement.

Warranty Service

Thank you for purchasing products from **KAMEP**. We distinguish ourselves by an unrelenting commitment to excellence in terms of our reliable quality, robust design and whole-hearted service. All items you bought from **KAMEP** enjoy life-time warranty service.

Should you have any questions in using our products, please feel free to contact us by e-mail. A reply email with solution will reach you within 24 hours.

Your advice and suggestions will be highly appreciated and welcomed.

Email: support@kameplife.com

Whatsapp: [\(+86\) 189-2848-4091](https://wa.me/8618928484091)

Website: www.kameplife.com

1. WHAT'S IN THE BOX

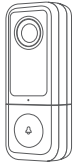

Video Doorbell



20° Angle Mount



Indoor Wireless Chime

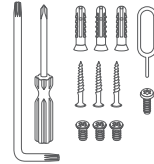

List Tools

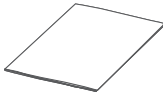

User Guide

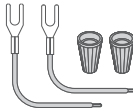

Extension Wire
& Wire Nuts

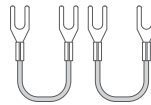

Jumper for
Indoor Chime

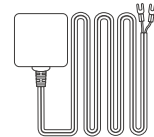

Power Adapter
(DC12V 1A)

2. MEET THE DOORBELL

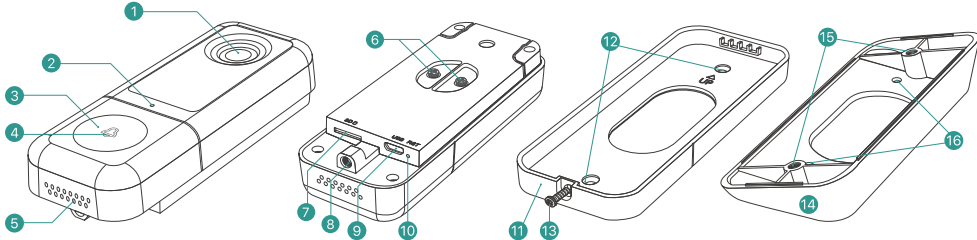

- 1 Camera(2K)
- 2 Microphone
- 3 Doorbell Button
- 4 LED Indicator
- 5 Speakers
- 6 Hardwire Terminals
- 7 MicroSD Slot
- 8 Security Screw Hole
- 9 Micro USB Port
- 10 Reset Hole
- 11 Wall Mount Bracket
- 12 Mounting Screw Holes
- 13 Security Screw
- 14 20° Angle Mount (Optional)
- 15 Doorbell Mounting Holes
- 16 Wall Mounting Screw Holes

3. MEET THE CHIME

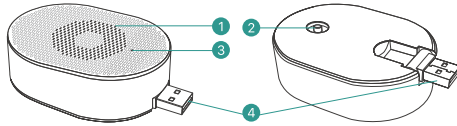

- 1 Speakers
- 2 Reset Button
- 3 LED Indicator
- 4 USB Port (Foldable)

4. SET UP YOUR DOORBELL

- 1 Attach the wires from the provided power adapter to the terminals on the rear of your doorbell, and tighten the terminal screws with screwdriver. **Each wire can be connected to each power terminal. The cable order doesn't matter.**
- 2 Plug the adapter to your AC outlet. Install the doorbell within 30 feet of your 2.4GHz WiFi router. It is suggested to test your doorbell prior to physical installation.

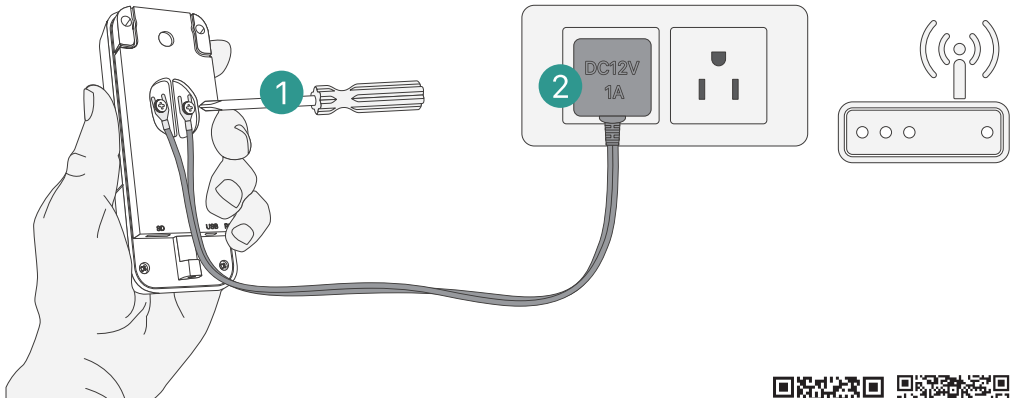

- 3 Download and install the 'CloudEdge' App to your smartphone. Launch the App and register an account with your mobile phone number or email ID.



CloudEdge



iOS



Android

4 Start the Wi-Fi configuration following the in-App instructions or referring to below tutorial steps.

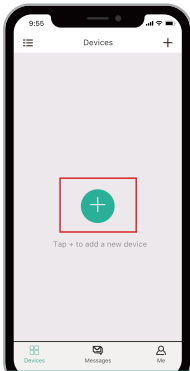

1. Tap "+" to add device

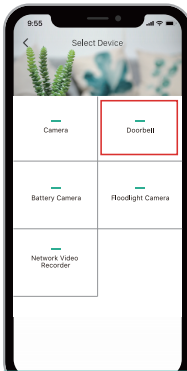

2. Select Doorbell

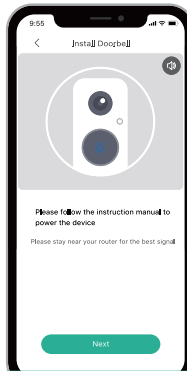

3. Check power status

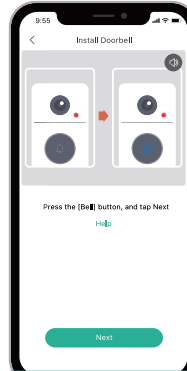

4. Activate the doorbell

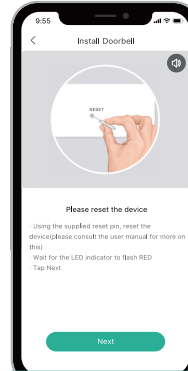

5. Reset device



6. Input Wi-Fi password



7. Prepare Code Scanning



8. Generate QR Code

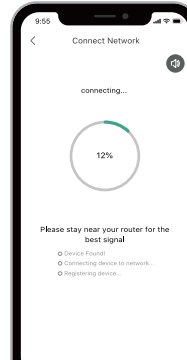



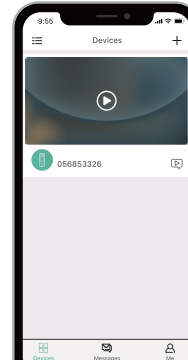



9. Wait for connection



10. Device Added

5 LED indicator explanation:

- | | | | |
|---|--|---|---|
|  | <p>- Solid Red
Device is abnormal.</p> |  | <p>- Solid Blue
Successfully connected to WiFi network.</p> |
|  | <p>- Flashing Red Slowly
Ready for WiFi configuration.</p> |  | <p>- Flashing Blue Quickly
Firmware is upgrading.</p> |
|  | <p>- Flashing Red Quickly
Device is connecting to WiFi.</p> |  | <p>- Nothing
Power failure/
Status light is turned off in doorbell Settings.</p> |

5. LIVE VIEW

Tap  on the Home page devices to watch live view from your doorbell.

- | | |
|-------------------------|--------------------------|
| 1 Quit live viewing | 8 Wi-Fi signal status |
| 2 Setting menu | 9 Screenshot button |
| 3 Date & time watermark | 10 Speak to the scene |
| 4 Volume on/off | 11 Record on the phone |
| 5 FHD/HD/SD switch | 12 Body detection on/off |
| 6 Full screen display | 13 Notification history |
| 7 Stream bit rate | 14 Cloud storage service |

NOTE:

Live viewing will not trigger device recording at **Event recording mode**.

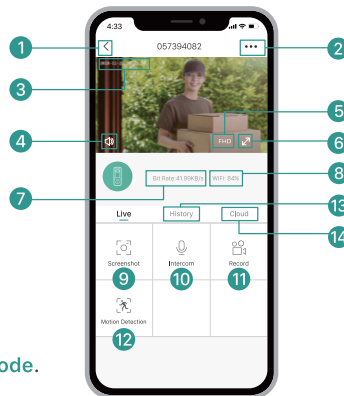

Live view interface

6. SETTINGS

- 1 Back to live view
- 2 Edit device name
- 3 Receive/block motion alarms
- 4 Share device with other users
- 5 Device information
- 6 Basic function:
 1. LED Indicator on/off
 2. Night vision on/off/auto
 3. Human detection frame on/off
 4. Wireless chime settings
- 7 Alarm setting:
 1. Motion detection on/off
 2. Sensitivity Setting
 3. Alarm interval Setting
 4. Alert only when people appear(on/off)
 5. Alarm schedule
 6. Motion detection area setting
- 8 SD Card Setting
- 9 Cloud Storage Service
- 10 Work with Amazon Echo
- 11 Work with Google Home
- 12 Advanced Features: Onvif on/off
- 13 Device Version
- 14 Delete Device

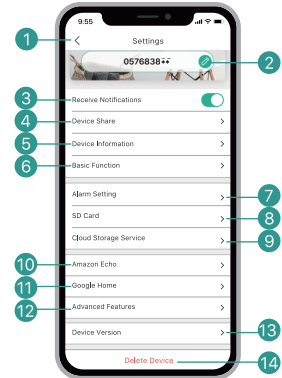

7. RECORDING

Your doorbell comes with **Event recording** by default. It will record visitor calls and motion detection events. You can also enable **Full day recording** in the **Settings** -> **SD Card**.

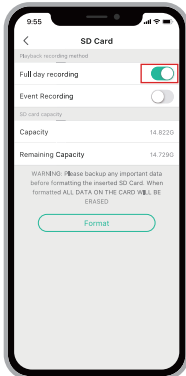

Full Day Recording

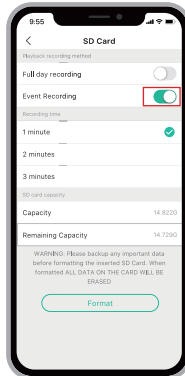

Event Recording

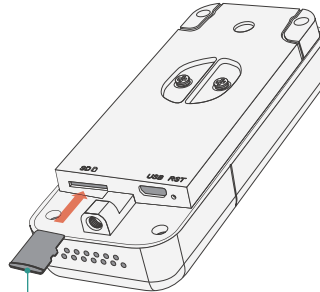

Micro SD Card
Max up to: 128GB

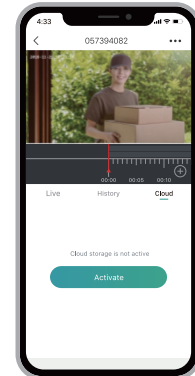

Cloud storage interface

8. HISTORY PLAYBACK

Tap History to play the videos recorded in the MicroSD card.

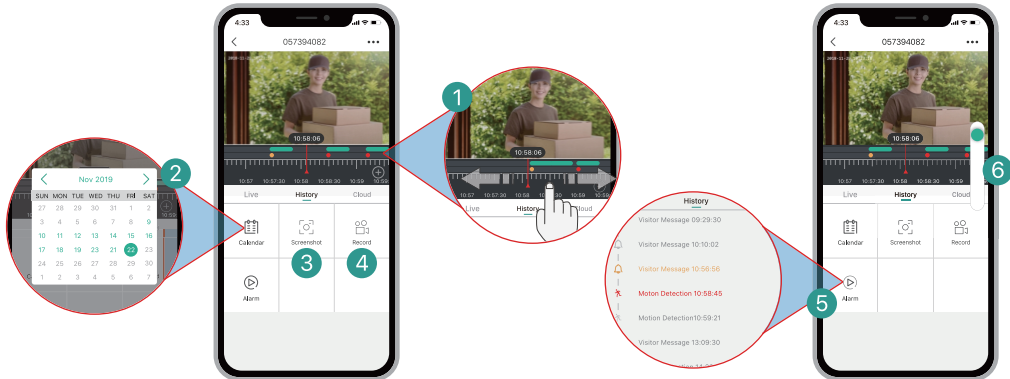

- 1 Time Line:**
Slide the timeline to the left or right to locate video recordings according to time period.
— The green bar stands for video length. • The yellow dot stands for the alarm point when someone has pressed the doorbell button. • The red dot stands for the alarm point when a motion has been detected.
- 2 Calendar:**
Check video history by date. The numbers in green stand for the dates that have video recordings.
- 3 Screenshot:**
Tap to capture a photo and save to **Me -> Pictures & Videos**, Where you can share it to others.
- 4 Record:**
Tap to start recording a video, tap again to end and save to **Me -> Pictures & Videos**, Where you share the video clips to others.
- 5 Alarm:**
Tap the listed alarm records to quickly locate and display each alarm video. 🛎️ Stands for visitor call events; 🔴 stands for motion detection recordings.
- 6 Timeline Zoom:**
Slide upward to zoom in the timeline and downward to zoom out.

9. CONNECT THE CHIME

1 Supply power to the chime

The chime can be powered by USB compatible power source(DC5V 1A), or by the USB port on your computer.

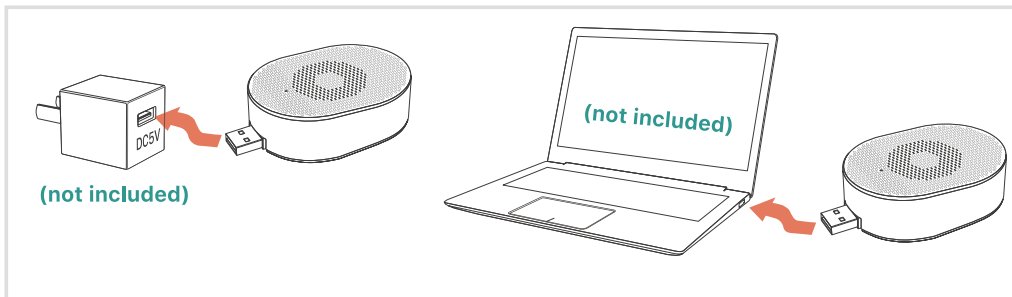

2 Click reset button

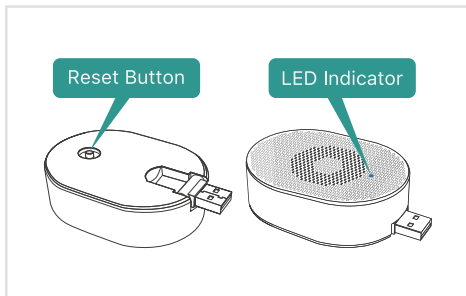

Click on **RESET** only once, and you will see the chime indicator flashing blue, indicating that the chime is in pairing mode.

3 Press the doorbell button

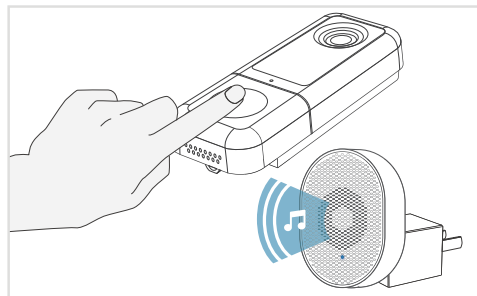

Press the doorbell button, and the chime will sound. If pairing is successful, the indicator on the chime will be in solid blue.

4 Chime settings

You can enter into the chime setting page following below setting steps, so as to mute the Chime Reminder, select ringtones, adjust chime volume or unbind the connection with doorbell.

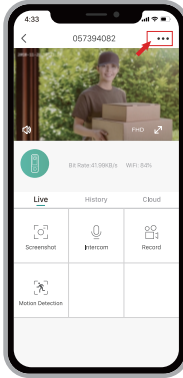

Step.1

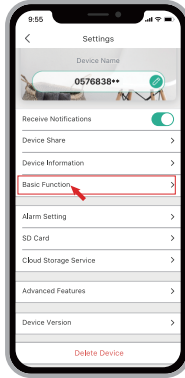

Step.2

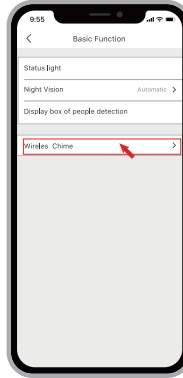

Step.3

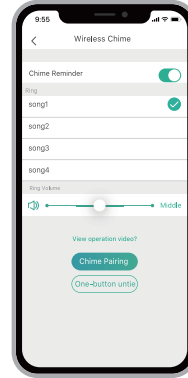

Step.4

NOTE:

1. Your doorbell communicates with the chime via Radio Frequency, but not WiFi.
2. You can assign different chimes as needed.
3. Press and hold **RESET** button on the chime for 5 seconds till the indicator flashes blue 3 times, and you can also release the connection between the chime and its connected doorbell.

10. INSTALLATION

The video doorbell works with **12V DC** power source (power adapter provided), as well as an existing **12V~24V AC** hardwire power source. It enables you to make use of your legacy doorbell wiring for retro-fit installation.

NOTE:

For retro-fit installation, you need to bypass your indoor mechanical chime so as to provide sufficient power for the new video doorbell.

10.1 RETRO-FIT INSTALLATION (OPTIONAL)

To replace your existing doorbell and mechanical chime, please follow below installation steps:

- 1 **Shut off the master circuit breaker in your house.**
- 2 **Bypass your indoor chime with provided jumper.**

In most cases, the existing doorbell circuit looks similar to the image below. Remove the cover of the indoor chime and loosen the "FRONT" and "TRANS" terminal screws. Use the provided jumper to connect the two terminals, and replace the chime cover.

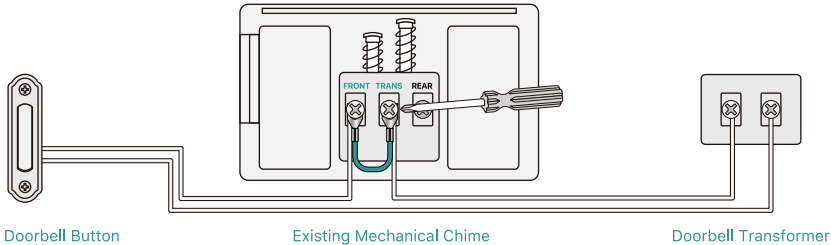

- 3 **Select a location for your video doorbell.**

Determine the mounting position of the doorbell. Check if you can reuse the existing holes on the wall. If not drill new holes to mount your video doorbell.

It is suggested to mount the doorbell at least 4 feet (120 cm) above the ground for optimal angle of view and best motion detection performance.

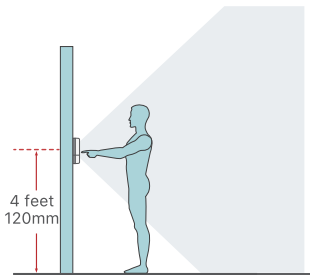

(Optional) Use the 20° angle mount as a supplementary mounting bracket, to adjust the viewing angle towards to fit your viewing preference.

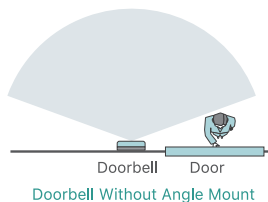

Doorbell Without Angle Mount

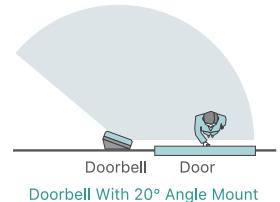

Doorbell With 20° Angle Mount

4 Replace your existing doorbell.

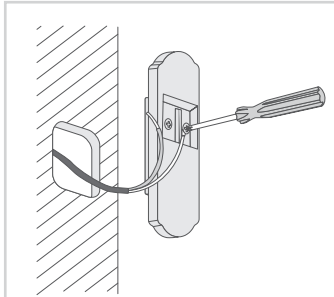

Remove the existing doorbell from the wall and disconnect the wires.

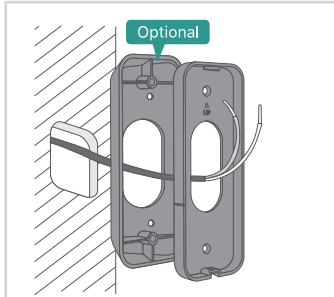

Lead the wire through the holes on the bracket before mounting.

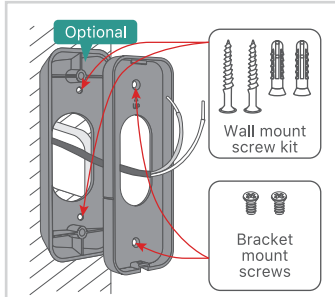

Mark the screw holes location and mount the brackets on your wall with screws.

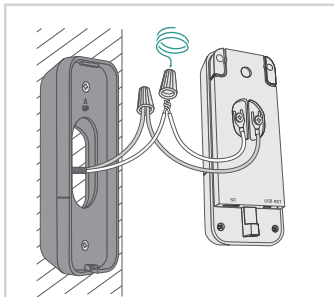

Attach the wires to the doorbell.
Wire extension kits are optional.

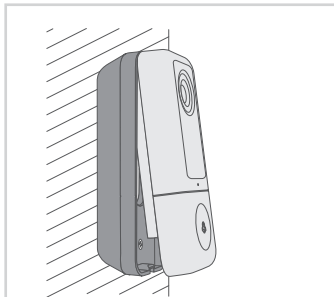

Feed the wires back to the wall and
Mount the doorbell to the brackets.

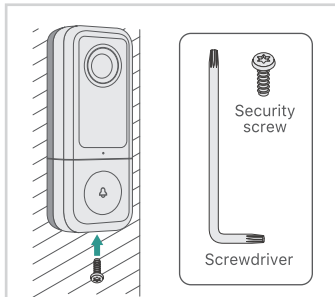

Insert the screw into the bottom
and tighten with included tool.

5 Restore power at the breaker, and your doorbell is ready for use.

10.2 HARDWIRE INSTALLATION

Hardwire your doorbell with the provided DC12V power adapter.

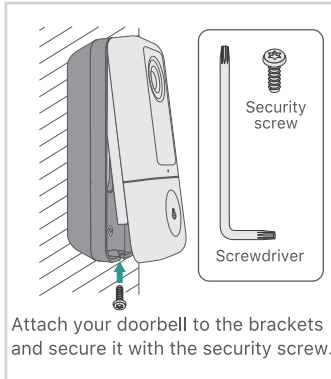
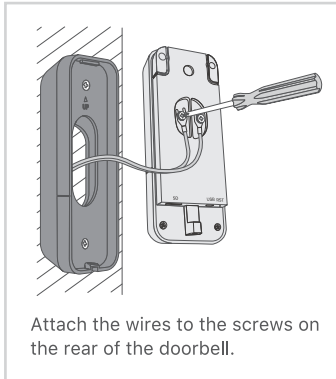
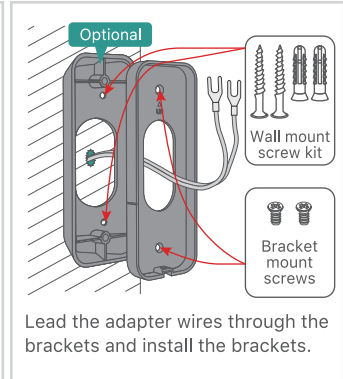
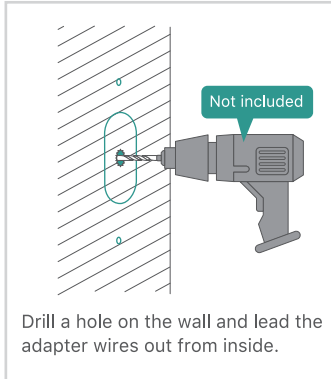
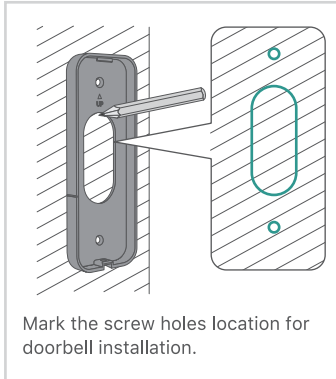

11. TROUBLE SHOOTING

Q1: Is the video doorbell powered by battery?

A1: No, this video doorbell requires constant hardwire power supply. Compared to battery powered doorbells, this wired video doorbell has more advanced features, like supporting full day recording, no delay quick response to visitor calls, and smaller in dimension, fitting into narrow door frames.

Q2: How to connect the hardware to the doorbell? Does the cable order matter?

A2: Your doorbell works with both DC 12V and AC 12V - 24V hardwire power source. There are 2 terminal screws on the rear of your doorbell, and you can connect each wire to each power terminal screw. The cable order doesn't matter.

Q3: I found a Micro USB port near the Micro SD Slot, what's it for?

A3: You can power up the doorbell by the Micro USB port, using an USB compatible charger and cable. It is designed mainly for product testing in the factory.

Q4: What's the Wi-Fi range of the video doorbell?

A4: The video doorbell works with any 2.4GHz wireless Wi-Fi router, mesh system or modems. In outfield test, it works well in most 3000sqft houses. The Wi-Fi range may vary because of different WiFi transmit power, transmission distance and wall blocks in between.

Q5: I installed my video doorbell, but the video or audio quality is poor

A5: In live view interface, WiFi status will be listed. It is suggested to ensure the Wi-Fi status be more than 70%, so as to get your doorbell work as expected. If you think your problem is caused by low Wi-Fi signal strength, try moving your Wi-Fi router closer, or add one Wi-Fi Booster to extend your Wi-Fi range.

Q6: Does the video doorbell work with existing indoor mechanical chime?

A6: No. The doorbell comes with an USB compatible wireless chime to notify people when your visitor presses the doorbell button. If you have an existing indoor chime, please use the provided jumper to bypass the existing chime, so as to provide sufficient power to the new video doorbell.

Q7: How many wireless chimes can be paired with one video doorbell?

A7: You can add as many wireless chimes as your wish on one video doorbell.

Q8: Does it support customized Motion Detection Zones?

A8: Yes it does. Go to **Settings - Alarm Setting - Motion detection - Alarm Area**. Use your finger tips to draw one or more customized motion detection zones and save your settings, and the orange zones are motion detection zones.



Q9: How does the video doorbell detect the motions? Can motion detection be disabled?

A9: The doorbell camera detects motion through the full-image pixel contrast, it will further undergo a human-shape detection to reduce false alarm rate. You can adjust the motion detection sensitivity, customize detection zone, schedule alarm intervals and disable motion detection accordingly due to various user scenarios.

Q10: Does the doorbell support cloud storage?

A10: Your doorbell support MicroSD card storage as well as cloud storage. You can activate the cloud storage service in App. There is a 7-day free cloud recording trial service. Please note that cloud storage only support event recording but not full day recording.

Q11: Does it work with Google Home or Alexa?

A11: Yes, it works with Google voice assistant as well as Amazon Alexa.

