

QUICK START GUIDE

V6.1.1

Model: Bell J4



2K
Smart
Wire-free
Video Doorbell

* Thanks for purchasing and using our product. Please read this quick start guide before using, and keep it for future reference.

* Manual contents are subject to change without notice in accordance with our policy of continuous product improvement.

Warranty Service

Thank you for purchasing products from **KAMEP**. We distinguish ourselves by an unrelenting commitment to excellence in terms of our reliable quality, robust design and whole-hearted service. All items you bought from **KAMEP** enjoy lifetime warranty service. Should you have any questions in using our products, please feel free to contact us by e-mail. A reply emails with solution will reach you within 24 hours.

Your advice or suggestions will be highly appreciated and welcomed.

E-mail: support@kameplife.com

Whatsapp: [\[+86\] 189-2848-4091](https://wa.me/8618928484091)

Website: www.kameplife.com

INDEX

PAGE

1. Meet the Doorbell -----	P1
2. Meet the Chime -----	P2
3. Charge your Doorbell -----	P2
4. APP Download -----	P3
5. Set up Doorbell -----	P3
6. Set up Chime -----	P4
6.1 Supply power to the chime -----	P4
6.2 Click reset button -----	P4
6.3 Press the doorbell button-----	P4
6.4 Chime settings -----	P5
7. Installation -----	P6
7.1 Select location -----	P6
7.2 Instal the doorbell -----	P6
7.3 Wire-free installation(Recommended) -----	P7
7.4 (OPTIONAL)Hardwire your doorbell -----	P8
8. Accessories(Optional) -----	P9
8.1 Angle Mount -----	P9
8.2 Solar Charger -----	P10
9. Trouble shooting-----	P11

1. Meet the doorbell

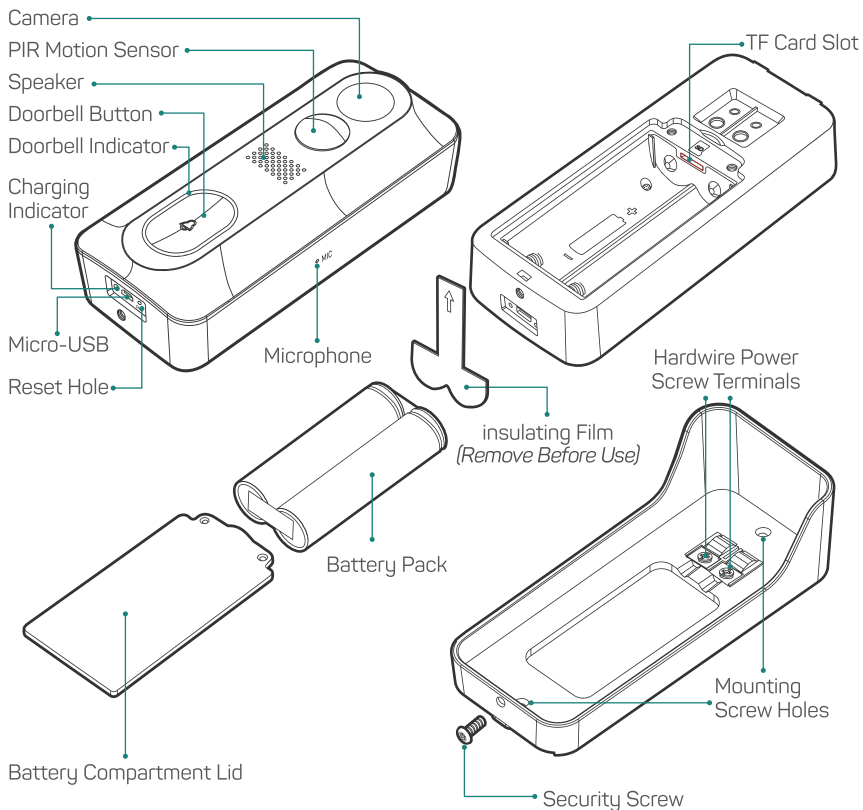

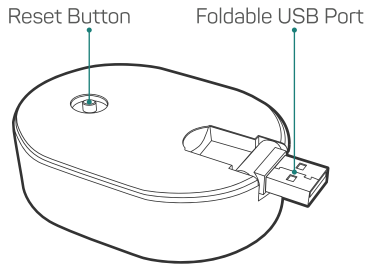
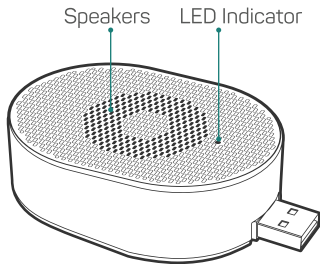

2. Meet the Chime



3. Charge your doorbell

Prior to the doorbell installation, please charge up your doorbell for about 8-10 hours till the charging LED turns BLUE from RED.

LED STATUS	INDICATION
 Solid red	Battery charging
 Solid blue	Fully charged

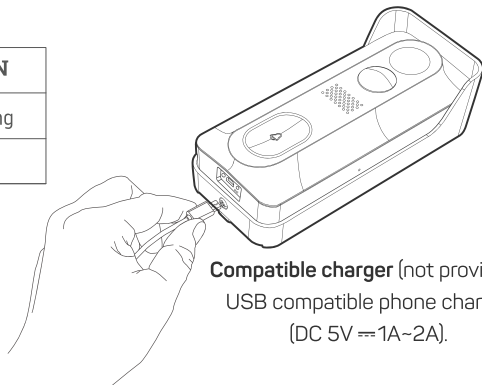

Compatible charger (not provided):
USB compatible phone charger
(DC 5V \approx 1A-2A).

4. App download

Search 'Cloudot' in the App stores or scan below QR codes to download the App.



Cloudot



5. Set up doorbell

1 Press your doorbell, and you will see the LED indicator flashes red (once per second). Start setting up your doorbell following the in-app instructions.

2 Tips

Please operate the setup near your Wi-Fi router.

Make sure your phone is connecting to a 2.4GHz Wi-Fi.

Make sure the doorbell is turned on, and its indicator LED is flashing red. If not, press and hold RESET for 5 seconds.

Ensure the Wi-Fi signal is good, and the Wi-Fi password is correct.

LED STATUS	INDICATION
Solid red	Device is abnormal.
Flash red (once/sec)	Ready for Wi-Fi config.
Flash red (twice/sec)	Connecting to Wi-Fi

LED STATUS	INDICATION
Solid red	Device is online
Flash blue (once/sec)	Live-viewing camera
Flash blue (twice/sec)	Firmware upgrading

6. Setup the chime

1 Supply power to the chime:

Plug your chime to an USB compatible phone charger or the USB port on your PC/notebook.

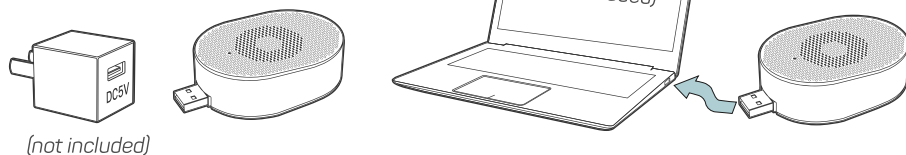

2 Click reset button:

Click the RESET button, and the LED indicator blinks blue for about 20 seconds. It indicates that the Chime is in pairing mode.

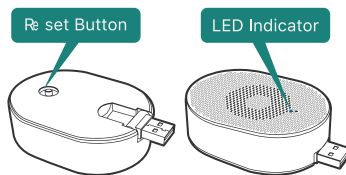

3 Press the doorbell button:

Press the doorbell button, and the Chime will sound to react. Pairing succeeds, and the indicator on the chime will be in solid blue.

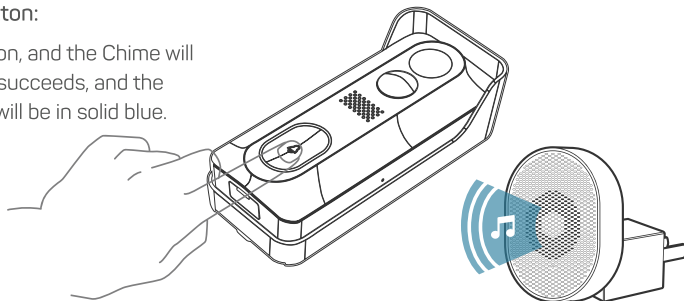

4 Chime settings

You can enter into the chime setting page to mute the Chime Reminder, select ringtones, adjust chime volume or unbind the connection with your doorbell.

STEPS:

Settings → Chime Settings → Wireless Chime

NOTE:

1. Your doorbell communicates with the chime via Radio Frequency, but not WiFi. You can even do the pairing prior to doorbell configuration.
2. You can add many chimes to one doorbell, and vice versa.
3. Press and hold RESET button on the chime for 5 seconds till the indicator flashes blue 3 times, and you can also release the connection between the chime and its connected doorbell.

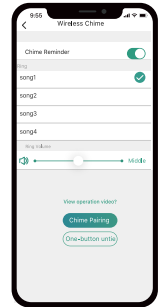

7. Installation

- 1 Select location.

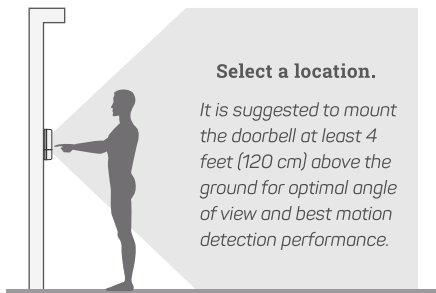

- 2 Install the doorbell.

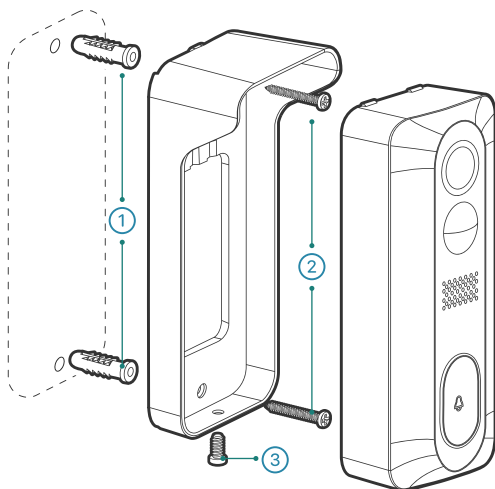

- 1 **Anchors (Optional)**

Needed when mounting to a hard surface, such as brick or stucco.

- 2 **Mounting Screw**

Drive in to fix the doorbell bracket on your wall.

- 3 **Security Screw**

Attach the doorbell to its bracket, and secure it with the provided security screw.

3 Wire-free installation (Recommended)



1. Mark the screw hole position.

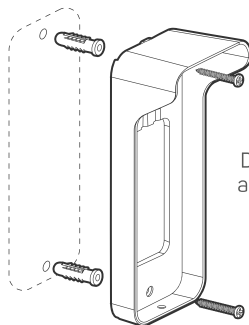

2. Install the mounting bracket.

Double-sided adhesive tape

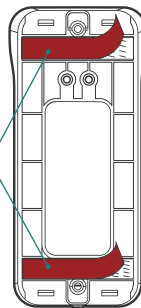

3. **(Optional)** Use tape instead of screws when mounting on flat surfaces.

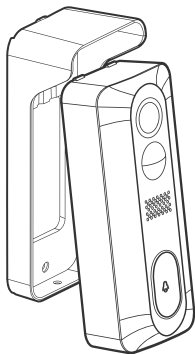

4. Attach the doorbell to its bracket.

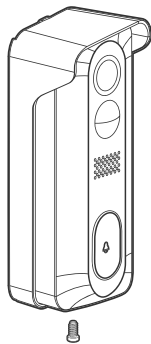

5. Drive in the security screw.

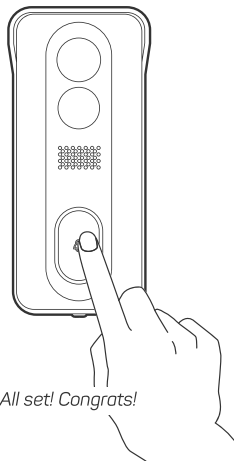

6. All set! Congrats!

4 (OPTIONAL) Hardwire your doorbell.

The doorbell works with both 12V ~ 24V AC and DC hardwire power source. Either wire can be connected to either terminal. The cable order doesn't matter.

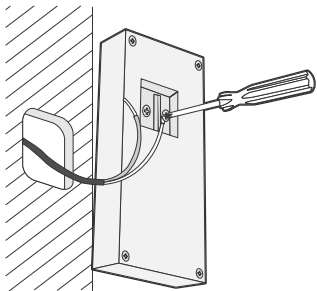

1. Shut off power, and disconnect he hardwire from your old doorbell.

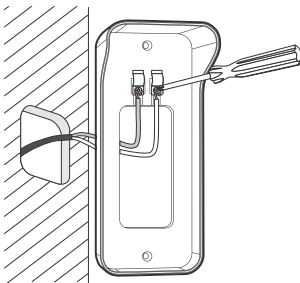

2. Connect the wires to the screw terminals on the mounting bracket.

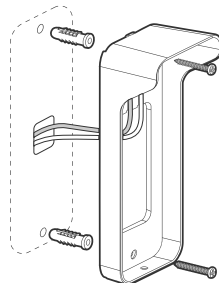

3. Install the mounting bracket.

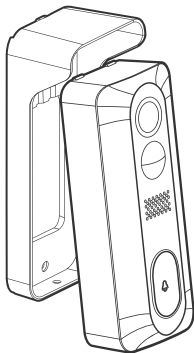

4. Attach the doorbell to its bracket.

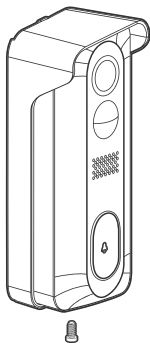

5. Drive in the security screw.

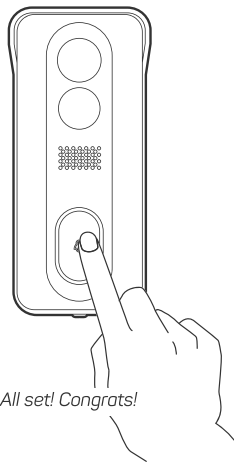

6. All set! Congrats!

8. Accessories (Optional)

1 Angle Mount

The symmetric designed angle mount can adjust your doorbell view angle by 20° ~ 40° to the left or right.

It helps to point your doorbell to a specific angle of view so as to improve your motion detection and get a better view of visitors coming to your door.

Note:

The angle mount is sold separately, and is not included in the package.

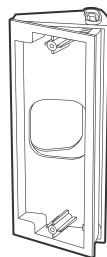

Angle Mount (AGM01)



2 Solar Charger

If your doorbell is under direct sunlight, it is great to add one solar charger, which can power your doorbell and extend its battery life with the help of solar power source.

With just a few hours of direct sunlight everyday, your doorbell will stay charged around the clock.

Note:

The solar charger is sold separately, and is not included in the package.

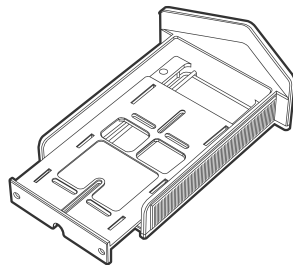

Solar Charger (SC01)



P10

9. Trouble shooting

Q1: Why I failed to set up Wi-Fi for the doorbell?

A1: ①.Device works with 2.4GHz Wi-Fi only, but not support 5GHz Wi-Fi. ②.Wi-Fi network is not good, try to keep the camera near the Wi-Fi router when setting up. ③.The Wi-Fi password is wrong. Please check if there are special characters in the password, or the network is specially encrypted.

Q2: How do I know if I have 2.4G or 5G wifi?

A2: Please check the user manual of your Router or call the network operator for help.

Q3: It has to be on same WiFi to see the camera, or is it over internet from anywhere?

A3: You can view the camera from anywhere, if your camera is well connected to the internet.

Q4: Do any of the recordings get saved to the cloud? Or is it mainly saved in the built-in SD card?

A4: It supports SD card recording as well as cloud storage. You can activate the cloud storage service in App.

Q5: What happens when the SD is full?

A5: When the memory card is full, the camera automatically erase the oldest footage.

Q6: Does it work with Google Home or Alexa?

A6: Sorry, this model does not support Google Home or Alexa.

Q7: Why does it lose connection to wifi?

A7: Please check the network connection of your phone and the Wi-Fi router. If the network signal is not strong, you may need to move your router closer to the device, or invest in an extender.

Q8: Can the motion detection be disabled?

A8: Yes, sure. Recording is triggered by detected motions. You can set up the sensitivity or disable motion detection in the setting menu.

Q9: Do we get charger for the batteries?

A9: Battery charger is not included. Please charge the batteries with a USB compatible charger (DC5V 1A-2A) for about 8-10 hours.

Q10: Can we have 2 or more doorbells at the same residence?

A10: Yes, you can add more than one device at the same residence.

