



Aqua Creek Products

THE LEADERS IN RECREATION, FITNESS, AND ABILITY!

9889 Garrymore Ln

Missoula, MT 59808

888-687-3552 | +1-406-549-0769

www.aquacreek.com

PRO WAVE
POOL BIKE

PART #: F-PWRWV-02

AVAILABLE IN PINK, GREEN OR YELLOW
300 LB. [136 kg] MAXIMUM WEIGHT CAPACITY

MANDATORY

LEAVE THIS MANUAL WITH BIKE OWNER

Read and follow all instructions.

Bike safety can only be ensured if the bike is assembled and operated according to these instructions.

- NEVER permit children to play on or around the bike.
- Optimal use in water depth of 3.5 to 5 feet (1 to 1.5 meters).
- For safety reasons, NEVER exercise alone in the water.



ProWave Pool Bike

Table of Contents

PAGE	DESCRIPTION	PAGE	DESCRIPTION
2	ProWave Components	8-9	Trainer Reference Guide
3-4	Assembly Instructions	10	Proper Care of ProWave
5	Operating Instructions	11	Exploded View & Parts List
6-7	Common ProWave Exercises	12	Warranty

ProWave Components

1. MAIN FRAME
2. FRONT BASE
3. BACK BASE
4. ADJUSTABLE HANDLEBARS
5. SEAT HEIGHT ADJUSTMENT
6. SPORT SEAT
7. TENSION ADJUSTMENT
8. RIGHT PEDAL
9. LEFT PEDAL
10. 1/4 X 3/8 SHOULDER BOLT (6)
11. #10 FLAT WASHER (6)
12. #10 NYLOCK NUT (6)
13. 5/16 X 3/4 HEX BOLT (2)
14. 5/16 LOCK WASHER (2)
15. 5/16 FLAT WASHER (2)
16. DIELECTRIC GREASE PACKET

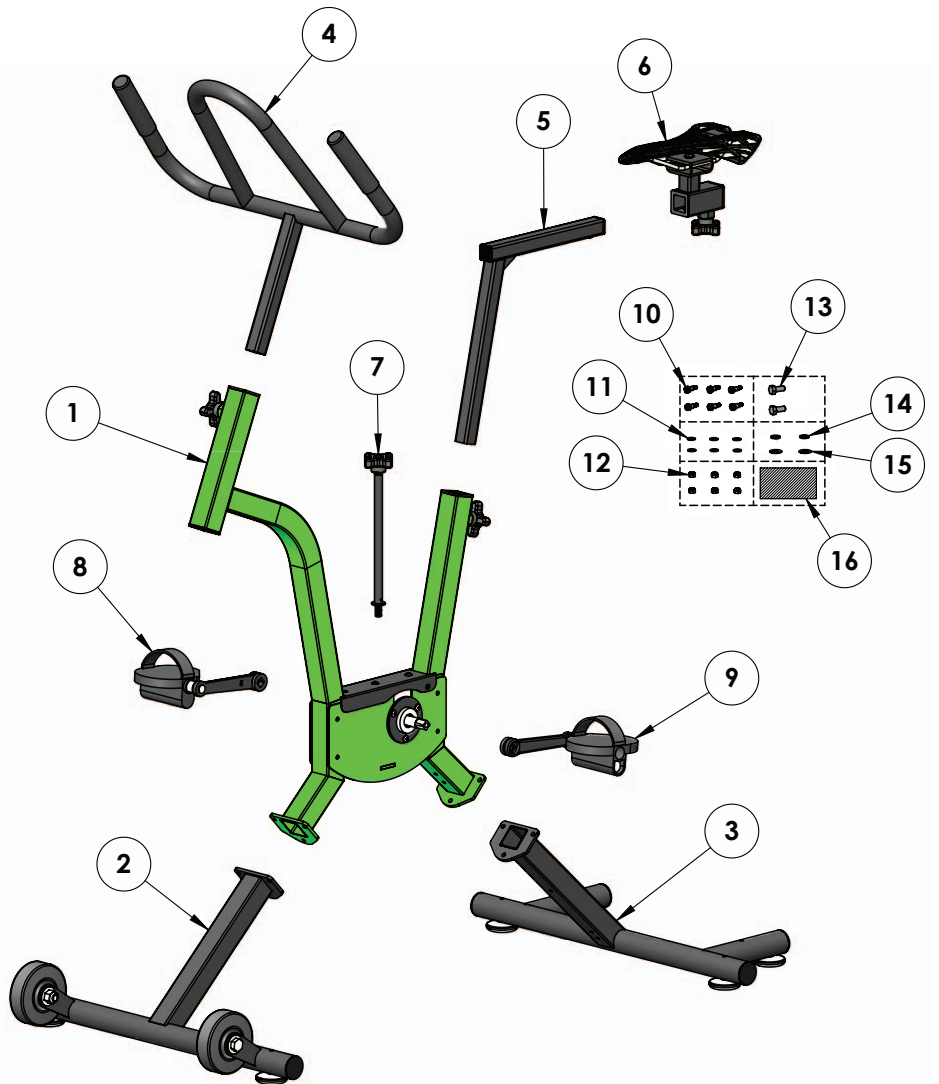

ProWave Assembly Instructions

TOOLS REQUIRED:
1/8" ALLEN WRENCH & 3/8" WRENCH OR SOCKET
DIELECTRIC GREASE

1. Attach the front and back base assemblies to the main frame using the supplied 1/4 x 3/8 shoulder bolts, #10 flat washers and #10 nylock nuts.. See FIG. 1 below.

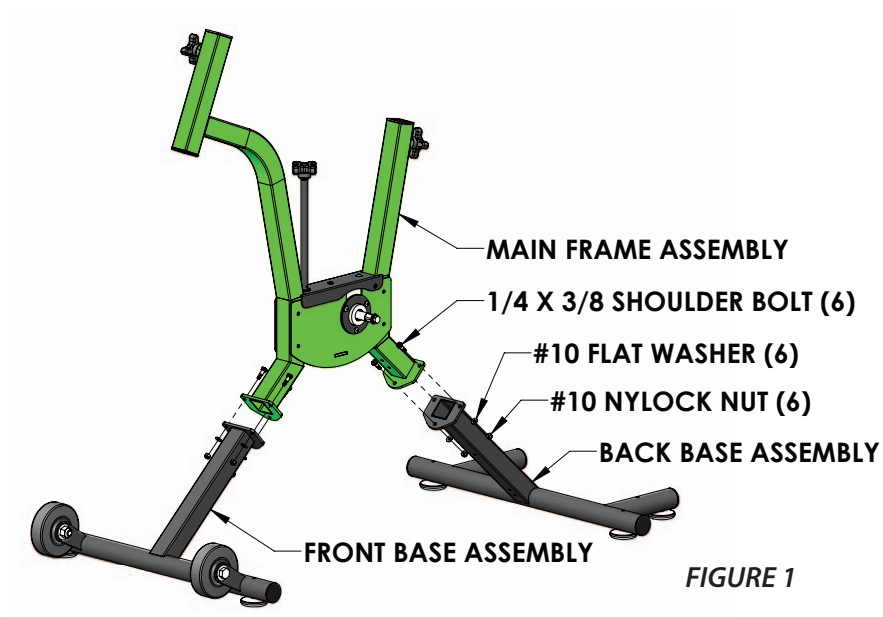

2. Attach the handlebar assembly, seat adjustment assembly and seat assembly using the adjustment knobs. See FIG. 2 below.

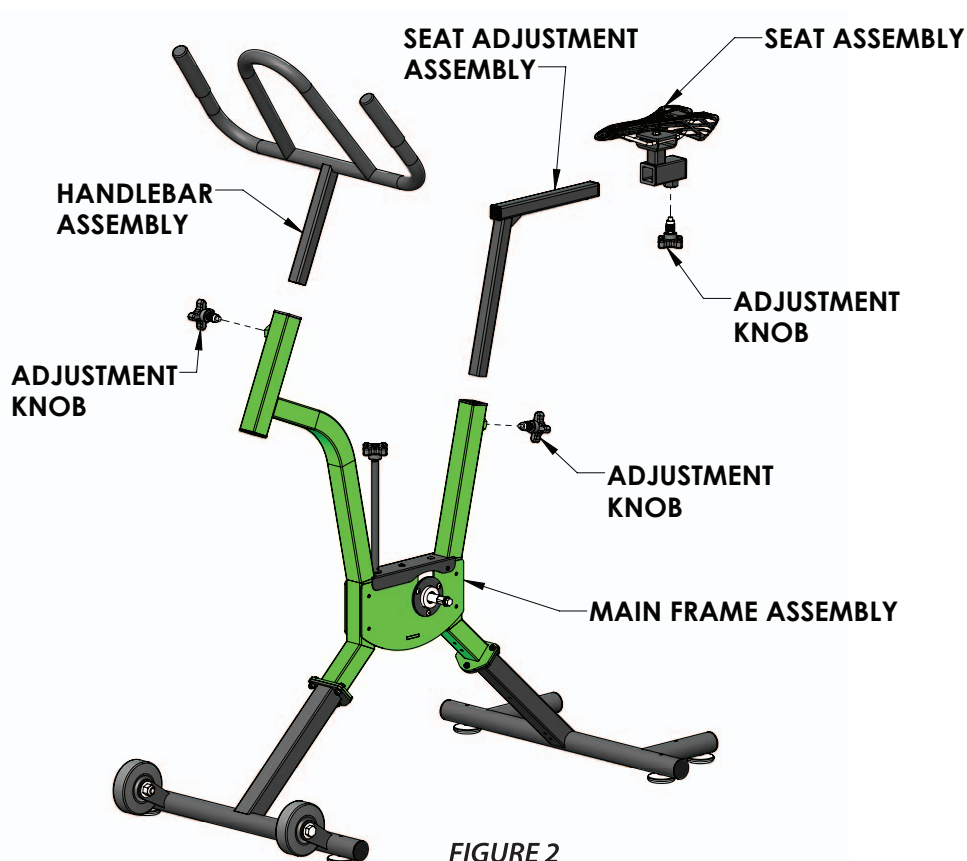

ProWave Assembly Instructions

TOOLS REQUIRED:
1/2" SOCKET

3. Attach the pedals to the bike using the supplied 5/16" hex bolts, lock washers and flat washers. See FIG. 3 below.

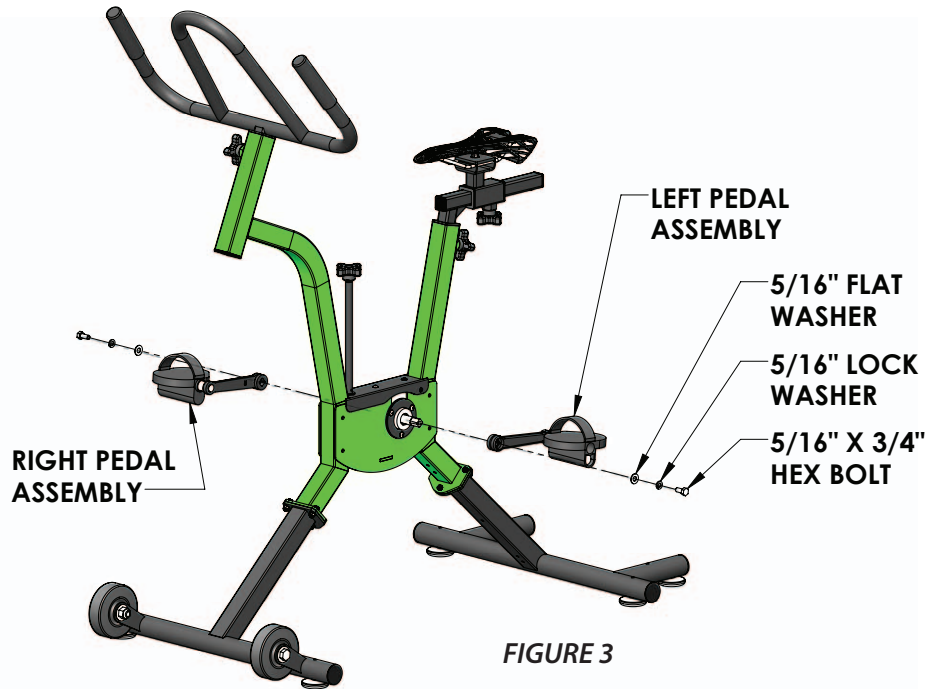

NOTES: Viewing from as if sitting on the bike, be sure the right pedal is being installed on the right side of the bike and left pedal on the left side of the bike! Installing them backwards could lead to the pedals unthreading and breaking off!

Be sure the pedals are opposite each other! If the left pedal is all the way up, the right pedal should be all the way down!

The ProWave Bike is now fully assembled! Please note that it is easiest to set seat height, handlebar location and foot strap tightness BEFORE placing the bike in the water. See chart below to properly adjust the seat height to best suit the user. Before riding, always check that the seat post is securely clamped. Riding with an improperly tightened seat post can allow the seat to slip and/or fall.

Height	Inseam Length	Frame Size
5'0" - 5'3"	26.5" - 28"	19" - 19.63"
5'2" - 5'5"	27.5" - 29"	19.68" - 20.5"
5'4" - 5'7"	28.5" - 30"	20.5" - 21.25"
5'6" - 5'9"	29.5" - 31"	21.25" - 22"
5'8" - 5'11"	30.5" - 32"	22" - 22.83"
5'10" - 6'1"	31.5" - 33"	22.83" - 23.63"
6'0" - 6'3"	32.5" - 34"	23.63" - 24.5"

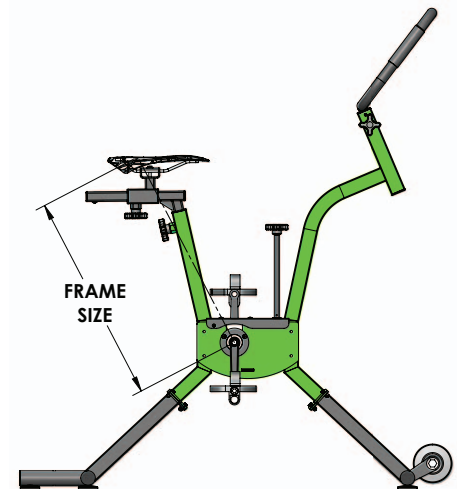

ProWave Operating Instructions

The ProWave Pool Bike was designed for use in and out of the water. To use in water, use the wheels at the front of the bike to roll the bike down the pool wall into the water. Optimal water depth is 3.5-5 feet (1 to 1.5 meters). See FIG. 4 & FIG. 5 below.

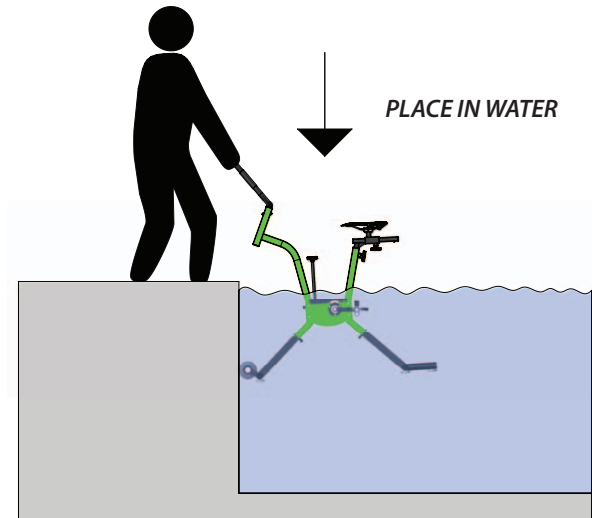

FIGURE 4

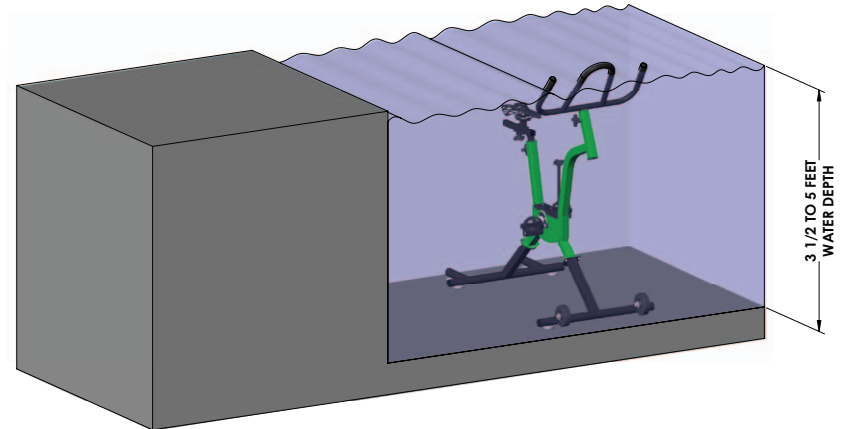

FIGURE 5

The ProWave pool bike can be set to multiple levels of resistance. The resistance adjustment knob is located on the main frame. To increase resistance for a harder workout, turn the knob clockwise. To decrease resistance, turn the knob counter-clockwise. See FIG. 6 and FIG. 7 below.

NOTE: Always begin pedaling on the easiest level and increase resistance to more difficult settings while pedaling. Never start pedaling at high resistance as you may experience a transmission bind up. However, if this does occur, release the resistance back to easy and begin again.



FIGURE 6

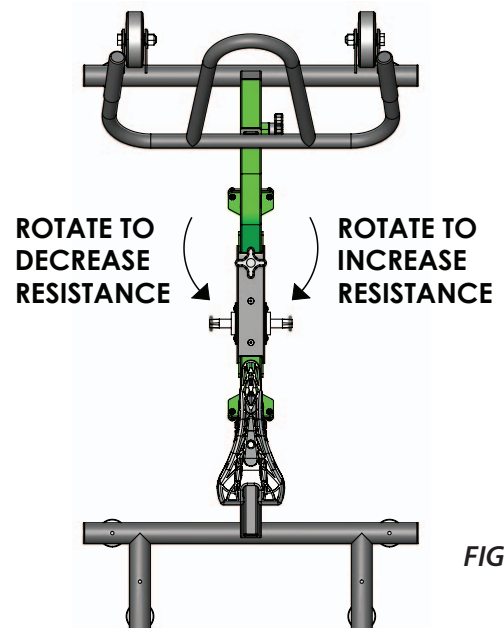
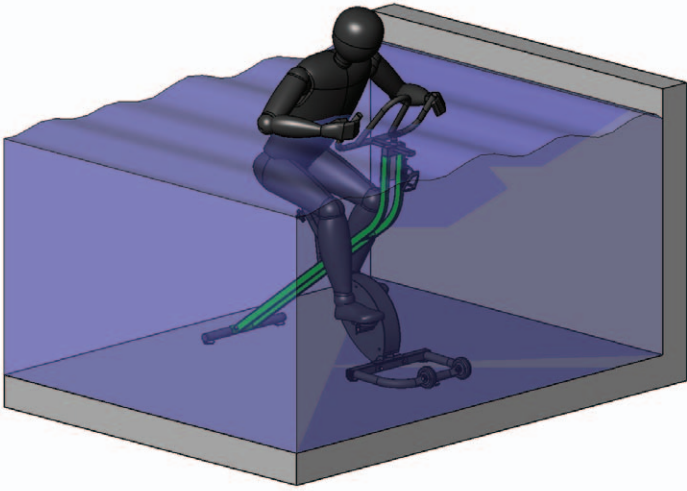

FIGURE 7

*Pedals not shown for clarity

Common ProWave Exercises

NOTE: Bike may not resemble your exact model. The same exercises can be done on all Aqua Creek bikes.



STANDARD RIDE

Rider is sitting on seat with hands gripping the handlebars.

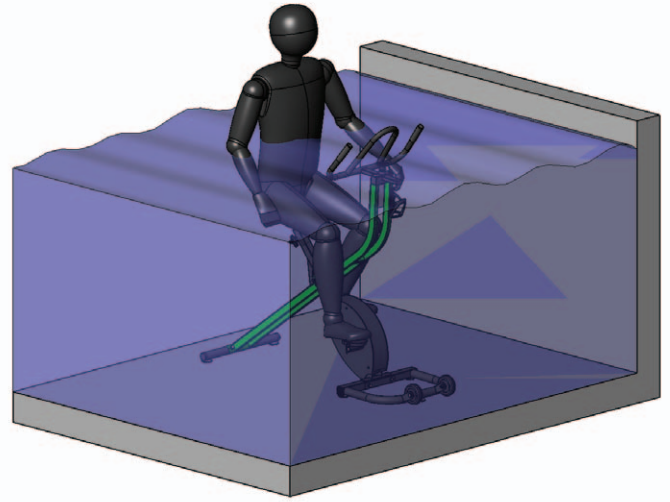

RELAXED RIDE

Rider is sitting on seat with hands dangling in the water.

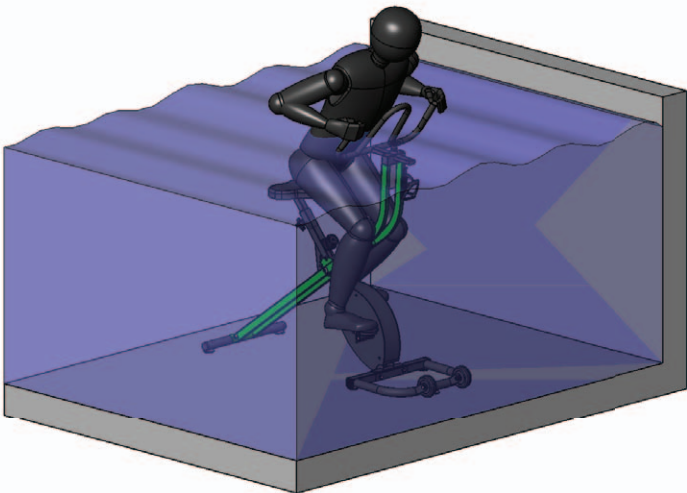

STANDING RIDE

Rider is off the seat, standing and pedaling, with hands gripping the handlebars.

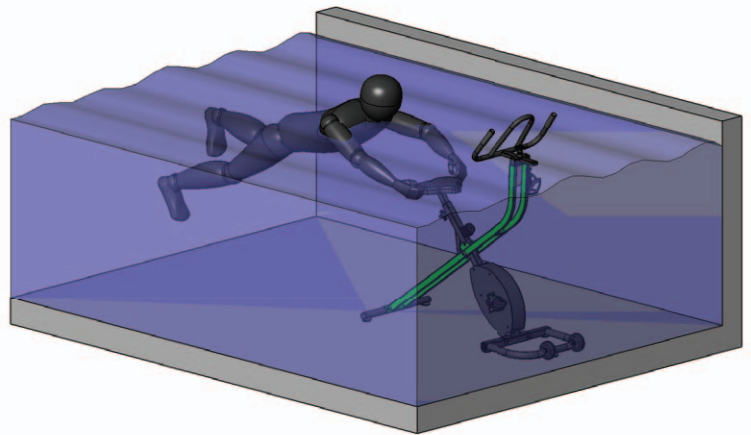

FLUTTER KICK

Rider is behind the bike holding the seat and kicks legs in a swimming motion.

Common ProWave Exercises

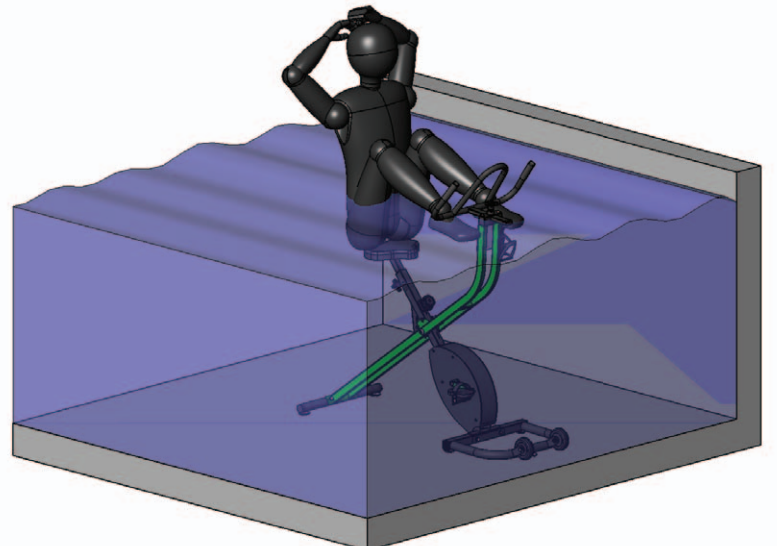
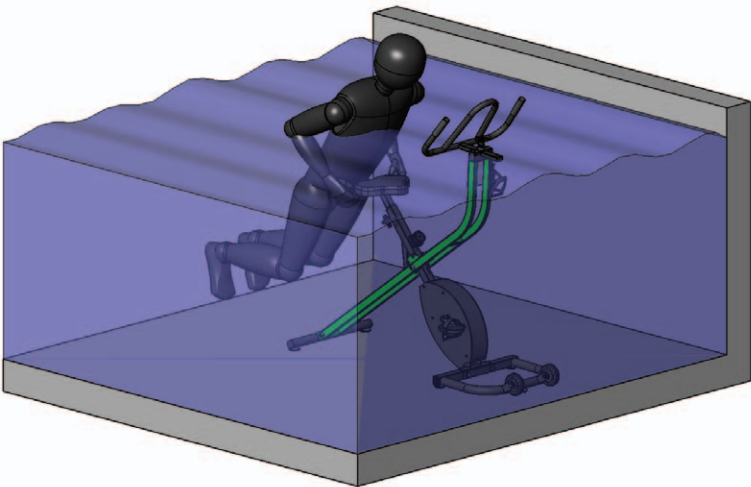
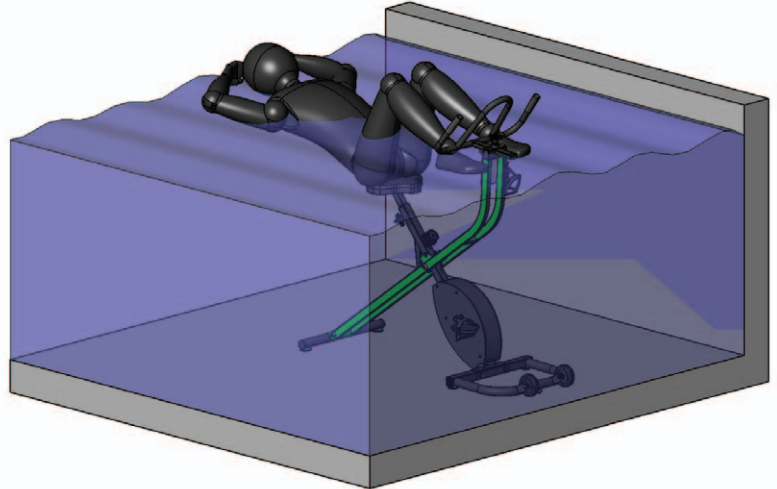
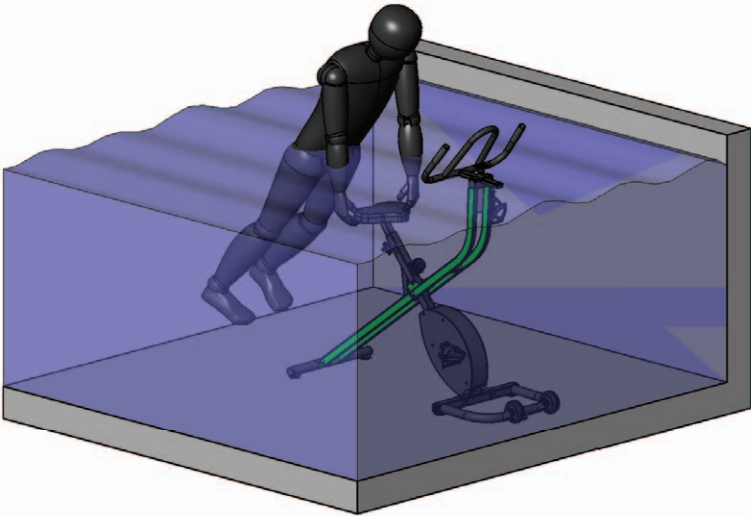

CHEST DIP

Rider is behind the bike holding the seat, lifts legs up and slowly lowers themselves until their chest hits the seat and then pushes themselves back up.

ABDOMINAL CRUNCH

Rider is on seat with feet hooked under the handlebars. Lean back until back of head hits the water and then return to an upright position, using only your core.

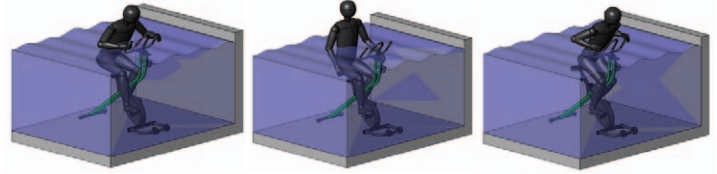

Saddle

Saddle-Upright

Standing

Trainer Reference Guide

Terminology

"Saddle": means to be seated on the bike saddle, with hands on the handlebars.

"Saddle-Upright": means to be seated with hands OFF the handlebars.

"Standing": off the saddle, hands on the handle bars; body is more vertical than seated alignment. Pedaling action is happening directly below the hips. It is recommended that riders use the handlebars in this position, rather than pedaling hands off.

Riding Position	Hands/arms position	Class Component Length of time & Resistance level	Helpful Cues
Standing	<ul style="list-style-type: none"> • Hands remain on the handle bars while standing. • The body is tall and straight, not hunched over the handlebars. • Grip should be firm but relaxed. • Avoid tensing the shoulders and neck. 	<p>Cardiovascular Exercise Intervals:</p> <ul style="list-style-type: none"> • 1-2 minutes at a time, increase when possible. • Start with shorter intervals of 10 – 20 seconds if the rider is inexperienced or unfit. • Gradually increase the time spent standing, and / or increase the resistance setting on the bike. • Riders can adjust cadence to increase the challenge of the interval. Faster is more difficult. However, smooth pedal stroke should always be maintained. • Perceived exertion levels of 7 – 9 are appropriate unless health concerns dictate otherwise. Medical clearance for cardiovascular exercise should be mentioned. <p>(Resistance – moderate to high)</p>	<ul style="list-style-type: none"> • Maintain long, strong alignment throughout these intervals. • Inability to maintain alignment and / or the smooth efficiency of the pedal stroke means the work interval is too challenging – sit and resume seated pedaling until you are recovered sufficiently to try another standing interval. • Monitor the comfort of the low back and knees during this activity. • Adding arm movement to this position is not advised for most. Very experience riders may achieve this, but alignment and smooth pedal stroke are always the priority. • Vigorous arm movements combined with inadequate core stability can cause the bike to tip while riding – not recommended.

Riding Position	Hands/arms position	Class Component Length of time & Resistance level	Helpful Cues
<p>Saddle In this position, water level should be at approximately mid-sternum.</p>	<p>Hands grip the horizontal portion of the handle bars or wider grip.</p> <p>Tip: Use a light grip, elbows slightly bent – rest the hands where they are most comfortable for your body. Experiment with a variety of hand placements & change placement during the workout as desired.</p> <p>NOTE: When more resistance is added, riders tend to grip too firmly on the handlebars. Maintain a relaxed grip to avoid unnecessary tension in the arms, shoulders and neck. Tight grips restrict blood flow and elevate blood pressure, so are not advised.</p>	<p>Warm up:</p> <ul style="list-style-type: none"> • 3-5 minutes of spinning with little or low resistance. • Warm-up needs to be more vigorous and longer in water that feels cool. It can be shorter in warm (therapy) pools (≥90 F). • This part of the workout is useful for achieving comfortable alignment, hand position, and pedal stroke. • Exertion level: Low; feels great, you can easily talk; not breaking a sweat. • (Resistance – low) 	<ul style="list-style-type: none"> • Hold correct body alignment: long spine, neutral neck, shoulders down. • Focus on the efficiency and smoothness of the pedal stroke. • Pedal should feel <i>even</i> ‘around the clock’; equal push and pull, not just pushing down.
<p>Saddle-Upright</p> <ul style="list-style-type: none"> • In this position, water should be no lower than the bottom of the sternum. • Strong individuals can use gloves to increase resistance. • Buoyant dumbbells or resistive hand wands can be added, but instruction should be given to protect the shoulders, neck, elbows & wrists. 	<p>Seated on the Saddle with hands off the handle bars. The torso is more upright than the Saddle position. All arm actions can be done with both arms moving in unison, or arms moving alternately (usually more challenging for the core).</p> <p>Arm/hand movements for interest and intensity: Keep the arms in the water to use the resistance of the water. Do not move the arms in and out of the water.</p> <ul style="list-style-type: none"> • Breast stroke – large sweeping movements forward, to the sides & in. • Modified breast stroke: use the back of the arms & hands to do the breaststroke motion, keeping the thumbs up. Bring the arms as far out and behind the body as possible (externally rotated). • Cross-country ski arms: palms facing forward swing the arms forward and backward beside the body, surface to surface of the water – alternate or in unison. • Jumping jack arms: palms facing down; don’t let the arms come out of the water. 	<p>Work out: Arm Intervals</p> <ul style="list-style-type: none"> • Use this option for 5 – 10 minute intervals between episodes of cardio intervals. • Maintain steady cadence. • The rider should feel somewhat challenged and slightly breathless. • (Resistance – moderate) 	<ul style="list-style-type: none"> • Maintain correct body alignment and the smoothness and efficiency of the pedal stroke. • If alignment is lost, slow down the pedal stroke while executing arm movements. • Avoid having the body sway side to side. • Keep the core fixed, vertical, and strong. • Stay well connected to the saddle. • Keep the hands in the water throughout. • Power posture: core vertical, shoulders down, neck relaxed.



Connie Jasinkas, M.Sc., CEP



www.FortheLoveofFit.com



www.AquaStretchCanada.com

Proper Care of ProWave Pool Bike

PROCEDURE	DAILY	WEEKLY	MONTHLY
Wash down bike with fresh water and dry with clean, soft, non-abrasive cloth.	✓		
Visually inspect bike for damage, corrosion, and loose or missing hardware.	✓		
Check and make sure pedals and pedal hardware are tight before use. Failure to do so will cause the hardware in the pedal to break.	✓		
Thoroughly clean bike frame and apply a liberal coat of car wax to maintain the bike's finish.		✓	
Check all Warning and Cautionary labels to make sure they are not faded or worn. Replace as needed.			✓

PROPER CARE NOTES

- **Use only fresh water to wash your bike. Do not wash with pool water.**
- Use only clean, soft, non-abrasive cloths to wipe down your bike.
- Remove bike from pool after each use and wash down.
- Do not store bike in pump room or near chemicals.
- Do not allow children to play on or around this bike.

STAIN REMOVAL TIPS:

To remove stains, wash affected area with mild dish soap. For stubborn spots and stains, try using Soft Scrub™ with some brisk rubbing. Apply wax to finish.

NOTHING LASTS FOREVER, INCLUDING YOUR BIKE:

When the useful life of your bike or its components is over, continued use is hazardous. Every bike and its component parts have a finite, limited useful life. The length of that life will vary with the maintenance and care the frame and components receive over their life; and the type and amount of use to which the frame and components are subjected. Aggressive riding, riding in a severe environment (such as a lake or other non pool environment), riding with heavy loads, commercial activities and other types of non-standard use can dramatically shorten the life of the frame and components. Any one or a combination of these conditions may result in an unpredictable failure. You should have your bike and its components checked periodically for indicators of stress and/or potential failure, including cracks, deformation, corrosion, powder-coat peeling, dents, and any other indicators of potential problems, inappropriate use or abuse. These are important safety checks which may help prevent accidents, bodily injury to the rider and shortened product life.

For service and/or replacement parts; contact Aqua Creek direct at
Toll free: (888) 687-3552 or (406) 549-0769

ProWave Exploded View & Parts List

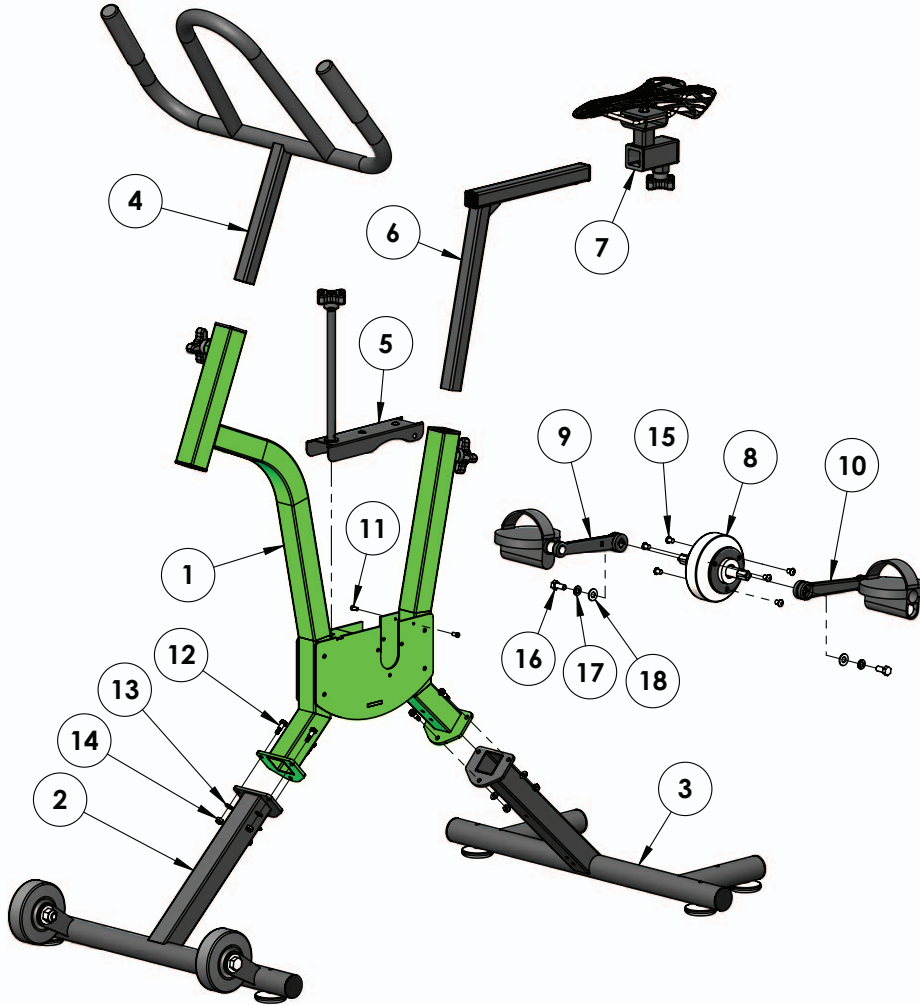

ITEM #	QTY	PART #	DESCRIPTION
1	1	PWV-100-00	MAIN FRAME ASSEMBLY
2	1	PWV-200-00	FRONT BASE ASSEMBLY
3	1	PWV-300-00	BACK BASE ASSEMBLY
4	1	PWV-400-00	HANDLEBAR ASSEMBLY
5	1	PWV-500-00	TRANSMISSION CAP ASSEMBLY
6	1	PWV-700-00	SEAT CONNECTION ASSEMBLY
7	1	PWV-800-00	SEAT ASSEMBLY
8	1	PWV-900-00	CRANK SHAFT ASSEMBLY
9	1	AQF-PDR-03	RIGHT PEDAL ASSEMBLY
10	1	AQF-PDL-03	LEFT PEDAL ASSEMBLY
11	2	BSH 10 X 3/8	BOLT, 316 SS, 10-24 X 3/8 SHCS
12	6	BS 1/4 X 3/8	BOLT, 316 SS, 1/4 X 3/8 SHOULDER, 10-24 THREAD
13	6	WF 10	WASHER, FLAT, #10 SAE, 316 SS
14	6	NN 10	NUT, 316 SS, NYLOCK, #10-24
15	6	BBF 1/4 X 3/8	BOLT, 316 SS, 1/4-28 X 3/8 BHSCS
16	2	BHF 5/16 X 3/4	BOLT, 316 SS, 5/16-24 X 3/4 HCS
17	2	WL 5/16	LOCK WASHER, 5/16, 316 SS
18	2	WF 5/16	WASHER, FLAT, 5/16, 316 SS

AQUA CREEK PRODUCTS, LLC LIMITED THREE (3) YEAR WARRANTY:
TIDALWAVE & PROWAVE POOL BIKES
(ITEM #'s F-TWPB & F-PWRWV)

Aqua Creek Products, LLC (a.k.a. Aqua Creek) warrants to the original end user purchaser that products manufactured by Aqua Creek when properly installed in accordance with assembly and installation instructions, and properly used and maintained, shall be free from defects in material and workmanship for a period of **three (3) years from the date of original purchase**, provided that Aqua Creek receives prompt notice in writing of any defect or failure and satisfactory proof thereof, with the following exception(s):

Exception(s)

- All wear parts, i.e. gear mechanism, belts, etc... shall be warranted for **one (1) year from the date of original purchase**.

IMPORTANT: User is not to exceed the rated weight capacity of this product. It is the responsibility of the product owner to verify the weight of the patron for warranty claim purposes and to ensure that the product is not overloaded.

This warranty specifically excludes reimbursement for labor to remove, repair, or install the product and any freight charges. These warranties do not cover any damages due to accident, force majeure, act of nature, misuse, abuse, negligence or failure to properly maintain any products, or normal wear and tear from day to day operations. In the event that any products are altered, repaired, or improperly installed or improperly used by anyone without the prior written approval by Aqua Creek, all warranties are void. Non-payment for product to Aqua Creek may void warranty.

To initiate a warranty claim, the owner of an Aqua Creek product must provide the place of purchase, in writing, with a full description of the product, its serial number, the dates of purchase and installation, and the exact nature of the defect. Within thirty (30) days after receipt of a written warranty claim by Aqua Creek, and barring any unforeseen delays, the place of purchase will be notified of Aqua Creek's decision regarding the claim.

If requested by Aqua Creek, any defective product must be returned, freight prepaid by customer, to Aqua Creek's designated factory location or duly appointed distributor for inspection and/or repair. Aqua Creek will, at its option, repair or replace the failed or defective item, and deliver the repaired product or replacement to the customer. All freight charges are the responsibility of the customer. Products returned to Aqua Creek for which Aqua Creek provides replacement under this limited warranty shall become the property of Aqua Creek. A new warranty period shall **NOT** be established for the repaired or replaced products. Such products shall remain under warranty only for the remainder of the original warranty period on the original products purchased.

This written limited warranty constitutes the final, complete and exclusive statement of warranty terms. No person or organization is authorized to make any other specific or implied warranties or representations on behalf of Aqua Creek.

THE WARRANTIES SET FORTH HEREIN ARE IN LIEU OF ALL OTHER WARRANTIES, EXPRESSED OR IMPLIED, WHICH ARE HEREBY DISCLAIMED AND EXCLUDED, INCLUDING WITHOUT LIMITATION ANY WARRANTY OF MERCHANTABILITY OR FITNESS FOR A PARTICULAR PURPOSE OR USE.

THE SOLE AND EXCLUSIVE REMEDIES FOR BREACH OF ANY AND ALL WARRANTIES WITH RESPECT TO THE PRODUCTS SHALL BE LIMITED TO REPAIR OR REPLACEMENT AT AQUA CREEK'S DESIGNATED FACTORY LOCATION, OR DULY APPOINTED DISTRIBUTOR, OR IN PLACE AT AQUA CREEK'S OPTION. IN NO EVENT SHALL AQUA CREEK'S LIABILITY EXCEED THE ENTIRE AMOUNT PAID TO AQUA CREEK BY THE ORIGINAL PURCHASER FOR THE FAILED OR DEFECTIVE PRODUCT.

IN NO EVENT SHALL AQUA CREEK PRODUCTS, LLC BE LIABLE FOR ANY INCIDENTAL, CONSEQUENTIAL, SPECIAL, INDIRECT, PUNITIVE OR EXEMPLARY DAMAGES OR LOST PROFITS FROM ANY BREACH OF THIS LIMITED WARRANTY OR OTHERWISE.

THIS WARRANTY GIVES YOU SPECIFIC LEGAL RIGHTS AND YOU MAY ALSO HAVE OTHER RIGHTS, WHICH MAY VARY FROM STATE TO STATE. SOME STATES DO NOT ALLOW THE EXCLUSION OR LIMITATION OF INCIDENTAL, SPECIAL OR CONSEQUENTIAL DAMAGES, SO SOME OF THE ABOVE LIMITATIONS OR EXCLUSIONS MAY NOT APPLY TO YOU.

Aqua Creek Products, LLC
9889 Garrymore Lane
Missoula, MT 59808
Toll Free: (888) 687-3552
Local/Intnl: (406) 549-0769
www.aquacreek.com