

Wildcat Gas Portable Filtration System

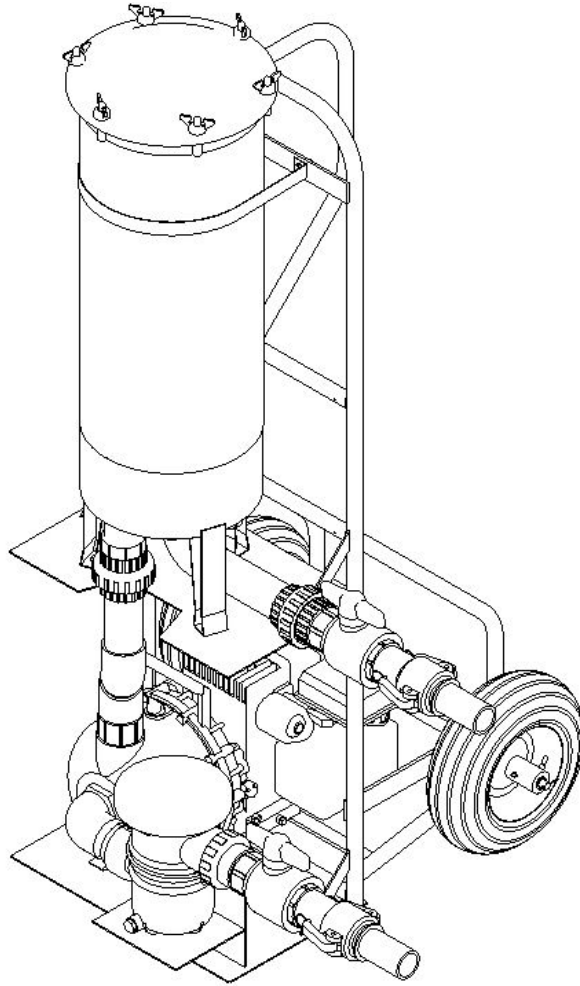

Part Number 10640, 10660

SPECTRUM[®]
Aquatics

A **PLAYCORE** Company

7100 Spectrum Lane ~ Missoula MT 59808
800.791.8056 ~ www.spectrumproducts.com

10640 Man Rev B

You have purchased a Spectrum Products Wildcat Gas Portable Filtration System. Providing the unit is installed correctly and properly maintained, it will furnish you with many years of trouble free use. It is important to read this entire manual prior to beginning assembly or operation.

Shipping Information:

Each Wildcat Pump will arrive fully assembled on one pallet. Before accepting the lift from the carrier, inspect for visible damage and match the contents with those listed below. Spectrum is not responsible for lost or damaged freight.

The pallet will contain all structural components and hardware.

NOTE: Vacuum does not include intake hoses or cleaning attachments.

Operation Guide

Please follow the attached instructions for setup and use of your new Portable Filtration System. If you require assistance or have technical questions please contact your local distributor or Spectrum Customer Service at (406) 532-6321.



1½", 2" & 3" Self-Priming Centrifugal Pump Instruction Manual

Read these instructions and the instructions covering operation of the pump drive unit. Do not operate the gas engine (if so equipped) until you have put oil in the engine. Do not run the pump dry. Always fill the pump with water or the fluid being pumped before starting the drive unit to avoid premature pump seal failure.

The gas engine (if so equipped) is shipped with no oil in it. Consult your engine owners manual for specific oil recommendations and maintenance procedures. For engine warranty service contact your local engine dealer.

Make certain that all hose and pipe connections are air tight. An air leak in the suction line may prevent priming and will reduce the capacity of the pump.

Always place the pump as close to the liquid to be pumped as possible. Keep the suction line short and with few bends. Keep the pump and engine on a level foundation. A poor foundation and a heavy suction hose (made heavier when "primed" full of liquid) could result in a pump "down the hole". It is not necessary to drain the pump body after use, unless there is a danger of freezing.

There are important instructions regarding the preparation of the engine for long periods without use. (Reference the engine instruction manual.) Under these conditions, drain the pump. Leave all plugs (fill and drain) out of the pump. Always store the pump unit in a heated, dry building.

When pumping dirty water or liquids containing solids, always use a pump strainer on the end of the suction line.

There are no points on the pump that need lubrication. The pump seal is cooled and lubricated by the fluid being pumped.

WARNING! Do Not use with Flammable Liquids.

Do not pump flammable liquids or other hazardous liquids with this pump. Failure to follow this warning can result in explosion, serious bodily injury or death. For safe operation read and follow the safety precautions in the following owners manual. Note: Engine warranty service available at authorized Briggs & Stratton and Honda dealers.



DISASSEMBLY INSTRUCTIONS:

1. Remove the 10 body screws (12720), lock washers (V07018) and nuts (V07019) from the pump assembly. Remove the body from the pump assembly.

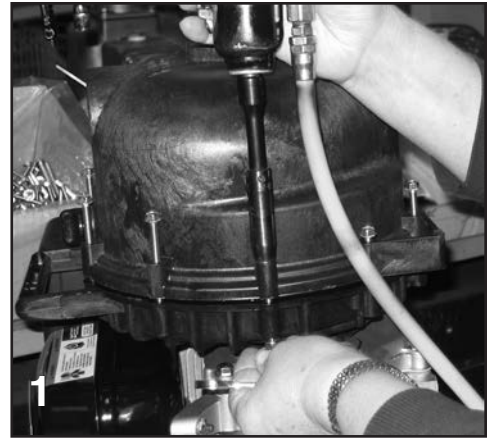

2. Remove the check valve (12705) from the volute (12702A). Remove the one upper volute screw (12900) and the two smaller volute screws (12725) from the volute. Remove the volute from the remaining pump assembly.

For 3" PUMP

Remove the check valve (12705) from the volute (13702). Remove the one upper volute screw (12900) and the two smaller volute screws (12725) from the volute. Remove the volute from the remaining pump assembly.

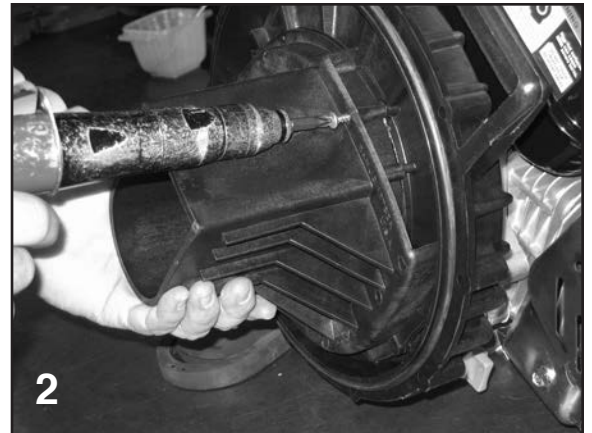

3. Remove the impeller bolt (12765A) from the impeller (12771A/12772). Remove the impeller bolt gasket (12774VA) from the impeller.

For 3" PUMP

Remove the impeller bolt (12765A) from the impeller (13772). Remove the impeller bolt gasket (12774VA) from the impeller.



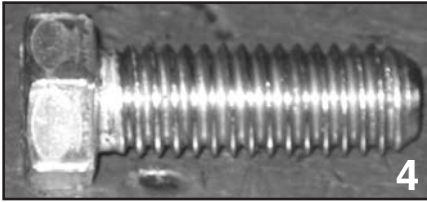

4. Screw the supplied 7/16-14 hex head cap screw into the impeller snout. As the bolt is tightened the impeller will be pried off of the shaft of the drive unit. Remove the 7/16-14 screw once the impeller has been removed from the drive unit.



If the pump impeller is going to be reused the ceramic seal half (12713) should be removed from the impeller at this time. The impeller key (12902A) located behind the ceramic seal half should be replaced at this time also.

5. Remove the four bracket screws (12715A), rear bracket washers (12901), and screw head O-rings (12717) from the rear bracket using a 1/2" socket. With the four bracket screws removed the rear bracket can now be removed from the drive unit.

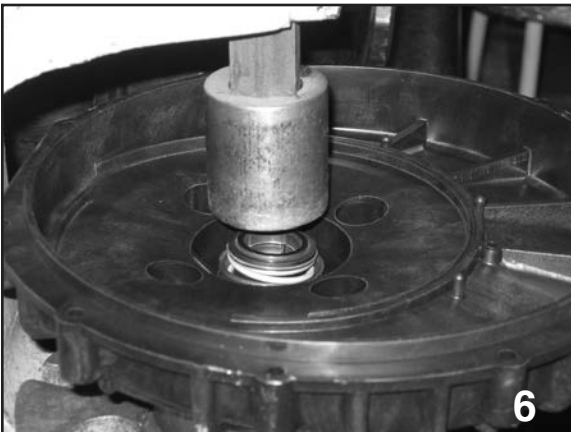

6. Remove the carbon seal half from the rear bracket. This may be done by using a round object such as a wrench socket and tapping it gently with a hammer. The seal is very fragile so take care not to crack the seal if it will be reused.

With the pump completely disassembled; clean all of the reusable parts thoroughly, removing any traces of old gasket material and trapped or dried liquids that were run through the pump.

At this time, it may be necessary to polish the drive unit shaft to remove any corrosion that may have formed.

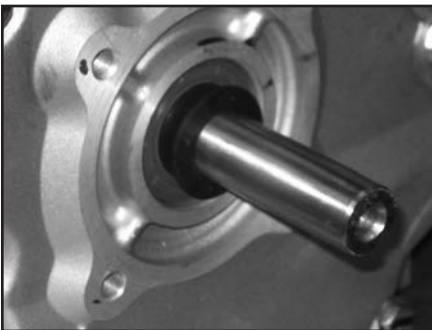

ASSEMBLY INSTRUCTIONS

1. Install the pump slinger (12706) on to the drive unit shaft. The slinger should be slid all the way back on the shaft of the drive unit so that the slinger covers the step on the drive unit shaft as shown.

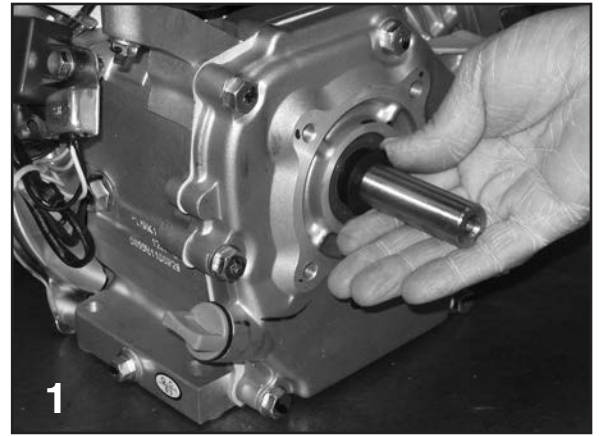

3. Place the seal O-ring (12710) behind the lip of the carbon seal half. The carbon seal half (12713) should now be installed into the rear bracket as shown at right.

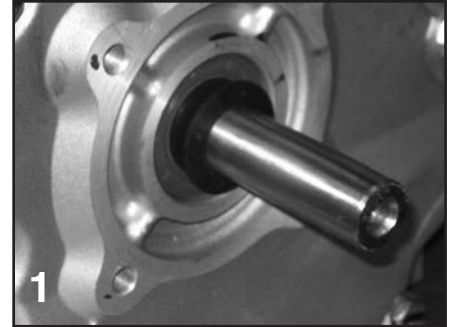

3. To install the carbon seal half into the rear bracket use a tool such as a 1 1/2" pipe nipple or arbor press to give even pressure on the metal flange of the seal housing during installation. Gently press the seal into position until it bottoms.

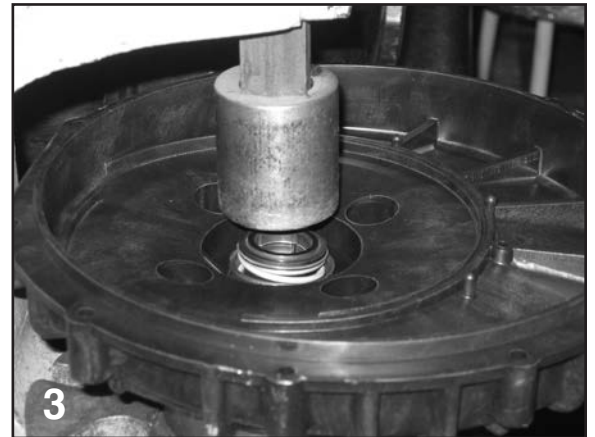

4. Clean the threads of the bracket screws (12715A) thoroughly. Once clean, install the four flat washers (12901) and four screw head O-rings (12717) onto each of the bracket screws.



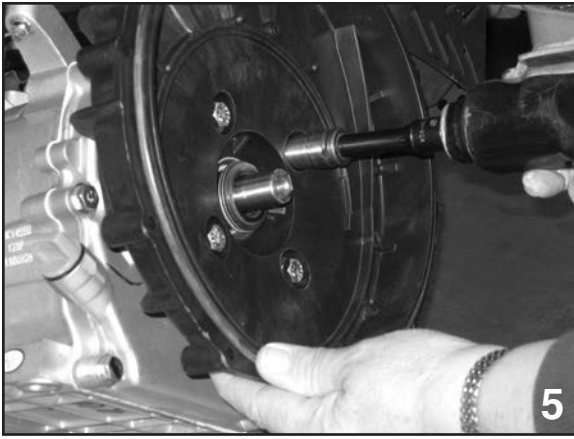

5. Install the rear bracket onto the drive unit using the bracket screw assemblies from the previous step. The handle of the rear bracket should be to the top of the drive unit. Tighten the screws securely.



6. Verify that the impeller hex nut (12775A) is located at the bottom of the impeller snout, it should be installed now. A very light press fit may be required to install the nut into its cavity. Install the ceramic seal half into the impeller. The seal half is pressed into the hub of the impeller by using an arbor press or similar tool that will provide a uniform press fit. The outside diameter of the rubber boot may be sparingly coated with silicone to ease installation. Be absolutely sure that the ceramic seal half is bottomed out and installed squarely. If the installation is not square, seal wobble will occur leading to premature seal failure. Care must be used when handling the seal to not scratch the seal surface.



7. Place the impeller key (12902A) in the slot located inside the impeller snout. The impeller (12771A/12772) is now ready to be slid onto the drive unit shaft.

8. Secure the impeller to the drive unit shaft with the impeller bolt gasket (12774VA) and impeller bolt (12765A). Tighten the impeller bolt until snug.

For 3" PUMP

Place the impeller key (12902A) in the slot located inside the impeller snout. The impeller (13772) is now ready to be slid onto the drive unit shaft. Secure the impeller to the drive unit shaft with the impeller bolt gasket (12774VA) and impeller bolt (12765A). Tighten the impeller bolt until snug.



9. Install the O-ring segment (12754) onto the rear bracket as shown.

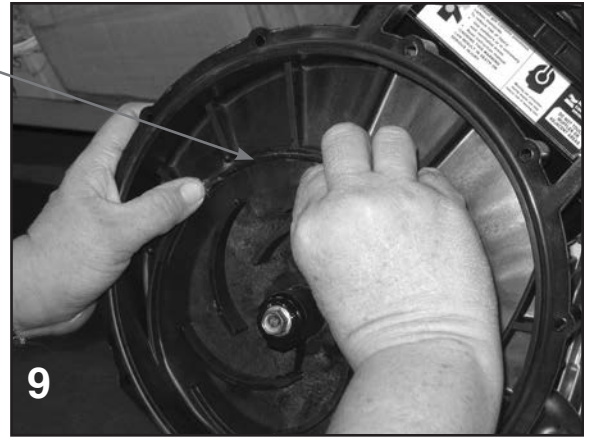

10. Install the volute (12702A) onto the rear bracket using the three volute screws (1-(12900), 20(12725)). Install the check valve (12705) onto the snout of the volute. The drive unit should be turned over a few times to check for clearance between the impeller and volute. A small amount of drag between the impeller and volute will cause no problem, however, if the drive unit will not turn over because of the lack of clearance a bracket shim may have to be used.

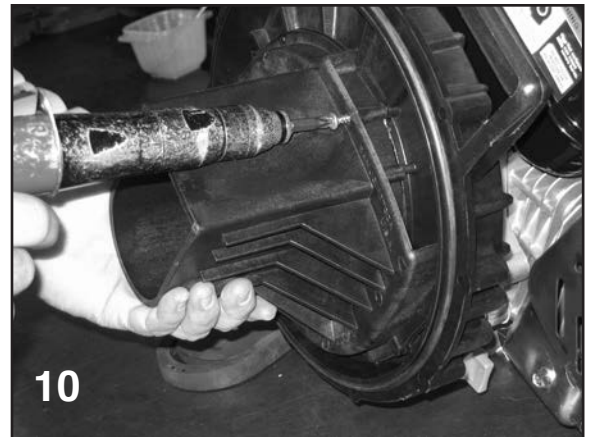

For 3" PUMP

Install the volute (13702) onto the rear bracket using the three volute screws (1-(12900), 20(12725)). Install the check valve (12705) onto the snout of the volute. The drive unit should be turned over a few times to check for clearance between the impeller and volute. A small amount of drag between the impeller and volute will cause no problem, however, if the drive unit will not turn over because of the lack of clearance a bracket shim may have to be used.



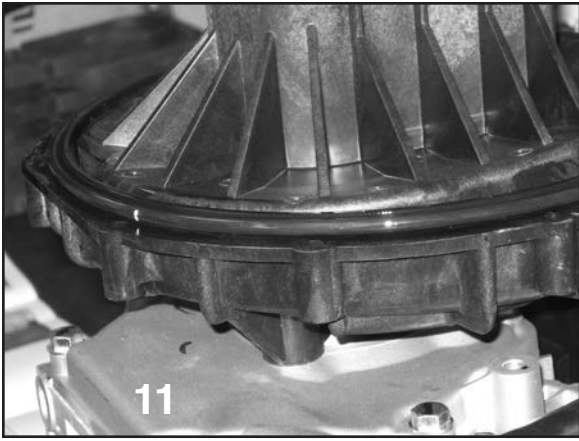

11. Place the pump body O-ring (12719A) around the outside flange of the rear bracket. The O-ring may be sparingly lubricated with silicone to ease installation of the pump body in the next step.

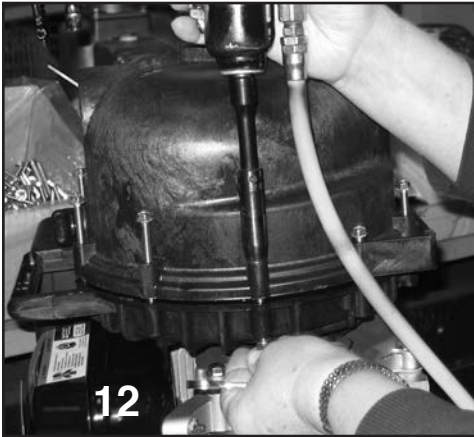

12. Install the pump body (12712) as shown below with the outlet flange facing up. Install the 10 body screws (12720), 10 lock washers (V07018), and 10 nuts (V07019) to secure the pump body to the rear bracket. Tighten the bolts securely all the way around.

For 3" PUMP

12. Install the pump body (13712) with the outlet flange facing up. Install the 10 body screws (12720), 10 lock washers (V07018), and 10 nuts (V07019) to secure the pump body to the rear bracket. Tighten the bolts securely all the way around.



The pump is now ready for operation.

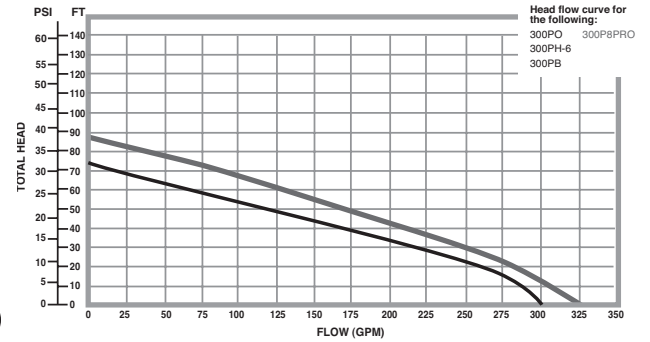
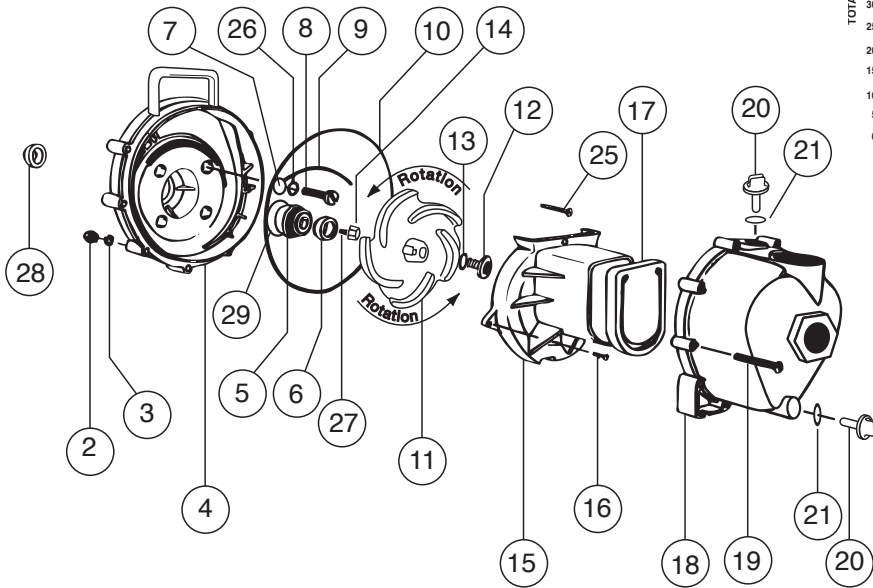

Head (FT)	0	11	23	34	46	57	69	80
Pressure (PSI)	0	5	10	15	20	25	30	35
Flow (GPM)	325	300	280	235	190	150	90	20

Note: Curve based on water and pump spinning at 3450 RPM

Head (FT)	0	11	23	34	46	57	69
Pressure (PSI)	0	5	10	15	20	25	30
Flow (GPM)	300	285	240	190	145	85	15

Note: Curve based on water and pump spinning at 3450 RPM

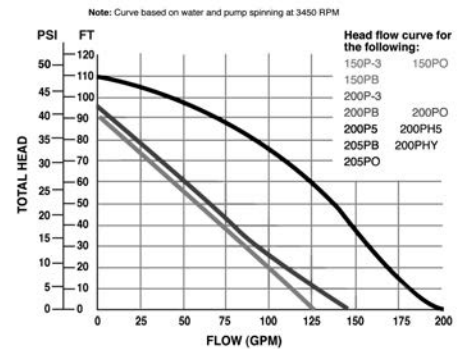

Head (FT)	0	11	23	34	46	57	69	80	92
Pressure (PSI)	0	5	10	15	20	25	30	35	40
Flow (GPM)	125	110	95	80	70	50	30	15	0

Head (FT)	0	11	23	34	46	57	69	80	92
Pressure (PSI)	0	5	10	15	20	25	30	35	40
Flow (GPM)	140	120	105	85	70	50	30	15	0

Head (FT)	0	11	23	34	46	57	69	80	92	103
Pressure (PSI)	0	5	10	15	20	25	30	35	40	45
Flow (GPM)	195	180	170	155	145	125	110	85	60	20

Note: Curve based on water and pump spinning at 3450 RPM

ITEM	DESCRIPTION	QTY.	2" PUMP	1-1/2" PUMP	3" PUMP
2	Body Nuts SS	10	V07019	V07019	V07019
3	Lock Washer SS	10	V07018	V07018	V07018
4	Poly Pump Rear Bracket	1	12703A	12703A	12703A
5 & 6	Seal Assembly*+	1	12713	12713	12713
7	Screw Head O-Ring*+	4	12717	12717	12717
8	Bracket Screw SS	4	12715A	12715A	12715A
9	O-Ring Segment*+	1	12754	12754	12754
10	Body O-Ring*+	1	12719A	12719A	12719A
11	Poly Pump Impeller+	1	12772 (5 Vane)	12771A (3 Vane)	13772
12	Impeller Bolt SS	1	12765A	12765A	12765A~
13	Impeller Bolt Gasket*+	1	12774VA	12774VA	12774VA
14	Impeller Hex Nut	1	12775A	12775A	12775A
15	Poly Pump Volute	1	12702A	12702A	13702
16	Volute Screw SS	2	12725	12725	12725
17	Poly Pump Check Valve+	1	12705	12705	12705
18	Poly Pump Body Assy.	1	12712A	12711A	13712
19	Body Screws SS	10	12720	12720	12720
20	Prime/Drain Plug	2	12777	12777	13777
21	Prime/Drain Plug O-Ring*+	2	UV15163	UV15163	13778
25	Upper Volute Screw SS	1	12900	12900	12900
26	Rear Bracket Washer SS	4	12901	12901	12901
27	Impeller Key	1	12902A	12902A	12902A
28	Poly Pump Slinger*+	1	12706	12706	12706
29	O-Ring for Seal Assy.*+	1	12710	12710	12710
N/S	Bearing Pedestal-3/4" Shaft	1	12882A	12882A	12882A
N/S	Pump Repair Kit (Items +)	1	12000A	12000A	13000
N/S	Pump Seal O-Ring (Items *)	1	12999A	12999A	13999

~Note: 300P8 uses 13765 Impeller Bolt in place of the 12765A Impeller Bolt.
(Viton & Buna Seals available upon request.)