

UPLAY TODAY

COZY POD SPINNER

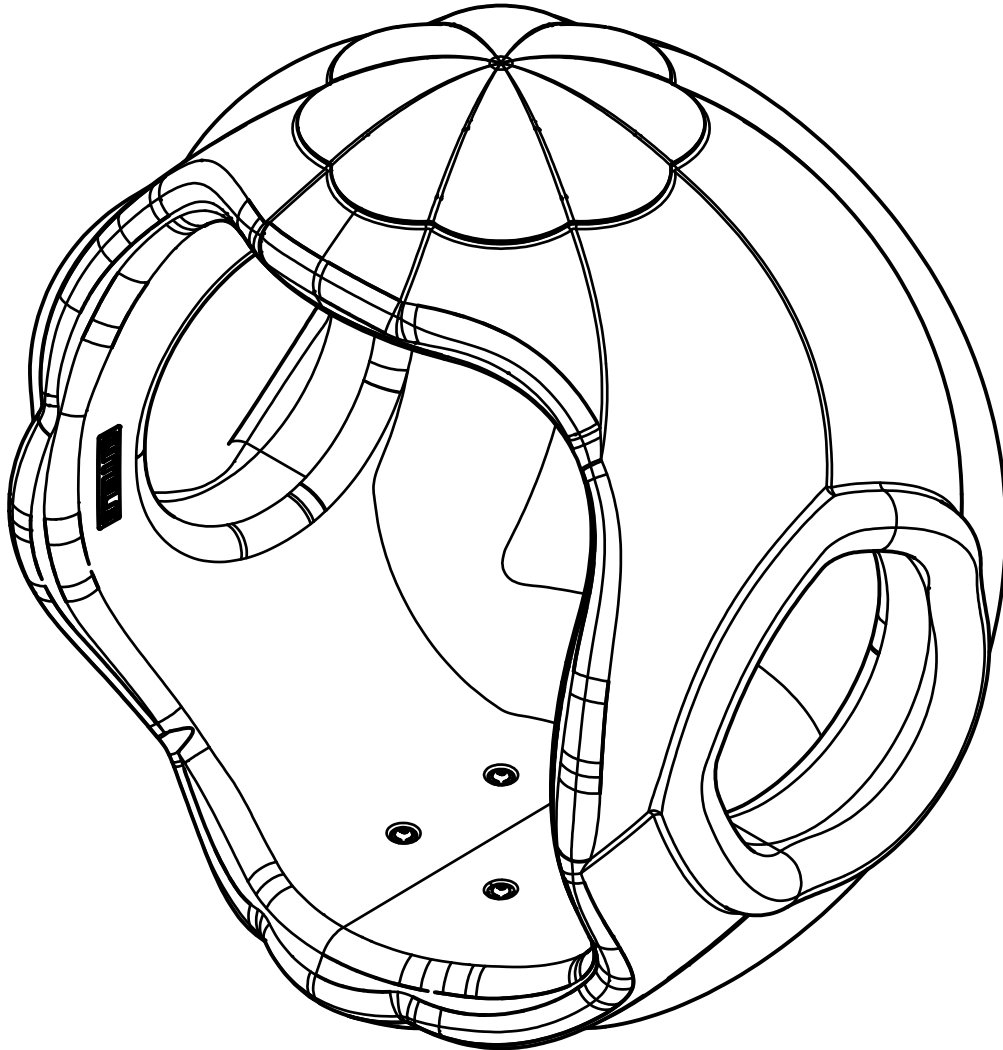

MODEL # UPLAY-033

COZY POD SPINNER

Dear UPlayToday™ Customer,

Thank you for choosing to purchase and install a UPlayToday commercial playsystem by UltraPlay®. We appreciate the confidence you have placed in our company, and we will strive to earn your trust.

This is your Owner's Manual & Assembly Instructions booklet. We have designed this manual specifically for the products that you have purchased. Included in this manual you will find the following:

- Maintenance schedule & record
- Safety guidelines
- Warranty information
- Product installation instructions
- 2D top view drawings
- Ground plan

Please save this booklet for future reference.

The first several pages of this booklet contain important and valuable information regarding the general placement, installation and safety practices common to commercial play equipment. Please read this information carefully and use your best judgment as to how these guidelines apply to your specific situation.

If you have any questions concerning your new equipment, you can contact a UPlayToday Customer Service Representative at 1-800-458-5872 or reach them electronically by sending an e-mail to: customerservice@ultraplay.com.

To register your equipment and activate your warranty, please go to www.ultraplay.com within 30 days of delivery. This will allow UltraPlay to have a record of your purchase in case of warranty claims.

For more information on UPlayToday and UltraPlay products, please do not hesitate to give us a call or visit ultraplay.com.

Thank you for your business; we look forward to working with you on all of your future playground equipment projects!

Sincerely,

UPlayToday by UltraPlay
A PlayCore® Company

GENERAL COMMERCIAL PLAYGROUND SAFETY GUIDELINES

Maintaining your playground equipment and its surrounding area is essential to minimizing the risk of injury to users as well as maximizing its useful lifespan. UPlayToday STRONGLY recommends that you follow these Safety Guidelines in conjunction with conducting periodic maintenance inspections using the accompanying *Playground Maintenance Checklist*.

When installing your playground, always consider local conditions. Good common sense works hand-in-hand with the instructions.

LOCATING YOUR PLAY STRUCTURE:

Comply with the following when choosing the location for your new equipment: Equipment shall be positioned to eliminate conflicting traffic patterns. As a general rule, allow at least 72" of free space around the entire structure, EXCEPT for slide exits, which require a distance X equal to the highest point of the sliding surface with a minimum of 72" and maximum of 96" from the edge of the slide. (example: a Wave Slide from a 72" deck requires 72" of clear space with resilient surfacing in front of its exit.) Swings must have a minimum Use Zone in each direction of twice the swing beam height. This minimum area should be filled with the appropriate resilient surface material. Read further for resilient surfacing recommendations.

If your equipment includes any metal slides, they should be positioned in a shaded area, or at least be placed to avoid the direct rays of the sun.

Never overlap the safety zones of adjacent equipment. All separate play equipment must have its own safety zone, and these cannot overlap. So, if you have an existing structure with a slide exit oriented toward your new one, add a minimum safety zone to that of the existing slide to determine how far away you need to be. Never install playground equipment near, around, or in conjunction with swimming pools, ponds, lakes, or any other bodies of water.

CHOOSING RESILIENT SURFACE MATERIAL:

NEVER INSTALL EQUIPMENT ON CONCRETE, ASPHALT OR EVEN GRASS WITHOUT RESILIENT SURFACING! A fall on a hard surface from as low as a 36" high deck has been found to result in serious injury to the user.

According to ASTM guidelines: "Unacceptable material for use zones of play structures with fall heights of 18" or less shall include all hard or abrasive materials such as asphalt, concrete, terrazzo, or other materials with similar characteristics. "Other standards apply for equipment with fall heights greater than 18".

Soft, resilient surfacing should be placed in the use zones of all equipment, as specified for each type of equipment, and at depths to meet the critical fall heights as specified by the U.S. Consumer Product Safety Commission, ASTM standard F-1487 and Canadian Standard CAN/CSA-Z-614.

Your UPlayToday structure has a maximum fall height of 72".

GENERAL COMMERCIAL PLAYGROUND SAFETY GUIDELINES

Install Wood Mulch (EWF) at a depth of 12". Over time this mulch will compress to a depth of 9" as required by the U.S. Consumer Product Safety Commission, ASTM standard F-1487 and Canadian Standard CAN/CSA-Z-614. For more information on the proper surfacing materials, call the CPSC hotline at 1-800-638-2772.

Worn surfaces around equipment should be restored. Concrete footings should never be exposed. Refer to the attached PLAYGROUND MAINTENANCE CHECKLIST.

Check for erosion and cratering of surfaces under slides and heavy traffic areas and restore surfacing as necessary.

Surfacing leading to play opportunities for children with disabilities should be firm, stable, slip resistant, and resilient.

Tip: If your surfacing is of the loose variety, checking for proper depth over time can be made easy by applying a non-removable fluorescent tape of paint in a bright color at the proper level on each upright post. Thereafter, as the resilient material compacts or washes away, the person responsible for regular maintenance inspections can easily see it must be replenished as the marks become visible.

OVERHEAD OBSTRUCTIONS:

Overhead obstructions (for example, exterior obstructions such as tree limbs and interior lights) within the use zones of play structures shall be a minimum 84" (2130 mm) above each designated play surface outdoors and a minimum of 48" (1220 mm) above each designated play surface indoors.

All overhead utility line clearances above outdoor supervised and outdoor unlimited access settings shall comply with all local, state, and national codes, such as the National Electrical Safety Code. For specific equipment fall zone requirements, refer to the CPSC and ASTM F1487 and use the more stringent of the two.

CATCH POINT & PROTRUDING HARDWARE:

There should be no dangerous pieces of hardware, such as protruding bolt ends and narrow gaps in metal connections. Exposed hardware can cut or puncture skin and catch clothing drawstrings, which could strangle a child.

All protruding nuts and bolts should be eliminated; sharp edges on pipes should be capped or removed. Check for bent, broken, or severely worn pipe and replace. Examine slide bedways, bedrails, handrails and exits for foreign objects, holes, and rough edges.

GENERAL COMMERCIAL PLAYGROUND SAFETY GUIDELINES

TRIPPING HAZARDS:

There should be no exposed concrete footings, abrupt changes in surface elevations, tree roots, tree stumps, and rocks, which can trip children and adults. Check for trip hazards, such as the balance beam support posts, or environmental trip hazards, such as rocks or roots in the play area. Make all necessary improvements or repairs.

AFTER THE EQUIPMENT IS IN USE:

- Never add components not intended for use with this product.
- Never install other play equipment, fencing, landscaping, etc., that encroach upon the safety zones of this equipment.
- Check overall stability and rigidity of all play equipment.
- Check for proper assembly, installation and ground anchoring.
- Check and re-tighten all fasteners after the first few days of use and again after three weeks of use. Thereafter, exercise normal maintenance procedures. Use of a thread-locking compound on the threads of bolts can prevent persistent loosening.

ROUTINE MAINTENANCE:

Regularly inspect and maintain your playground equipment and its surrounding area to help ensure the safety of the user. Proper maintenance of UPlayToday equipment includes using the accompanying **Playground Maintenance Checklist** found in this booklet to identify areas requiring repairs or replacement, and barricading the equipment to prevent use while corrections are being made.

As the Owner/Operator of the equipment, you should establish and maintain detailed installation, inspection, maintenance, and repair records for each public-use playground equipment area. Find out if your playground has a designated official who periodically inspects the play equipment for preventative maintenance. This includes but is not limited to: replacing missing, broken or worn-out components; securing hardware; checking for deterioration in the metal or plastic materials; maintaining the proper depth of surfacing material; and cleaning up debris.

The following are some regular maintenance areas of note:

- Check for and repair damage caused by wear or vandalism, a major factor in injury causing situations.

Continued on next page

GENERAL COMMERCIAL PLAYGROUND SAFETY GUIDELINES

- Proper maintenance of UPlayToday equipment requires regular tightening of all bolts, nuts, set screws, and other hardware.
- All equipment should be free of rust and repainted with an appropriate lead-free paint whenever necessary to deter rusting. This should also be done for any chipped or peeling areas.
- Regular checking of all parts, casting, etc., should be made. If part is broken or worn it should be replaced immediately.
- Check for missing or broken parts, rungs, or steps and repair as necessary.
- Check to be sure there is free movement on moving attached parts.
- Check for hard surfaces and correct, including under slides and etc. where loose surfacing may have been kicked away. *Refer to CPSC surfacing requirements.*
- Check for surfacing material that is worn or scattered and restore.
- Debris, broken glass, trash, or other foreign objects within or on the play area/equipment should be removed.
- Check for poor drainage areas and repair.
- Check concrete footings to see if they are exposed, cracked, or loose in the ground and repair as necessary.
- Check for crush points (exposed mechanisms, junctures of moving components) and eliminate.
- Check for broken supports or anchors. Check for stability in ground. Structures should not be easily swayed; connections should be solid and adequately secured.
- Check all posts in ground for corrosion or rot below grade.
- When flexible components are anchored in the ground, check and make sure anchoring devices are below the level of the playground.
- Check exit areas of slides. The exit area should be no more than 11" from the protective surface for slides under 48" high. For slides over 48" high, the height of the exit region from the surface should be between 7" and 15".
- Check the surface area around slide exit for erosion and other damage and repair if necessary.
- Check for visible cracks, bending, warping, rusting, or breakage of any component and repair as needed.

GENERAL COMMERCIAL PLAYGROUND SAFETY GUIDELINES

- Check for accessible sharp edges or points. Check for protruding bars, bolts, nuts, etc. Eliminate these conditions.
- Check for exposed ends of tubing that should be covered with plugs or caps.
- Check for loose bolts, nuts, etc. and tighten.
- Check for broken or missing rails, steps, rungs, or seats and replace.

MAINTENANCE CHECKLIST



Maintaining your playground equipment as well as its surrounding area is essential to minimizing the risk of injury to users as well as maximizing its useful lifespan. UltraPlay recommends the following maintenance procedures be followed:

On a daily basis: A responsible individual should conduct a brief visual check for structural defects, signs of vandalism and litter of foreign matter that needs to be removed.

On a weekly basis: A responsible individual should complete this checklist. Any required repairs should be detailed on the separate **Detailed Maintenance Record**, and once they are completed, both should be filed for future reference. A separate file and form should be kept for each play structure at each location.

IMPORTANT: Always refer to - and comply with - the separate Safety Guidelines and ASTM and CPSC Guidelines. The play structure(s) should be barricaded so that it cannot be used while repairs are being completed.

	Item to be Checked (use the following page to record a brief description of the necessary repairs)	OK	Repairs Required	Date Repaired
A.	Play Structures in General			
	1. Post and component footings are not exposed, cracked or loose			
	2. Welds are intact and free of cracks			
	3. No rust or corrosion			
	4. No splintered, cracked, gouged or otherwise deteriorated plastics; check for integrity of the plastic, keep plastic clean of any extraneous substances, verify that any deformation does not create entrapment as specified on ASTM-F-2373.			
	5. No scratched, chipped or peeling paint			
	6. Metal parts show no visible cracks, bending, warping or breakage			
	7. No missing bolts, nuts, etc.			
	8. All bolts, nuts and fasteners are tight			
	9. All joints are secure (pay special attention to flush-mounted decks and pipe connections)			
	10. No broken or missing parts			
	11. No sharp edges or unsafe protrusions (check metal corners, bolts, etc.)			
	12. No exposed mechanisms, junctions of moving parts or components that will pose possible pinch or crush points			
B.	Play Events			
	1. Plastic is not cut or cracked			
C.	Surrounding Area			
	1. Resilient surfacing material is not scattered or excessively worn			
	2. Resilient surfacing material is adequately deep and retains its fall absorbing abilities as specified at time of installation			
	3. Border around playground is in good condition and has not come loose			
	4. No roots, rocks or other objects that may cause a tripping or injury hazard			
	5. Area is clean of litter (no broken glass or bottles, etc.)			

ultraPLAY

A PLAYCORE[®] Company

UPlay Today™ Limited Warranties

Ten Years

Upright Posts:
Materials &
Workmanship

Five Years

Metal & Ground
Mount Metal Parts:
Materials &
Workmanship

One Year

All Products:
Materials &
Workmanship

All warranties specifically exclude damage caused by man-made or natural disasters, vandalism, negligence, improper installation or improper use, modification, changes in appearance resulting from weathering, scratches, dents, discoloration, normal wear and tear, or marring as a result of public or private use.

Claims are limited to replacement of equipment only and do not include any costs associated with labor, removal or installation of the original or replacement product.

Warranties are valid only if products are installed and maintained in accordance with UltraPlay installation instructions and use of approved parts.

UPLAY TODAY WARRANTY

UltraPlay warrants its products to be free from defects in materials and/or workmanship, subject to normal usage and installation, for a period of 1-year from the date of shipment to the original purchaser. In the event of a claim under this warranty, UltraPlay will replace the component at no cost within the first 12 months from date of shipment to the original customer. Equipment not specifically addressed in the following paragraphs is also subject to this limited 1 year warranty against defects in materials and/or workmanship.

TEN-YEAR LIMITED WARRANTY ON UPRIGHT POSTS

UltraPlay provides a limited warranty on metal upright posts to be free from defects in materials or workmanship against structural failure which causes the product to become unfit for its intended use, subject to normal usage and installation, for a period of 10 years from the date of shipment to the original customer.

FIVE-YEAR LIMITED WARRANTY ON METAL PARTS

UltraPlay provides a limited warranty on metal decks, steps, stairs, rails, pipes, support posts, rungs, loops, and clamps to be free from defects in materials or workmanship against structural failure which causes the product to become unfit for its intended use, subject to normal usage and installation, for a period of 5 years from the date of shipment to the original customer.

FIVE-YEAR LIMITED WARRANTY ON GROUND-MOUNT METAL PARTS

UltraPlay provides a limited warranty on metal footers, inground footers, surface mount plates, ground spikes, slide and climber mounting posts and plates to be free from defects in materials or workmanship against structural failure which causes the product to become unfit for its intended use, subject to normal usage and installation, for a period of 5 years from the date of shipment to the original customer.

THREE-YEAR LIMITED WARRANTY ON PLASTIC PARTS

UltraPlay provides a limited warranty on the following plastic parts: slides, climbers, roofs, tunnels, bridges, panels, and border timbers. These components are warranted to be free from defects in material or workmanship, subject to normal usage and installation, for a period of 3 years from the date of shipment to the original customer.

ONE-YEAR LIMITED WARRANTY ON HARDWARE

UltraPlay Systems provides a limited warranty on hardware to be free from defects in materials or workmanship against structural failure due to breaking or shearing, subject to normal usage and installation, for a period of 1 year from the date of shipment to the original customer.

ONE-YEAR LIMITED WARRANTY ON HDPE CLIMBER

UltraPlay provides a limited warranty on high density polyethylene (HDPE) climber against degradation for a period of 1 year from the date of shipment to the original customer.

WARRANTY EXCLUSIONS

All warranties specifically exclude damage caused by man-made or natural disasters, vandalism, negligence, improper installation or improper use, modification, changes in appearance resulting from weathering, scratches, dents, discoloration, normal wear and tear, or marring as a result of public or private use.

Claims are limited to replacement of equipment only and do not include any costs associated with labor, removal, or installation of the original or replacement product.

Warranties are valid only if products are installed and maintained in accordance with UltraPlay installation instructions and use of approved parts.

This warranty is applicable to the original owner only. Warranties are non-transferable.

Claim Procedure: To make a warranty claim, send your written statement of claim, photographs of defective equipment, and the original purchase invoice or invoice number to:

UPlayToday
Customer Service
1675 Locust Street
Red Bud, IL 62278

Or Contact a Customer Service Representative at: **1-800-458-5872**

Within 60 days of notice of claim under warranty, UltraPlay will make arrangements to replace the damaged product. UltraPlay will cover freight costs within the continental United States. UltraPlay is not responsible for freight costs associated with products located outside the continental United States. UltraPlay reserves the right to inspect all products identified as defective. Photos of defective equipment may be required to accompany warranty claims.

Since warranty limitations and exclusions may vary from state to state, you should check any specific warranty rights in your state.

Date of Purchase: _____

Purchaser: _____

UltraPlay Invoice Number: _____

Authorized UltraPlay Signature

Title

Visit UltraPlay on the web at www.ultraplay.com

Issued/Revised: 6/22/2020



GENERAL INTRODUCTION TO INSTALLATION INSTRUCTIONS

IMPORTANT! Please read the entire Installation Instructions packet before beginning the installation.

UltraPlay has designed UPlayToday to take advantage of all Consumer Product Safety Commission (CPSC) and ASTM guidelines in force at the time of purchase in an effort to prevent playground accidents. However, because studies have shown most playground injuries result from accidental falls, you, as the new owner of this equipment are responsible for providing an acceptable play surface under and around all playground equipment. Please refer to the accompanying Safety Guidelines as well as CPSC guidelines and this document for examples of such surfacing.

We would like to provide the following suggested guidelines for your play environment:

- Refer to the Use Zone and note the Minimum Area required shown for this structure. This area must be filled with acceptable play surface material, and must be clear of all obstacles, including but not limited to trees, curbing, sidewalk, fence, other play equipment, rocks, and landscaping, etc.
- According to ASTM guidelines: "Unacceptable materials for use zones of play structures with fall heights of 18" or less shall include all hard or abrasive materials such as asphalt, concrete, terrazzo, or other materials with similar characteristics." Other standards apply for equipment with fall heights greater than 18".
- Acceptable play surfaces include: sand, mulch, fine gravel or shredded belt-less tires, if installed at the appropriate depths per CPSC guidelines for play surfacing.
- When using sand, mulch, or shredded belt-less tires, a minimum of 6" depth is recommended by the CPSC. UPlayToday recommends an additional 6", for a total of 12", to combat the fast compacting characteristics of these materials. Surfaces must be checked at least weekly for compacting, which reduces resiliency significantly.
- Surfaces such as asphalt, concrete, gravel, or sod are not acceptable for use under playground equipment, or anywhere within the stated Use Zone.
- Unitary resilient surfacing designed for playground use, including rubber tiles, poured-in-place rubber surfacing, bonded rubber surfacing, and synthetic playground turf is also recommended.
- Close supervision of children playing on or around the structure is strongly recommended, along with classroom and/or home instructions on safer behavior on the playground equipment. The full supervision of playgrounds is the responsibility of the owner once the play structure has been properly installed.

Continue on next page

GENERAL INTRODUCTION TO INSTALLATION INSTRUCTIONS

TOOLS REQUIRED:

UltraPlay supplies only the special wrenches and bits required to fasten the "tamper-resistant" hardware and components. You will need common wrenches and an Allen key set as well as a drill, string line, level, shovels, post hole digger, pry bar, washable felt tip marker, phillips head screw driver, utility knife, rubber mallet, and a tape measure. A power post hole digger may facilitate installation in some circumstances. Refer to the Tools Required page for a detailed list.

INSTALLATION GUIDELINES:

1. Compare all parts received to the packing list. Notify UltraPlay immediately of any missing parts. We are not responsible for parts discovered missing over 10 days after receipt of the shipment.
2. Refer to the Use Zone to ensure this structure will fit into your actual site area. Note the Minimum Area Required measurements to determine clear space required. A minimum of 72" clearance is required between any obstacles and your structure. EXCEPT for slide exits, which require a distance X equal to the highest point of sliding surface with a minimum of 72" and a maximum of 96" from the edge of the slide (example: A Wave Slide from a 72" high deck requires 72" of clear space with resilient surfacing in front of its exit).
3. Site selection should include considerations of what is a safe and appropriate play area:
 - A level and clear site is ideal, free of power lines or electrical equipment.
 - Do not install play equipment near any bodies of water.
 - If adjacent to a street with traffic, ensure adequate fencing acts as a barrier to children running into danger.
4. Site layout should include accurate measurement and marking of all footings prior to any installation. Use the dimensions shown between footings on the Use Zone to plot out the actual footprint of the play structure before doing any digging. Also locate any freestanding play equipment in the same way, providing the necessary clearance between the equipment as well as any fences, trees, etc. Ensure at this time you have enough total space for the equipment to be installed.
5. If using inground footers, excavate holes as shown in the Use Zone using a string line. An optional string line level is very helpful. If a level and clear site is not possible, adjust the depth of the footings to maintain a minimum depth of 18" for support posts at the lowest grade. NOTE: If soil conditions are very loose or otherwise unstable, a larger diameter footing may be required. Inquire with local contractors for appropriate recommendations.
6. Begin your UPlayToday installation by erecting the decks as shown within the following instructions. Once all decks are installed, components such as slides, climbers, etc., can be connected per their respective assembly instructions. Note that connecting components between decks such as Crawl Tunnels and Bone Bridges should be installed concurrently with the decks to ensure they are accurate.

GENERAL INTRODUCTION TO INSTALLATION INSTRUCTIONS

7. CPSC guidelines mandate that there shall be no gaps present in the playground equipment that fall between 3-1/2" and 9". The positioning of certain components by the installer can affect this criteria, so you should always measure distances created when attaching components in order to avoid these spaces which can cause entrapment of a child using the equipment. Also, ASTM requires that no more than 2 threads of a bolt can protrude from the nut. Any excess threads should be filed down and made smooth to the touch.
8. When concrete is poured, be sure to keep the top 4" below grade, and sloped away from the post to promote good water drainage. Wash off any concrete that may have splashed onto the post before it dries. Allow all concrete to harden a minimum of 48 hours before allowing use.

SAFETY DURING INSTALLATION:

1. Before doing any excavation, inquire about any existing underground utilities.
2. Do not leave the job site unattended without making sure that all fastening hardware on all equipment is tightened and all drive rivets are in place to prevent clamps from moving, in case of unauthorized use. UPlayToday CLAMPS ARE NOT DESIGNED TO SUPPORT HUMAN WEIGHT WITHOUT THE DRIVE RIVETS INSTALLED, AND SUCH USE COULD CAUSE INJURY TO THE USER AND/OR DAMAGE TO THE EQUIPMENT. It is also strongly recommended that all installation areas be roped off with clearly marked warning signs posted. Any open footings should be covered with plywood or other suitable material. Even during installation, it has been found that children will use the unattended equipment, thereby risking accidents.
3. If concrete footings and inground footers are being used, it is strongly recommended that the installation area should remain roped off for at least 48 hours after the last concrete footing is poured. Children should not be allowed to use the equipment during this period so that concrete has a chance to fully cure.

Finally, if you should have any questions regarding the proper installation of this equipment, please contact UltraPlay at:

UPlayToday Customer Service
1675 Locust Street, Red Bud, IL 62278
1-800-458-5872 Fax 1-618-282-8202
Email: customerservice@uplaytoday.com

GENERAL INTRODUCTION TO INSTALLATION INSTRUCTIONS

The enclosed Warning Labels must be affixed to your playground equipment. At least one Warning Label is needed per play structure, permanently affixed in a conspicuous location within easy view of users.

INSTRUCTIONS:

1. Fully assemble and install your UPlayToday playground equipment per the accompanying installation instructions.
2. When installation of the equipment is complete, and prior to allowing use of the equipment, identify a suitable location on the structure to receive the Warning Label. An upright post is recommended, approximately 48" above the ground. Choose an upright post most likely to be seen by the user immediately upon entry into the play area.
3. Fully clean the surface to receive the label with soap and water, and ensure that no oils, film, or dirt remain.
4. Allow surface to dry fully. Apply the Warning Label, smoothing over the surface with a clean cloth so there are no air bubbles present.
5. For larger structures (more than 16 upright posts), use 2 labels, positioning one at each end of the structure. Always choose locations, which are likely to be seen by users prior to use of the equipment, preferably near the entry point of the play area.

ALWAYS FOLLOW THE RECOMMENDATIONS CONTAINED IN THE ACCOMPANYING SAFETY GUIDELINES REGARDING THE INSTALLATION AND MAINTENANCE OF APPROPRIATE RESILIENT SURFACE MATERIALS REQUIRED FOR YOUR PLAY AREA. NEVER ALLOW USE OF PLAYGROUND EQUIPMENT WITHOUT PROPER SAFETY SURFACING AS FALLS ONTO A HARD SURFACE CAN CAUSE SERIOUS INJURY TO THE USER.

TOOLS REQUIRED

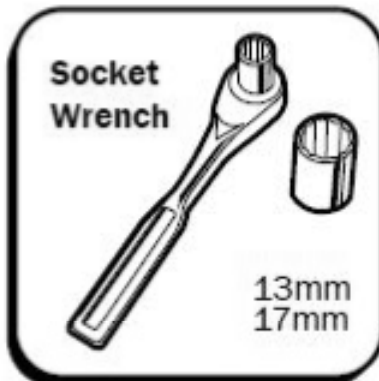
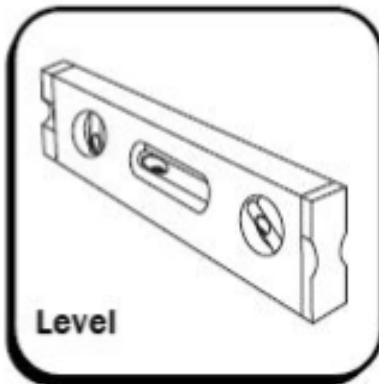

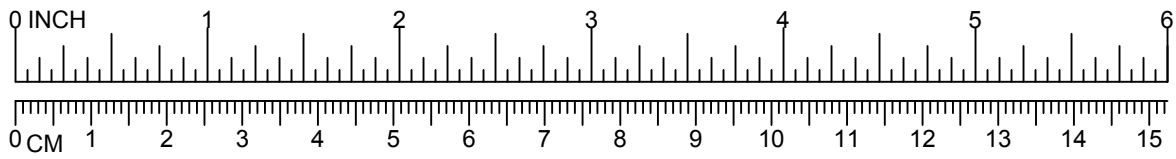

HARDWARE REFERENCE

M8 B.H.C.S. Bolts

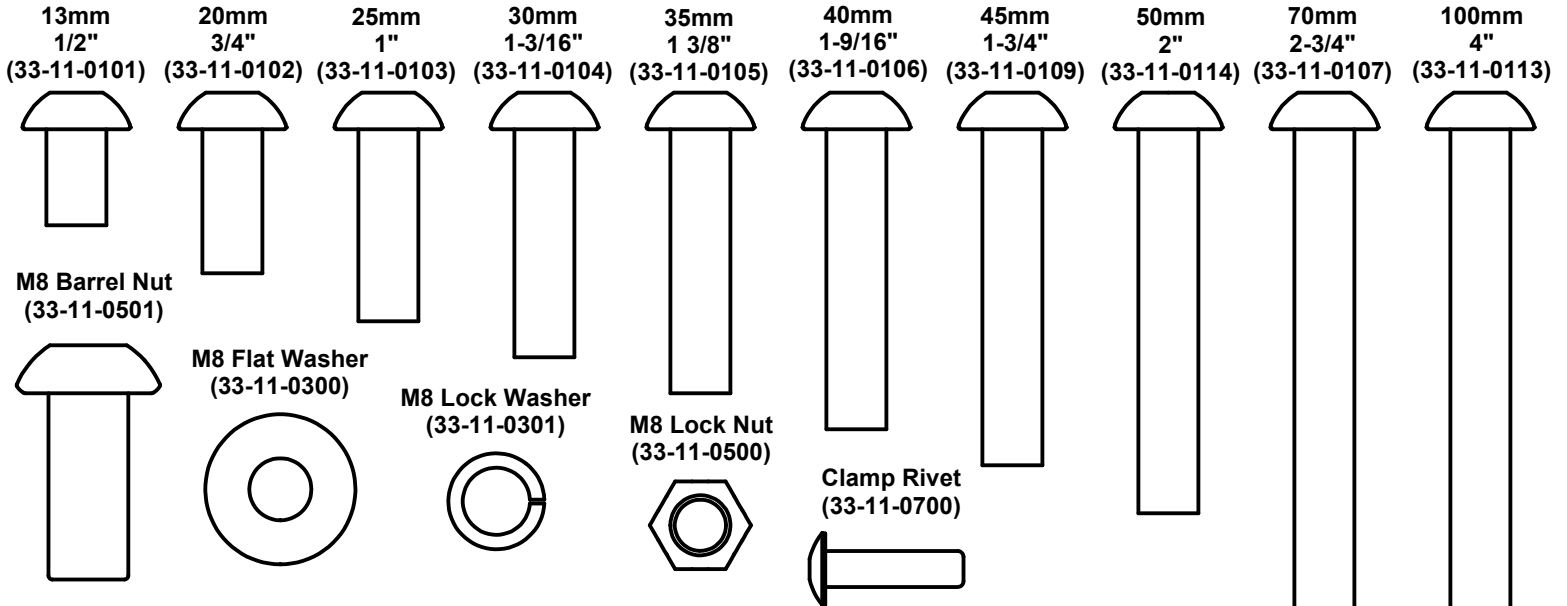

18" Ground Spike (Not to Scale)
(02-07-0048)

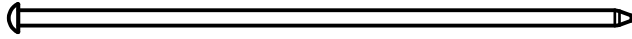

M5 x 76mm (3") Self-Tapping Screw
(33-11-0600)

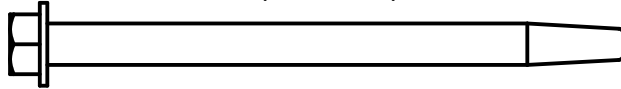

M10 Lock Washer
(33-11-0201)

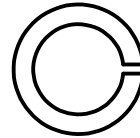

M10 Flat Washer
(33-11-0200)

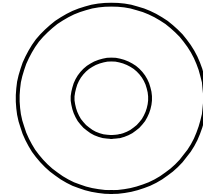

M10 Lock Nut
(33-11-0400)

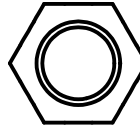

M10 T-Nut
(33-11-0402)



80mm
3-1/8"
(33-11-0011)

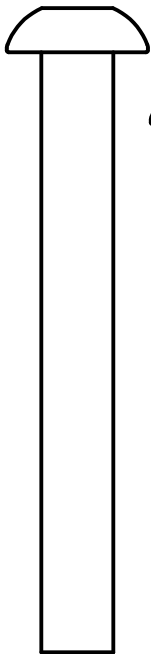

70mm
2-3/4"
(33-11-0008)

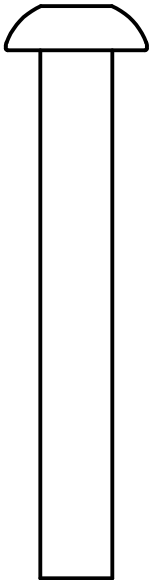

60mm
2-3/8"
(33-11-0007)

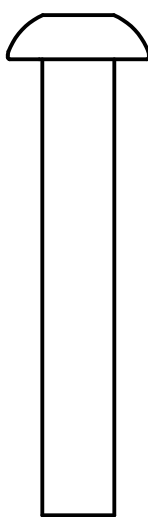

50mm
2"
(33-11-0010)

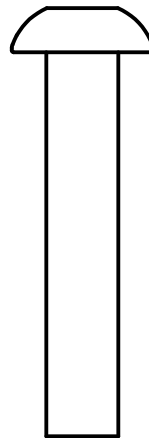

45mm
1-3/4"
(33-11-0013)

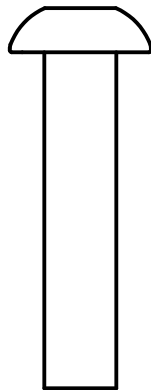

40mm
1-9/16"
(33-11-0006)

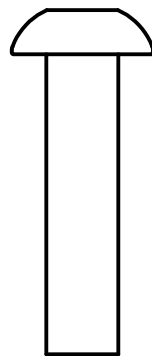

35mm
1-3/8"
(33-11-0005)

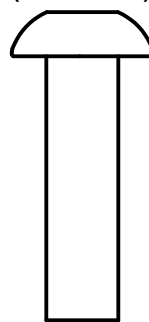

30mm
1-3/16"
(33-11-0004)

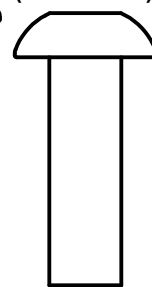

25mm
1"
(33-11-0003)

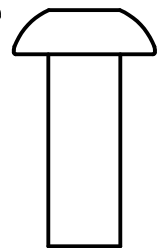

13mm
1/2"
(33-11-0001)

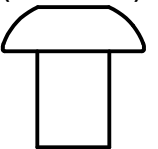

20mm
3/4"
(33-11-0002)

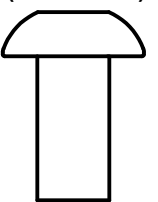

USE ZONE

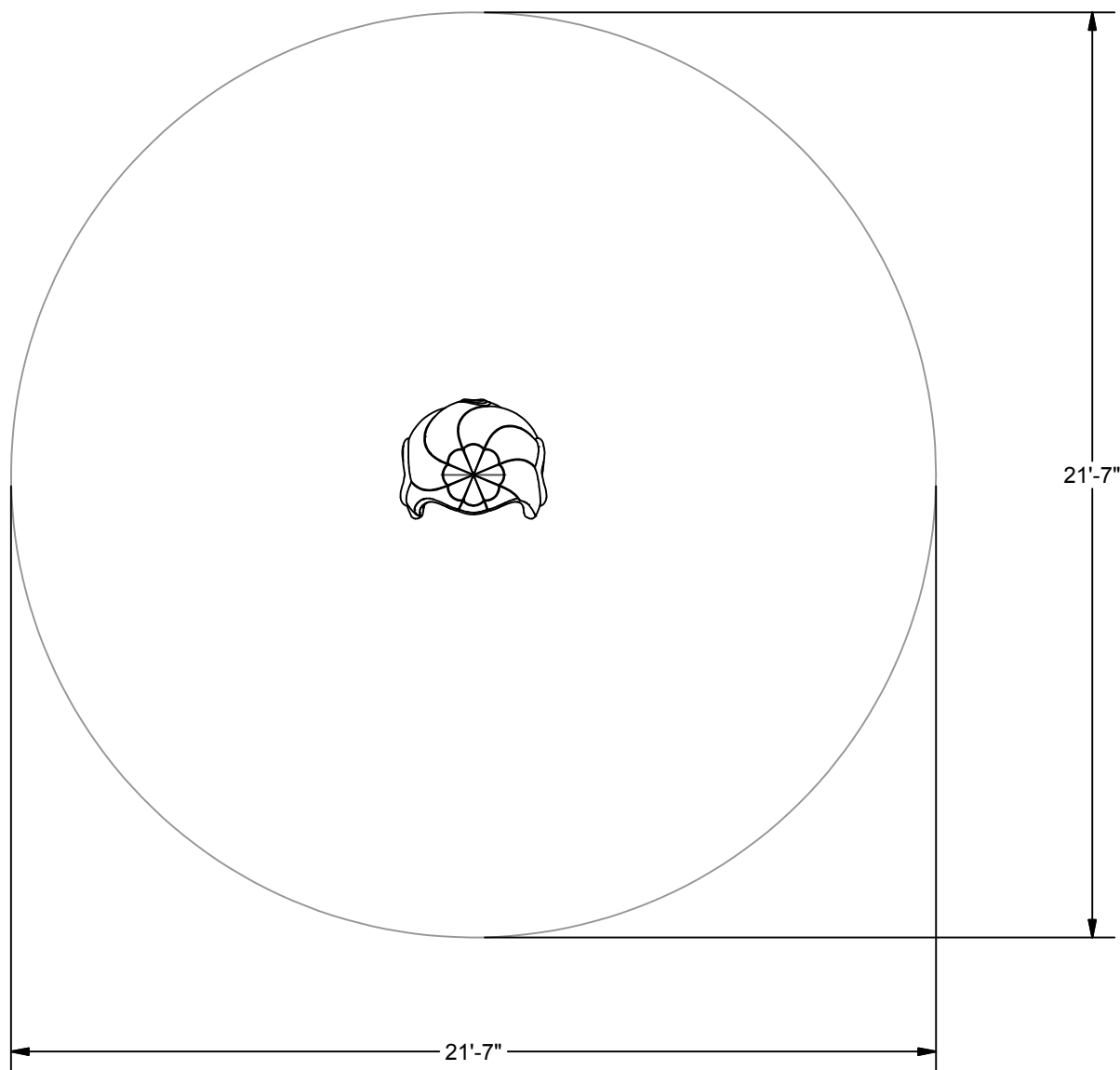

MINIMUM USE ZONE* REQUIRED

**The USE ZONE is the area beneath and immediately adjacent to a play structure or equipment that is designed for unrestricted circulation around the equipment and on whose surface it is predicted that a user would land when falling from or exiting the equipment.*

NOTE:

Equipment shall be positioned to eliminate conflicting traffic patterns. As a general rule, allow at least 3' of freespace around the entire structure.

IMPORTANT: Never install play equipment over hard, unresilient surfaces such as asphalt, concrete, or compacted earth. It is the owner's responsibility to ensure the "minimum area required" contains an appropriate amount of resilient material to cushion accidental falls.

ELEVATION VIEW

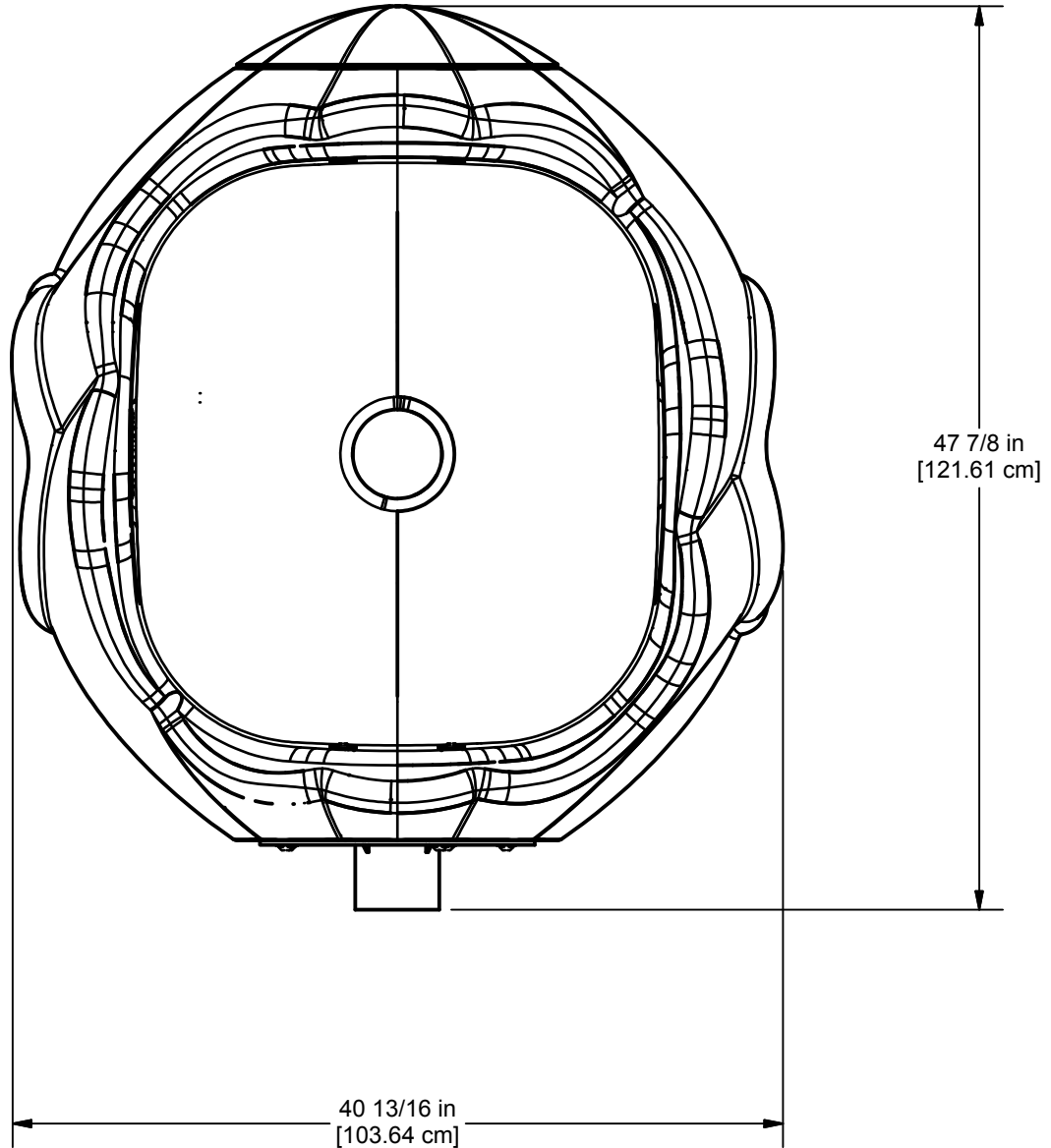

ELEVATION VIEW

UPRIGHT PLACEMENT

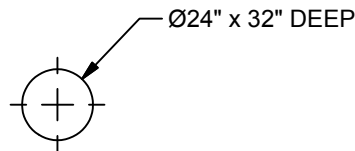

IMPORTANT: Never install play equipment over hard, unresilient surfaces such as asphalt, concrete, or compacted earth. It is the owner's responsibility to ensure the "minimum area required" contains an appropriate amount of resilient material to cushion accidental falls.



Placement for
24" Diameter x 32" Deep Holes
for In-ground installation

NOTE:

All dimensions are measured from the center of the posts/holes

IMPORTANT:
**POURING CONCRETE IS THE VERY
LAST STEP!**

Concrete Required (if applicable):

Approx: 0.310 Cubic Yards (0.237 Cubic Meters)

NOTE: Suggested Min. concrete
rating: 3000PSI

FOOTING DETAIL - INGROUND

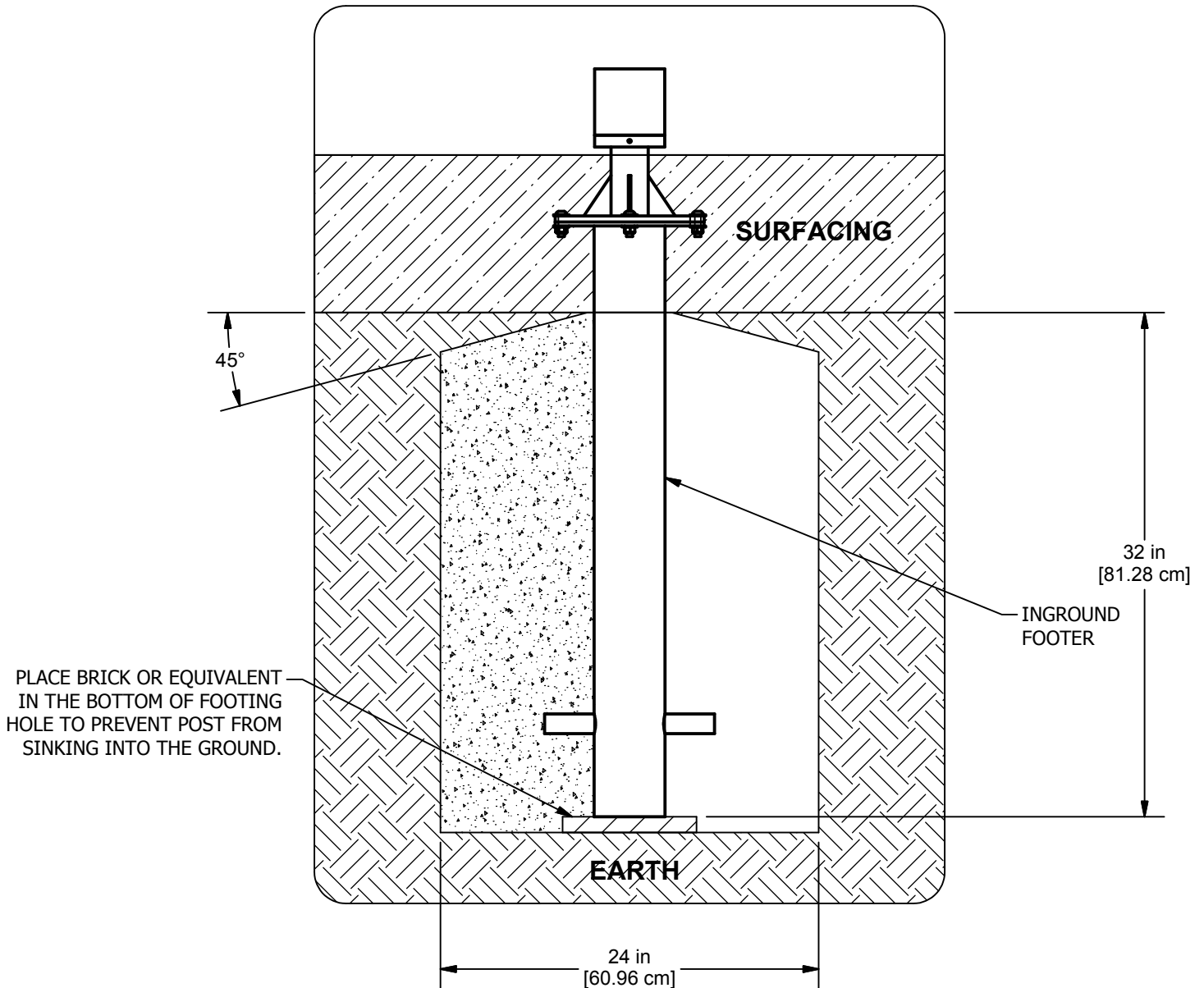

IMPORTANT: Never install play equipment over hard, unresilient surfaces such as asphalt, concrete, or compacted earth. It is the owner's responsibility to ensure the "minimum area required" contains an appropriate amount of resilient material to cushion accidental falls.

SITE PREPARATION

Clear area of any debris and level surface. Equipment is designed to be installed on a level surface.

COZY POD SPINNER

Parts List		
DESCRIPTION	QTY	PART NUMBER
COZY POD SPINNER	1	02-07-0265
INGROUND FOOTER	1	02-07-0266
HARDWARE COMPLETE	1	33-12-0174
M10 x 35mm (1 3/8") BHCS BOLT	4	33-11-0005
M10 FLATWASHER	8	33-11-0200
M10 LOCK NUT	4	33-11-0400

Unless Otherwise Specified, All Units of Measure are Each

Items listed below Hardware Complete line are included with Hardware Complete Number

Warning: During Installation, Hardware And Small Parts Are Choking Hazards For Young Children. Store Unused Parts Appropriately Until Assembly Is Completed. Once Assembly Is Completed, Remove Any Unused Parts From The Play Environment And Dispose/Save Them In A Secure Location. Any bolt end protruding more than two full threads beyond the face of the nut causes risk of clothing entanglement. Promptly cut-off flush, file smooth, and treat to prevent corrosion.

Note: Peen Tee-Nuts and Flatwashers to match radius of pipe after assembly is complete.

Note: Loctite (supplied by others) should be used on any non-patch hardware.

SPECIFICATIONS:

Cozy Pod Spinner:

Shall be 3/8" wall thickness double wall construction, color impregnated linear low density polyethylene and shall conform to the rotationally molded specifications outlined herein. All polyethylene shall be linear low-density material with UV-stabilized color and an anti-static compound additive. All rotationally molded products shall meet or exceed the following specifications: ASTM D-1248, type 2, class A and Federal specification LP-390C, type 1, class M, grade 2, category 3; Density (ASTM D- 1505); Brittleness Temperature (ASTM D-746); Tensile Values (ASTM D-638); Flexural Modulus (ASTM D-790); Heat Distortion (ASTM-648); Low Temperature Impact (ARM-STD). Handholds shall be fabricated from a hybrid resin mixture with custom formulated UV inhibitor.

Powder Coat Finish:

Shall be an electrostatically applied custom formula of TGIC polyester powder. All components will be free of sharp edges and excess weld spatter and shall be cleaned in a four stage solvent/zirconium based bath system (free of iron phosphate), as a rust inhibitor, and a zirconium conversion coating to prevent flash rusting before coating. In addition, all welds shall be protectively coated with ZRP, a zinc rich primer that forms a rust-resistant barrier layer over each weld prior to application of the powder coating. The powder coating shall have a super tough finish with maximum exterior durability and will have superior adhesion characteristics. Typical characteristics are: Two coat process to achieve 3.0 - 5.0 mil thickness and oven cured between 375 to 425 degrees Fahrenheit. Pencil Hardness H (ASTM D-3363), Impact (ASTM D-2794-69), Wedge Bend (ASTM D-522-68), Adhesion (Cross Hatch ASTM D-3359 & Knife Scratch ASTM D-2197), Environmental (Stain Resistance ASTM D-1308, Humidity ASTM D-2247-87, Salt Spray ASTM B-117 & Fadometer 300 hrs with no loss of gloss), Over-bake Stability 200% at 350 degrees Fahrenheit for 10 minutes.

Hardware:

All nuts, bolts, screws, inserts, and lock washers used in the assembly of all play equipment shall be stainless steel, yellow dichromate plated steel, blue-coat plated steel, mechanically galvanized or powder coated/yellow dichromate plated steel. All primary fasteners shall be 304 alloy stainless steel. Fasteners with yellow dichromate treatment have an electro-deposited, 99.9% pure zinc substrate applied from a specially formulated solution sealed with a yellow dichromate top coat designed to work in conjunction with the zinc plating. Yellow dichromate has a 320% longer life to white corrosion and 275% longer to red corrosion than does hot-dip galvanizing. Stainless steel fasteners shall be button pin-in head, hex socket cap screws with a two-part epoxy locking patch added to the threads. The two-part locking patch shall consist of one part resin and one part catalyst which are activated during installation. After curing, the material shall require a minimum of five times the installation torque to remove the fastener. Manufacturer shall provide special installation tools for pinned fasteners.

INSTALLATION INSTRUCTIONS

INSTALLATION INSTRUCTIONS:

1. Determine the location of the Cozy Pod Spinner and dig the footing hole as shown in the Top View. Refer to the Elevation View for footing depth.
2. Attach Cozy Pod Spinner to Footbuck using M10 x 35mm (1 3/8") BHCS Bolt, M10 Flatwasher, and M10 Lock Nut. See Detail 071.
3. Plumb and level the entire assembly and tighten all fasteners.
4. After entire unit is assembled, pour concrete footings within 4" to the top and taper away from post for water drainage. Allow to cure at least 48 hours before use. Temporary bracing may be required until concrete cures.
5. Check that all hardware connections are securely tightened. Smooth away any sharp edges that may have been created during handling and assembly. Install resilient surfacing within the use zone of play structure in accordance with ASTM specifications F1292, and appropriate for the fall height of each structure. Refer to all applicable safety guidelines.

MAINTENANCE PROCEDURE:

Periodically check hardware for tightness, and tighten as necessary. Always check all parts for breakage or wear, and immediately put equipment out of service until any faulty parts found are repaired or replaced. Also Check all metal parts for rust, paint loss and touch-up if necessary with paint. Check for welded areas and verify integrity. Check periodically resilient surfacing for appropriate depth and remove extraneous materials that could cause injury, infection, or disease. Maintain detailed installation, inspection, maintenance, and repair records for each public-use playground equipment.

COZY POD SPINNER

COZY POD SPINNER
(02-07-0265)

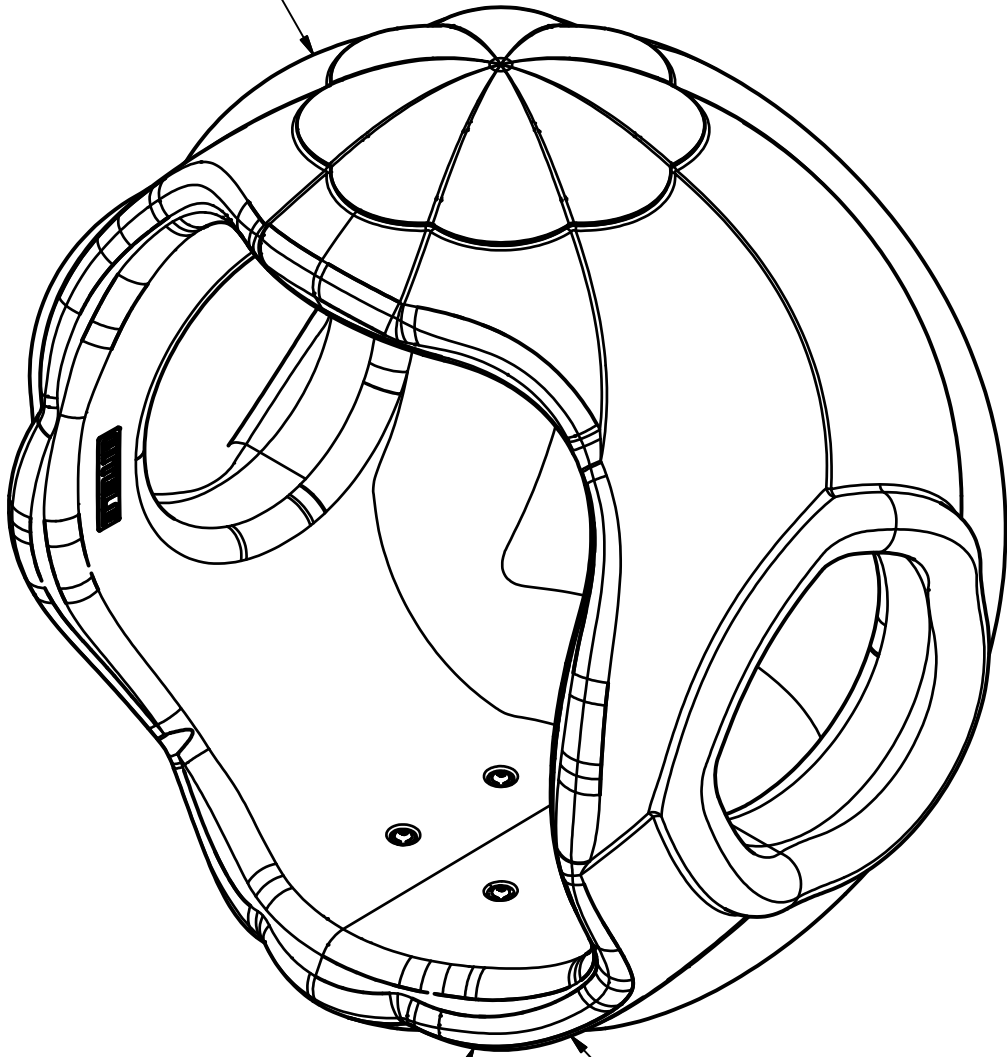

071
UNDERNEATH

INGROUND FOOTER
(02-07-0266)
UNDERNEATH

FINISHED ASSEMBLY

 = INSTALLATION DETAIL

Issued/Revised: 6/22/2020

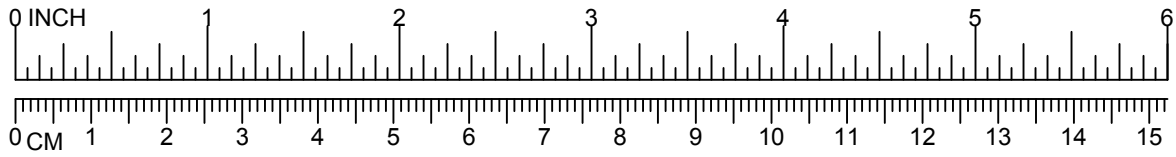

COZY POD SPINNER

