

SPECTRA CLEAN SERIES MODEL - WILDCAT G 3.5

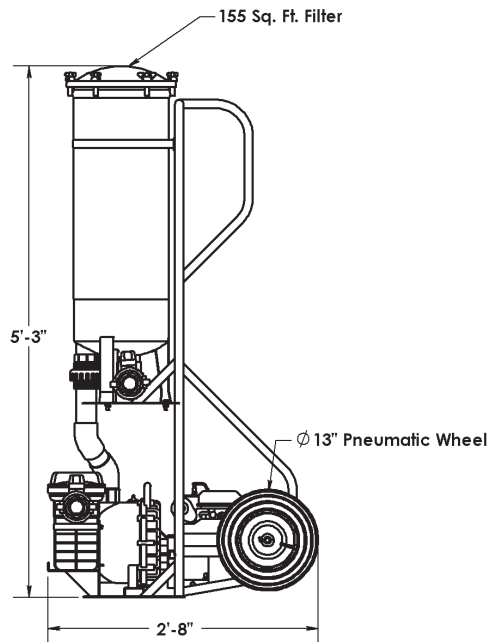
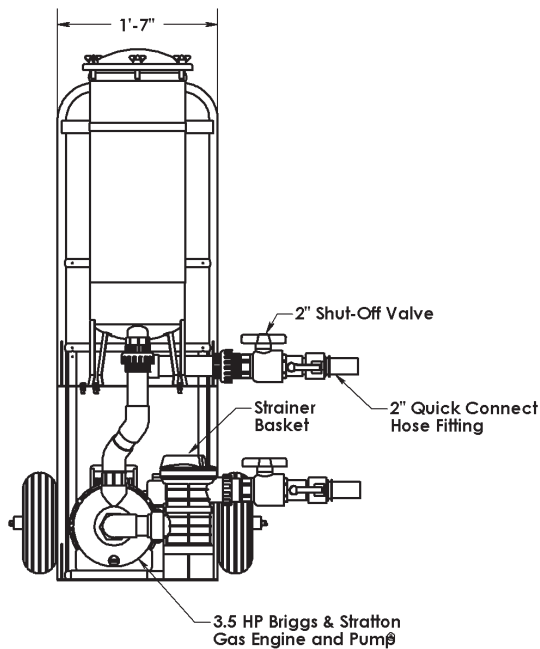
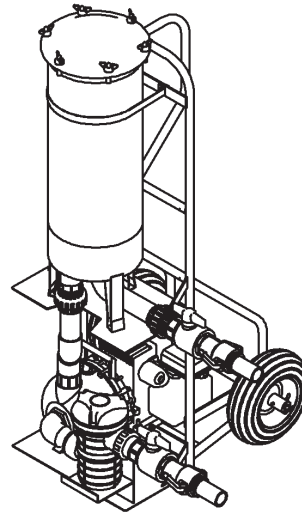
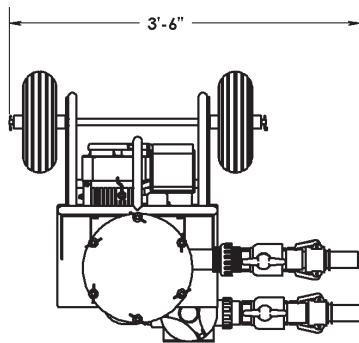

- APPROVED
- REVISE AND RESUBMIT
- APPROVED AS CORRECTED
- REJECTED
- SUBMIT SPECIFIED ITEM

Approval is only for conformance with the design concept of the Project and compliance with the information given in the Contract Documents. Contractor is responsible for dimensions to be confirmed and correlated at the job site for information that pertains solely to the fabrication process or to techniques of construction, and for coordination of the work of all trades.

Signature _____ Date _____

**Note: Drawings not to scale. Specifications are nominal and are subject to change.*



7100 Spectrum Lane
Missoula, Montana 59808
406.542.9781 • 800.791.8056
Fax: 406.542.1158
www.spectrumproducts.com

ENGINEERING DATA

Product:	Wildcat G 3.5
Product #:	10640
Date:	11/2006
Data Sheet #:	SA 10640.1106