







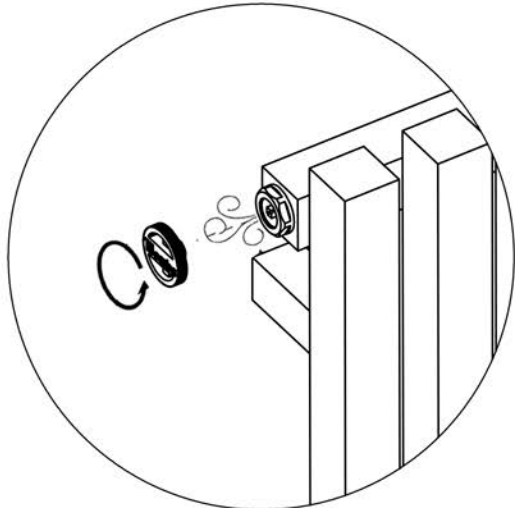

Key	Component	Qty
	A Bleeding Valve Key	1
	B Bleeding Valve 1/2 "	1
	C Blind Tap	1
	D Stud	4
	E Square Wall	4
	F Grub Screw	4
	G Screw-5,5x45mm	4
	H Wall Plug	4



**Assembly Instructions**

- Fit bleeding valve (B) & blind tap (C).
- Use Carisa bleeding valve key (A) to turn bleeding valve on final installation(B).
- Accurately mark out bracket holes on wall using spirit level.
- Drill four 8mm hole for each brackets (E).
- Screw brackets (E) into wall plugs (H) with 5,5mm diameter x 45mm screws (G).
- Assemble the studs (D) into the holes which on back of the collector.
- Hang radiator by centering the studs (D) into the brackets (E).
- Secure the stud (D) with the grub screw (F) after setting wall distance.