

Velino Series

Wall Hung Pan Installation Instruction

TISSINO

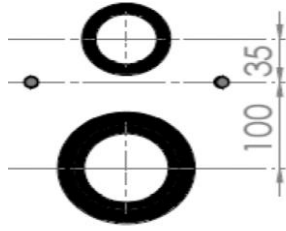

WARNING :

- * THE DISTANCE BETWEEN THE INSTALLATION HOLES SHOULD BE 180mm.
- * THE DISTANCE BETWEEN CENTER OF THE INSTALLATION HOLES AND CENTER OF THE WATER INLET HOLE MUST BE 35 mm.
- * THE DISTANCE BETWEEN CENTER OF THE INSTALLATION HOLES AND CENTER OF THE WATER OUTLET HOLE MUST BE 100 mm.

Parts 1 and 2 are mounted on the product at the factory.

1

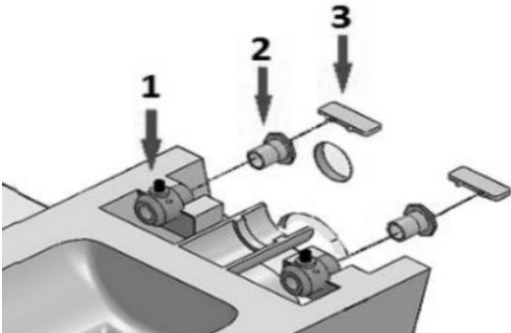

Tighten parts no:1 and no:2 that are placed in the installation holes by using the wrench no: 3.

2

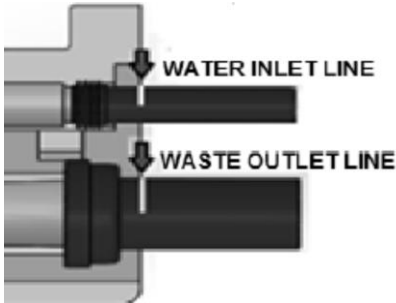

Place water inlet and drain outlet pipes on the corresponding holes on the toilet body. Mark the pipes on the point where they meet the toilet body.

3

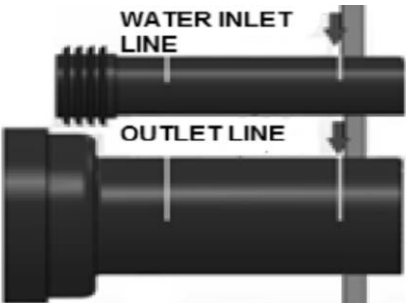

Water inlet and drain outlet pipes are placed into the installation holes on the wall. Mark the points on the both pipes where they meet the wall.

T 0345 582 8000
E info@tissino.co.uk
W tissino.co.uk

Lyncastle Road
Appleton Thorn
Warrington WA4 4SN

Velino Series

Wall Hung Pan Installation Instruction

TISSINO

4

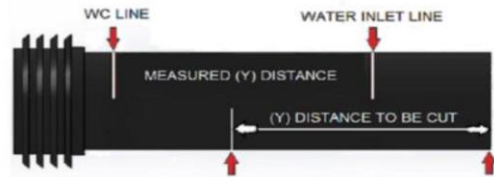

Measure the distance between two marks on water inlet pipe (y) and cut this length from the end of the pipe as shown in the picture. Therefore prepare the pipe for installation

5

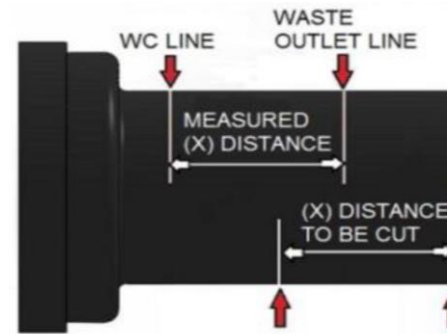

Measure the distance between two marks on the drain pipe (X) and cut this length from the end of the pipe as shown in the picture. Therefore prepare the pipe for installation

6

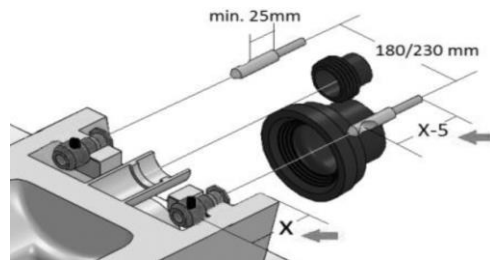

Measure the distance on the WC pan which is marked as (X) in the picture. Adjust the mounting screw so that the center of the head piece is 5 mm. less than the measured distance (X-5).

7

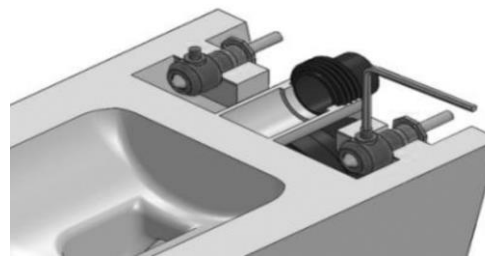

Put the toilet in its place as shown above. Place the allen wrench at the hole. Finalize the installation by tightening the screws on the pivot bolt.

T 0345 582 8000
E info@tissino.co.uk
W tissino.co.uk

Lyncastle Road
Appleton Thorn
Warrington WA4 4SN