

12、 bath-massage

- (1) Press the water switch, turn the select shift, pour " water ".
- (2) Water level should be 10-20mm higher than the sprayer.
- (3) Pouring enough water, press " atmosphere ", the engine works, and begins to spouting. During massage, turn on the " air conditioning ".
- (4) Press the " atmosphere ", when stop.
- (5) After showering, turn on the " draining switch " to drain water.

13、 sole-massage

Set the sole-massage to a suitable place, and turn the select shift to sole-massage, then press the water switch. Test the water temperature and begin massage. Press the water switch again and stop.

14、 turn off the tap

After using, turn the select shift to the original place. Press the water switch. at last power off.

ATTENTION

1. Please install and operate this product according to this manual.
2. Please fix reliable earth line and electric leakage protection device.
3. Please install general switch for power supply and water supply.
4. People with hypertension or drunk are not allowed to have sauna steam bath.
5. Children should have sauna steam bath under adult's instruction.
6. Please don't pour corrosive liquid into this sauna steam room.
8. Pay attention to the steam sprayer and water tank drainage, they are in high temperature while working.
9. please be ware of the step and never put finger into the door gap in case of accident.
10. Never knock the room with hard and heavy materials, in case of damage.
11. never smoke in the room in case of fire.
12. clean up the room after finish taking shower, in case of slippery surface.
13. when there is plastic strip is worn-out, please replace it as soon as possible in case of water leaking.
14. clean the bottom bathtub with toothpaste if there is some dirt.
15. please keep the bottom clean, in case of some waste stuck into the drainage.
16. never hang heavy things up the handle.
17. We don't take the responsibility for those damage caused by illegal operations.
18. Please dispose of this product according to native law when it is out of use.
19. Please contact our dealer for help if you have any problems.



Do not dispose this product as unsorted municipal waste. Collection of such waste separately for special treatment is necessary.



Install manual Steam bathroom

MODEL : WS-608P



INSTALL GUIDE

1. Check if all the parts complete.
2. Set all the parts to right places, and make balance.
3. Set the parts according to the diagram.
4. After step 3, power on and test.

THE TECHNIQUE PARAMETER OF THE PRODUCTS

1. Voltage: AC220V-240V 50Hz/60Hz
2. Water Volatge: 0.1~0.2Mpa
3. Power of steam generator: 3000W
4. Power og water pump: 1HP
5. SIZE: 1600x1600x2250 mm

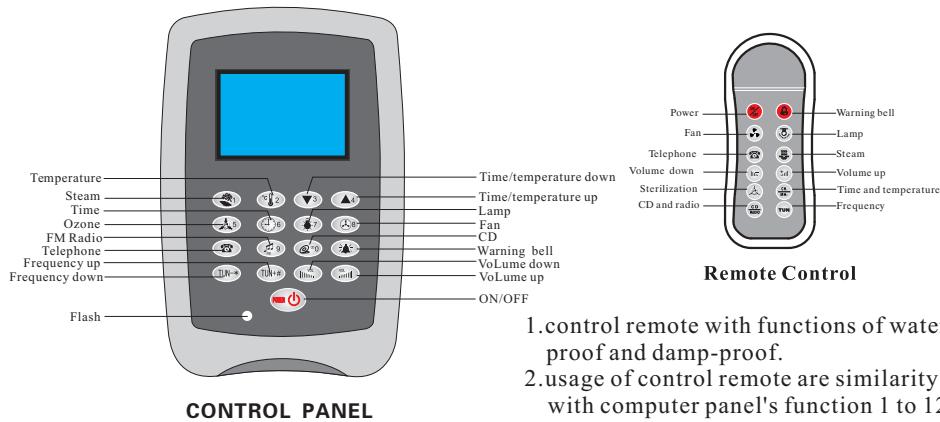

Remote Control



1. control remote with functions of water-proof and damp-proof.
 2. usage of control remote are similarity with computer panel's function 1 to 12.
 3. the effect of usage distance will be 5 meter.
- at throw it heavily/don, Please put the remote control c. s. refully

OPERATION METHOD







1、 power on

Connect to the power, press , and the top lamp is on. The screen shows all the patterns in 2 seconds and begin to test. Resume in 3-6 seconds.



2、 lamp

Press , the top lamp and wall lamp turn on. The screen shows a lamp pattern. If you want to turn it off, press  again.

3、 steam



- (1) Press  then press , the screen shows a steam pattern and begin to work, and water pour into the system. After about 1 minute, steam comes out. If running short of water, it will supply automatically.
- (2) Time and temperature selection: Press ,  to select the time or temperature function. Then press ,  to set the time or temperature. The time arrange is 5-60minutes . The arrange of temperature is 30-60°C.

4、 ozone disinfection





Press , and begin to disinfect. Press  again and stop. If disinfecting for 10min, it will stop automatically.

Note: the ozone sterilization can not use at the same time.







5、 fan

Press , the fan begin to work. The screen shows a fan pattern, if you want to stop, press  again.





6、 telephone

- (1) Make a telephone call: Press , the screen shows a telephone pattern, then dial. After getting through, speak towards the mic. Press ,  to set the volume.
- (2) when the bell ringing, press .
- (3) After dialing, press .

7、 radio

Press , choose the radio function. The screen shows a radio pattern, and the voice comes out from the loudspeaker, press  or  to set the frequency. Press ,  to set the volume. Press  again and turn off.

8、 CD

- (1) Press , the music comes out. The screen shows a "CD" pattern. Press ,  to set the volume. Press  again and stop.
- (2) you should connect the CD player, if choosing this function.

9、 warning

Press , the warning voice comes out from the loudspeaker. press again and stop.

10、 power off

Press , the screen shuts off. The system drains for 3 minutes, and the screen shows 3 minutes count backwards. Finally, power off the main power source.

11、 taking shower and water-massage

Press the water switch, and pour water. Get a suitable temperature. According to your need, choose the shower function. The function of the select shift (from right to left) is movable shower bath, big acupuncture water-massage, small acupuncture water-massage, waterfall, and sole-massage shower bath, acupuncture water massage, roof shower bath, movable shower bath, turn the shift and select what you need.

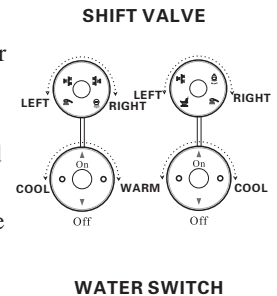

WATER SWITCH

CONSTRUCTION SKETCH

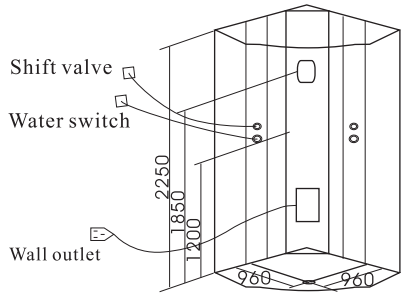
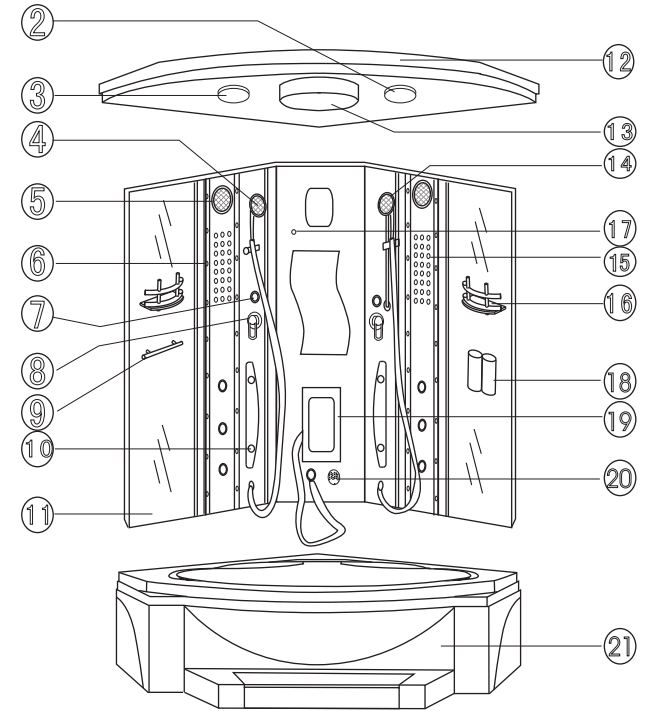
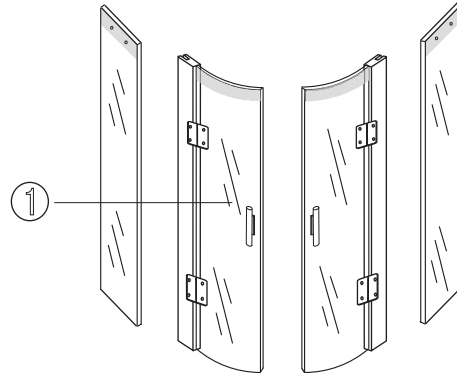

- 1、 glass door
- 2、 exhaust fan
- 3、 ozone
- 4、 moveable shower
- 5、 speaker
- 6、 decorated lamp
- 7、 water switch/mixer
- 8、 cold/hot water switch
- 9、 towel shelf
- 10、 nozzle
- 11、 body
- 12、 body roof
- 13、 roof lamp
- 14、 moveable shower
- 15、 decorated lamp
- 16、 handrail
- 17、 temperature sensor
- 18、 soap box
- 19、 foot massage
- 20、 berb box
- 21、 bottom bathtub
- 22、 control panel
- 23、 water switch/mixer
- 24、 nozzle

- 25、 waist -shaped board
- 26、 waist -shaped board

Electric circuit sketch

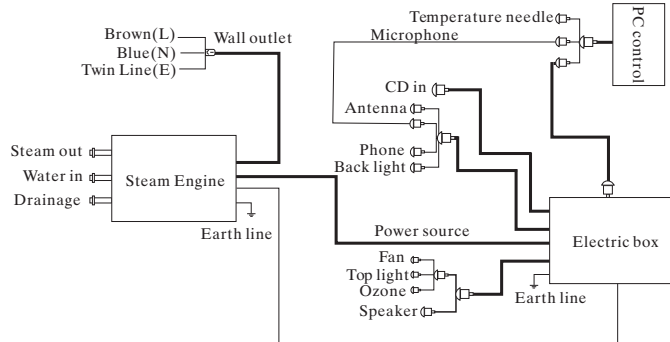

Please install the earth line safely by professional technician.

- 1、 waterfall
- 2、 drainage switch
- 3、 water pump switch
- 4、 air conditioning
- 5、 water in
- 6、 water jet
- 7、 drainage

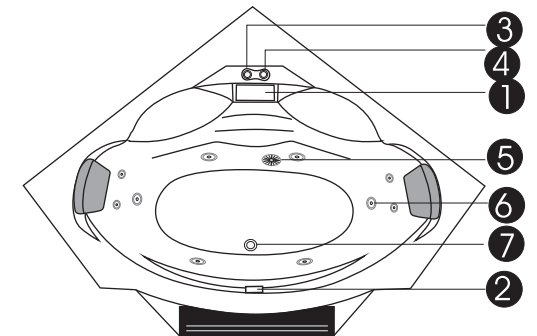

SIZE: 1600X1600X2250mm

Installation Diagram

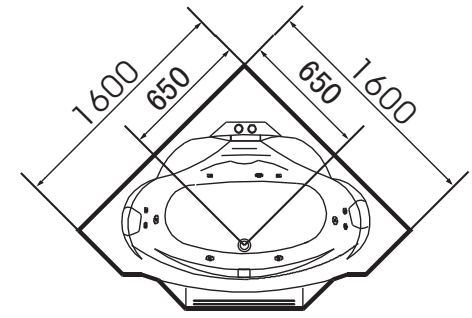
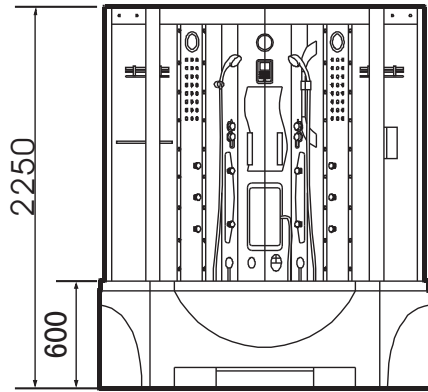

SIZE:1600X1600X2250mm

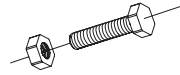

specification: M6 x 25



specification: SP4 x 25



specification: SP4 x 15

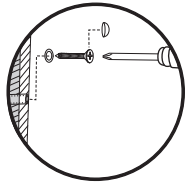

SP4 x 15

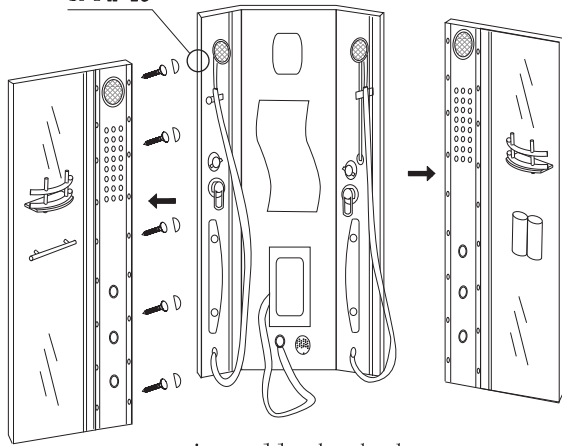

install the body

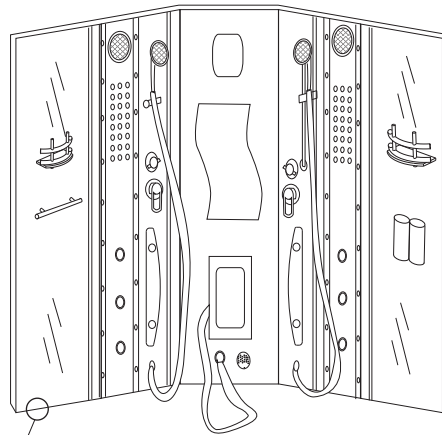

install the glass door onto the bottom

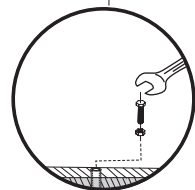

SP4 x 25

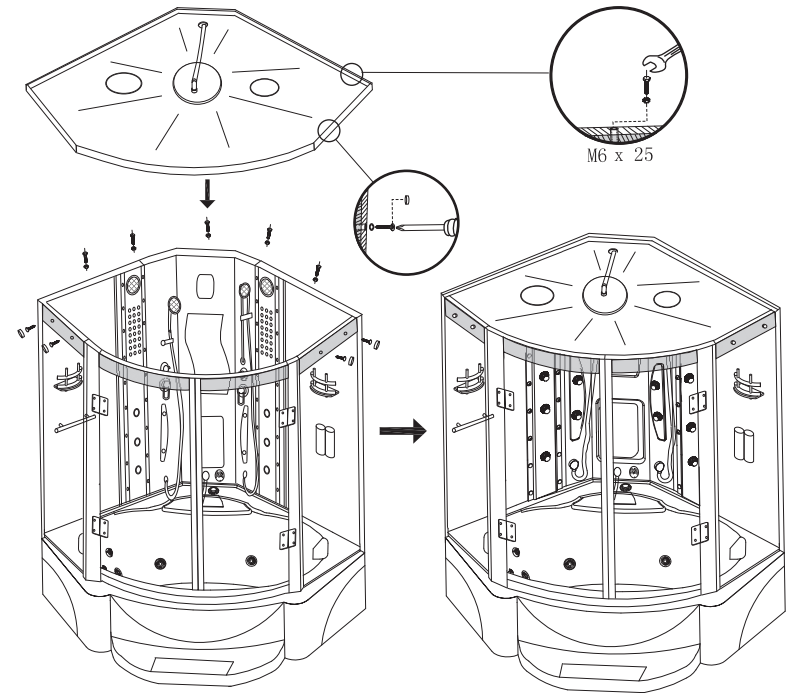

install the top

OK

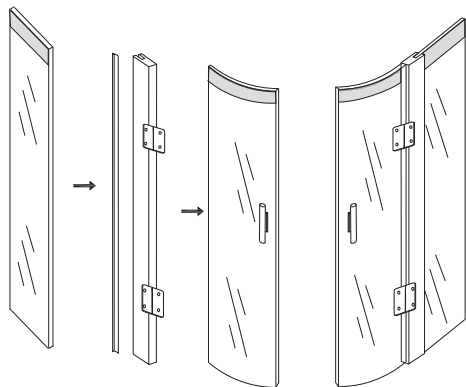

install the left/right glass door

1. When install the glass door onto the bottom tub or the roof, must first fix the plastic strip on the aluminum column of the glass door. If the length of the plastic strip is inappropriate, may voluntarily cut and press the plastic strip according to the aluminum column section shape, then locks the screw.

2. During the process of installation, it is necessary to stick with silicon glue for the moveable door, but other parts which the body of room connection should be use silicon glue in order to avoid water leaking and steam leaking.