



GDI-7289-01 / GDI-7289-01L / GDI-7689-01 / GDI-7689-01L

2-3 and 4-6 Person Saunas



OWNER'S MANUAL

FOR STEAM MODEL SAUNAS

240VAC 40 AMP DEDICATED CIRCUIT PLUS 120VAC 15 AMP CIRCUIT

Please Note: Model numbers with "L" indicate stone on the rear wall panel and step-down lighted ceiling. Model designs are subject to change. Steam heater must be installed by a certified electrician.

Thank you for the purchase of your new Steam Sauna!

FOLLOW ALL INSTRUCTIONS AND BE CAUTIOUS OF SAFETY SYMBOLS



High Voltage Symbol: Be cautious as there is the presence of a high voltage current that flows through the equipment!



General Caution Symbol: Be cautious as the equipment uses electrical current that can cause serious injury.

ATTENTION

⚠️ WARNING

1. Please read this Operating Instruction Manual thoroughly before use. This will allow the user to become familiar with the operation of the control system. Please keep the Operating Instruction Manual available for future reference. If any technical assistance or repairing is needed, please contact the manufacturer.
2. The steam sauna must be installed indoors or can be installed outdoors within the protection of a structure that includes a water-proof roof protecting it from the outdoor weather elements. When not in use and placed outdoors, a water proof cover **must** be used to cover the sauna room.
3. To reduce the risk of electric shock and/or fire, do not expose the control system to direct water contact or rain. Do not open the cover to the control system as there are high tension fittings that can be dangerous. Only dealer authorized qualified technicians should make any needed or necessary repairs at any time.
4. Any repairs, alterations, or modifications to the control system are not authorized unless by an approved repair technician. Any non-authorized repairs, alterations, or modifications can lead to serious injuries and can cause the unit to work outside its intended specifications parameters.
5. Any non-authorized repairs, alterations, or modifications will void the warranty.
6. Before connecting the unit to a power source, please make sure that all wires, cords, and connections are connected properly.
7. Make sure that the control system is in a well-ventilated and dry area. Do not place it next to any heat source, in direct sunlight, where there is any type of vibration, or in any damp or dusty environment. It should not be placed in an area with other thermal-radiating objects.
8. When the equipment is not going to be used for an extended period of time, unplug the unit from the power source.
9. Allow 30 seconds between turning the control system “On” and “Off”. By allowing 30 seconds between powering the control system “On” and “Off” will prolong the life of the unit.
10. Confirm that you adhere to the correct power requirements of the control system. Connecting the control system to other than the required voltage can damage the control system and possibly cause serious injury. It is very important that the load parameters are consistent with that needed by the control system.
11. Canadian Red Cedar and its rich aroma can cause an extremely small percentage of the population to have an adverse reaction known as Multiple Chemical Sensitivity (MCS). While this is not an universally recognized disorder in the medical field, certain consumers have an adverse physical reaction to low levels of many common chemicals and cannot tolerate any aromatic oils, shampoos with perfumes infused or certain herbs with natural aromas. However, for the majority of the population, Canadian Red Cedar is the sauna wood of choice.

CAUTION: Exit sauna immediately if you feel dizzy, sleepy, or any discomfort.

READ ALL INSTRUCTIONS THOURGHLY BEFORE ASSEMBLY

GDI-7289-01L

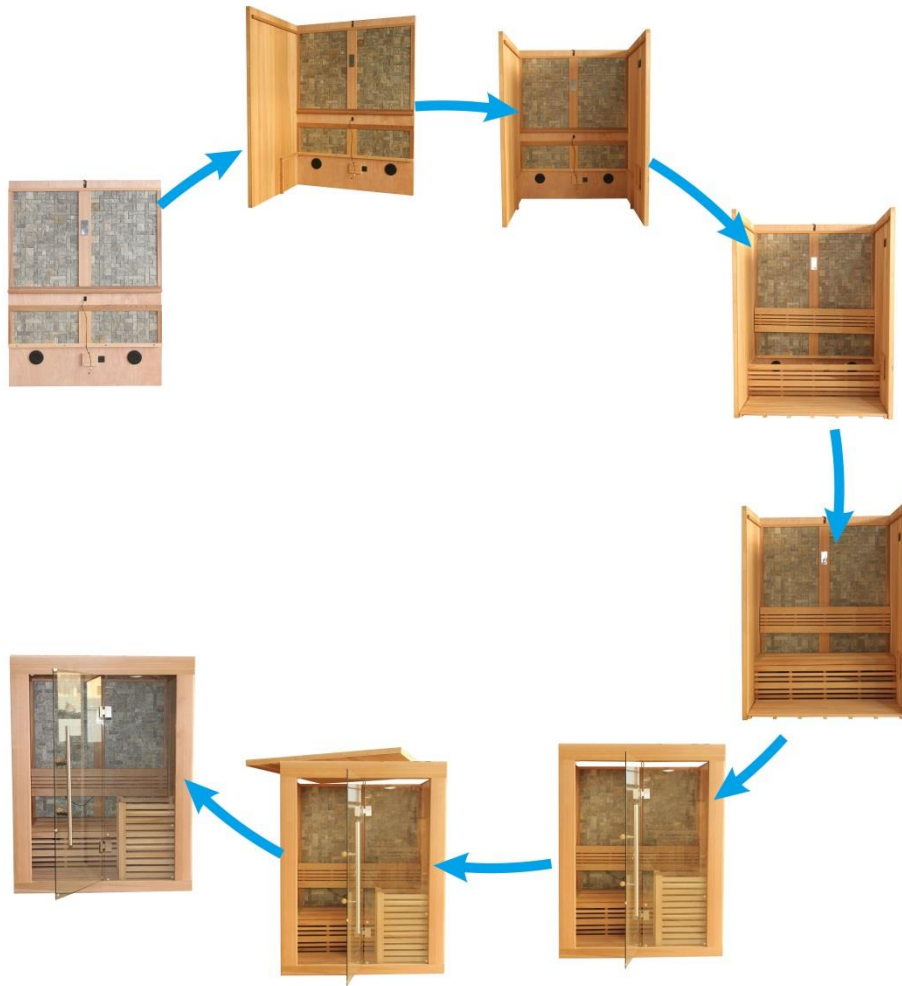

***The above assembly diagram is for a quick reference visual guide only. All sauna models are not shown. The wooden box for the steam stove has been removed from models with limited space. Parts and accessories may vary and not always be included.**

GDI-7289-01L Schematics

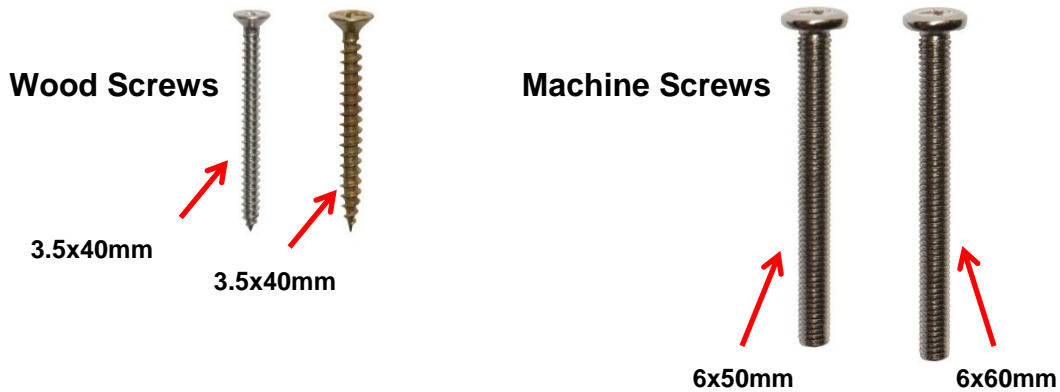
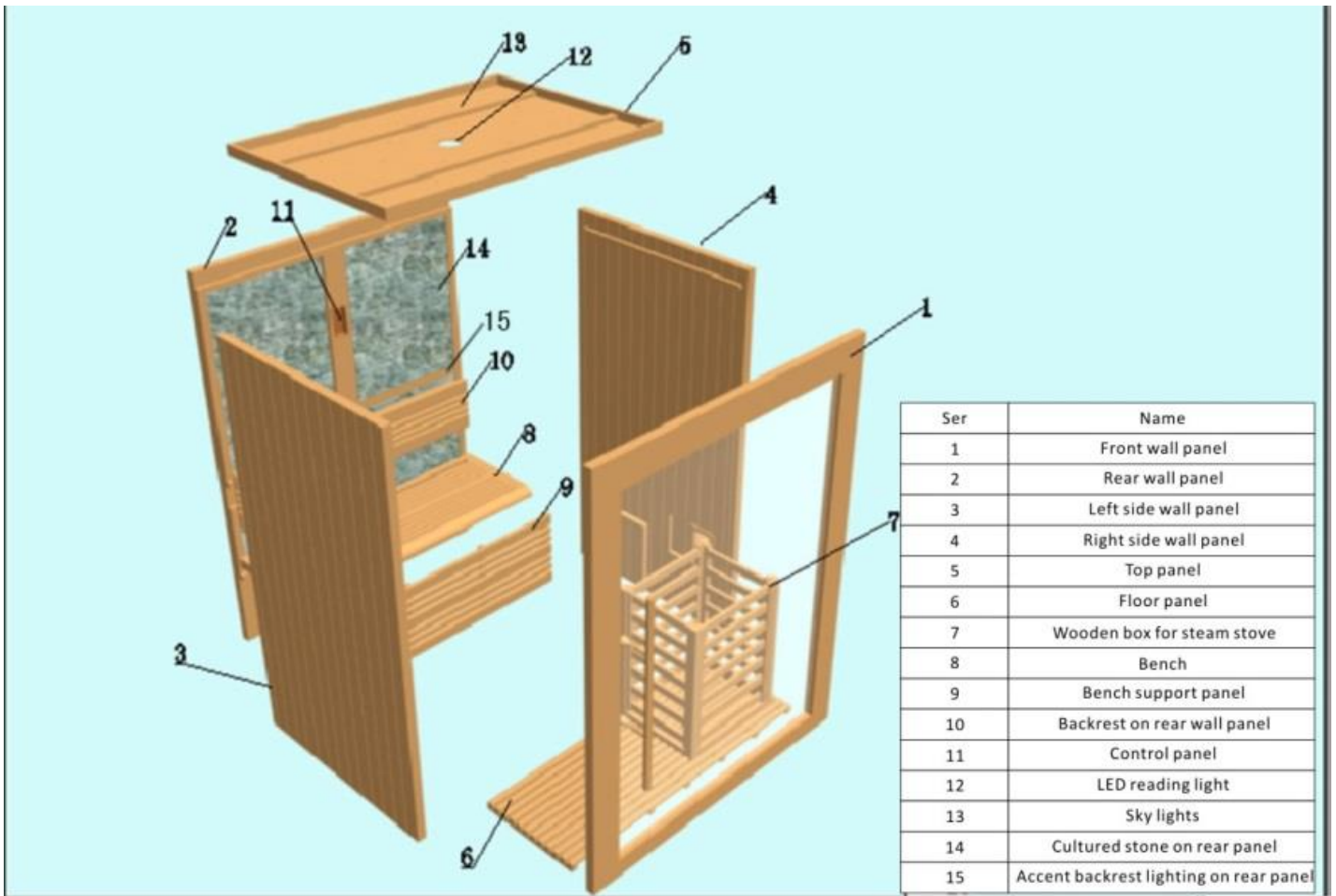

***The above assembly diagram is for a quick reference visual guide only. All sauna models are not shown. The wooden box for the steam stove has been removed from models with limited space. Parts and accessories may vary and not always be included.**

CAUTION: Exit sauna immediately if you feel dizzy, sleepy, or any discomfort.

READ ALL INSTRUCTIONS THOURGHLY BEFORE ASSEMBLY

GDI-7689-01L

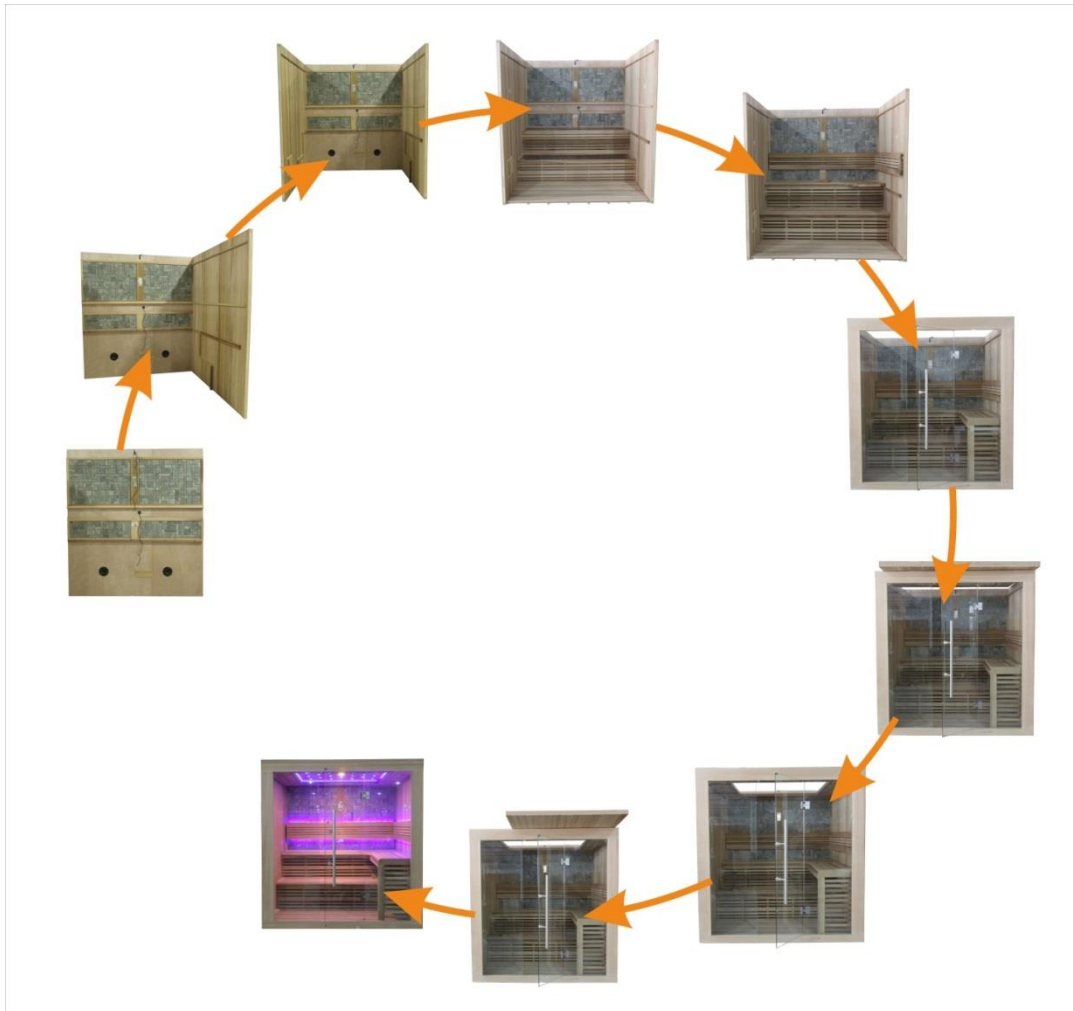

***The above assembly diagram is for a quick reference visual guide only. All sauna models are not shown. Parts and accessories may vary.**

GDI-7689-01L Schematics

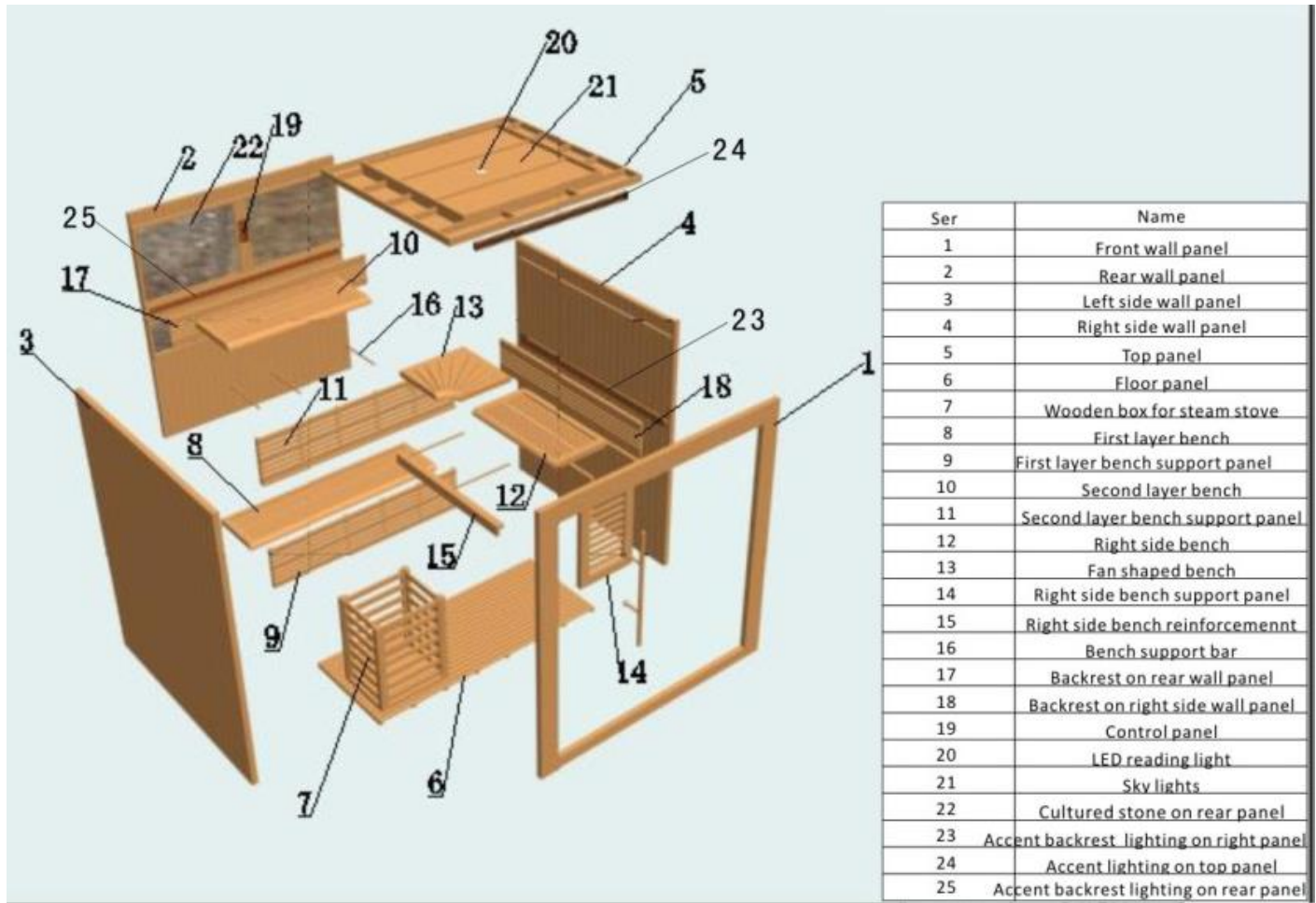

*The above assembly diagram is for a quick reference visual guide only. All sauna models are not shown. Parts and accessories may vary.

TABLE OF CONTENTS

Product Introduction	7
Parts Description	8
Assembly Instructions	9
Control Panel Operation	26
Tips for Using Your Sauna	28
Safety Instructions	28
Safeguards for Your Sauna	30
Warranty	31
Warranty Card	33

WARNING: Visually inspect all parts before assembly to make sure they are not damaged. Any excessive vibrations during transport could cause damage to the sauna components. DO NOT START the sauna if damage is detected! Contact your dealer or manufacturer for troubleshooting and replacement parts.

1. Product Introduction

The steam sauna room is composed of a wood cabin. The wood cabin includes a FRONT WALL PANEL with GLASS, REAR WALL PANEL, LEFT SIDE WALL PANEL, RIGHT SIDE WALL PANEL, ROOF, and BENCHES. Other smaller wood items will also be included and can be identified in the schematics on page 4.

SCREW IDENTIFICATION AND LOCATION CHART:

MODELS: GDI-7289-01 & GDI-7289-01L

LOCATION	SPECS	USAGE
Bench Heater Panel, Bench Support, & Backrest	3.5x40mm (wood screw - silver color) =	5
Bench	5x40mm (wood screw - gold color) =	2
Roof Panel	3.5x40mm (wood screw - gold color) =	10
Front Wall Panel	6x50mm (machine screw) =	8
Rear Wall Panel	6x60mm (machine screw) =	8

MODEL: GDI-7689-01

LOCATION	SPECS	USAGE
Bench Heater Panel, Bench Support, & Backrest	3.5x40mm (wood screw - silver color) =	12
Bench	5x40mm (wood screw - gold color) =	8
Stove Frame & Roof panel	3.5x40mm (wood screw - gold color) =	22
Front Wall Panel	6x50mm (machine screw) =	8
Rear Wall Panel	6x60mm (machine screw) =	8

MODEL: GDI-7689-01L

LOCATION	SPECS	USAGE
Bench Heater Panel, Bench Support, & Backrest	3.5x40mm (wood screw - silver color) =	12
Bench	5x40mm (wood screw - gold color) =	8
Stove Frame & Roof panel	3.5x40mm (wood screw - gold color) =	32
Front Wall Panel	6x50mm (machine screw) =	8
Rear Wall Panel	5x50mm (machine screw) =	2
Rear Wall Panel	6x60mm (machine screw) =	8

NOTE: The pictures and diagrams shown within this owner's manual are representations of this model. Actual model may vary. Design and Construction are subject to change.

2. Parts Description

- A. The REAR WALL PANEL can be seen in the image below. It will have speakers towards the bottom of the interior side of the wall panel. It will have some cord connection at the top center. (see Figure 1)



Figure 1

- B. The SIDE WALL PANELS are the same size. The LEFT SIDE WALL PANEL on models GDI-7689-01 and GDI-7689-01L will have a vent. The RIGHT SIDE WALL PANEL on models GDI-7289-01 and GDI-7289-01L will have a vent. (see Figure 2)



Figure 2

- C. The FRONT WALL PANEL can be seen in the image below. The FRONT WALL PANEL will have the two stationary glass panels already in place and the glass door will be pre-installed. (see Figure 3)



Figure 3

Assembly Instructions

A. Choose a good location to install the sauna

1. The location must be dry, leveled, and away from any source of water
2. MAIN POWER cord must be easily accessible
3. Two adults are required for installation on models GDI-7289-01/GDI-7289-01L and three adults for installation on models GDI-7689-01/GDI/7689-01L.
4. Wood cabin installation order: REAR WALL PANEL ► RIGHT SIDE WALL PANEL ► LEFT SIDE WALL PANEL ► SECOND LAYER BENCH SUPPORT PANEL ► FIRST LAYER BENCH SUPPORT PANEL ► FLOOR PANEL ► SECOND LAYER BENCH ► FAN SHAPED BENCH ► FIRST LAYER BENCH ► BACKREST ON REAR WALL PANEL ► BACKREST ON RIGHT SIDE WALL PANEL ► RIGHT SIDE BENCH SUPPORT PANEL ► RIGHT SIDE BENCH REINFORCEMENT ► RIGHT SIDE BENCH ► FRONT WALL PANEL ► ROOF PANEL
5. Tools Required: Battery Operated Screwdriver or Hand-Held Philips Screwdriver and Ladder

B. Installing the REAR WALL PANEL and RIGHT SIDE WALL PANEL

1. **For model GDI-7689-01L, please continue to follow these instructions. For all other models, please proceed to 1a.** Place the REAR WALL PANEL and RIGHT SIDE WALL PANEL upright and next to each other. The small wood block on the RIGHT SIDE WALL PANEL will need to fit into place on the interior side of the REAR WALL PANEL. First, screw in the exterior top and bottom 6x60mm machine screws only. Next, align the interior wood block to the REAR WALL PANEL and use the two 5x50mm wood screws to mount the REAR WALL PANEL to the RIGHT SIDE WALL PANEL. Finally, use (on the exterior side) the remaining two 6x60mm machine screws to mount the REAR WALL PANEL to the RIGHT SIDE WALL PANEL. (see Figure 4a and Figure 5)
- 1a. **For models GDI-7289-01, GDI-7289-01L and GDI-7689-01, please continue to follow these instructions.** Place the REAR WALL PANEL upright. Next, stand the RIGHT SIDE WALL PANEL upright and up against the REAR WALL PANEL. Locate the screw holes on the exterior side and screw the two wall panels together using the 6x60mm screws.(see Figure 4 and Figure 5)

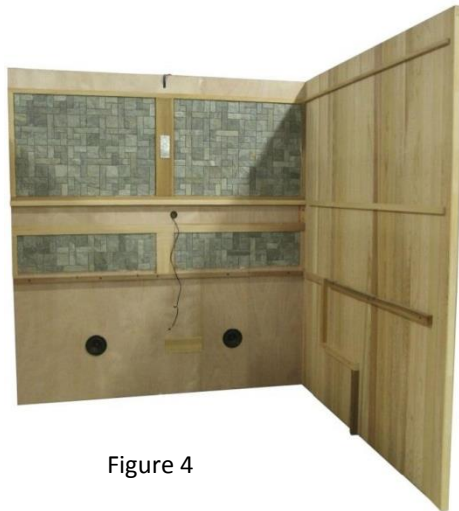

Figure 4



Figure 4a

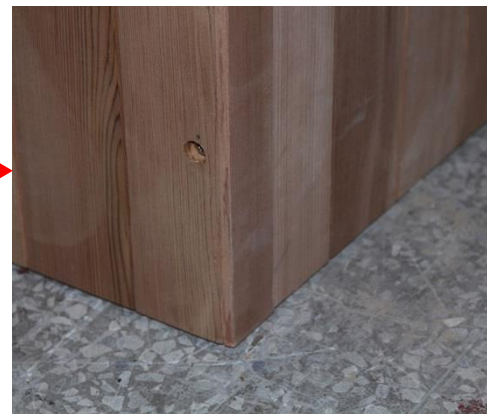
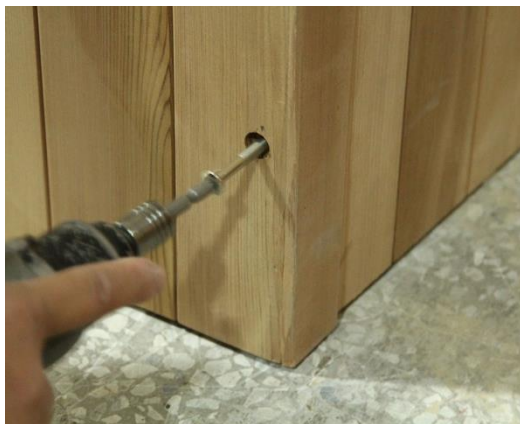

Figure 5

C. Installing the LEFT SIDE WALL PANEL to the REAR WALL PANEL

1. Place the LEFT SIDE WALL PANEL up against the REAR WALL PANEL and follow the same instructions used to mount the RIGHT SIDE WALL PANEL to the REAR WALL PANEL. Make sure to use the correct size wood screws when screwing the wall panels together. (see Figure 6 & 7)



Figure 6



Figure 7

D. Installing the FLOOR HEATER and FRONT WALL PANEL to the LEFT SIDE WALL PANEL and RIGHT SIDE WALL PANEL

1. First, place the FLOOR HEATER on the inside of the sauna room and on your floor (concrete floor is preferred). Three adults will be need to install the front wall panel. Be cautious when installing the FRONT WALL PANEL with the stationary glass panels and glass door. Stand the FRONT WALL PANEL up against the side wall panels and use the 6x50mm machine screws to Attach the FRONT WALL PANEL. (see Figure 8)

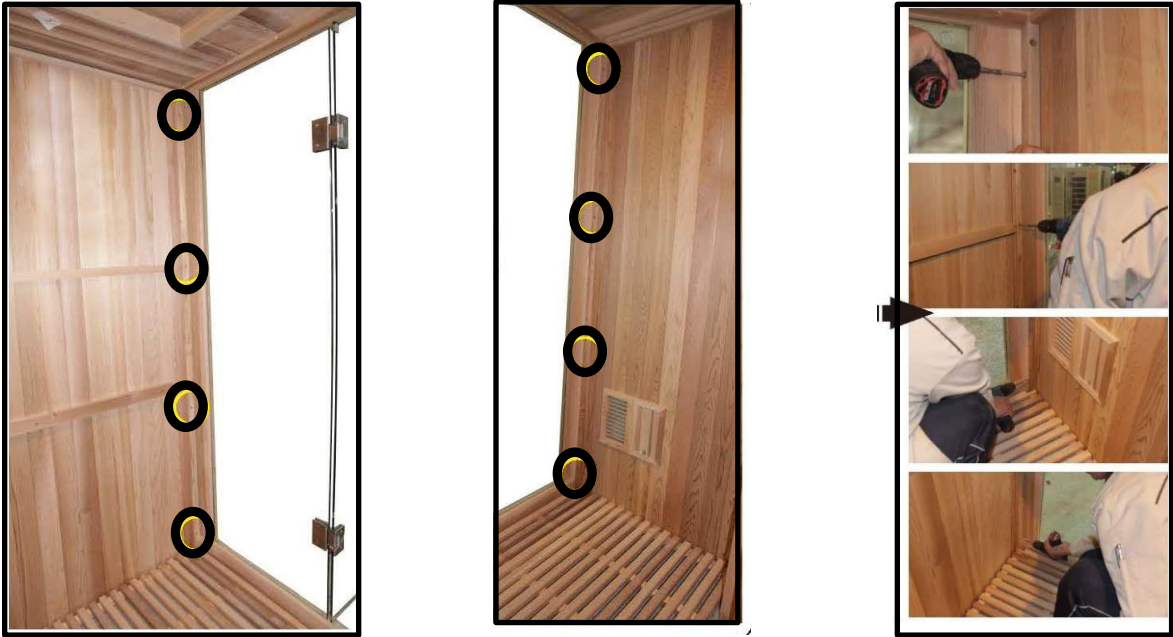

Figure 8

E. Installing the SECOND LAYER BENCH SUPPORT PANEL, FIRST LAYER BENCH SUPPORT PANEL, and FLOOR PANEL

1. Hold the SECOND LAYER BENCH SUPPORT PANEL vertically in place and install it as seen in Figure 9 below. The SECOND LAYER BENCH SUPPORT PANEL is only on models GDI-7689-01 and GDI-7689-01L.
2. Next, hold the FIRST LAYER BENCH SUPPORT PANEL vertically in place and install it as seen in Figure 9 below. Also, place FLOOR PANEL in position as well. Use the 3.5x40mm screws to secure the BENCH SUPPORT PANELS into place. (see Figure 10)



Figure 9



For Model GDI-7689-01 and GDI-7689-01L

Figure 10



For Model GDI-7289-01 and GDI-7289-01L

F. Installing the SECOND LAYER BENCH and FIRST LAYER BENCH

1. Slide into position the narrow wood slats that support the SECOND LAYER BENCH (upper bench for models GDI-7689-01 and GDI-7689-01L). (see Figure 11)
2. Next, slide into position the SECOND LAYER BENCH (upper bench for models GDI-7689-01 and GDI-7689-01L)). The screw locations are indicated with arrows for the upper and lower benches. (see Figure 12 & Figure 12a)(Please Note: **ONLY INSTALL BENCH ALONG REAR WALL AT THIS TIME**)
3. Then slide into position the FIRST LAYER BENCH (lower). (see Figure 13)



Figure 11

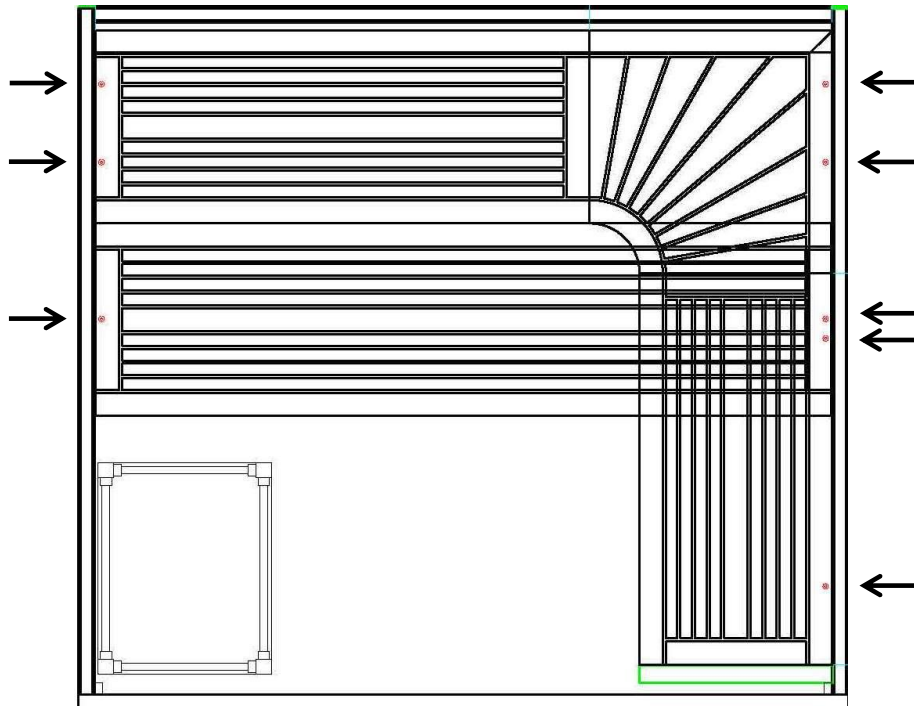

Figure 12



Figure 12a

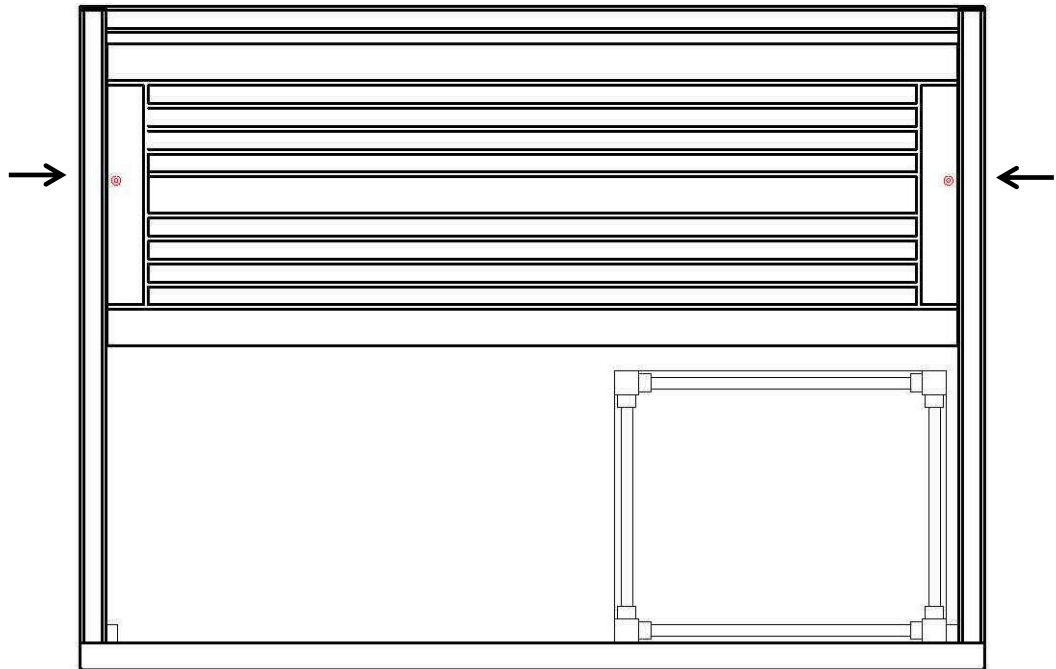

Figure 13



Figure 13a

G. Installing the BACKREST ON WALL PANELS

1. Now it is time to install the BACKREST ON REAR WALL PANEL. In addition, you will need to connect the wire connection from the REAR WALL PANEL to the wire connection on the BACKREST ON REAR WALL PANEL (only on models GDI-7289-01L and GDI-7689-01L). After connected, tuck the wires behind the BACKREST. Use the 3.5x40mm screws to screw into place (see Figure 14 and Figure 15)



Figure 14

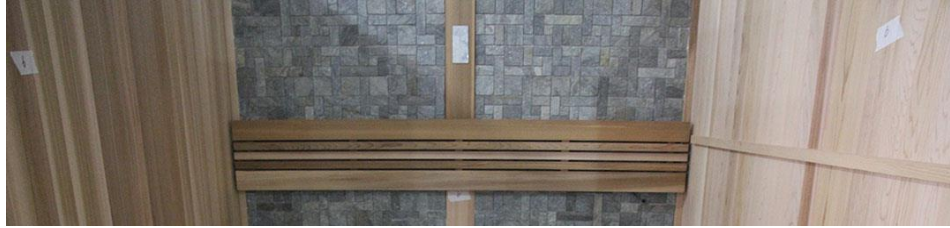

Figure 15

2. It is time to install the BACKREST ON RIGHT SIDE WALL PANEL. You will need to connect the wire connections from the SIDE WALL PANEL to the wire connection on the BACKREST ON THE SIDE WALL (only on model GDI-7689-01L). After connected, tuck the wires behind the BACKREST. Use the 3.5x40mm screws to screw into place (see Figure 16, 17, and 18) **(Please note that the FAN SHAPED BENCH has not yet been installed as seen in figure 16. It will be installed in Section H, Part 2.)**



Figure 16



Figure 17



Figure 18

H. Installing the FAN SHAPED BENCH, RIGHT SIDE BENCH SUPPORT PANEL, RIGHT SIDE BENCH REINFORCEMENT, and RIGHT SIDE BENCH (only on models GDI-7689-01 and GDI-7689-01L)

1. You are ready to install the FAN SHAPED BENCH, RIGHT SIDE BENCH SUPPORT PANEL, and RIGHT SIDE BENCH REINFORCEMENT. Be sure to slide into position the narrow wood slats that support the RIGHT SIDE BENCH as seen in Figure 21. Use the 3.5x40mm screws to secure. Please see Figures 19, 20, and 21 below.

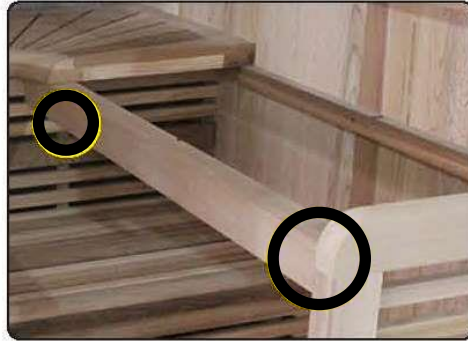

Figure 19



Figure 20



Figure 21

2. The RIGHT SIDE BENCH and FAN SHAPED BENCH are ready to be installed. (see Figure 22, Figure 23, and Figure 24)



Figure 22

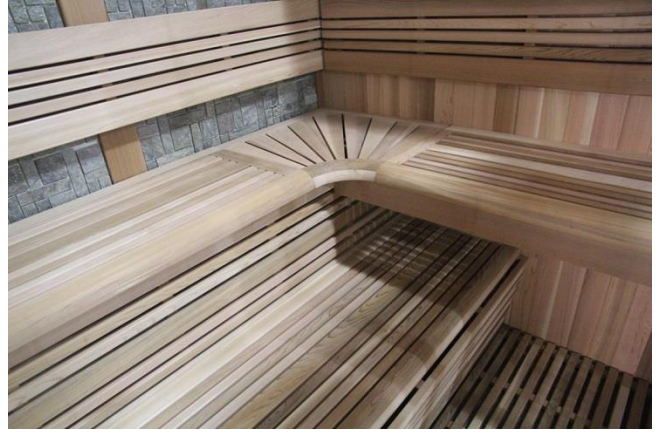

Figure 23



Figure 24

J. Installing the ROOF PANEL

1. Place the ROOF PANEL (larger section) over the wall panels carefully. (see Figure 25)
2. Next, place the ROOF PANEL (smaller section) on top of the ROOF PANEL (larger section) and slide into place. (see Figure 26)
3. Use the 3.5x40mm screws to secure the roof into place. (see Figure 27)



Figure 25



Figure 26

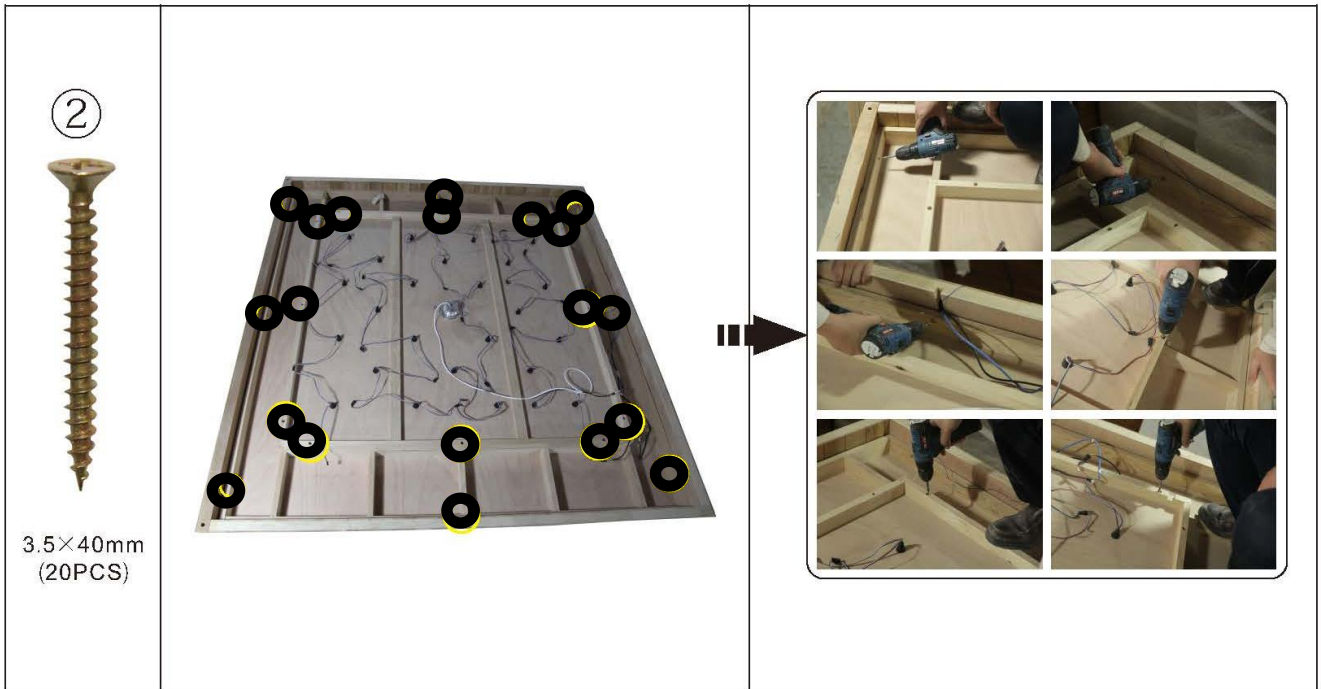

Figure 21



Please Note: Model numbers with “L” indicate stone on the rear wall panel and step-down ceiling. Model designs are subject to change. Steam heater must be installed by a certified electrician.

J. Assembling the Wooden Box for the Steam Stove (not available on all models)

1. Use the provided 3.5 x 40mm screws to attached the (4) walls and base of the Wooden Box for the Steam Stove.
2. The opening on one of the larger sides is to allow you manage the controls of the Steam Stove. This would be considered the front of the Wooden Box.
3. Place the assembly Wooden Box on the interior of the sauna room in front of the wall vent.

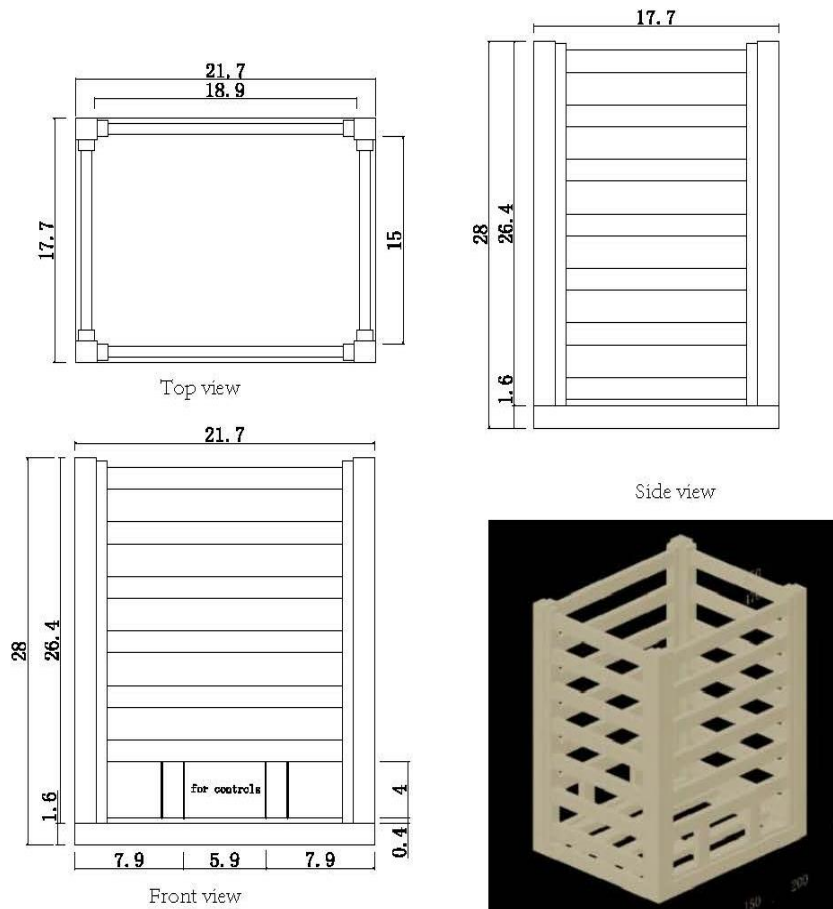

ASSEMBLY COMPLETED!

CONTROL PANEL GENERAL INTRODUCTION

1. Description of Functions

Functions	
Touch Key technology	√
FM Radio	√
Reading Lamp	√
Background Lamp and Star Lights	√
Bluetooth Music Play	√

2. Control System Specifications

- A.) Rated Voltage: AC100V-AC240V
- B.) Bluetooth Approximate Effective Distance: 33 feet
- C.) Rated Power: 50Hz/60Hz

3. LCD Screen displays the following information:

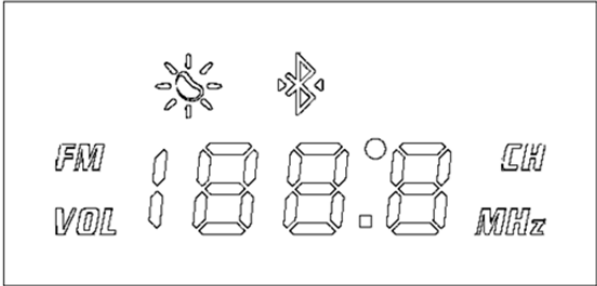

4. Devices controlled by the Control System are:

- A.) Reading Lamp
- B.) Background Lamp and Star Lights
- C.) Speaker System

5. Control Panel Display





CONTROL PANEL OPERATION

1. “ **Power** ”: Powers the unit “ON/OFF”.



A.) Press the “ **Power** ” to turn the Control Panel “ON”. The LED will display “  ”, which means the Control System has powered “ON”. In addition, the Reading Lamp should be “ON” as well. If you press the “ **Power** ” once again, the Control Panel will turn “OFF”.

B.) The Control System will remain “ON” for 45 minutes. After the 45 minutes has expired, the Control System will turn “OFF”.





2. “ **Light 1** ”: Powers the Reading Lamp “ON/OFF”.

A.) Press the “ **Light 1** ” to turn the Reading Lamp “ON”. The LED will show “  ”. Press the “ **Light 1** ” again to turn the Reading Lamp “OFF” and the “  ” will disappear.

3. “ **Light 2** ”: Powers the Background Lamp and Star Lights “ON/OFF”.

A.) Press the “ **Light 2** ” to turn on the Background Lamp and Star Lights. The LED will show “  ”. Press the “ **Light 2** ” again to turn the Background Lamp and Star Lights “OFF” and the “  ” will disappear.





4. “Media”: Powers on the Radio and operates the Bluetooth ().

A.) Press the “Media” to turn “ON” the FM function of the Radio. The LCD display will show the current frequency. When you press the “Media” again, you will turn on the Bluetooth function allowing you to connect your musical device. Once the Bluetooth is connected to your musical device, the “” and “” will stop flashing. If the “” and “” continue to flash, then your musical device has not connected to the Bluetooth.

B.) To exit from “Media”, press “Media” a third time.

C.) If you have exited from “Media”, you will need to press the “Media” to return to the FM function. The FM frequency range is 87.5MHz – 108.0MHz. You can select a FM radio station by pressing “>” and “<”. If you press either “>” or “<” for more than 2 seconds, the system will search for radio stations. You will see the selected radio station on the Control Panel display. If you scroll to the frequency range limit (say 108.0MHz), press the “>” again and it will continue to 87.5MHz.

D.) To set the radio station, press the “Set” until you see “VOL” flashing on the Control Panel display. While it is flashing, press the “>” and “<” to select the station you want memorized. Then press “Mem” and hold for 3 seconds to store it. Once stored, you can search the memory to find that stored station. When you are still in the FM function, press “Set” until the Control Panel displays “CH”. Then press “>” or “<” to select a stored station. To exit, press “Media”.

E.) To sink with Bluetooth, search the Bluetooth device name PROW-BT Bluetooth Cell Phone. You should be able to select the pairing on your device. Once the Bluetooth is connected to your musical device, the “” and “” will stop flashing. If the “” and “” continue to flash, then your musical device has not connected to the Bluetooth. To disconnect your device from the Bluetooth, turn off your device and press “Media” for 3 seconds.

F.) To pause the music while your musical device is playing, press “Media” for 3 seconds. Do the same to stop the pause and continue playing music. To play the previous song or next song, you can press “<” or “>”.

G.) The volume adjusting range is from -80dB to 0dB. To adjust the volume, press “ **Set** ” until “ **VOL** ” blinks on the Control Panel display. You can in press the “ **>** ” and “ **<** ” to adjust the volume setting. If you hold the “ **>** ” and “ **<** ” for more than 2 seconds, the volume will increase/decrease at a faster pace. After 5 seconds, the volume setting will be stored and the function will cancel itself.

Tips for using Your Sauna

- 1) If you take a hot/warm shower or bath before using your sauna, you may perspire more and experience more comfort.
- 2) Drink water prior to, during, and after your sauna session to replenish body fluids.
- 3) To regulate the set temperature inside the sauna to your comfort level, use the movable ventilation or leave the door open slightly. The ventilation is installed on the sauna and used based on personal preference.
- 4) Use 2 or 3 towels during your sauna session. Fold one of the towels several times and place it on the bench. This towel will absorb some of your perspiration while adding comfort as you sit on the bench. Place another towel on the floor to absorb perspiration as it falls from your body. Use a third towel to wipe perspiration from your body from time to time.
- 5) At the first sign of a cold or flu, increasing your sauna sessions may be beneficial in boosting your immune system and decreasing the reproductive rate of viruses.
- 6) To help relieve sore and tense muscles, massage the affected areas during your sauna session.
- 7) To treat your ankles and feet more effectively, you can elevate them and move them close to one of the heat emitters to achieve a deep heating effect.
- 8) The peaceful and relaxed state rendered by a sauna session may help you to sleep easier and deeper.
- 9) To protect the life of the stove, you can plug the unit into a GFCI outlet or unplug it when not in use.
- 10) After the sauna session is over, do not jump into the shower or bath immediately. Because your body was heated up during the sauna session, it will continue to perspire even after you exit the sauna room. Sit in the sauna with the door open slightly and let your body cool down. Once your body has cooled down and you feel comfortable, you can exit the sauna. After about twenty minutes and when your body has completely cooled down, you can take a shower to rinse the perspiration off your body.

Safety Instructions

- 1.) Read and follow all instructions carefully before using the sauna.
- 2.) When installing and using the electrical equipment, safety precautions should always be followed.
- 3.) To reduce the risk of injury, do not allow children to use the sauna unless they are directed by a

- medical doctor and are closely supervised at all times by an adult.
- 4.) Do not use the sauna immediately following strenuous exercises. Wait at least 30 minutes to allow the body to cool down completely.
 - 5.) Pregnant or possibly pregnant women should contact their physician prior to using the sauna. Excessive temperature has a high potential for causing fetal damage during pregnancy.
 - 6.) **Hyperthermia Danger:** the normal body temperature can't rise above 39°C (103°F). Symptoms of excessive hyperthermia include dizziness, lethargy, drowsiness, and fainting. The effects of excessive hyperthermia may include failure to perceive heat, physical inability to exit sauna, unawareness of impending hazard, unconsciousness and fetal damage in pregnant women. Hyperthermia could make your body's core temperature rise. Setting desired temperature to an excessively high temperature is not recommended.
 - 7.) The use of alcohol, drugs, or medications prior to or during the sauna session may lead to unconsciousness and/or other harmful physical injuries .
 - 8.) Persons suffering from obesity or with a medical history of heart disease, low or high blood pressure, circulatory system problems, or diabetes should consult a physician prior to using the sauna.
 - 9.) Persons using medications should consult a physician before using the sauna. Some medications may induce drowsiness while others may affect the heart rate, blood pressure, and/or blood circulation.
 - 10) Exercise care before and after sauna use.
 - 11) Never sleep inside the sauna.
 - 12) Do not use any type of cleaning agents on the interior of the sauna. Only wipe down with a cloth and water.
 - 13) Do not stack or store any object on top or inside the sauna.
 - 14) If the power supply cord becomes damaged, it must be replaced immediately by the manufacturer or its agent. If you find the power cord is too hot or that the electrical equipment may be experiencing technical problems, please contact the manufacturer or its agent immediately to avoid hazardous conditions.
 - 15) Do not use the sauna during an electrical storm to avoid risk of shock.
 - 16) Do not touch the glass door hinges during sauna use as they become very hot to the touch.
 - 17) Your hands must be dry and free of moisture before plugging and unplugging cords and wiring harnesses from the power supply and circuit boards. Never operate the sauna with wet hands or wet feet to avoid risk of electric shock. Never touch the metal prongs of the plug.
 - 18) Do not attempt to make any repairs yourself without contacting the manufacturer first. If a problem occurs with the sauna, please contact seller, distributor, or the manufacturer to avoid safety risks. Unauthorized repair attempts will void the manufacturer's warranty.
 - 19) Please make sure the outlet power supply meets the specifications required. Failure to meet the requirements may cause safety risks.
 - 20) Some sauna models are equipped with reading and roof lamps. Because the lamp temperature will become very hot once powered on, do not attempt to touch the lamp to avoid being burned. Do not attempt to touch it for at least 20 minutes after it has been powered off.

- 21) Do not bump, hit, or break the stove as it may cause an electrical short and pose a safety risk.
- 22) Do not make any modifications to the sauna, the sauna structure, or the sauna components.
- 23) Prior to each sauna session, the sauna room is to be inspected for correct operation. If for any reason your sauna room does not seem to be operating properly, discontinue use and contact the manufacturer.

Safeguards For Your Sauna

1. Do not install the sauna near water, near a bathtub, near a shower, in a wet basement, or near a swimming pool.
2. Do not use liquid cleaners or aerosol cleansers inside the sauna. Unplug the sauna from the wall outlet before cleaning. Use plain water and a soft cloth for cleaning.
3. The power supply cord should be routed so that it is not walked on or pinched by any object that may be placed against it.
4. When replacement parts are required, be sure they meet the specified requirements of the manufacturer.
Unauthorized substitutes may result in fire, electric shock, or other hazardous conditions. After any repairs, please ask the service technician to perform safety checks to determine that your sauna is working properly.
5. Do not use any wall receptacle adapter or extension cord between the sauna cord and wall receptacle.

Limited Lifetime Warranty

***Limited Lifetime Warranty:** Golden Designs, Inc. warrants the sauna room and its attached electronics against defects in material and workmanship for the life of the product from the original date of purchase. **This sauna is for indoor use or outdoor use when protected from the outdoor weather elements by a structure that includes a water-proof roof. When not in use and placed outdoors, a water proof cover must be used to cover the sauna room or the warranty will become void. Any damage due to direct exposure to outdoor weather elements such as rain, snow, sun, wind or extreme temperatures will not be covered by this warranty. Any damages as a result of modifications made to the sauna or its components will void this warranty.**

Extent of Warranty: This limited warranty applies to products manufactured or distributed by Golden Designs, Inc. under the Golden Designs Inc. brand name, delivered in the continental United States or Canada and extends to the original purchaser at the original site of installation only. This warranty becomes valid at time of purchase and terminates either by specified time frame, owner transfer, or relocation. **Your sales receipt showing the date of purchase of the product is your proof of purchase.**

Manufacturer Warranty

All Golden Designs, Inc. products are manufactured with the highest quality appliances and are warranted to be free from defects in material and workmanship at the time of delivery. The appliance warranty is extended through the manufacturer for the product including, but not limited to: sauna control panel and connected wire harnesses. All exchanged parts and products replaced under this warranty will become the property of Golden Designs, Inc. Golden Designs, Inc. reserves the right to change for any part not covered under the existing warranty. Any parts determined to be defective must be returned to Golden Designs, Inc. at its discretion to obtain warranty service. You must prepay any shipping charges, export taxes, custom duties and taxes, or any other charges associated with the transportation of the parts. In addition you are responsible for insuring any parts shipped or returned. You must present Golden Designs, Inc. with proof of purchase documents (including the date of purchase). Any evidence of alteration, erasing or forgery of proof of purchase documents will be cause to **VOID** this limited warranty. Products on which the serial number has been defaced or removed is not eligible for warranty service.

Warranty Limitations

This warranty does not apply if the unit has been subject to negligence, alteration, modification, misuse, abuse, repairs by non-Golden Designs, Inc. authorized personnel, inappropriate installations, or any case beyond the control of Golden Designs, Inc. invalidating this warranty including but are not limited to:

- Use of lacquer or paints
- Sauna and other Golden Designs, Inc. products accessories placed on non-approved surfaces
- Outdoor applications when not protected from outdoor weather elements
- Normal wear and tear or weathering
- Use of product not in accordance with instructions

Surface cracks are not considered defects in material or workmanship, as they are normal characteristics of all woods. This includes minor cracks due to wood expansion and contraction. Note: Since the wood used in construction has been kiln dried, a certain amount of expansion and contraction occurs in the wood in a sauna environment.

Disclaimers

Golden Designs, Inc. shall not be liable for loss of use of sauna or other Golden Designs, Inc. products or other secondary or incidental or consequential costs, expense or damages - which may include the removal of permanent structures or other custom fixtures or the necessity for crane removal - arising directly or indirectly out of the use or inability to use the product. Any implied warranty shall have duration equal of the applicable warranty stated above. Under no circumstances shall Golden Designs, Inc. or any of its representatives be held liable for injury to any person or damage to any property, however arising. Specifications are subject to change without notice or obligation.

Legal Remedies

This limited warranty gives you specific legal rights. You may have other rights, which may vary from state to state.

Customer Service

For customer service, contact your authorized dealer. If you need additional information or assistance, please email Golden Designs, Inc. at info@goldendesignsinc.com or call (909) 212-5555.

*Limited Lifetime Warranty of Sauna Products is 7 years on wood structure, control panel, and applicable control panel harnesses and lights from the date of purchase. Stove/heater is covered under its manufacturer's applicable warranty.

Page Intentionally Left Blank

WARRANTY CARD

Congratulations on your purchase of an Infrared Sauna from Golden Designs, Inc. Please take the time to complete the following Warranty Card and mail it back to:

**Golden Designs, Inc.
1920 Proforma Ave
Ontario, CA 91761**

Please include a copy of your sales receipt showing date of purchase as this will serve as proof of purchase.

Warranty will be VOID if the following warranty card is not mailed back within 60 days of purchase date along with proof of purchase.

****Serial number (S/N) is located on the sauna's front panel, rear panel, or on the carton.****

DETACH HERE



WARRANTY CARD

All fields must be completed to validate the warranty.

Name: _____

Address: _____

City: _____ State: _____ Zip Code: _____

Phone Number: _____

Purchase Date: _____

Product Name: _____

Purchase From: _____

Serial Number: _____