



Owners Manual

Studio Series



Congratulations On Your New Spa

Table of Contents

Safety Information	2
Safety Instructions	3
Preparing For your New Spa	5
Spa Models + Electrical Requirements	6
Electrical Install	7
Equipment Panel Removal	8
Wiring Diagram	9
Spa Features	10
Water Quality and Maintenance	11
Testing and adjusting water chemistry	11
Filter removal and cleaning.....	12
Maintenance schedule	13
Draining and cleaning your spa	14
Vacation Care	15
Chemical Safety	15
Filter Replacement	16
Operating Instructions	17
Studio Series Display Guide	18
Warranty Certificate	26

Important Safety Instructions and Warnings

READ AND FOLLOW ALL INSTRUCTIONS

To reduce the risk of injury, do not permit children to use this product unless they are closely supervised at all times.



Warning: Children should not use spas or hot tubs without adult supervision.

Avertissement: Ne pas laisser les enfants utiliser une cuve de relaxation sans surveillance.



Warning: Do not use spas or hot tubs unless all suction guards are installed to prevent body and hair entrapment.

Avertissement: Pour éviter que les cheveux ou une partie du corps puissent être aspirés, ne pas utiliser une cuve de relaxation si les grilles de prise d'aspiration ne sont pas posées en place.



Warning: People using medications and/or having an adverse medical history should consult a physician before using spa or hot tub.

Avertissement: Les personnes qui prennent des médicaments ou ont des problèmes de santé devraient consulter un médecin avant d'utiliser une cuve de relaxation.



Warning: People with infectious diseases should not use a spa or hot tub.
Avertissement: les personnes atteintes de maladies infectieuses ne devraient pas utiliser une cuve de relaxation.



Warning: To avoid injury, exercise care when entering or exiting the spa or hot tub.

Avertissement: Pour éviter des blessures, user de prudence en entrant dans une cuve de relaxation en sortant.



Warning: Do not use drugs or alcohol before or during the use of a spa or hot tub, to avoid unconsciousness and possible drowning.

Avertissement: Pour éviter l'évanouissement et la noyade éventuelle, ne prendre ni drogue ni alcool avant d'utiliser une cuve de relaxation ni quand on s'y trouve.



Warning: Pregnant or possibly pregnant women should consult a physician before using a spa or hot tub.

Avertissement: Les femmes enceintes, que leur grossesse soit confirmée ou non, devraient consulter un médecin avant d'utiliser une.



Warning: Water temperature in excess of 38 C may be injurious to your health.

Avertissement: Il peut être dangereux pour la santé de se plonger dans de l'eau à plus de 38 C.



Warning: Before entering the spa or hot tub, measure the water temperature with an accurate thermometer.

Avertissement: Avant d'utiliser une cuve de relaxation mesurer la température de l'eau à l'aide d'un thermomètre précis.



Warning: Do not use a spa or hot tub immediately following strenuous exercise.

Avertissement: Ne pas utiliser une cuve de relaxation immédiatement après un exercice fatigant.

SAVE THESE INSTRUCTIONS

READ AND FOLLOW ALL INSTRUCTIONS

To reduce the risk of injury, do not permit children to use this product unless they are closely supervised at all times.



Warning: Prolonged immersion in a spa or hot tub may be injurious to your health.

Avertissement: L'utilisation prolongée d'une cuve de relaxation peut être dangereuse pour la santé.



Warning: Do not permit or use electric appliances (such as a light, telephone, radio or television) within 1.5 meters of spa or hot tub.

Avertissement: Ne pas placer d'appareil électrique (luminaire, téléphone, radio, téléviseur, etc.) moins de 1.5 mètres de cette cuve de relaxation.



Caution: Maintain water chemistry in accordance with the manufacturer's instructions.

Attention: La teneur de l'eau en matières dissoutes doit être conforme aux directives du fabricant.



Caution: In order to avoid a hazard due to inadvertent resetting of the thermal cut-out, this appliance must not be supplied through an external switching device, such as a timer, or connected to a circuit that is regularly switched on and off by the utility.



HYPERTHERMIA

Hyperthermia occurs when the internal temperature of the body reaches a level several degrees above the normal body temperature of 37 °C. The symptoms of hyperthermia include:

- 1) Unawareness of impending hazard;
- 2) Failure to perceive heat;
- 3) Failure to recognize the need to exit the spa or hot tub;
- 4) Physical inability to exit the spa or hot tub;
- 5) Fetal damage in pregnant women; and
- 6) Unconsciousness and resulting in the danger of drowning.



Warning: The use of alcohol or drugs can greatly increase the risk of fatal hyperthermia in hot tubs or spas.

Avertissement: La consommation d'alcool ou de drogue augmente considérablement.



Warning: The appliance is not to be used by persons (including children) with reduced physical, sensory or mental capabilities, or lack of experience and knowledge, unless they have been given supervision or instruction.

SAVE THESE INSTRUCTIONS

Preparing for your New Spa

Permitting

Most cities and county's require permits for exterior construction and electrical circuits. In addition, some communities have codes requiring residential barriers such as fencing and/or self-closing gates on property to prevent unsupervised access to the property by children. Your local inspections office can provide information on which permits may be required and how to obtain them prior to the delivery of your spa.

Prepare a Good Foundation

Damage caused by an inadequate or improper foundation is not covered by the warranty. The spa owner is responsible for providing a proper foundation. Place the spa on a solid, level foundation. If you are installing the spa indoors (not recommended), pay close attention to the flooring beneath it. Choose flooring that will not be damaged or stained. If you are installing your spa on an elevated wood deck or other structure, consult a structural engineer or a contractor to ensure the structure will support the weight of 150 pounds per square foot. An adequate drainage system has to be provided to deal with overflow water.



Plan the Best Location

SAFETY FIRST

Do not place your spa within 10 feet (3 m) of overhead power lines.

Consider Spa Use

How you intend to use your spa will help you determine where you should position it. For example, will you use your spa for recreational or therapeutic purposes? If your spa is mainly used for family recreation, be sure to leave plenty of room around it for activity. If you will use it for relaxation and therapy, you will probably want to create a specific mood around it.

Climate Privacy and View

Place the spa near a house entry if you live in a snowy or rainy environment so you have a place to comfortably change clothes. Consider seasonal changes, too. Bare trees don't provide much for privacy and don't forget to think of your neighbors' view of you, and your view of your neighbors.

Keep your Spa Clean

In planning your spa's location, consider a location where there is a clean path to and from the house. Use a mat at the spa's entrance to encourage bathers to clean their feet before entering your spa.

Allow for Service Access

If you are installing your spa near a wall or with any type of structure on the outside, such as a gazebo, remember to allow a minimum of 18" access for service.



Luxury Spa's Electrical Components

Studio Series	Description	GFCI Suggested	Wire(s) Required
Model No: 790	2.5 HP Multi-Speed Motor. 3KW Titanium Heater. 4500 Total Wattage	240V 20amp	14 Gauge
Model No: 292	2.5 HP Multi-Speed Motor. 3KW Titanium Heater. 4850 Total Wattage	240v 30amp	10 Gauge
Model No: 291, 696	3 HP Multi-Speed Motor. 3KW Titanium Heater. 5200 Total Wattage	240V 20amp	14 Gauge
Model No: 192, 594 299	3 HP Multi-Speed Motor. 3KW Titanium Heater. 5200 Total Wattage	240V 30amp	10 Gauge
Elite Series	Description	GFCI Suggested	Wire(s) Required
Model No: 595	3 HP Multi-Speed Motor. 4KW Titanium Heater. 5450 Total Wattage	240V 30AMP	10 Gauge
Model No: 006, 692	3 HP Multi-Speed Motor. 4KW Titanium Heater. 6350 Total Wattage	240V 30AMP	10 Gauge
Model No: 693	(2) 2 HP Multi-Speed Motor. 4KW Titanium Heater. 6950 Total Wattage	240V 40AMP	8 Gauge
Model No: 591, 594CGE	(2) 2 HP Multi-Speed Motor. 4KW Titanium Heater. 7350 Total Wattage	240V 40AMP	8 Gauge

*Note: A GFCI circuit is required. Using the suggested size will ensure proper operation. Call Customer Service for any additional questions 866-220-7405.

240 Volt Electrical Installation



Warning

The electrical circuit must be installed by an electrical contractor and approved by a local building or electrical inspector.

Failure to comply with state and local codes may result in fire or personal injury and will be the sole responsibility of the spa owner.

Improper installations present hazards which can result in personal injury or property damage and void the warranty on the spa.

3-Wire System

All Luxury Spa Hot Tubs are configured with a 3-wire power connection; L1(HOT), L2(HOT), and Ground. There is no neutral. If you have a 4-wire power supply to the hot tub you must cap the neutral wire inside the hot tub panel. There must be a GFCI disconnect breaker panel at least 5' from the spa. Your GFCI Neutral wire will be connected to bus bar inside disconnect panel.

Do not remove or adjust dip switches. They are pre-configured for a 240V Installation.

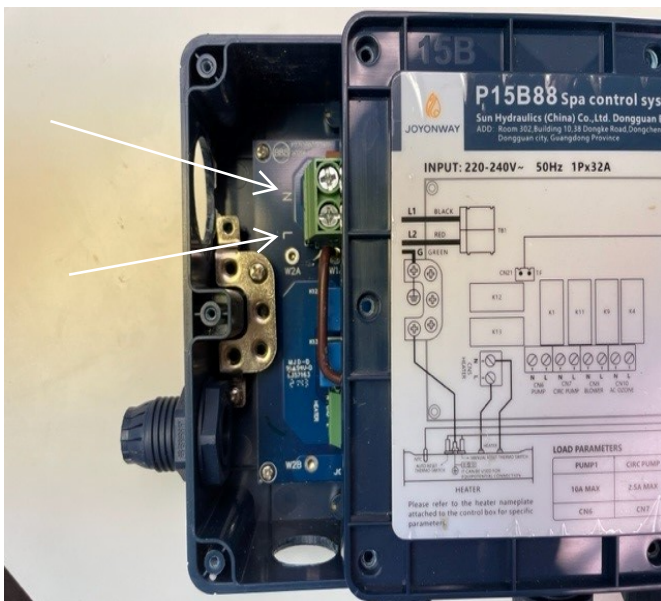

GFCI and Wiring Requirements

The power supplied to the spa must be on a dedicated GFCI protected circuit as required by ANSI/NFPA 70 with no other appliances or lights sharing the power.

Use copper wire with THHN insulation. Do not use aluminum wire.

When NEC requires the use of wires larger than 6 AWG, install a junction box near the spa and use 6 AWG wire between the junction box and the spa.

Wire runs over 85 feet must increase wire gauge to the next lower number.

Means for disconnection must be incorporated in the fixed wiring in accordance with the wiring rules.

All Luxury Spa Hot Tubs are configured with a 3-wire power connection; L1(HOT), L2(HOT), and Ground. There is no neutral. If you have a 4-wire power supply to the hot tub you must cap the neutral wire inside the hot tub panel. There must be a GFCI disconnect breaker panel at least 5' from the spa. Your GFCI Neutral wire will be connected to bus bar inside disconnect panel.

Testing the GFCI Breaker

Test the GFCI breaker prior to first use and periodically when the spa is powered. To test the GFCI breaker follow these instructions:

1. With spa operating, press the TEST button on the GFCI. The GFCI will trip and the spa will shut off.
2. Reset the GFCI breaker by switching the breaker to the full OFF position, wait a moment, then turn the breaker back on. The spa should have power again.

Point of Entry for Electric Service

Luxury Spas Hot Tubs are equipped with a designated entry port for the Spa power supply (refer to photo)



Panel Removal



In order to remove your panel to access your controls and Bluetooth module, remove the screw covers from the center or sides of the panels. (Arrows shown for reference). Once you've removed the screws, pull outward on the panel to remove it. To reinstall simply reverse your steps making sure to align the white clips on the backside of your panel. Once aligned press the panel inward to secure and re-attach your screws.

GFCI Wiring Diagram (North America 240V 60hZ)



WARNING:

The electrical circuit must be installed by an electrical contractor and approved by a local building or electrical inspector. Failure to comply with state and local codes may result in fire or personal injury and will be the sole responsibility of the spa owner. Customer must provide a disconnect in the fixed wiring. Improper installations present hazards which can result in personal injury or property damage and void the warranty on the spa.

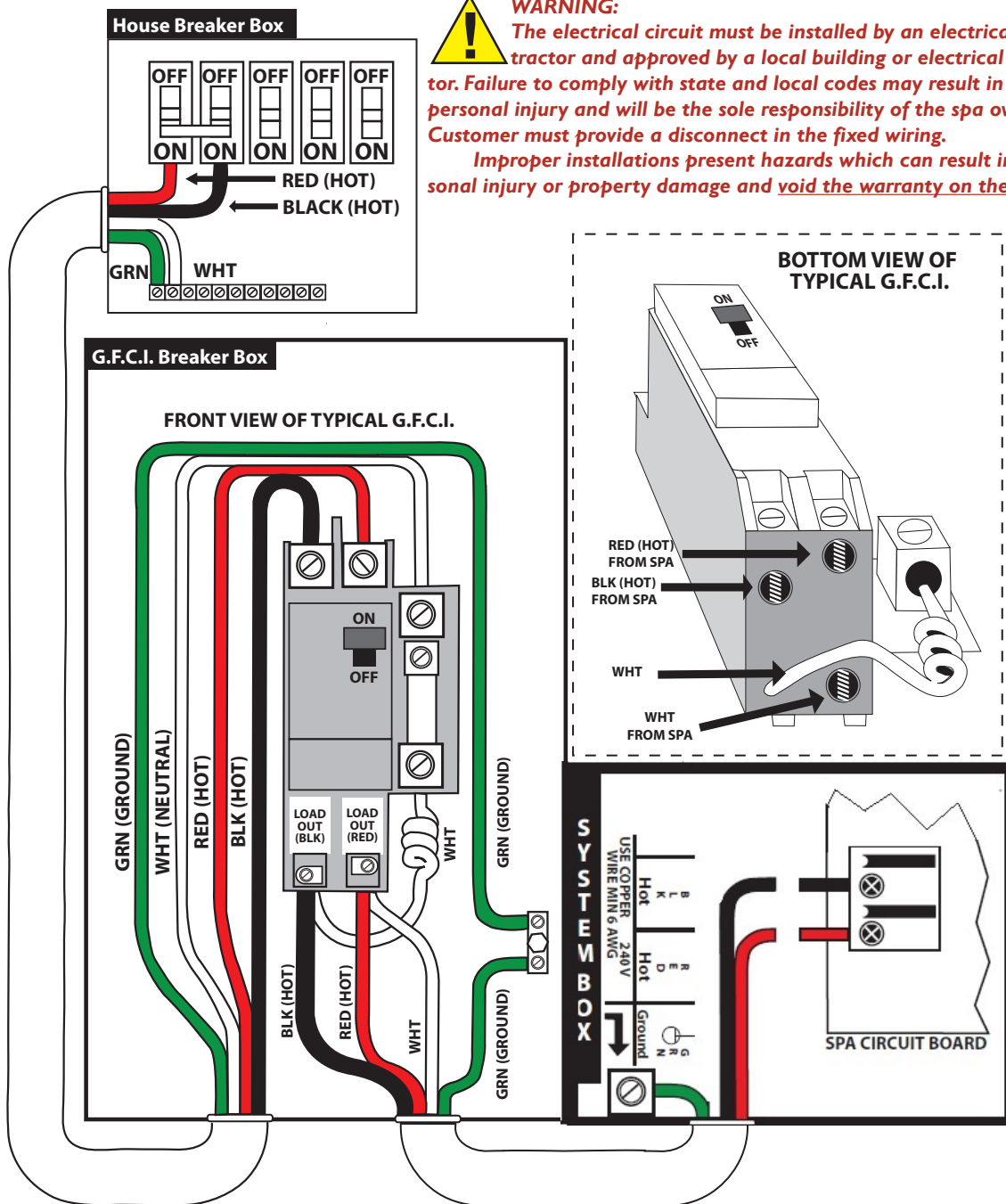

IF THE NEUTRAL WIRE FROM THE SPA IS NOT CONNECTED DIRECTLY INTO THE LOAD NEUTRAL LUG ON THE GFCI BREAKER, THE BREAKER WILL TRIP CONSTANTLY. IF YOUR GFCI BREAKER DOES NOT HAVE A LOAD NEUTRAL LUG AND PIGTAIL WIRE, IT CANNOT BE USED WITH THE SPA.

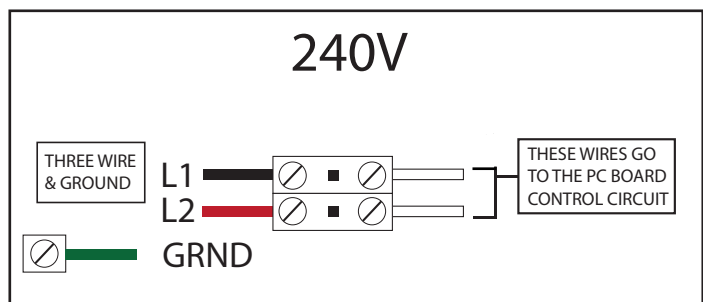

SPA FEATURES



1.) All electronic features of the spa except the Bluetooth are controlled by the control pad.



2) Air adjuster handles let you adjust the amount of pressure at the designated jets by turning the handle left or right.



3) Water diversion handles turn the jet pressure up or down at each seating location by turning the handle left or right.



4) Hydromax rotating jets provide intense massage for deep tissue penetration.

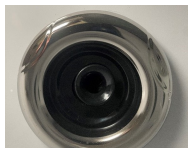

5) Hydromax adjustable directional jets provide targeted massage to pinpoint specific areas of need.



6) Hydromax power-stream jets are positioned throughout the lower back and leg areas for pinpoint massage and muscle trigger points.



7) Hydromax pulsating jets provide a soothing stream of water for a complete foot massage.



8) Air Bubble jets produce thousands of bubbles that drift around your body enhancing the sensation of float-ability while putting you in a state of relaxation.



9) Spa Drain allows you to drain the spa quickly for changing out the water.



10) Water intake grates allow water circulation through the motor and heater and out through the jets.



11) Chroma therapy lighting system provides up to 7 color changing LED mood lights for relaxation and ambiance.



12) Pillow - All models come with one or more comfortable headrests.



13) Our cores are engineered and molded (not drilled PVC) which allows for the even flow of water through the entire cartridge.



14) Bluetooth Connection- Spa models equipped with a Bluetooth speaker system require a 4-digit PIN code to connect to your smartphone. The name of the Bluetooth system on your spa is BT40. The 4-digit PIN code to access the BT40 Bluetooth is displayed on the outside of the Bluetooth module. (see photo).



15) The water level gauge shows the proper water level for your hot tub.

Water Quality and Maintenance

Testing and Adjusting Water Chemistry

- Before using your spa, it is important to test the water so that it maintains the correct chemical balance. This will ensure water quality, clarity and help keep your spa equipment in good condition.
- You will need to test and adjust the chemical balance of your spa water. Although this is not difficult, it needs to be done regularly.

There are 2 types of testing methods

- The reagent test kit is a method which provides a high level of accuracy. It is available in either liquid or tablet form.
- Test strips are a convenient testing method commonly used by spa owners.
- You can purchase the test kits and chemicals locally or from our website
www.luxuryspasusa.com

Balancing the Total Alkalinity

- Total alkalinity (TA) is the measure of the total levels of carbonates, bicarbonates, hydroxides, and other alkaline substances in the water. TA can be considered a pH buffer. It is the measure of the ability of the water to resist changes in pH level.
- **The recommended total alkalinity is 80 - 120 ppm.**
- If the TA is too low, the pH level will fluctuate widely from high to low. Low TA can be corrected by adding alkalinity increaser.

- If the TA is too high, the pH level will tend to be too high and may be difficult to bring down. High TA can be corrected by adding pH decreaser.
- When the TA is balanced, it normally remains stable, although adding water with high or low alkalinity will raise or lower the TA level.

Balancing the Calcium Hardness

- Calcium hardness (CH) is a measure of the total amount of dissolved calcium in the water. Calcium helps control the corrosive nature of the spa's water and is why soft water is not recommended. The low calcium content of soft water is very corrosive to the equipment and can cause staining of the spa shell.
- **The recommended calcium hardness is 150 - 200 ppm.**
- If the CH is too low, add liquid hardness increaser.
- If the CH is too high, dilute the spa water with soft water or, if this is not available, add stain and scale defense.
- When the CH is balanced, it normally remains stable, although adding soft water or very hard water will raise or lower the CH level.

Balancing the pH Level

- The pH level is the measure of the balance between acidity and alkalinity.
- **The recommended pH is 7.2 - 7.6.**
- If the pH is too low, it can cause corrosion of metal fixtures and the heating element.
- If the pH is too high, it can cause scaling by allowing metals or minerals to form deposits and stain spa surfaces.

Too alkaline, causes scaling	8.2	↓ Decrease the pH level.
	8.0	
	7.8	
Ideal balance	7.6	
	7.4	
	7.2	
Too acidic, causes corrosion.	7.0	↑ Increase the pH level.
	6.8	
	6.6	

Ozone

Ozone is a natural purifier. Chemically known as O₃, it is produced from simple oxygen molecules in our atmosphere. Ozone is produced in nature from lightning during electrical storms and from ultraviolet rays from the sun. It forms our protective ozone layer. Your spa's ozone generator is designed to duplicate this natural sanitizer. Ozone breaks down and oxidizes oils, suntan lotions, sweat, urea, etc. from spa water more effectively than commercial oxidizers. Ozone works with chlorine or bromine systems in your spa to destroy bacteria and viruses and will do so more effectively. Ozone only leaves simple oxygen in the water as a by-product.

If your spa is equipped with an ozone generator it will automatically produce ozone, but it cannot be used as the sole means of maintaining safe spa water. You must select and use a spa chemical sanitizer in addition to your ozone generator. The ozone generator is a wearable, non-warranty item and it needs to be replaced approximately every 2 years.

Sanitation

You will need to decide which chemical sanitizer you wish to use regardless of the presence of an ozonator. Spa owners with an ozonator still need to use a chemical sanitizer. Sanitizers kill bacteria and viruses and keep the water clean. A low sanitizer level will allow microbes to grow quickly in the spa water. Use either bromine or chlorine as your sanitizer or a non-chlorine/non-bromine sanitizer. All work well when maintained regularly. Consult your spa dealer for the right decision with regards to your lifestyle and spa usage.

NOTE: This manual will cover general chlorine sanitation only.

If Using Chlorine as a Sanitizer

- Do not use Tri-chlor tablets or liquid chlorine.
- Once a week, check the chlorine level using either a test strip or a reagent kit. Refer to product for the ideal range.
- Monitor chlorine levels of the spa water weekly. Note that chlorine dissipation rate will be faster at higher water temperatures and slower at lower temperatures.
- When you add chlorine, make sure no bathers are in the spa, open all jets and run the spa at high speed with the cover open for at least 30 minutes.

If Using Bromine as a Sanitizer

- Bromine is a very effective sanitizer that produces low chemical odors. Unlike chlorine, it can break down bacteria and other impurities to a safe level with a low burn-out rate.

Shocking the Water

- In addition to using a chemical sanitizer, you may need to shock the water. Shocking the water helps remove burned-out chemicals, bacteria, and other organic material from your spa's water and improves your sanitizer's effectiveness.
- Do not use chlorinating shock, which will damage your spa's jets and pump seals. Only use an oxidizer shock. It is an easy way to maintain chemical plans.
- For best results use the directions below.

Add oxidizer shock

- If sanitizer level temporarily reads low
- After heavy bather loads
- If water has a strong odor

Spa must be running with all of the jets on high for 30 minutes with the cover open. If necessary repeat oxidizer shock in 30 minute intervals.



The manufacturer does hereby claim no responsibility or liability for use of and quantities of the chemicals used. Read and follow all label instructions.

Filtration

Cleaning your filter regularly is the easiest and most effective single thing you can do to keep your water clear. A clogged or dirty filter will cause the heater and pump to work harder than they need to, possibly causing them to fail. The spa's heating system will only function with the proper amount of water flow through the system.

Filter Cleaning

The filter is the part of your spa that removes the debris from the water and needs to be cleaned on a regular basis to maximize your spa's filtering performance and heating efficiency.

In addition to spraying off the filter weekly to remove surface debris, your filter should be deep cleaned periodically to dissolve scale and particles that get lodged deep within the filter fibers and impede the filtration process. Even if the filter looks clean, scale and particles can clog the fibers and prevent water from flowing through the filter resulting in the most common spa problem – no heat, caused by a dirty filter.

We recommend you clean your filter once a month and replace it once every 6 months or as necessary.

- Remove the filter with the spa off.
- Place the dirty filter into a bucket of water deep enough to cover the filter. Add 8 oz of liquid filter cleaner to the bucket of water.
- Soak the filter for a minimum of 24 hours.
- Spray pleats of the filter with a water hose.
- Reinstall the filter.

Tip: Keep a spare filter to use in the spa while the dirty filter is being deep cleaned.

Ozonator Operation

Your Luxury Spas Hot Tub is equipped with an ozonator to help sanitize the water. The ozonator also helps break down body oils and other biodegradable materials to keep the water pure and clean. The ozonator works automatically when the circulation pump is on. We recommend changing the ozonator every 2-3 years. Your ozonator is located inside the hot tub panel corner.

Maintenance Schedule

Each time you refill the spa

Follow the Filling and Starting procedure, sections 7-10 on page 12.

Prior to each use

Test the spa water using either test strips or a reagent test kit. Adjust chemical levels as necessary.

Once a week

Test the spa water using either test strips or a reagent test kit. Adjust chemical levels as necessary.

Once a month

Deep clean your spa's filter.
Apply spa vinyl cleaner/protectant to vinyl spa soft cover and pillows.

Every 3-4 months

Drain and clean your spa with non-abrasive cleaner.
Polish shell with acrylic surface cleaner.
Follow the Filling and Starting procedure, sections 7-10 on page 12.

*Once a year**

Replace filter cartridge(s) if the pleats appear frayed or damaged.

*May require more frequent replacement, depending on use.

Every 2 years

Replace your ozonator.

Draining Your Spa

Your spa should be drained every 3-4 months, and refilled with fresh tap water. The following is the recommended method for draining your spa.

1. Turn off the power at the breaker.
2. Remove filter.
3. Your drain valve is located outside corner of the Service Access Side.
4. Rotate the cap and push until you feel it give, then pull the plug one notch out.
5. Once the drain plug is external, hook up the female end of the garden hose.
6. Rotate the drain plug with hose connected while applying a pulling pressure to release the water while hose is attached.
7. Let spa drain completely, then remove garden hose.
8. Apply the cap, and rotate the drain while applying a pushing pressure to lock the flow of the drain when ready to re-fill.



Water drained from your spa is safe to dispose of in your yard, septic system or in a drain. Follow all local/municipal codes and regulations for disposal.

Cleaning Your Spa

Acrylic Spa Shell

Each time you drain your spa, before you refill it you should clean your spa shell with a low detergent, non-abrasive cleaner specifically formulated to clean the spa without damaging its acrylic finish.

1. Spray cleaner directly to the spa's finish.
2. Wipe clean with a soft cloth.
3. Repeat on heavily calcified areas.
4. Wipe spa thoroughly with a wet sponge, rinsing often in a bucket of clean water.
5. Allow the spa to dry completely.

IMPORTANT: Do not use any of these products on spas full of water. Only apply to clean, cool, dry surfaces. In-correct product usage may cause water issues.

Pillow Care and Removal

You can remove the pillows for cleaning and maintenance quickly and easily. This method works for all types of pillows.

1. Your spa pillows should be removed routinely for cleaning and maintenance to ensure they stay in good condition and do not deteriorate. If you don't plan on using your hot tub for a while we recommend removing and storing the pillows.
2. You can remove any Luxury Spas pillow by gently pulling the edges away from the hot tub. The pillow will release from the mounting clip on each side. The pillow can be re-installed by pressing the pillow back over top or side of the clips based on the pillow type.
3. Your spa pillows can be cleaned with any non-abrasive spa pillow cleanser and conditioner.



Vacation Care

You can leave your spa unattended for up to two weeks if you follow these instructions.

- ALWAYS lock your cover using the cover locks if you plan to be away from home and the spa is filled with water.
- Follow the water quality instructions starting on page 20.
- Shock the water (add either chlorine or bromine sanitizer).
- When you return, check water chemistry and adjust accordingly.
- **If you will not be using your spa for longer than 14 days and a spa maintenance service is not available we strongly recommend you drain and winterize your spa.**

Chemical Safety

Read and follow all printed instructions listed on bottles and packages. Failure to follow chemical directions may result in serious injury, sickness, or even death.

Add chemicals to the center of the spa with the pump running. Make sure the water is heated. Never add chemicals to cold water, as this will effect chemical action. Also, never add chemicals directly into the skimmer.



WARNING!

Never add chemicals to your spa while bathers are in the spa!



Do not exceed chemical dosages as recommended on chemical bottles and packages.



Never change chemical brands or types without completely draining, flushing and thoroughly cleaning the spa and cover first.



WARNING!

Never mix chemicals together.



Do not allow chemicals to come in contact with skin, eyes or clothing. Remove and wash clothing that may have been exposed to chemical contact prior to wearing them again.



Inhaling or ingesting chemicals will cause serious injury, sickness, or even death.



Chemicals must be stored completely out of the reach of children in an area that is well vented, cool, and dry. Failure to provide a proper area for chemical storage may result in serious injury, sickness, fire explosion and even death. Do not store your chemicals inside the equipment area of your spa.

Filter Replacement Guide

Hot Tub Model	Filter Model	Filter Size
693	200/Short	8.07in x 5.90in
094D	4CH-949/Short	9.84in x 4.92in
790D	4CH-949/Short	9.84in x 4.92in
591	335/Long	13.18in x 4.92in
594	335/Long	13.18in x 4.92in
595	335/Long	13.18in x 4.92in
006D	4CH-949/Long	13.93in x 5in
192D	4CH-949/Long	13.93in x 5in
194D	4CH-949/Long	13.93in x 5in
291D	4CH-949/Long	13.93in x 5in
292D	4CH-949/Long	13.93in x 5in
299D	4CH-949/Long	13.93in x 5in
594D	4CH-949/Long	13.93in x 5in
598D	4CH-949/Long	13.93in x 5in
692D	4CH-949/Long	13.93in x 5in
692S	4CH-949/Long	13.93in x 5in
696D	4CH-949/Long	13.93in x 5in
696D	4CH-949/Long	13.93in x 5in

Now that you know the basics, let us show you how to set up your new Luxury Spa Keypad





Studio Series Display User Guide

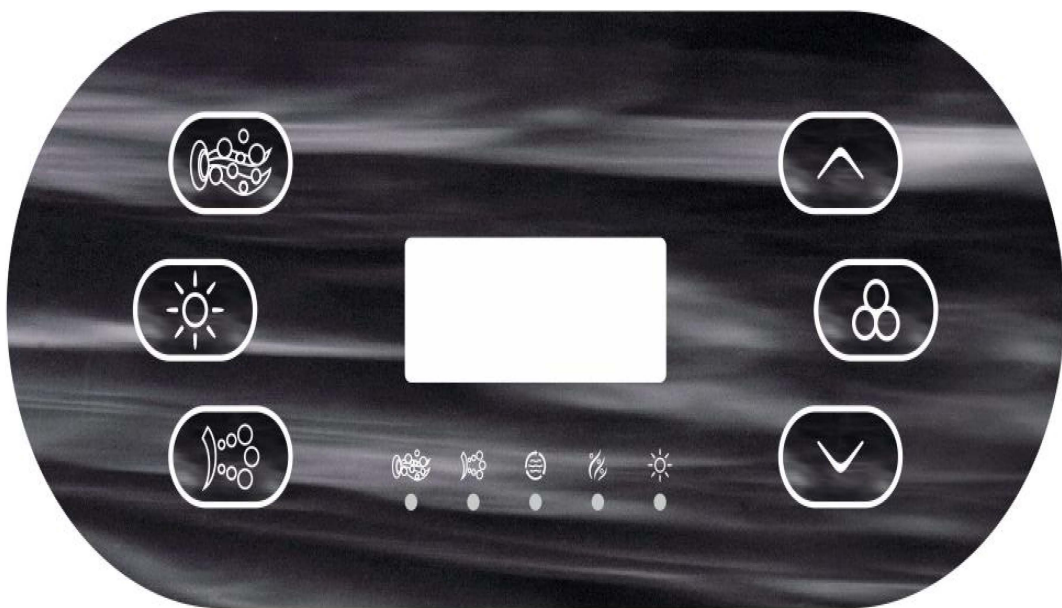

Questions? Call 866.220.7405

Programming and setting up your spa

1 CHANGING CELCIUS TO FARENHEIT

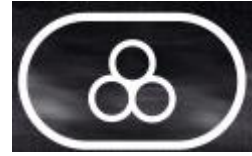

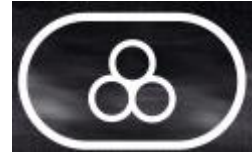

1.1 When the control system is powered on , touch “” about 5 seconds , it will change the temperature unit (°C or °F) .

2 SETTING THE WATER TEMPERATURE

2.1 When the system is on but not in the setting state, touch



“” and “” ,it will change the temperature setting.

3 SETTING THE CLOCK

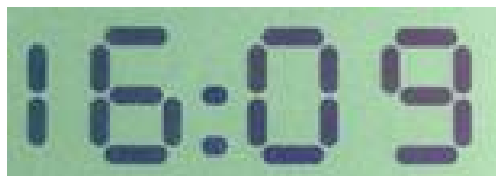

Setting clock interface

3.1 When the system is powered on , touch “”the LCD will flash the HR

character,then you can adjust the hours by “” and “”

3.2 When the spa is powered on, touch “”, the Minute character will then start flashing on the screen. Then you can adjust the minutes by touching

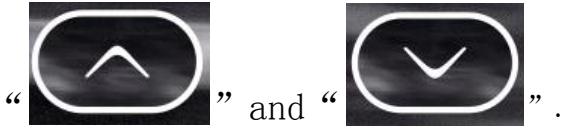



2 SETTING WATER CYCLE TIME (SELECT MODELS)



The interface for setting start time of the time period of the timed water cycle



The interface for setting the end time of the time period for the scheduled water cycle

2.1 LCD screen shows “”, “” which shows the start time and the end time.

Base System Features and Functions

1 WATER PUMP



1.1 Use this button to turn the water pump on/off.

The water pump will turn off automatically after 30 minutes.

2 AIR PUMP



2.1 Use this button to turn the optional air pump on/off. The air pump will turn off automatically after 30 minutes.

3 LIGHT



3.1 Use this button and the light will turn on/off when power is on. It will turn off automatically after 2 hours.

4 SETTING WATER CIRCULATION TIMING

4.1 If your spa is equipped with the optional circulation pump, set the clock first to make sure the time is accurate before using this function .

4.2 If your spa is not equipped with the optional circulation pump, pressing the pump button twice will put the pump in low mode to circulate the water when the power is on.

4.3 Set the timing of the circulation pump according to the steps listed in "Setting Water Cycle Time".

5 OZONE

5.1 Ozone will be off when water pump and air pump are working.

5.2 When the pump and air pump is off, the heating circulation pump or the timing water cycle will start. The ozone disinfection system will turn on automatically. When the heating circulation pump and the timing water cycle are off, the ozone disinfection system will turn off automatically.

6 HEATING

6.1 When the water temperature is below the set temperature, the heater will come on and the control system will power on at the same time. The heater will then stop heating when water temperature reaches the set temperature. "Refer to Setting The Temperature" in the Settings Section.

7 Anti-freezing protection

The spa is equipped with anti-freezing protection. If the water temperature drops to less than 6 °C (43 °F), the heating function will turn on automatically until the water temperature reaches 10 °C (50 °F). The heater will then turn off automatically .

2.2 When the spa is powered on, touch  to set the timing water cycle time period, when the corresponding time flashes it can be adjusted by touching the up or down arrows:



and



2.3 The system will save your settings automatically after the water cycle time is set.

ERROR CODE TROUBLESHOOTING

FAULT CODE	FAULT MESSAGE	HOW TO FIX
E1	Temperature sensor fault	Please check the temperature sensor and its connection and replace it if necessary.
E2	The temperature is beyond the normal range	<p>The control system detected that the temperature of the temperature sensor was too high. When the heater is started, this failure may occur when there is no water in the water pipe or the flow is small during heating. Please ensure that there is water in the SPA . If this information appears multiple times over a period of several days, contact Luxury Spas or your spa service center.</p> <p>The control system detects that the temperature of the temperature sensor is too low. Please pay attention to frost resistance.</p>
E4	The heater is off	Indicates that the temperature of the heating tube is too high. When the thermostat is started, this failure may occur when there is no water in the water pipe or when the flow is small during heating. Please ensure that there is water in the SPA . If this failure occurs many times within a few days, please contact us.
E5	Panel and electricity box failure	Please check the connection line between the control panel and the house electrical panel or sub panel and replace it if necessary.

Indicator Lights and what they mean

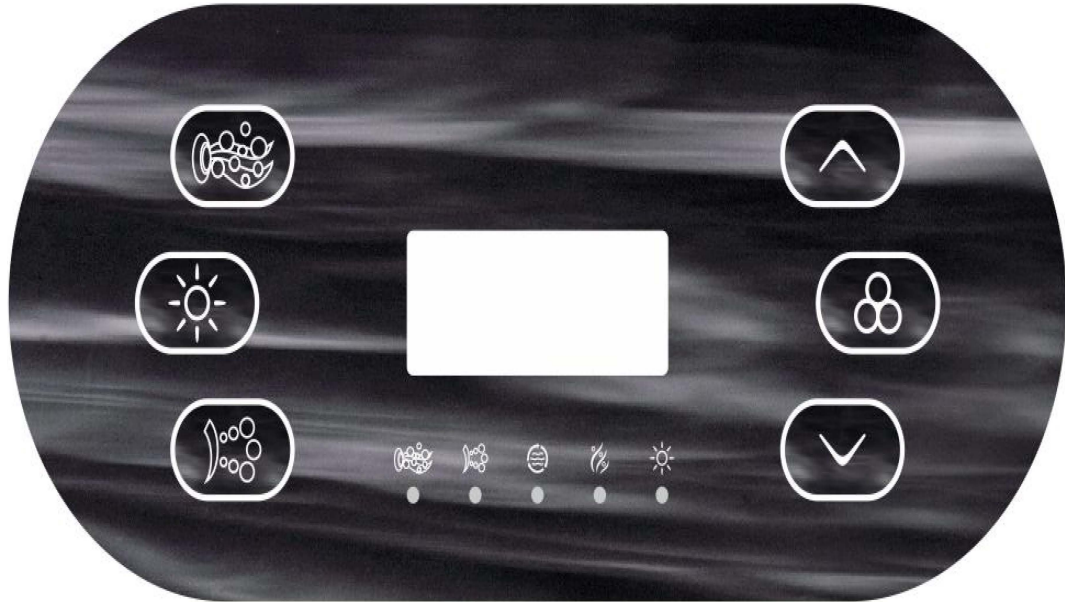

Water Pump Air Pump Circulation Pump Heater Light



Water Pump

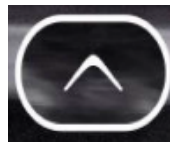

Indicator Arrows



LED Lights



Air Pump (If Equipped)

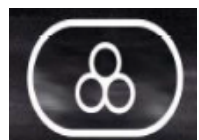

Programming Button

Luxury Spas USA Warranty

This warranty covers all Luxury Spas USA branded hot tubs which are purchased directly from Luxury Spas USA Ltd. This warranty certificate is non-transferable.

Shell Warranty - 10 years

Luxury Spas USA warrant the shell against water loss to the customer arising from structural failure for a period of 10 years. Luxury Spas USA warrants the acrylic shell surface against water loss arising from defects in materials, including cracks, blisters, peeling and delamination for a period of 5 years. The warranty coverage includes all parts and labor necessary for repair.

Electrical Equipment and Plumbing - 2 years

Luxury Spas USA warrant all major spa components – specifically, the pumps, the heater and the control system – against malfunction arising from defects in materials and workmanship, for a period of 2 years. The electrical equipment and plumbing warranty covers the parts only necessary for repair. Labor is not covered under the major spa component warranty. Water leaks from pump and plumbing unions are not included under the warranty coverage.

Spa Components - 2 years

Luxury Spas USA warrant all other spa components, including but not limited to LED lights, fuses, topside control unit, diverter caps, cover clips, and jet inserts against malfunction arising from defects in material and workmanship for a period of 2 years to the customer. Includes only parts necessary for repair. Labor costs are not included.

Spa Cover Warranty

Luxury Spas USA warrant the spa cover to be free from defects in material for 30 days from the date of delivery as they are open to elements and/or chemical damage.

Warranty Terms

All warranties apply to the original customer, at the original address that the spa was installed. Your limited warranty does not include the cost of shipping parts back to Luxury Spas USA, or to an authorized repair center. This warranty does not include costs incurred using non-authorized repair centers. Customers must have written consent from Luxury Spas USA before proceeding with any repair that is to be reimbursed by Luxury Spas USA. In all cases, Luxury Spas USA has sole responsibility for determining the cause and nature of a fault. Luxury Spas USA reserve the right to provide a replacement spa of equivalent value if we deem it to be necessary. In such a circumstance, the customer shall be responsible for the cost of moving and installing the new spa into position.

Performance

The Customer must report any discovered fault to Luxury Spas USA within 10 business days. A Luxury Spas technical representative will then diagnose the issue over the telephone and may suggest possible solutions for the customer to attempt. If after these suggestions fail to resolve the issue, Luxury Spas will then arrange for a repair technician to visit the site. If the repair technician

is sent out and discovers there is no issue, or the issue is not manufacturing related, then customer will be responsible for the service call. If a manufacturing related issue is discovered there is no charge for the technician visit. If the technician determines that any fault is not covered under this warranty, the customer is solely responsible for the cost of any parts and or labor charges.

Additional Warranties

The spa cover, steps, light bulbs, headrests, skirt and filter are warranted to be free of defects in workmanship or materials for thirty (30) days from the date of delivery. All other factory-installed components, including but not limited to the cabinet, frame, LED light system, stereo and related components, speakers, skimmer, and jets, are warranted against malfunction due to defects in workmanship or materials for one year from the date of purchase.

Exclusions

This Limited Warranty is void if Luxury Spas or its designated representative determines that the spa has been subjected to alteration, neglect, misuse or abuse, or freight damage caused by the common carrier; or if the failure is caused by accident, acts of God or other causes beyond the control of Luxury Spas. Neglect, misuse and abuse include any installation, operation or maintenance of the spa other than in accordance with the instructions contained in the owner's manual provided with the spa, including but not limited to the failure to maintain proper water chemistry and chemical balance and the use of abrasive or improper cleaners. This Limited Warranty does not provide coverage for any item attached to or installed on the spa after the date of sale or for gaining access to any component for repair or replacement. Spa units used in a commercial application are excluded from any coverage whatsoever.

Damage to headrest pillows reported beyond the day of delivery will not be covered under warranty. Headrest pillows are to be removed from the spa when not in use.

Warranty service will be provided only if the original invoice or sales receipt is presented with the defective product within the guarantee period. We may refuse free-of-charge guarantee service if these documents are not presented or if they are incomplete or illegible.

Disclaimers

Except as specifically provided by the law, Luxury Spas and its representatives shall not be liable for any injury, loss, cost or other damage, whether incidental or consequential, arising out of any defect covered by this Limited Warranty, including, without limitation, loss of use of the spa and cost for removal of defective product, even if Luxury Spas has been advised of the possibility of such damage. The liability of Luxury Spas under this Limited Warranty, if any, shall not exceed the original amount paid for the defective product. Coverage under this Limited Warranty shall commence as of the original date of purchase and the duration of such coverage shall not extend for any reason whatsoever beyond the stated time periods. These disclaimers shall be equally applicable to any service provided by Luxury Spas USA and its representative.