



THE COLDTUTURE SYSTEM USER MANUAL

TABLE OF CONTENTS

PAGE - 03

WARNINGS

PAGE - 04

CONTROL PANEL

PAGE - 05

PARTS REFERENCES

PAGE - 07

SETUP INSTRUCTIONS

PAGE - 10

WIFI / APP SETUP

PAGE - 13

TAKEDOWN INSTRUCTIONS

PAGE - 15

WATER MAINTENANCE

PAGE - 16

RECOMMENDED ROUTINE MAINTENANCE

PAGE - 17

TROUBLESHOOTING

PAGE - 19

LIMITED WARRANTY

YOU MUST CONSULT WITH A MEDICAL PROFESSIONAL to ensure you are medically fit prior to using your Coldture Tub. It is important you understand the relevant risks, seriousness of risks and potential consequences of using the tub, either with cold or hot water. As with any receptacle for water, there is the risk of drowning which can be fatal. It is your responsibility to ensure minors are always properly supervised in the Coldture Tub and anyone who enters can safely stay above water. The Coldture Tub should never be used when impaired under any substance, which could affect your ability to remain awake, conscious and operating with a clear mind. With cold water, there is the risk of hypothermia and anyone using the tub should exercise extreme caution and sensible judgment to exit the Coldture Tub before the onset of any

such complications. Extreme caution should be used because as your body becomes colder, movements and circulation in your body may slow down. The use of the Coldture Tub with hot water can result in nausea, dizziness and light-headedness. Caution and sensible judgment must be used to prevent any such side effects. Always leave the tub before you are experiencing any such symptoms. You also understand that by using the Coldture Tub, you will be solely responsible for its hygiene, sanitation and maintenance. The Coldture Tub is only to be used for the explicit purpose of being a recreational cold or hot tub and for no other purposes. The best way to avoid any of the risks of using the Coldture Tub is to remain aware of how you are feeling and err on the side of caution.

DROWNING

- To reduce the risk of injury, do not permit children to use this product unless closely supervised at all times.
- Risk of Accidental Drowning. Extreme caution must be exercised to prevent unauthorized access by children.
- Tub Cover is not a Safety Cover.

ELECTRICAL

- This product is provided with a ground-fault circuit-interrupter integrated. The GFCI must be tested before each use. To perform the test, first ensure the blue Power Switch on the back of the Chiller is up in the "on" position and then press the orange "T" Test Button above the Power Switch. The Power Switch should flip to the down "off" position. Now flip up the Power Switch to the "on" position. If this test does not cause the Power Switch to turn off, do not proceed, and contact support for assistance. **DO NOT USE IF THIS TEST FAILS.**
- Do not handle electrical outlet with wet hands.
- Do not permit any electric appliance within 5 feet of this product.
- Only use this product with 120v/60hz electrical circuit; outlet must be grounded appropriately.
- Never submerge machine or expose to direct water spray.

HEALTH

- Elderly persons, pregnant women, infants, and those with health conditions requiring medical care - especially cardiovascular and neurological - should consult with a physician before using this product.
- Hot and Cold Water Immersion while under the influence of alcohol, narcotics, drugs or medicines may lead to serious injury and is not recommended.
- Do not use alone.
- Long exposure may result in hyper or hypothermia, nausea, dizziness, or fainting.
- Do not exceed 5 minutes in cold or 30 minutes in hot water; excessive exposure may be harmful to health.
- Always enter and exit the tub slowly and cautiously. Wet surfaces are slippery.

ADVISORY:

- Pool owners may need to comply with local or state laws relating to childproof fencing, safety barriers, lighting, and other safety requirements. Customers should contact their local building code enforcement office for further details.
- Keep hair, fingers, towels, and other items away from the fan.
- Only professional technicians may work on the system.

WARNING:

This product can expose you to chemicals including lead, which is known to the State of California to cause cancer.

For more information, go to www.P65Warnings.ca.gov

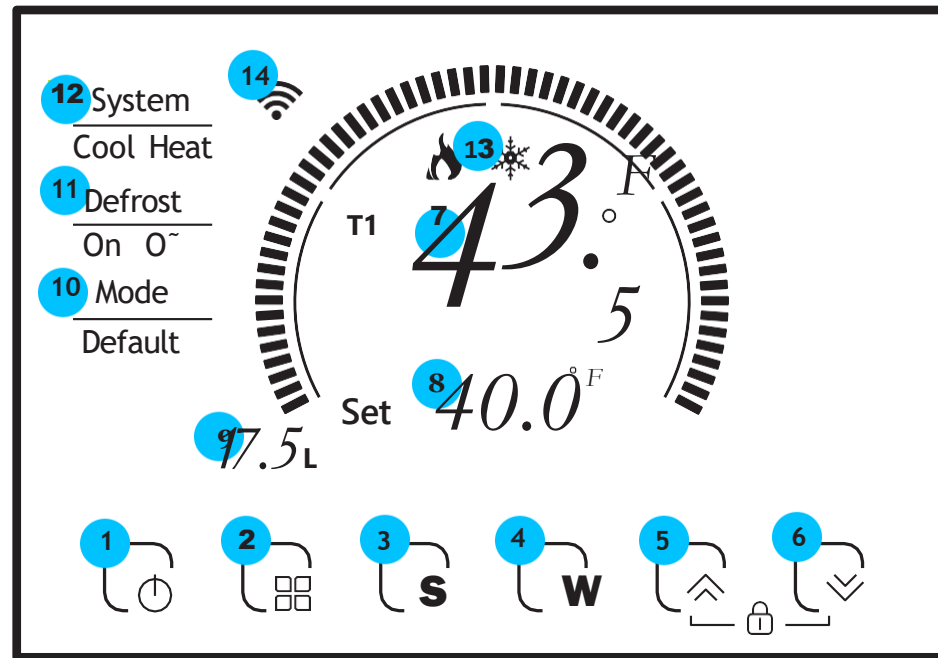
**1 - POWER BUTTON**

Press for 2 seconds to turn the *Chiller* On or Off.

2 - MODE BUTTON

Press for 5 seconds to switch between Fahrenheit and Celsius.

3 - SETTING BUTTON

Press for 1 second to change temperature setting.

4 - WIFI ACTIVATION BUTTON

Press for 5 seconds to engage WiFi setup mode.

5 - UP ARROW

Press to increase temperature after pressing Setting Button.

6 - DOWN ARROW

Press to decrease set temperature after pressing Setting Button.

5 + 6 - CHILD LOCK

Press both for 5 seconds to engage Child Lock.

7 - TUB TEMPERATURE

Shows temperature of water coming from the Tub.

8 - SET TEMPERATURE

Shows the desired temperature setting for the *Tub*.

9 - WATER FLOW INDICATOR

Shows the water flow of *Chiller* in liters per minute.

10 - MODE INDICATOR

Shows mode *Chiller* is operating in ("Default" is normal function).

11 - DEFROST INDICATOR

Shows if *Chiller* is defrosting. Will display "On" or "Off."

12 - COOL/HEAT SYSTEM INDICATOR

Shows if *Chiller* is actively cooling ("Cool"), heating ("Heat"), or on standby (blank).

13 - COMPRESSOR STATUS

Shows when compressor is running.

14 - WIFI INDICATOR

Shows Wifi status. Solid for connected, blinking for setup mode. Blank for disconnected.

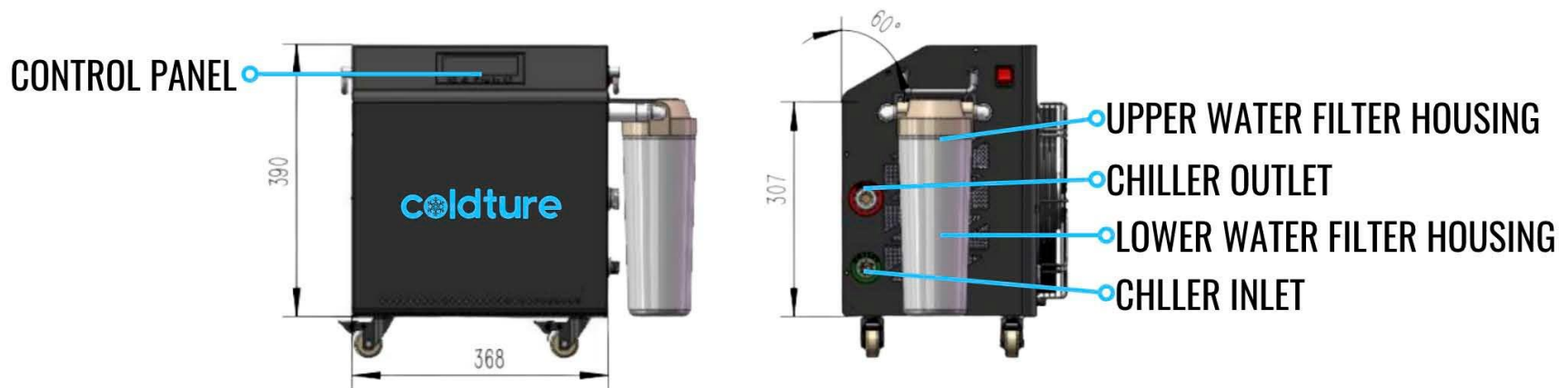

CHILLER

The main unit which chills/heats, circulates, and filters the water.

PROTECTIVE CAPS

The protective caps that thread on the Chiller Inlet and Outlet ports.

CHILLER HOSES

The flexible hoses are used to flow water from the Coldture Tub to the Chiller. Hose Connection Fittings

The fittings on the end of each hose. They connect the Chiller Hoses to the Chiller Inlet/Outlet and Tub Valve Fittings.

Hose O-Rings

The o-rings in the hose connections. These are vital for water-tight and air-tight connections with the Chiller Hoses and Tub or Chiller.

CHILLER INLET (RED)

The connection on the chiller, which incoming water enters through. This is marked with a red ring.

CHILLER OUTLET (GREEN)

The connection on the chiller, which outgoing water leaves through. This is marked with a green ring.

CONTROL PANEL

The visual readout including Tub Temperature, Set Point, and the Control Buttons (detailed in Control Panel section).

EXTERNAL WATER STRAINER

The assembly of parts that is used to prevent any debris from entering the Chiller. It connects to the Chiller Inlet (red) and is made up of the Water Strainer Cover, Strainer O-Ring, and Inner Water Strainer.

- **Inner Water Strainer** 

The cylindrical mesh element that attaches to the Chiller Inlet (red).

- **Strainer O-Ring**

The o-ring at the base of the External Water Strainer connection (red) on the chiller

- **Water Strainer Cover** 

The metal cover that will screw on the Chiller Inlet (red) over the Inner Water Strainer

WATER FILTER HOUSING

The assembly which houses the Water Filter. Includes the Upper Water Filter Housing and Lower Water Filter Housing.

- **Filter Housing O-ring**

The filter housing o-ring is located in the Upper Water Filter Housing and is used to create an air tight connection between the Lower and Upper Water Filter Housings.

- **Filter Housing Wrench**

The wrench designed to be used when the Lower Water Filter Housing is too tight to loosen by hand. Do not use the wrench to tighten the filter housing when setting up or changing the filter.

- **Lower Water Filter Housing**

The filter housing which holds the water filter and connects to the back of the chiller (lower clear part).

- **Upper Water Filter Housing**

The water filter housing connection point (upper white part) on the rear of the chiller.

- **Water Filter**

The water filter is used to filter debris from the water running through the chiller. This is placed into the Lower Water Filter Housing.

SETUP:

Detailed setup video can be found here.

<https://youtu.be/w4vK-ZsIs98>

STEP 1) UNBOX YOUR COLDTURE CHILLER

Remove the Chiller from their shipping carton. We recommend keeping the Chiller box for future transportation needs. Select a flat, clean and smooth surface. A water source and 120v power source should be accessible.

STEP 4) INSTALL THE EXTERNAL WATER STRAINER

Remove the Protective Cap of the red "Inlet" fitting on the Chiller by rotating counterclockwise. Install the Inner Water Strainer into the red "Inlet" by turning clockwise. Next, install the silver Water Strainer Cover. This fits over the Inner Water Strainer and should be screwed to hand tight.

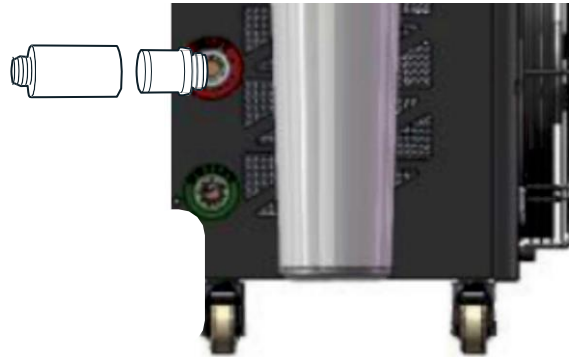

SETUP:

Detailed setup video can be found here.

<https://youtu.be/w4vK-ZsIs98>

STEP 5) CONNECT THE CHILLER TO THE TUB

First check that there is a Hose O-Ring inside each of the four Hose Connection Fittings. If not, place an o-ring from the spare parts bag. Connect the 90 degree hose side to the tub. The “Water In” fitting on the Tub should connect to the green “Outlet” on the Chiller. The “Water Out” fitting on the Tub should connect to the red “Inlet” on the Chiller. To tighten, thread on the Hose Connection Fittings and rotate clockwise. The threads should tighten easily and smoothly. If resistance is felt, try attaching the hose again. Hand tighten only. Over tightening may cause leaking or damage.

STEP 6) FILL THE TUB

Check that the Chiller Drain Cap and hoses are in place. Remove the Lower Water Filter Housing, insert a filter and fill with water. Ensure the Filter Housing O-Ring is in place in the Upper Water Filter Housing. Install the Lower Water Filter Housing by turning right if facing the back of the Chiller until hand tight. Do not use the filter wrench to tighten the water filter housing (for loosening only). The Tub can now be filled with water.

STEP 7) OPEN VALVES

Once the Tub has been filled, confirm the Tub Valve Fittings are in the open (parallel) position. Ensure this step has been completed to prevent damage to Chiller!

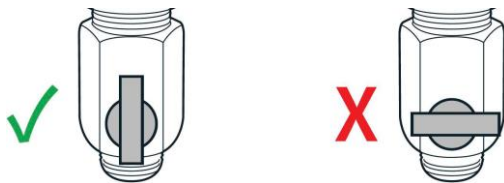
**STEP 8) POWER ON THE CHILLER**

Plug the Chiller into a standard 120v grounded power supply with 15 amp minimum circuit and test the GFCI functionality. To perform the test, first ensure the Power Switch on the back of the Chiller is up in the “on” position and then press the orange “T” Test Button above the Power Switch. The Power Switch should flip to the down “off” position. Now flip the Power Switch back up to the “on” position. If this test does not cause the Power Switch to turn off, do not proceed, and contact support for assistance. Place the Power Plug in an elevated position off the ground and away from water. Do not handle with wet hands. You may now turn on the Chiller by pressing the “Power On” button on the display screen. The Chiller may take up to 2-3 minutes to purge air from the system and will flash “o1.x” or “O2.x” while purging. Once this has been completed, this code will change to the current water temperature and the Chiller will begin cooling or heating. If the “FL” (Flow) error appears, or if this step takes longer than 2-3 minutes, check that the Valves are open, and that the hose connections and filter housing are connected properly, and then repeat this step.

SETUP:

Detailed setup video can be found here.

<https://youtu.be/w4vK-Zsls98>

STEP 9) CHOOSE YOUR TEMPERATURE

To change the set temperature, press and hold the “S” key for 1 second until the set temperature flashes. Use the up or down arrows to set your desired temperature. Press the “S” key once more to lock the setting and stop the set temperature flashing. Your Tub will reach minimum or maximum temperature in about 3 hours depending on ambient temperature and set temperature.

STEP 11) COVER YOUR TUB

Finally, put the Cover on if the Tub will not be immediately used,

STEP 10) STARTUP WATER SANITATION - Sold Separately

Prior to use, the water should be treated with the startup Sanitizer dose. The startup dose is below and should be used any time the water is replaced in the Tub.

- A. Add 6 grams (½ Bottle Cap) of Oxidizer into water.**
- B. Wait 15 minutes.**
- C. Add 4 grams (½ Bottle Cap) of Sanitizer into water.**
- D. Wait 15 minutes before use.**

Please refer to Maintenance Instructions for weekly water maintenance protocol.

SETUP:

Download and install the Tuya Smart application by scanning the QR code.

Apple: <https://apps.apple.com/us/app/tuya-smart/id1034649547>

Android: https://play.google.com/store/apps/details?id=com.tuya.smart&hl=en_US&gl=US

**STEP 1)**

Ensure the device you are using is connected to the WiFi network that you wish to connect the *Chiller* to, and open the *Tuya Smart* application.

Important Note: The *Tuya Smart* system only works with 2.4 GHz wireless networks. Many wireless networks utilize 5 GHz and may need to be configured at 2.4 GHz. Please contact the manufacturer of your Wi-Fi router for support on this matter if you experience trouble.

STEP 2)

Now you may turn on the *Chiller* if not already. Press and hold the “W” button for 5 seconds until the Wi-Fi indicator on the display flashes.

STEP 3)

Once the *Tuya Smart* app is open, you may add the *Chiller* by selecting “Add Device” on the home screen.

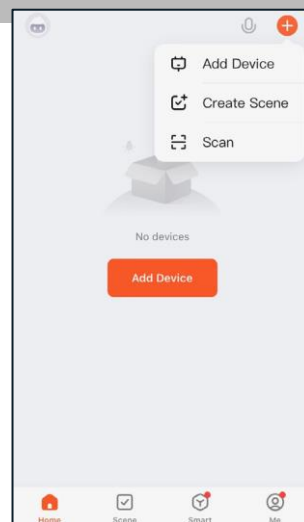
**STEP 4)**

The app should recognize the *Chiller* automatically. If not, from the menu, select “Small Home Appliance” on the left sidebar menu and then select “Thermostat (Wi-Fi).”

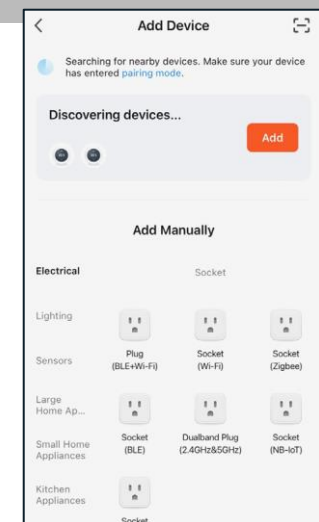

SETUP:

Download and install the Tuya Smart application by scanning the QR code.

Apple: <https://apps.apple.com/us/app/tuya-smart/id1034649547>

Android: https://play.google.com/store/apps/details?id=com.tuya.smart&hl=en_US&gl=US

**STEP 5)**

Next, the Wi-Fi Network screen will prompt to confirm the wireless network and request the password for the network.

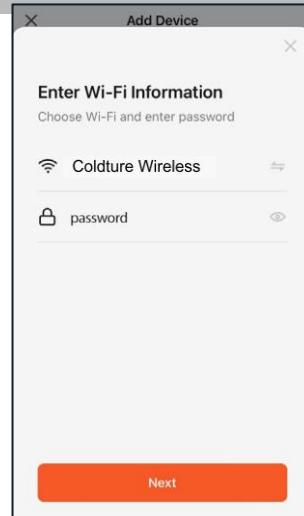
**STEP 6)**

The app will now attempt to connect to the *Chiller*. This may take up to 2 minutes. If the attempt fails, you will be asked to retry. Retry, and if it fails again, ensure you're using a 2.4 GHz wireless band and that network name and password are correct.

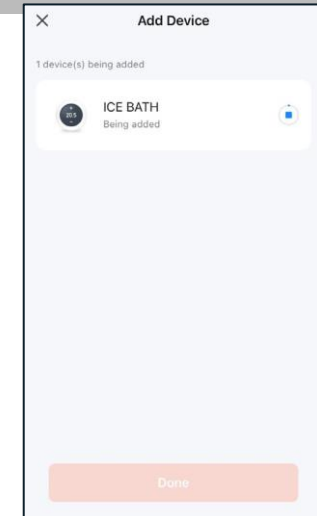
**STEP 7)**

Your *Chiller* should now be connected successfully!

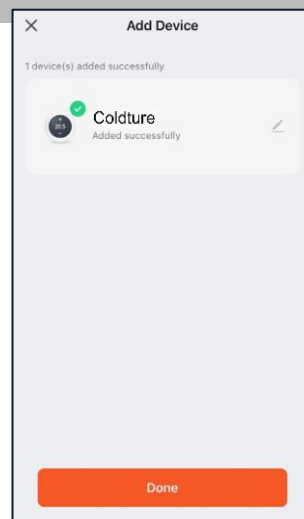

SETUP:

Download and install the Tuya Smart application by scanning the QR code.

Apple: <https://apps.apple.com/us/app/tuya-smart/id1034649547>

Android: https://play.google.com/store/apps/details?id=com.tuya.smart&hl=en_US&gl=US

**STEP 1)**

Open the Tuya app and navigate to the timing control option. Open the timing control page.

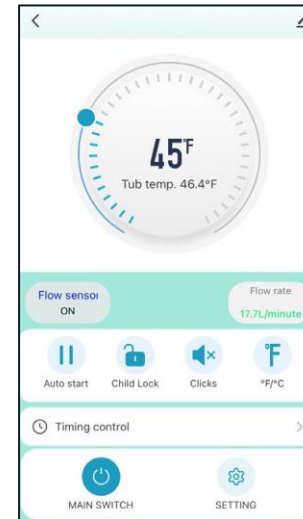

SELECT TIMING CONTROL

STEP 2)

Set the desired time and desired settings, then press "save."

SET TIME

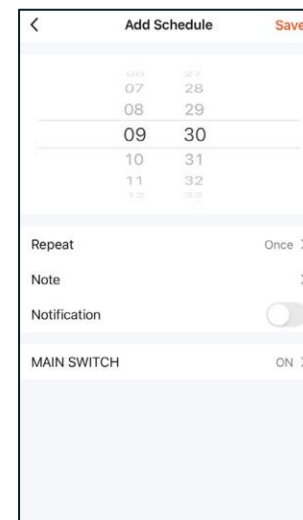

SET REPEAT IF DESIRED

SET ACTION DESIRED (ON OR OFF)

STEP 1) TURN THE CHILLER OFF

Turn the Chiller off by toggling the Power Switch on the back of the Chiller to the down “off” position. Turn the valves at the tub connection to the “closed” position.

STEP 2) DRAIN THE TUB

Disconnect the “Water In” hose from the Chiller.

Direct the hose to the desired area for drainage and open the valve.

Water will flow out of the hose until it reaches the Lower Water Fitting.

The remaining water can be removed by turning the tub over.

STEP 3) DISCONNECT THE HOSES

Once the Tub is drained, the hoses can be disconnected from the Tub and Chiller by rotating the Hose Connection Fittings counterclockwise, and the Chiller can be unplugged.

STEP 4) DRY THE TUB

The Tub should now be dried inside and out (including bottom) with a towel to prevent mildew. This is also a good time to clean the Tub with mild soap and water.

STEP 9) DRAIN THE CHILLER

Unscrew and empty the Lower Water Filter Housing. Then, unscrew the External Water Strainer. The unit can be tipped slightly to the side to remove water inside the Chiller. Once drained, replace the Chiller Drain Cap and Lower Water Filter Housing. Finally, replace the protective Chiller Fitting Caps on the Inlet/Outlet connections.

INITIAL SETUP:

- Add 6 grams (1/2 bottle cap) of Oxidizer into water
- Wait 15 minutes

- Add 4 grams(1/2 bottle cap) of Sanitizer into water
- Wait 15 minutes before entry into Tub

WEEKLY MAINTENANCE**SUMMARY:**

There's 3 simple steps for weekly maintenance that take about 15 minutes to ensure that your chiller is running properly and the water is clean and clear. The first step is checking the water chemistry, then the External Water Strainer, then the Water Filter.

STEP 1) CHECK THE CHEMISTRY

- Start by adding 6 grams of Oxidizer for low volume (5 to 7 plunges per week) or 12 grams (1 full cap) for high volume (7+ plunges per week).
- Wait 15 minutes.
- Immerse Test Strip to a depth of 6" for 2 seconds. Remove and shake once to remove excess water. Wait 10 seconds and compare to color chart on back of bottle. If Sanitizer shows below the "OK" range, add 2 grams of chlorine.. Wait 15 minutes and test again. Repeat test and add more Sanitizer if necessary.
- If Alkalinity, pH, or Calcium are outside of desired range, balancers can be purchased. Of these, pH is most important to have in the right range.

STEP 2) CHECK EXTERNAL WATER STRAINER

- Turn off Chiller, and close Tub Valves by turning handle perpendicular to the valve body.
- Remove the bottom red "Inlet" Chiller Hose from the Chiller. Remove Water Strainer Cover by twisting counterclockwise and check Inner Water Strainer for debris; remove any foreign materials present. Use brillo pad or rough sponge if necessary. Check the Strainer O-ring at the base of the threads is present and free from damage before reinstalling Water Strainer Cover.

STEP 3) CHECK WATER FILTER

- For optimal filter performance, replace on a monthly basis. To access the Water Filter, turn the Lower Water Filter Housing to the left if facing the back of the Chiller. When changing the filter, empty water from Lower Water Filter Housing fully and refill up to the top with fresh water.
- Ensure the Filter Housing O-ring in the Upper Water Filter Housing (white part) is present and free from damage before reinstalling filter housing.
- Be sure to open the Tub Valves before turning the Chiller back on, or damage will occur!

RECOMMENDED ROUTINE MAINTENANCE

To ensure the longevity of your Coldture Chiller, it is recommended to perform maintenance on your Chiller on a regular basis. This maintenance protocol will help ensure that

the Chiller functions as expected and that the water quality of the Tub is kept clean. The steps below should be performed every three months.

TUB

1. Disconnect the Tub from the Chiller.
2. Drain all water from the Tub and Chiller Hoses.
3. Using mild soap and water, wash down the inside and outside of the Tub using a washcloth or soft sponge. Place the Chiller Hoses inside the Tub and run soapy water through them.
4. Rinse Tub and Chiller Hoses off with clean water.
5. Allow Tub and Chiller Hoses to air dry completely; preferably in direct sunlight.
6. Refill with water and perform initial Sanitizer protocol to sanitize the new water.

CHILLER

Descaling

1. Disconnect the Chiller Hoses from the Tub. Ensure Tub Valve Fittings are in the closed (perpendicular) position if the Tub still contains water.
2. Place both ends of the Chiller Hoses into a 5 gallon bucket or similar container. Fill with distilled white vinegar (cleaning vinegar) and water at a 1:4 ratio.
3. Turn on the Chiller and run in heating mode at 40°C./ 104F. Allow the Chiller to circulate water for 30 minutes.
4. Turn off the Chiller and empty the bucket of water. Refill with clean water. Place Chiller Hoses back in the bucket and run the Chiller for another 30 minutes. The descaling process is now complete.

HOUSING MAINTENANCE

1. With a soft cloth, wipe down the exterior of the Chiller with mild soap and water.
2. Wipe off all soap residue with damp cloth.
3. With Chiller Off, inspect fan and remove any debris that may be on or around the fan shroud.

WATER CIRCULATION TROUBLESHOOTING**Step 1)**

The code o1.x or o2.x is shown on the display at startup and when Chiller is priming with water. This screen is normal when establishing water circulation which can take up to 2-3 minutes, especially if the Chiller and/or Chiller Hoses were recently drained of water.

If after 5 minutes the machine has still not established water circulation, please check each of the following. The Chiller can be tested in between each step:

- A. Ensure that the Tub Fitting Valves are in the open (parallel) position and hoses are connected without leaks.
- B. Check that the Water Filter and Inner Water Strainer are clean and clear of debris. You can find instructions to replace and clean these parts on our Maintenance Page. It is a good idea to proactively replace the Water Filter even if it looks clean as minerals can block the filter but may not show discoloration.
- C. Check the Hose O-Rings on each end of the Hose Connection Fittings. They should be fully seated at the bottom of the threaded fitting and when attached, the connection should only be tightened until a little resistance is felt and hose no longer wiggles at connection point. Do not use tools to tighten.'
- D. Remove the Lower Water Filter Housing and ensure that the Filter Housing
- E. Ring in the Upper Water Filter Housing (white part) is present and not damaged. If you have a purple tinted Lower Water Filter Housing, check that the lower O-ring is present as well. When reinstalling the Lower Water Filter Housing, fill with water to the top and tighten only until a little resistance is felt. Do not over tighten or it will deform the gasket and potentially damage the O-Rings.
- F. Ensure the Strainer O-Ring on the External Water Strainer is present and not damaged. Replace if necessary from the spare parts kit. The Water Strainer Cover should be hand tightened until it stops.

If the steps above do not resolve the issue, please move on to the next step.

Step 2)**Air Trapped in Unit**

If you have recently taken a Chiller Hose off of the Chiller or Tub (For example, to clean the Inner Water Strainer), it is possible that an air lock can be created within the Chiller. We will want to release this air lock in the system by loosening the Lower Water Filter Housing. Loosen the housing until it is completely off, fill up with water to the top, and reinstall.

If the steps above do not resolve the problem, please contact: support@coldture.com so that we can further assist you!

• HOSE CONNECTIONS LEAKING:

Check to ensure gasket is in place; Disconnect and reconnect Chiller Hose, ensuring snug hand tight connection; Replace Hose O-Ring with new one.

• CHILLER WILL NOT TURN ON:

Ensure Chiller is plugged into an active power source and ensure the Power Switch on the back of the Chiller is up in the “on” position. Press the orange “T” Test Button above the Power Switch. The Power Switch should flip to the down “off” position. Now flip the Power Switch back up to the “on” position. If this test does not cause the Power Switch to turn off, do not proceed, and contact support for assistance.

• WATER IS DRIPPING FROM CHILLER:

During heating mode, condensation may develop inside the Chiller in certain high humidity conditions. A small amount of water drainage from the Chiller is normal in this circumstance; Check Hose Connections are secure and that they are tight and have O-Rings in place; Check Water Filter Housing connection and that it is tight and has the Filter Housing O-Ring in place; Check Drain Plug Cap is in place and tight.

• WHEN TEMPERATURE SET POINT IS INCREASED, CHILLER DOES NOT STOP RUNNING:

If changing from a low set point to a higher one, or vice versa, the Chiller will switch from Cooling mode to Heating mode to reach the new set point. The Chiller will also cool or heat to a temperature just beyond the set point to ensure the Chiller does not cycle on and off excessively, and will restart automatically when the water temperature gets outside of the set range by a few degrees Fahrenheit.

• WATER HAS BECOME CLOUDY

Check filter element and replace if discolored; Add 60cc (2oz) of Oxidizer to water to break down organics and allow to run for 2 hours; Replace water if this fails.

• CANNOT CONNECT CHILLER TO WIFI

Ensure that the WiFi network you are trying to access is 2.4ghz. This product only works with a 2.4ghz wireless network. Some networks can be configured to provide both frequencies if they are dual-band; Ensure WiFi password is correct by testing with another device; Ensure Chiller is in-range of WiFi signal; Ensure device with Tuya Smart app has internet connection.

• ERROR CODE: E1/FL/FU

Too much air inside the water circulating loop.

Double check the Chiller Hoses, Hose Connectors, External Water Strainer, and Water Filter Housing to see if any connections are not properly made. Review Water Circulation Troubleshooting above for more detailed steps to resolve.

• ERROR CODE: E2/HH

Water temperature is too high.

Wait for the water temperature to cool down and then select “Mode” (second button) to cancel this error code.

• ERROR CODE: E3/FU

Water flow is low.

See Water Circulation Troubleshooting instructions above for detailed steps to resolve.

• ERROR CODE: E4/AA

Temperature sensor T4 failure
Contact Coldture Support.

• ERROR CODE: E5/PA

Temperature sensor T3 failure
Contact Coldture Support.

• ERROR CODE:CH2

Temperature sensor T2 failure
Contact Coldture Support.

Coldtuture warrants this product to be free from defects in workmanship and materials, under normal residential use and conditions, for a period of one (1) year from the original ship date. Coldtuture agrees, at its unfettered discretion, during the warranty period, to repair any defect in material or workmanship or to furnish a repaired or refurbished product of equal value in exchange without charge (cost of shipping and handling will be covered by Coldtuture so long as the warranty claim is deemed legitimate, as outlined in this paragraph above). Such repair or replacement is subject to verification of the defect or malfunction

and proof of purchase and Coldtuture retains the right to dismiss a warranty claim if foul play is suspected. For clarity, this warranty does not include: Any condition resulting from other than ordinary residential wear or any use for which the product was not intended, such as use in rental or contract trade or commercial use, any condition resulting from incorrect or inadequate maintenance or care, any condition resulting from modifications, damage resulting from misuse, abuse, negligence, accidents, dissatisfaction due to buyer's remorse, normal wear and tear, damages incurred during transportation, or failure to comply with all instructions and warnings.

THE COLDTUTURE SYSTEM USER MANUAL