

# TORONTO SE SPA

## Owner's Manual - 60Hz



**Electrical:** 240V/50A

**Weight:** 900 lbs (Dry), 3350 lbs (Filled)

**Water Capacity:** 1110 L

**Jet Count:** 44

**Seat Count:** 6

**Size:** 84" x 84" x 32"

**Pump(s):** 2 x 2 Speed 5 HP

**Heater(s):** 5.5 kW

**Filter(s):** 100sq ft Glacier Antimicrobial filter set (KA-10032)

# SAFETY INFORMATION

## NORTH AMERICA (60Hz)

### IMPORTANT SAFETY INSTRUCTIONS

When installing and using this electrical equipment be sure to follow these basic safety precautions:

- WARNING:** To reduce the risk of injury, do not permit children to use this product unless they are closely supervised at all times.
- DANGER:** Risk of accidental drowning. Extreme caution must be exercised to prevent unauthorised access by children. To avoid accidents, ensure that children cannot use this spa unless they are supervised at all times.
- DANGER:** Risk of injury. The suction fittings in this spa are sized to match specific water flow created by the pump. Should the need arise to replace the suction fitting or the pump, ensure that the flow rates are compatible. Never operate the spa if suction fittings are broken or missing. Never replace a suction fitting with one rated less than the flow rate marked on the original suction fitting.
- DANGER:** Risk of Electrical Shock. Install at least 5ft (1.5m) from all metal surfaces. As an alternative, spa may be installed within 5ft (1.5m) of metal surfaces if each metal surface is permanently connected (bonded) by a minimum ground wire.
- DANGER:** Risk of Electrical Shock. Do not permit any electrical appliance such as a light, telephone, radio, television, etc. within 5ft (1.5m) of a spa unless such appliances are installed and built-in by the manufacturer.
- ELECTRICAL SUPPLY:** The electrical supply for this product must include a suitably rated switch or circuit breaker to open all ungrounded supply conductors to comply with the national electrical standards. This disconnect must be readily accessible and visible to the spa occupant but installed at least 5ft (1.5m) from the spa water.
  - WARNING:** To reduce the risk of injury:
    - The water in the spa should never exceed 40°C (104°F). Water temperature between 38°C (100°F) and 40°C (104°) is considered safe for a healthy adult. Lower water temperatures are recommended for young children and when the spa use exceeds 10 minutes.
    - Since excessive water temperatures have a high potential for causing fetal damage during early months of pregnancy, pregnant women should limit spa water temperatures to 38°C (100°F)
    - Before entering a spa, the user should measure the water temperature with an accurate thermometer since the tolerance of water temperature regulating devices varies.
    - The use of alcohol, drugs, or medication before or during spa use may lead to unconsciousness with the possibility of drowning.
    - Obese persons and persons with a history of heart disease, low or high blood pressure, circulatory system problems, or diabetes should consult a physician before using a spa.
    - Persons using medication should consult a physician before using a spa since some medication may induce drowsiness while other medication may affect heart rate, blood pressure, and circulation.
- AUDIO/VIDEO EQUIPMENT WARNINGS (Optional equipment based on model)**
  - CAUTION:** Risk of Electrical Shock. Do not leave compartment door open.
  - CAUTION:** Risk of Electrical Shock. Replace components only with identical components.
  - WARNING:** Prevent Electrocution. Do not connect any auxiliary components (for example cable, additional speakers, headphones, additional audio/video components, etc.) to system.
  - CAUTION:** Risk of Electrical Shock. Do not service this product yourself as opening or removing audio covers may expose you to dangerous voltage or other risk of injury. Refer all servicing to qualified service personnel.
  - CAUTION:** Risk of Electrical Shock. When the power supply connections or power supply cord(s) are damaged; if water is entering the audio / video compartment or any electrical equipment compartment area; if the protective shields or barriers are showing signs of deterioration; or if there are signs of other potential damage to the unit, turn off the unit and refer the servicing to a qualified service personnel.
  - This unit should be subject to periodic routine maintenance (for example, once every 3 months) to make sure that the unit is operating properly.
  - CAUTION:** Do not operate audio video controls while inside the spa
  - Installation of the spa for other than a residential dwelling will result in voiding the manufacturer's warranty.
  - Do not bring any object into the spa that could damage the spa shell.
  - Never insert any object into any opening.
  - WARNING:** Do not sit on the spa cover or place objects on it.
  - Remove any water or debris that may collect on the spa cover.
  - WARNING:** Do not use the spa immediately after strenuous exercise.
  - If you feel pain or dizziness at any time while using the spa, discontinue use and contact a physician.
  - WARNING:** To reduce risk of injury it is especially important that persons with pre-existing health conditions or problems such as obesity, heart disease, high or low blood pressure, circulatory problems, pregnancy or diabetes consult their doctor before using the spa.
  - WARNING:** Observe reasonable time limits when using the spa. Long exposures at high temperatures can cause high body temperatures. Symptoms may include dizziness, nausea, fainting, drowsiness, and reduced awareness. These effects could possibly result in drowning.
  - WARNING:** The spa jets produce a stream of water with relatively high pressure. Prolonged exposure of localized area of the body may cause bruises to the skin.
  - IMPORTANT:** The included warning sign must be posted where all users of the spa can see and read it.
  - WARNING:** To avoid risk of drowning. The spa cover should be in place and properly latched when spa is not in use.
  - IMPORTANT:** Read and understand the warnings on the spa cover.
  - Proper water chemistry is necessary to maintain the water and prevent possible damage to spa components.



## WARNING

### REDUCE THE RISK OF ELECTROCUTION

- Never place an electric appliance within 5ft (1.5m) of spa.

### REDUCE THE RISK OF CHILDREN DROWNING

- Supervise children at all times.
- Attach and lock down spa cover after each use.

### REDUCE THE RISK OF OVERHEATING

- Check with a doctor before use if pregnant, diabetic, in poor health, or under medical care.
- Exit immediately if uncomfortable, dizzy, or sleepy. Spa heat can cause hyperthermia and unconsciousness.
- Spa heat in conjunction with alcohol, drugs, or medication can cause unconsciousness.

**WHEN PREGNANT;** soaking in hot water for long periods can lead to pregnancy concerns. Measure water temperature before entering.

- Do not enter spa if water is hotter than 100°F (38°C).
- Do not stay in spa for longer than 10 minutes.

# QUICKSTART GUIDE

## Register Warranty

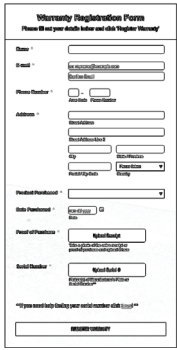

Warranty Registration Form  
Please fill out your details below and click "Register Warranty"

Name:

E-mail:

Phone Number:

Address:

City:

Province:

Postal Code:

Date Purchased:

Model Number:

Serial Number:

\*Please send only clearly legible and correct number data.

Make sure to register your warranty at [canadianspacompany.com/warranty](http://canadianspacompany.com/warranty)

## Electrical

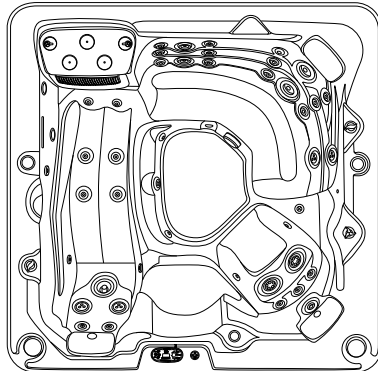

We suggest you hire a licensed electrician to install any electrical work needed to operate your spa

## Fill Hot Tub

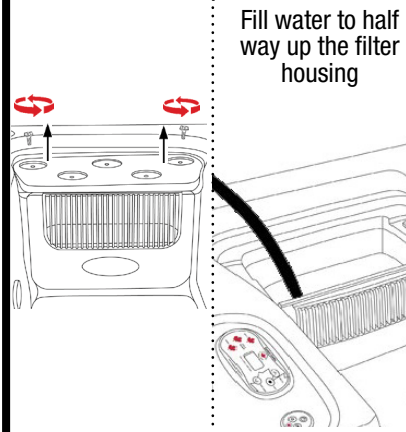

Remove screws and fill the hot tub with water through the filter housing

## Insert Filters

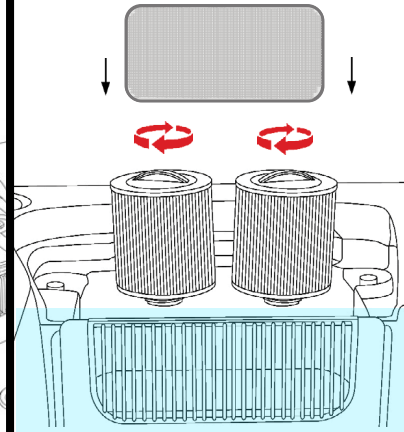

Once the hot tub is filled, install your new Glacier Antimicrobial Filter Set and place the prefilter on top

## Power On

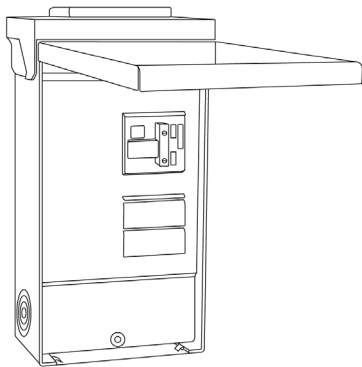

Turn on your breaker to start your hot tub

## Add Chemicals



Follow our Spa Chemical Startup Guide instructions to balance your water

## Wait for Water to Heat

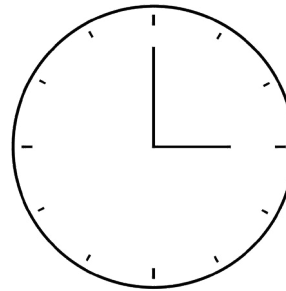

The water will take 4-6 hours for 240V to reach full temperature

## Enjoy

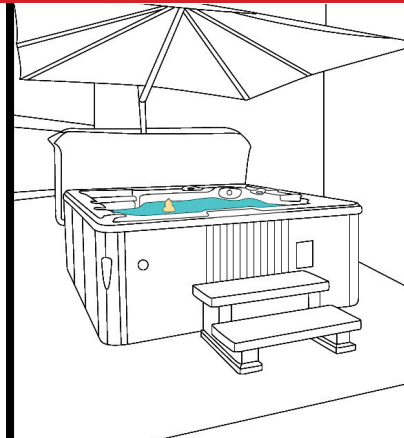

Sit back and relax in your brand new spa!



FOR MORE HELP GUIDES VISIT US AT:  
[support.canadianspacompany.com](http://support.canadianspacompany.com)  
1-877-909-7727

# INSTALLATION

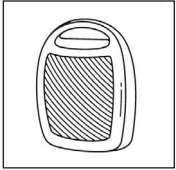

## WINTER INSTALL

Do **NOT** proceed with installing your hot tub in freezing temperatures! In colder temperatures please make sure to place a space heater inside the cabinet immediately after delivery for 24 to 48 hours before installation to prevent startup issues.



## LICENSED ELECTRICIAN

A licensed electrician can install the wiring by drilling a hole into any panel and terminating the connection at the control pack.

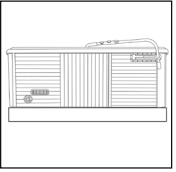

## PROPER SPA BASE

All hot tubs must be placed on a proper base that is reinforced for the weight of the hot tub, water and people who may be within the hot tub at any given time. This base must be flat and come in contact with the entire base of the spa. We recommend a base that can support at least 150 pounds per square foot such as a 4-6 inches poured concrete pad.

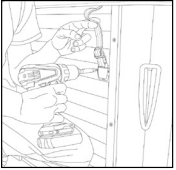

## ATTACH SPA COVER

Lay your cover onto your hot tub then line up locking straps and secure with mounting hardware. Use the lock and key clasps to secure your cover in place. Always lock your cover when the hot tub is unattended. Do **NOT** walk or sit on the spa cover.

## GFCI TROUBLESHOOTING (240V ONLY)

Keep in mind that the majority of 240V GFCI tripping problems can attribute to incorrect wiring.  
GFCI troubleshooting usually finds the problem

**REFER TO DIAGRAM ON NEXT PAGE**

### IF CORRECT WIRING IS VERIFIED

- **IMPORTANT: All electrical installation work must be performed by a qualified electrician and must conform to local codes**
- Check to see if the proper sized GFCI is installed.
- Be sure the GFCI is rated for more amperage than the system will draw.
- For a 240V system, the GFCI must include a load neutral out.
- **NOTE: If the white load neutral wire is routed from the GFCI neutral bar directly to TB1 in the system box, then the GFCI will trip when a 120V device is activated. This is the most common reason if your hot tub is tripping immediately.**
- If the wiring is correct and the GFCI will not reset, then unplug the heater and try to reset the GFCI.
- If the GFCI trips again, then unplug the pump and reset the GFCI. If the GFCI continues to trip, then do the same procedure for the ozone generator.
- If the GFCI stops tripping after you unplugged one of the spa's components, turn off the power to the spa then plug in each component except the one that tripped the GFCI.
- Power up the system. If the GFCI no longer trips, then you have correctly identified the problem.
- Repair or replace the component as instructed by the spa manufacturer.
- If everything looks to be in perfect working order, then the GFCI may be defective.

**WARNING: THE OWNER SHOULD TEST AND RESET THE GFCI ON A REGULAR BASIS TO VERIFY ITS FUNCTION**



FOR MORE HELP GUIDES VISIT US AT:  
[support.canadianspaccompany.com](http://support.canadianspaccompany.com)  
1-877-909-7727

## House Breaker Box

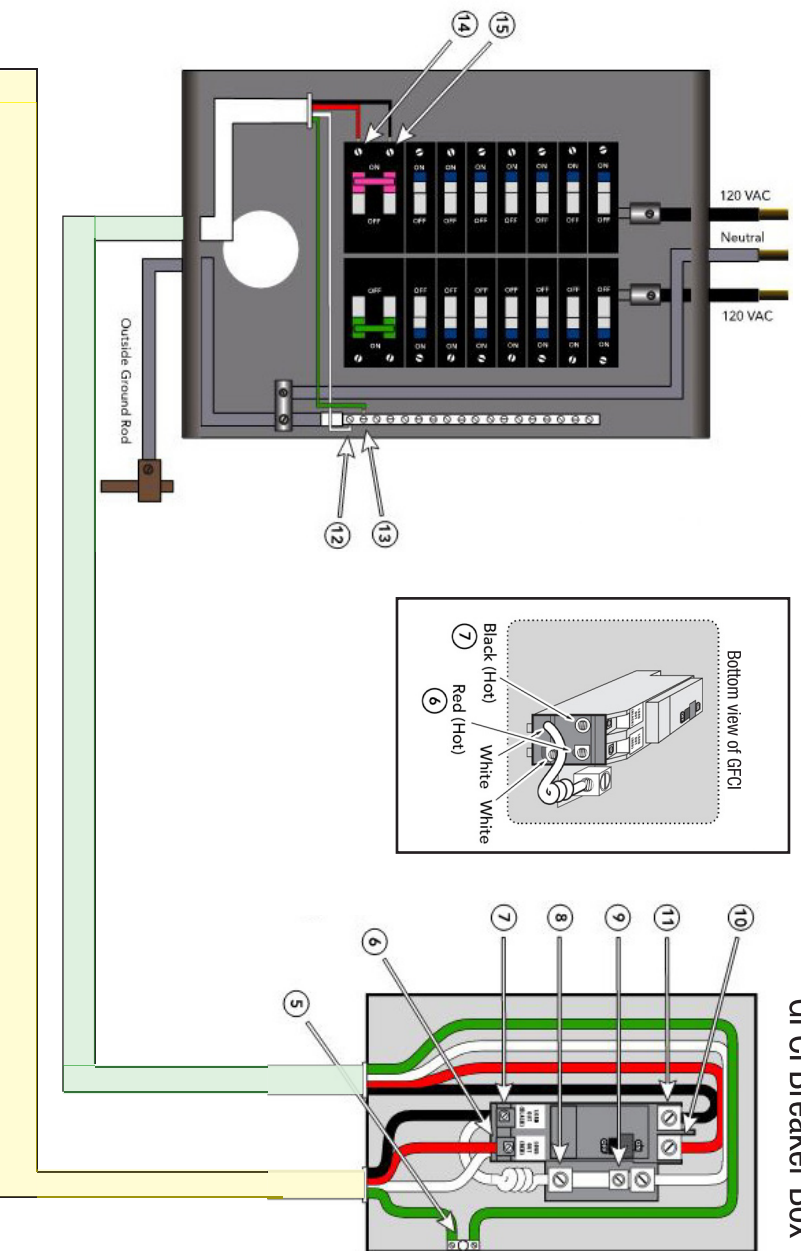

## GFCI Breaker Box

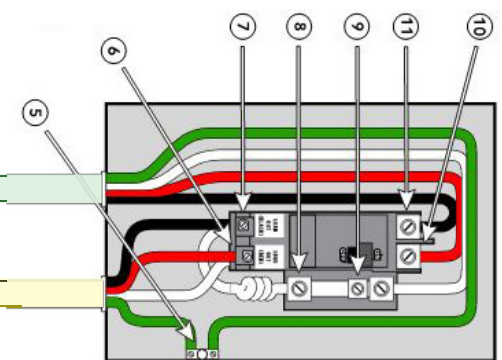

Correct Voltage	When Probes Are Placed Across
0v	[3 - 4] [5 - 8] [5 - 9] [12 - 13]
108V - 132V	[1 - 3] [5 - 6] [5 - 10] [12 - 14] [13 - 14] [2 - 3] [5 - 7] [5 - 11] [12 - 15] [13 - 15]
216V - 264V	[1 - 2] [6 - 7] [10 - 11] [14 - 15]

# 240V GFCI Electrical Installation

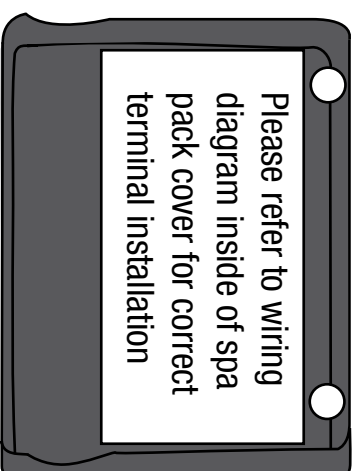
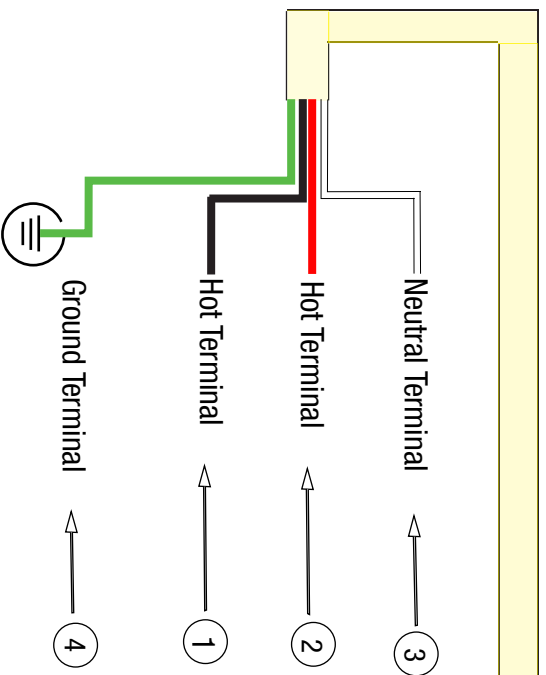

# FEATURE FUNCTIONS

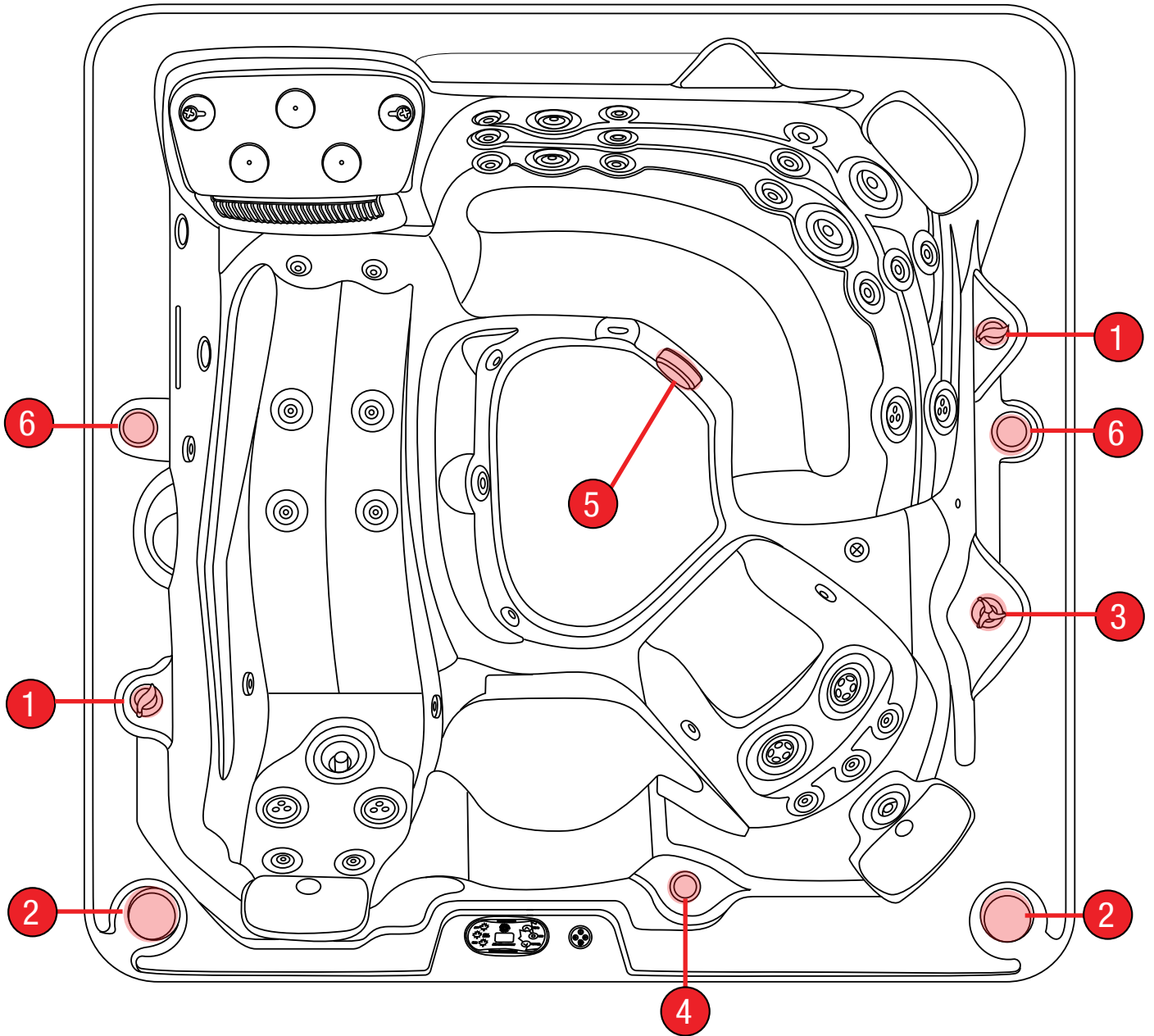

**1** Air Control Valve

**2** Speaker

**3** Waterfall Control Valve

**4** Aromatherapy

**5** Suction Intake

**6** LED Cup Holder

## WATERFALL CONTROL VALVE



The waterfall control valve controls the amount of water flowing out through the waterfalls.

## AROMATHERAPY



Place the aromatherapy beads inside the canister to mix in with the air valves to release scented bubbles throughout the tub.

## JETS



The massage is the best part! Our jets offer **massage** or **directional** styles! The directional style can target specific muscles for a precise massage where the massage style jet offers a circular and gentle massage. All jets are **interchangeable** and **adjustable**! Swap them around and turn them off/on to customize your spa to your satisfaction!

## SUCTION INTAKE

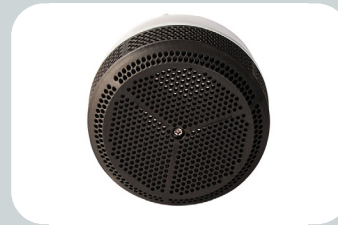

This suction intake brings in water from the bottom of the tub for maximum efficiency. Please make sure these suction intakes are always clear!

## AIR CONTROL VALVE



Open and close this valve to inject air bubbles into the jet stream. The warm air from inside the cabinet is mixed with the water to help maximize the hydrotherapy experience!



FOR MORE HELP GUIDES VISIT US AT:  
[support.canadianspacompany.com](http://support.canadianspacompany.com)  
1-877-909-7727

5\*

# EQUIPMENT LOCATIONS

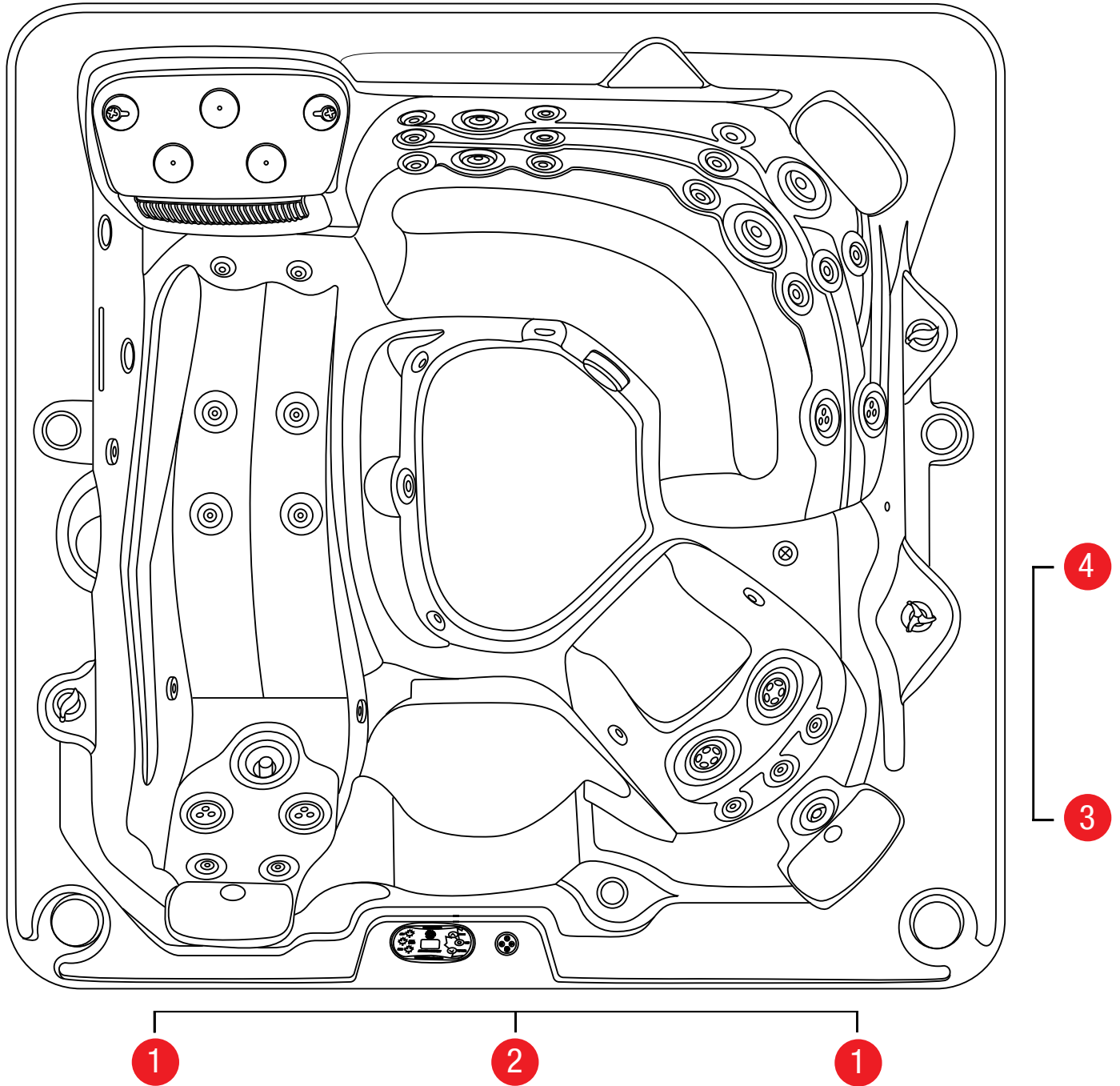

1 Pump(s)

2 Control Pack & Heater

3 Drain

4 Glacier AO<sub>3</sub>P  
*(Purchase separately)*

5 Electrical\*



## PUMPS



With up to 400% more hydro massage configurations, Canadian Spa Company's multi-speed pumps give you endless combinations of jet speeds and power. From relaxation to aquatic exercise to marathon training, our pumps can really do it all.

## GLACIER A<sub>3</sub>P *(purchase separately)*

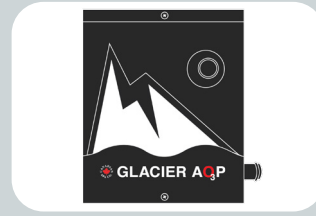

Free of pollution, glaciers contain the world's most pristine water. Our Glacier A<sub>3</sub>P system sterilizes up to 99.9% of bacteria in your hot tub, reducing chemical usage by up to 80% and leaving your water crystal clear!

## CONTROL PACK & HEATER



Our control pack software design incorporates patented technology using a microprocessor to intelligently monitor the hot tub water temperature and detect a runaway pump or stuck relays.

## ELECTRICAL\*

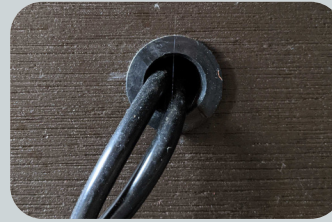

Plug and play models have designated electrical panels so please keep this in mind when placing your tub in its location. All 240V hot tubs allow you to choose which panel you would like to drill a hole into for your wiring to pass through.

## DRAIN



Twist and pull out the drain valve to access the built drain and attach your garden hose for better convenience. We recommend that you change your water seasonally.

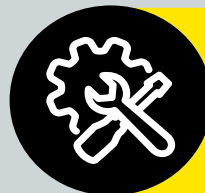

FOR MORE HELP GUIDES VISIT US AT:  
[support.canadianspacompany.com](http://support.canadianspacompany.com)  
1-877-909-7727

# CONTROL CENTRE GUIDE

## YOUR CONTROL CENTRE



\*Only on multi-pump spas

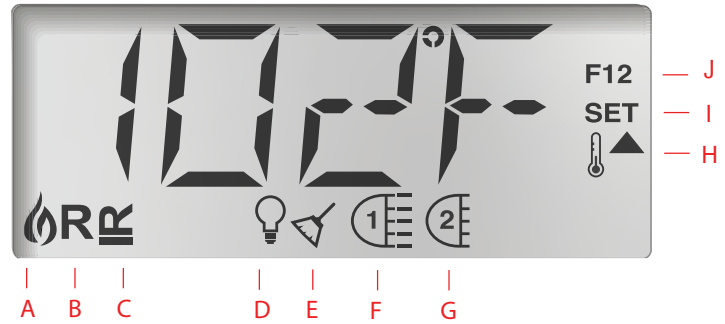

- A - Heat:** Indicates that the heater is on
- B - Ready Mode:** Set temperature will be maintained at all times (Recommended for Winter months)
- C - Rest Mode:** Heater will only run during filtration cycles (Recommended for Summer months)
- D - Light:** Multiple colour choices for your custom experience
- E - Cleanup Cycle:** Pump will run 30 min after spa use to filter and clean spa for 30 min
- F - Jets 1:** Pump 1 is on *Note: longer lines for high speed*
- G - Jets 2:** Pump 2 is on *Note: short lines for low speed*
- H - Temperature Range:** Temperature can be set between 80°F and 104°F
- I - SET:** Appears when changing settings
- J - Filter Cycle:** Indicates spa is running the filtration cycle

## START UP SEQUENCE

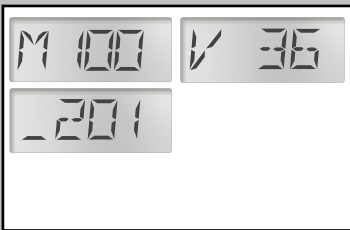

When power is applied to the spa, the first messages will be the version number of the system

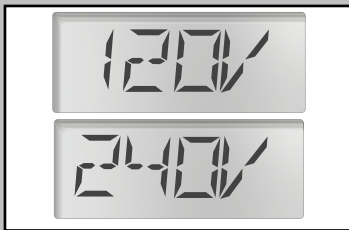

Make sure the voltage shown on your screen matches the electrical voltage of the hot tub (120V **OR** 240V)

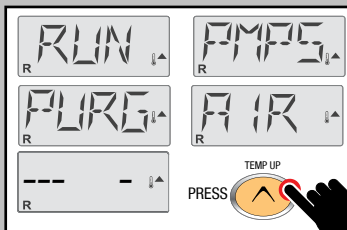

Spa will attempt to “Prime” itself, press “TEMP UP” to bypass

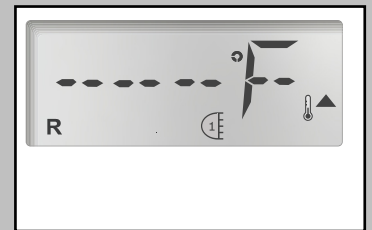

Pump 1 will then run on low speed to read current temperature. It will then start to heat up to the set temperature.

**Note:** TOO COLD message may occur if the initial water is too cold. Pump will continue to run until temperature reaches 45°F at which point the heater will turn on

## SETTING THE TEMPERATURE



Pressing the “TEMP UP” button or the “TEMP DOWN” button will cause the current set temperature to flash



Press the “TEMP UP” or “TEMP DOWN” button to set desired temperature while the numbers are flashing



When the flashing stops, the temperature is set and will show the current temperature of the water

**Note:** Jets 1 low speed will continue to run until the set temp is reached

## TURN ON THE LED LIGHTS



Press "LIGHT" button to activate lights



Press "LIGHT" button repeatedly until desired light setting is active

## TURN ON THE PUMPS

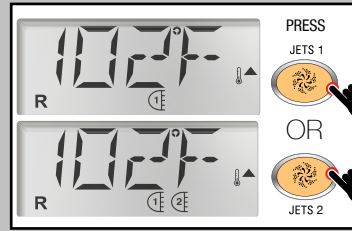

Press "JETS 1" button for pump 1 low speed to turn on. Press "JETS 2" button to activate pump 2 (if available)

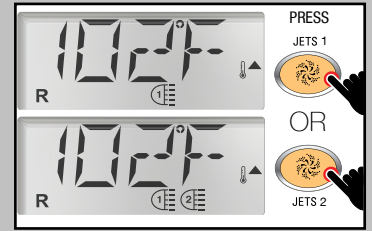



Press "JETS 1" button or "JETS 2" button a second time for high speed (if available)

## CHANGE THE SPA HEATING MODE (READY/REST)

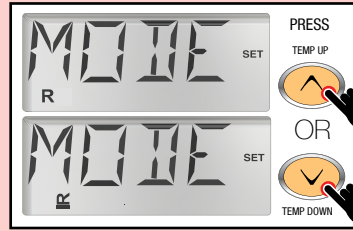

Press the "MENU" button until your screen displays MODE



Press the "TEMP UP" or "TEMP DOWN" button to select Ready R or Rest Mode  then press "MENU" again to complete action

**Note: It is recommended to leave the spa in ready mode**

## FLIP/INVERT THE DISPLAY



Press "MENU" button until your screen flashes FLIP

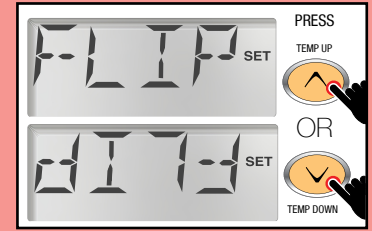

Press "TEMP UP" or "TEMP DOWN" button to set which orientation you would like for the screen to display. Press "MENU" again to complete action

## SET THE FILTER DURATION (IN HOURS)

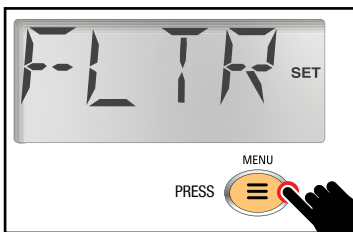

Press "MENU" button until your screen flashes FLTR

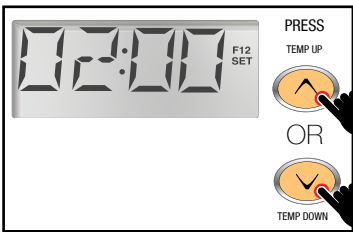

Press "TEMP UP" or "TEMP DOWN" button to set the number of hours you would like your filtration cycle to run every 12 hours. Press "MENU" again to complete action.

**Note: 2:00 means the spa would filter for a total of 4 hours per day (recommended)**

**For PH, FLTR etc. reminders, press either temperature button to bypass**

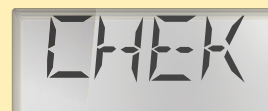

# SPA CHEMICAL STARTUP GUIDE

## YOUR STARTER KIT

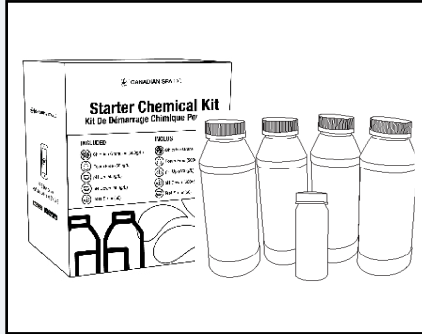

### Kit Includes

Chlorine Granules, Alkalinity Booster, pH Up, pH Down, Test Strips

## USING YOUR CHEMICALS

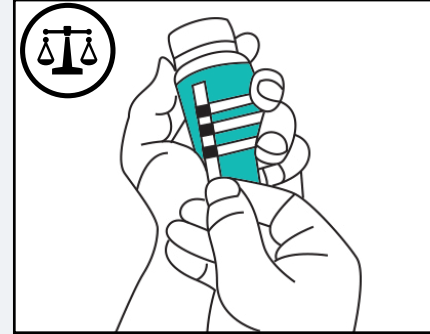

### Test Water

Balance in the following order:  
*Alkalinity, pH, Chlorine*

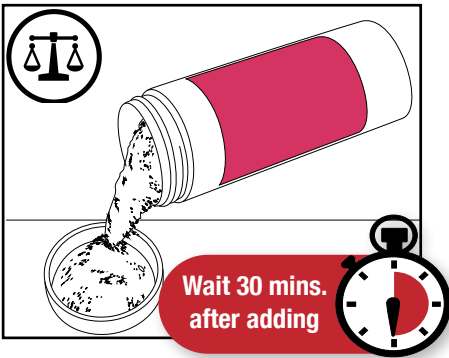

### Alkalinity Booster

Adjust alkalinity level to 80 -150 ppm  
*(use pH Down to reduce)*  
*(see bottle for directions)*

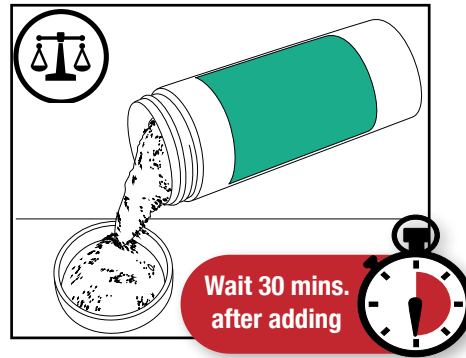

### pH Up / pH Down

Adjust pH level to 7.2 -7.6  
*(see bottle for directions)*

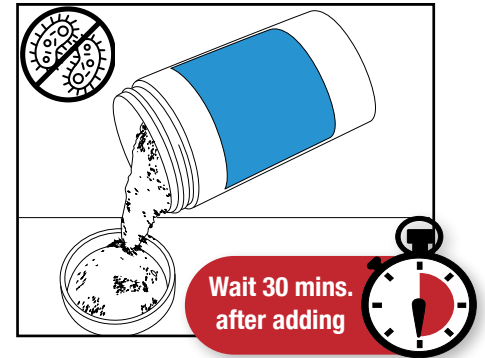

### Chlorine Granules

Add 15g per 1000L

## ENJOY!



# MAINTENANCE SCHEDULE

## PROCEDURE

EACH USE      WEEKLY      3-4 MONTHS      YEARLY

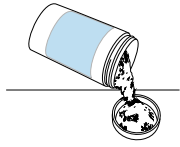

**SANITIZE**  
Replenish sanitizer levels with chlorine



**BALANCE**  
Balance your water according to Test Strip readings

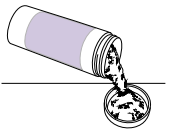

**SPA SHOCK**  
Oxidize your water to allow optimize the power of your sanitizer



**SCALE CONTROL**  
Protect against hard water and metals which can leave a buildup or residue

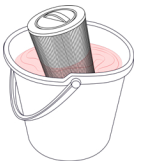

**FILTER FREE**  
Soak filter overnight and rinse to clean your filters



**SPA BALL**  
Replace your Spa Ball once it begins to sink below the surface of your water

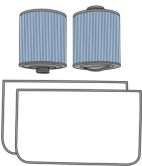

**REPLACE FILTER**  
According to replacement schedule



**SPA FLUSH**  
Add before draining spa water

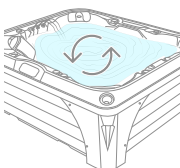

**CHANGE WATER**  
Drain and refill your water



**CHECK UV-C BULB** *(purchased separately)*  
Ensure LED is on during filter cycle



# LIMITED WARRANTY

## ACRYLIC SPAS

**Structural Warranty:** Canadian Spa Co. warrants structure of the spa shell against water loss due to structural failure for a period of **ten (10) years** from the date of purchase by the original owner. If in Canadian Spa Co. opinion, structure proves to be defective, Canadian Spa Co. will repair or, at its discretion, replace the defective structure without charge to the customer.

**Surface Warranty:** Canadian Spa Co. warrants the acrylic finish against defects in material and workmanship and specifically against blistering, cracking or delamination for the period of **two (2) years** from the original purchase date to the original purchaser. If, in Canadian Spa Co. opinion, the surface proves to be defective during this period, Canadian Spa Co. will repair or, at its option, replace the defective spa shell without charge to the customer.

**Equipment/Plumbing Warranty:** Canadian Spa Co. warrants the functional equipment and plumbing of the spa remain free from defects in material and workmanship for a period of **two (2) years** from the date of purchase by the original purchaser.

**Extent of Warranty:** This Limited Warranty applies to spas manufactured after **March 1st, 2021** and sold by authorized Canadian Spa Co. dealers to residential retail customers. This Limited Warranty is given only to the first retail purchaser and terminates upon transfer of ownership. No warranty is provided on any dealer installed accessories. Cost of installation, removal and/or shipping of the spa is not covered by this Limited Warranty. In the event Canadian Spa Co. deems necessary the removal of the spa to a place of repair or that the spa must be replaced, any and all costs of the spa removal and replacement; landscaping, decking, fencing and/or structure removal, alteration and/or replacement; or other costs of providing access to the spa will be for the purchaser. This Warranty applies only to spas in single family, residential installations. This Limited Warranty becomes void if the spa is placed in commercial application.

\*\*Floor models purchased from an authorized retailer come with a **two (2) year** parts replacement warranty only\*\*

## TERMS, CONDITIONS AND LIMITATIONS

Any defect or damage caused by installation, alteration or repair by anyone who is not an employee of Canadian Spa Co. or authorized service technician is not covered by the Warranty. This Warranty becomes void if the spa has been subjected to misuse, abuse, alteration or attempted alteration, repairs or attempted repairs by anyone other than an authorized Canadian Spa Co. service technician. Improper installation, improper water chemistry, improper maintenance, acts of god, or damage caused beyond the control of Canadian Spa Co. is not covered. Misuse and abuse shall include any operation of the spa other than as directed in the Canadian Spa Co. Manual.

Examples of misuse and abuse include, without limitation:

- Damage of the spa surface caused by leaving the spa uncovered while the spa is empty of water or due to covering the spa with plastic film of any kind.
- Damage to the spa surface caused by contact with unapproved cleaners or solvents.
- Damage caused by the operation of the spas at water temperatures outside of the range of 2 – 40 degrees Celsius.
- Damage caused by unapproved sanitizer such as calcium hypochlorite, tri-chlor type chlorine or any sanitizing chemical that may remain undissolved on the spa surface.
- Damage caused by failure to provide an even base support for the spa.
- Damage caused by freezing when new spa is not installed within a timely manner during below freezing temperatures.

**Warranty Performance:** In the event of a defect covered under the terms of this Limited Warranty, notify your authorised Canadian Spa Co dealer and create a ticket at support.canadianspacompany.com. A Canadian Spa Co. authorised service technician will repair the spa subject to the Terms and Conditions of this Limited Warranty. Use all reasonable means to protect the spa from further damage. Reasonable travel charges may be assessed by Canadian Spa Co. or its authorized service technician if the spa is located outside the nearest authorized service technician's service area. This warranty covers parts ONLY and does not include travel or on-site service charges unless a Service Contract has been purchased from Canadian Spa Co. Proper access must be provided to all sides of the spa at the cost of the customer in the extent of a warranty claim. Failure to provide access will nullify the warranty.

**Disclaimers:** Canadian Spa Company or any of its authorized service technicians shall not be held liable for injury, inconvenience, loss of use, chemical or water damage, transportation costs, contingent liabilities or any other incidental or consequential costs, expenses or damage as result of any deficiency or alleged deficiency of the spa. In no event shall Canadian Spa Co. be liable, for any reason or cause, in excess of the amount paid for the product. No other warranties, expressed or implied, are valid. No agent, dealer, distributor, Service Company or other party is authorized to change, modify or extend the terms of this Limited Warranty in any manner whatsoever. Warranty is only valid with a proof of purchase and manufacturers plate/serial number. Cosmetic damage or normal wear and tear is not covered by the warranty.

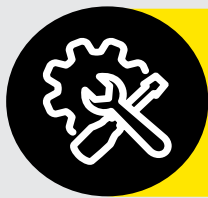

FOR MORE HELP GUIDES VISIT US AT:

[support.canadianspacompany.com](http://support.canadianspacompany.com)

1-877-909-7727

**North America Head Office:**  
Canadian Spa Company  
1283 Cornwall Rd,  
Oakville, ON L6J 7T5  
T: 1-877-909-7727  
[canadianspacompany.ca](http://canadianspacompany.ca)

**Canadian Spa Company LLC**  
6405 Inducon Drive West,  
Sanborn, NY 14132  
T: 1-844-879-7727  
[canadianspa.com](http://canadianspa.com)

**European Head Office:**  
Canadian Spa Company  
Canada House  
Salbrook Road  
Salfords, Redhill  
Surrey, RH1 5GL  
T: +44 1293 824094  
[canadianspacompany.co.uk](http://canadianspacompany.co.uk)

**France Office:**  
Canadian Spa Company sarl  
29 avenue de Grande  
Bretagne  
66000 Perpignan, France  
T: +33 9970 4448004  
[canadianspacompany.com](http://canadianspacompany.com)

**German Office:**  
Canadian Spa Company  
GmbH  
Hohenstaufenring 43 – 45  
50674 Köln, Germany  
TEL: + 49 22038064038  
[canadianspacompany.de](http://canadianspacompany.de)



Canadian Spa Company meets ISO 9001 Standards. When you purchase a hot tub from Canadian Spa Company the ISO 9001 certification assures world class excellence in manufacturing and customer service.



[canadianspacompany.com](http://canadianspacompany.com)

# TORONTO SE SPA



## le manuel du propriétaire - 60Hz



**Exigences Électriques:** 240V/50A

**Poids:** 900 lbs (Sec), 3350 lbs (Rempli)

**Capacité d'eau:** 1110 L

**Nombre de jets:** 48

**Nombre de place:** 6

**Taille:** 84" x 84" x 32"

**Pompe:** 2 x 2 vitesses 5 HP

**Chauffage:** 1 x 5.5 kW

**Filtre(s):** Filtres Glacier Antimicrobiens de  
100 pieds carrés(KA-10032)





# Guide de démarrage rapide du client

## Enregistrer la garantie

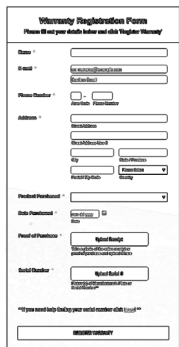

Warranty Registration Form  
Please fill out your details below and click Register Warranty

Name: \_\_\_\_\_  
E-mail: \_\_\_\_\_  
Phone Number: \_\_\_\_\_  
Address: \_\_\_\_\_  
City: \_\_\_\_\_  
Province: \_\_\_\_\_  
Postal Code: \_\_\_\_\_  
Product/Package: \_\_\_\_\_  
Date Purchased: \_\_\_\_\_  
Model Number: \_\_\_\_\_  
Serial Number: \_\_\_\_\_  
\*If you need help check your serial number club Log In\*\*

Assurez-vous d'inscrire votre garantie à [canadianspacompany.com/warranty](http://canadianspacompany.com/warranty)

## Électrique

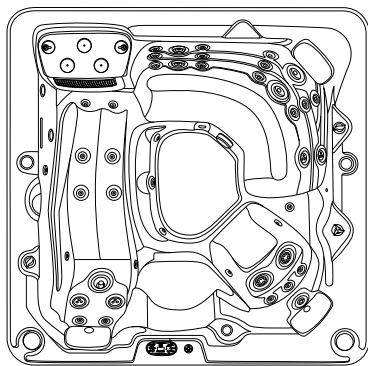

↑ Pack de contrôle ici ↑

Nous vous proposons d'embaucher un électricien agréé à installer votre spa

## Remplir le spa

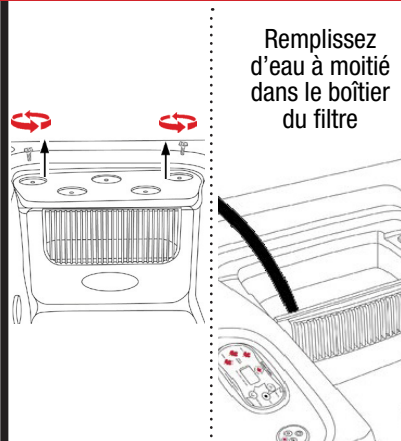

Retirez les vis et remplissez le spa avec de l'eau à travers le boîtier du filtre

## Insérer des filtres

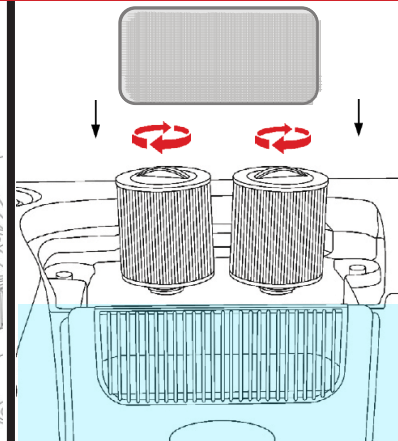

Une fois le spa rempli, installez vos nouveaux filtres Glacier et placez l'écran de pré-filtre sur le dessus

## Allumer

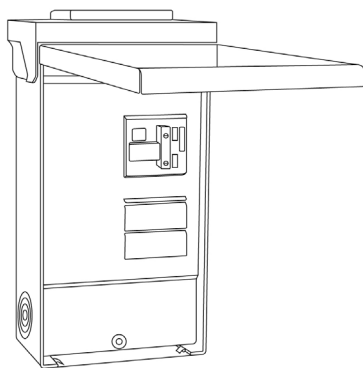

Branchez votre GFCI pour démarrer votre spa

## Ajouter des produits chimiques



Suivez notre guide de démarrage chimique pour équilibrer votre eau

## Attendez que l'eau chauffe

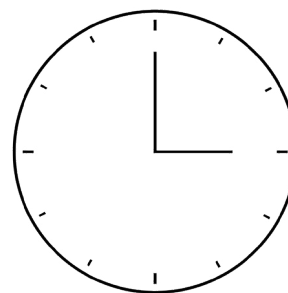

L'eau prendra 4-6 heures pour 240V à atteindre la température maximale

## Prendre plaisir

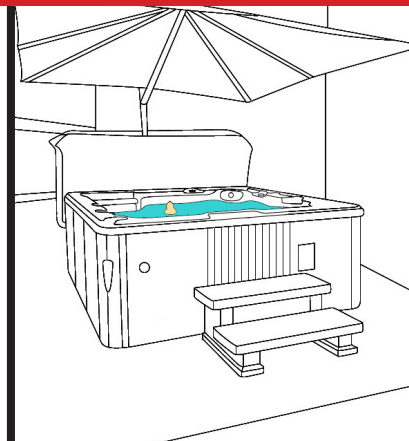

Asseyez-vous et détendez-vous votre nouveau spa!



POUR PLUS DE GUIDES D'AIDE, VISITEZ-NOUS À:  
[support.canadianspacompany.com](http://support.canadianspacompany.com)  
1-877-909-7727

# INSTALLATION

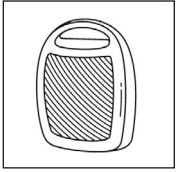

## INSTALLATION HIVERNALE

N'installez PAS votre spa dans des températures glaciales! Par temps froid, assurez-vous de placer un chauffant portable à l'intérieur de l'armoire immédiatement après la livraison pendant 24 à 48 heures avant l'installation pour éviter les problèmes de démarrage.



## ÉLECTRICIEN AGRÉÉ

Un électricien agréé peut installer le câblage en perçant un trou dans n'importe quel panneau et en terminant la connexion au pack de contrôle.

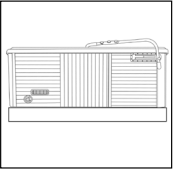

## BASE DE SPA APPROPRIÉE

Tous les spas doivent être placés sur une base appropriée qui est renforcée pour le poids du spa, de l'eau et des personnes qui peuvent être dans le spa à un moment donné. Cette base doit être plate et entrer en contact avec la base du spa. Nous recommandons une base pouvant supporter au moins 150 livres par pied carré, comme un 4-6 po en béton coulé.

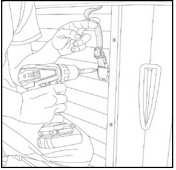

## FIXER LA COUVERTURE DU SPA

Posez votre couverture sur votre spa puis alignez les sangles de verrouillage et fixez-les avec le matériel de montage. Utilisez la serrure et la clé pour sécuriser votre couverture en place. Verrouillez toujours votre couvercle lorsque le spa est sans surveillance. Ne marchez PAS ou ne vous asseyez PAS sur la couverture du spa.

## DÉPANNAGE GFCI (240V SEULEMENT)

La majorité des problèmes de déclenchement du GFCI 240V peuvent être attribués à un câblage incorrect. Le dépannage GFCI trouve généralement le problème

### SE RÉFÉRER AUX DIAGRAMMES SUR LA PAGE SUIVANTE

#### SI LE CÂBLAGE EST VÉRIFIÉ

- **IMPORTANT: Tous les travaux d'installation électrique doivent être effectués par un électricien qualifié et doivent se conformer aux codes locaux**
- Vérifiez si le GFCI de taille appropriée est installé. (Reportez-vous au manuel du spa)
- Assurez-vous que le GFCI est conçu pour plus d'ampérage que le système n'en consommera.
- Pour un système 240V, le GFCI doit inclure une sortie neutre de charge.
- **REMARQUE: Si le fil neutre de charge blanc est acheminé de la barre neutre GFCI directement à TB1 dans le boîtier, le GFCI se déclenchera lorsqu'un appareil 120V est activé. C'est la raison la plus courante si votre spa trébuché immédiatement.**
- Si le câblage est correct et que le GFCI ne se réinitialise pas, débranchez le chauffant et essayez de réinitialiser le GFCI.
- Si le GFCI se déclenche à nouveau, débranchez la pompe et réinitialisez le GFCI. Si le GFCI continue de se déclencher, faites la même procédure pour le générateur d'ozone.
- Si le GFCI cesse de se déclencher après avoir débranché l'un des composants du spa, coupez l'alimentation du spa puis branchez chaque composant sauf celui qui a déclenché le GFCI.
- Démarrez le système. Si le GFCI ne se déclenche plus, c'est que vous avez correctement identifié le problème.
- Réparez ou remplacez le composant selon les instructions du fabricant du spa.
- Si tout semble être en parfait état de fonctionnement, le GFCI est peut-être défectueux.

**AVERTISSEMENT: LE PROPRIÉTAIRE DOIT TESTER ET RÉINITIALISER LE GFCI RÉGULIÈREMENT POUR VÉRIFIER SA FONCTION. SE RÉFÉRER AUX DIAGRAMMES SUR LA PAGE SUIVANTE**



POUR PLUS DE GUIDES D'AIDE, VISITEZ-NOUS À:  
support.canadianspacompany.com  
1-877-909-7727

# Boîte de disjoncteur

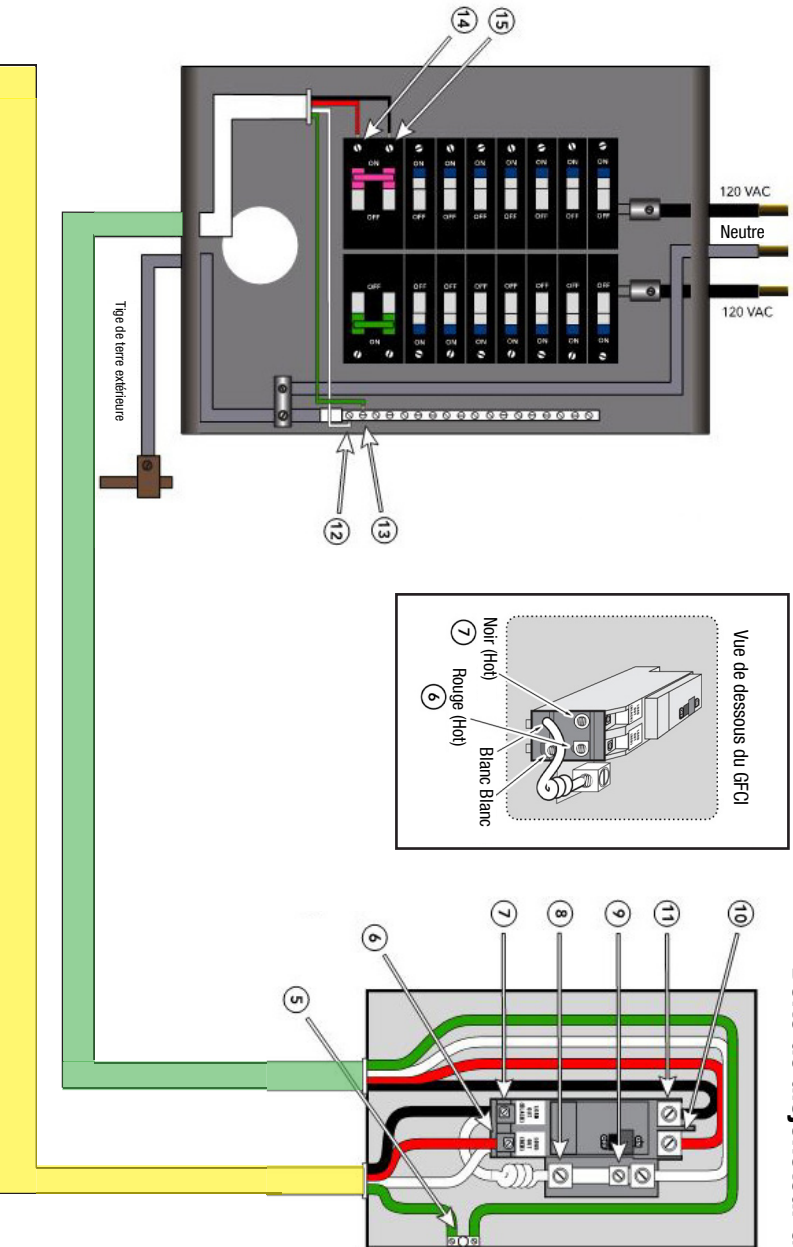

# Boîte de disjoncteur GFCI

Voltage Correcte	Lorsque les sondes sont placées en travers
0v	[3 - 4] [5 - 8] [5 - 9] [12 - 13]
108V - 132V	[1 - 3] [5 - 6] [5 - 10] [12 - 14] [13 - 14] [2 - 3] [5 - 7] [5 - 11] [12 - 15] [13 - 15]
216V - 264V	[1 - 2] [6 - 7] [10 - 11] [14 - 15]

# Installation électrique 240C GFCI

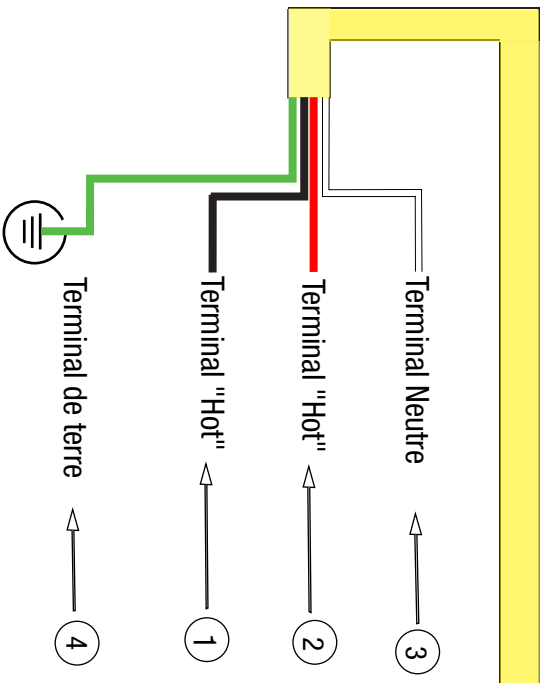

Veuillez vous référer au câblage diagramme à l'intérieur du spa couvercle du pack pour corriger installation du terminal

# FONCTIONS DES CARACTÉRISTIQUES

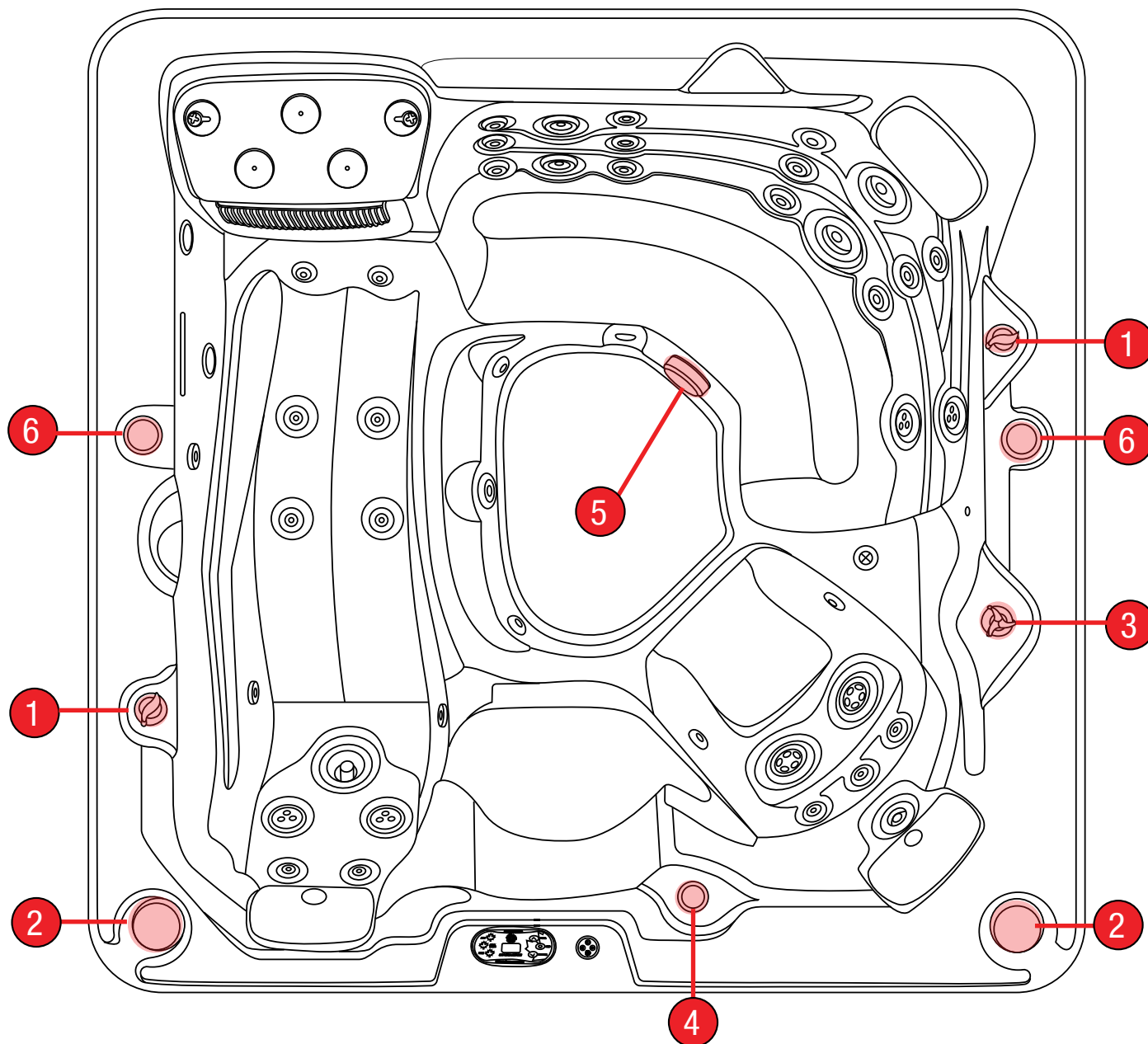

1 Valve de contrôle d'air

4 Aromathérapie

2 Haut-parleur

5 Soupape d'aspiration

3 Valve de contrôle de cascade

6 Porte-gobelet LED

## VANNE DE CONTRÔLE DE CASCADE



La valve de contrôle de la cascade contrôle la quantité d'eau qui s'écoulant à travers les chutes d'eau.

## AROMATHÉRAPIE



Placez les billes d'aromathérapie à l'intérieur de la cartouche pour mélanger avec les valves à air pour libérer des bulles parfumées dans le spa.

## JETS



Le massage est la meilleure partie! Nos jets proposent des massages ou styles directionnels! Le style directionnel peut cibler des muscles spécifiques pour un massage précis où le jet de style massage offre un massage circulaire et doux. Tous les jets sont interchangeables et réglables! Changez- les autour et les activer / désactiver pour personnaliser à votre satisfaction!

## SOUPAPE D'ASPIRATION

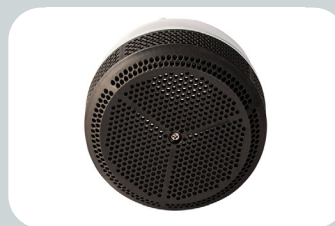

Amène l'eau du fond du spa pour une efficacité maximale. Veuillez vous assurer que ces aspirations sont toujours claires!

## VALVE DE CONTRÔLE D'AIR



Ouvrez et fermez cette valve pour injecter des bulles d'air dans le système. L'air chaud de l'intérieur du cabinet est mélangé à l'eau pour aider à maximiser l'expérience d'hydrothérapie!



POUR PLUS DE GUIDES D'AIDE, VISITEZ-NOUS À:  
[support.canadianspacompany.com](http://support.canadianspacompany.com)  
1-877-909-7727

5\*

# EMPLACEMENTS DES ÉQUIPEMENTS

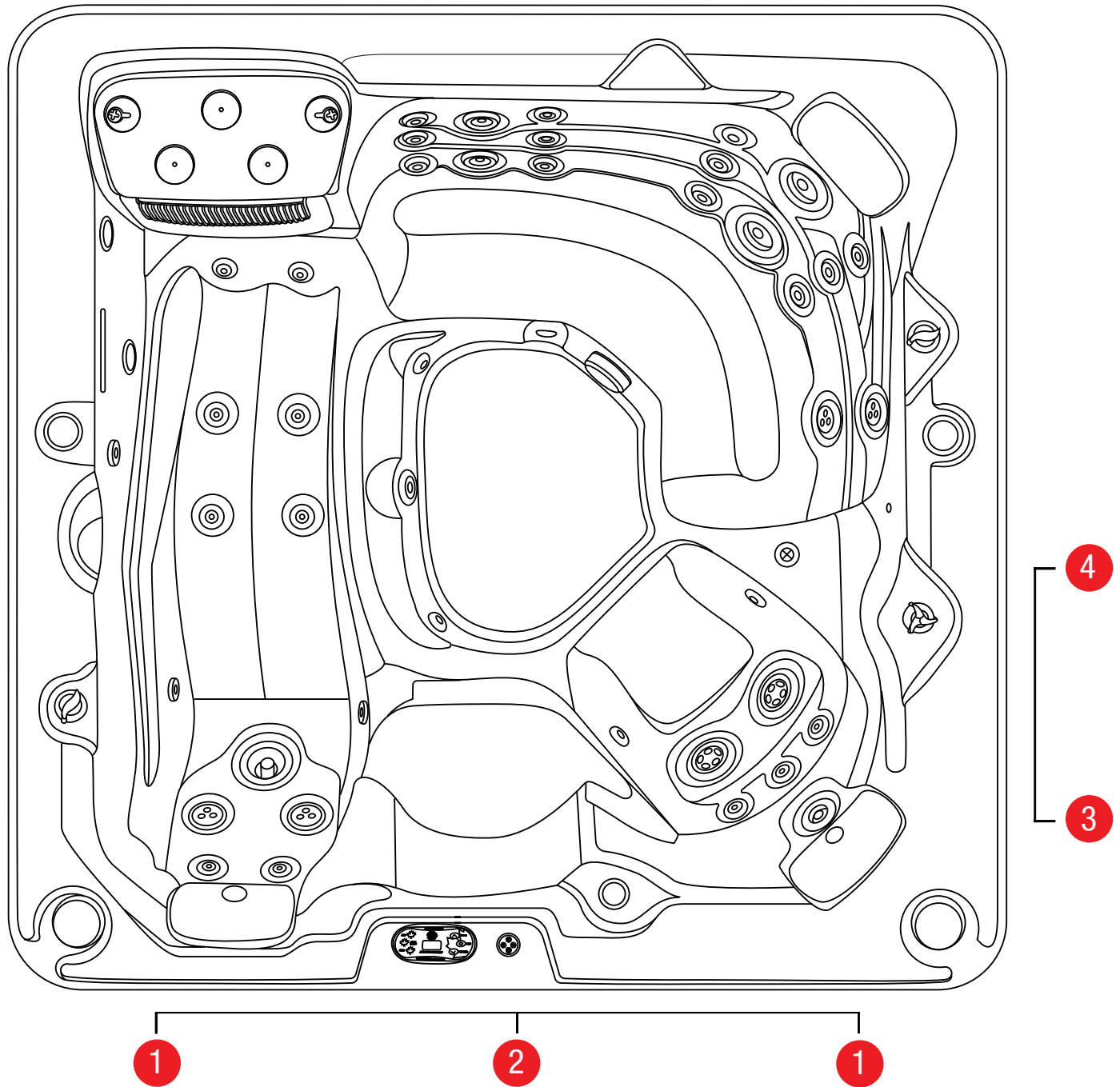

1 Pompe(s)

2 Pack de contrôle et chauffage

3 Drain

4 Glacier AO<sub>3</sub>P  
(Acheter séparément)

5 Électrique\*

## POMPE(S)



Avec jusqu'à 400% de configurations d'hydromassage en plus, les pompes multi-vitesses de Canadian Spa vous offrent une combinaison infinie de vitesses et de puissance des jets. De détente à l'exercice aquatique à l'entraînement d'un marathon, nos pompes peuvent vraiment tout faire.

## PACK DE CONTRÔLE ET CHAUFFAGE



Les modèles plug and play ont des panneaux électriques désignés donc s'il vous plaît garder cela à l'esprit lorsque vous placez votre spa dans son emplacement. Tous les spas 240V vous permettent de choisir le panneau dans lequel vous souhaitez créer un tout pour votre câblage pour passer à travers.

## DRAIN



Tournez et retirez le robinet de vidange pour accéder le drain et fixez votre tuyau d'arrosage. Nous vous recommandons de changer votre eau de façon saisonnière

## GLACIER AO<sub>3</sub>P (Acheter séparément)

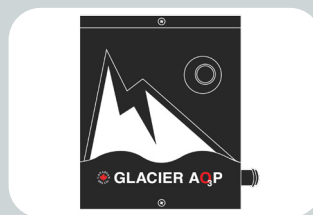

Exempts de pollution, les glaciers contiennent l'eau la plus pure du monde. Notre système Glacier AO<sub>3</sub>P stérilise jusqu'à 99,9% des bactéries dans votre spa, réduisant l'utilisation de produits chimiques jusqu'à 80% et laissant votre eau limpide!

## ÉLECTRIQUE\*



La conception de notre logiciel de pack de contrôle intègre des technologies brevetées utilisant un microprocesseur pour intelligemment surveiller la température de l'eau du spa et détecter une pompe qui s'emballe ou relais bloqués.



POUR PLUS DE GUIDES D'AIDE, VISITEZ-NOUS À:  
[support.canadianspacompany.com](http://support.canadianspacompany.com)  
1-877-909-7727

# Guide du centre de contrôle

## Votre centre de contrôle TP500S

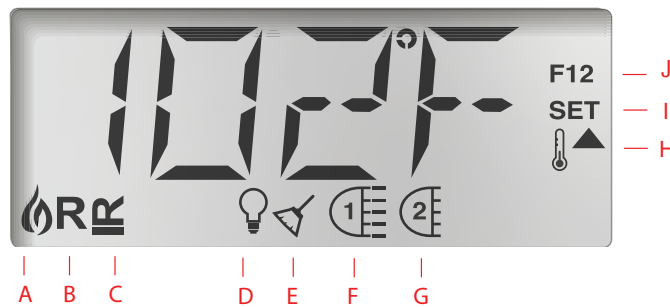

\*Seulement pour les spas multi-pompes

- A - Chauffage:** Indique que le chauffage est allumé
- B - Mode prêt:** La température réglée sera maintenue à tout moment (recommandé pour les mois d'hiver)
- C - Mode repos:** Le chauffage ne fonctionnera que pendant les cycles de filtration (recommandé pour les mois d'été)
- D - Lumière:** 12 choix de couleurs pour votre expérience personnalisée
- E - Cycle de nettoyage:** La pompe fonctionnera 30 minutes après l'utilisation du spa pour filtrer et nettoyer le spa
- F - Jets 1:** La pompe 1 est en marche  
Note: Lignes plus longues pour haute vitesse
- G - Jets 2:** La pompe 2 est en marche  
Note: Lignes plus courtes pour basse vitesse
- H - Température:** La température peut être réglée entre 80°F et 104°F
- I - SET:** apparaît lors de la modification des paramètres
- J - Cycle de filtration:** Indique que le spa exécute le cycle de filtration

## Séquence de démarrage



Lorsque l'alimentation est appliquée au spa, les premiers messages seront le numéro de version du système



Lorsque l'alimentation est appliquée au spa, les premiers messages seront le numéro de version du système. (120V **OU** 240V)

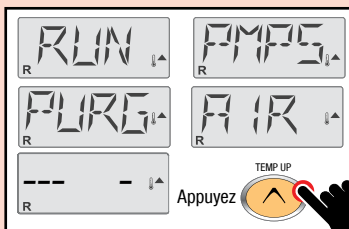

Le spa tentera de "s'amorcer" lui-même, appuyez sur "TEMP UP" pour contourner

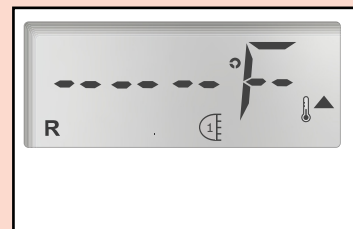

Le spa fonctionnera alors à basse vitesse jusqu'à la température actuelle prête. Il commencera alors à chauffer jusqu'à la température réglée

**Remarque:** un message "TOO COLD" peut apparaître si l'eau initiale est trop froide. La pompe continuera de fonctionner jusqu'à ce que la température atteigne 45°F, point auquel que le chauffant s'allumera

## Réglage de la température



Appuyer sur le bouton "TEMP UP" ou le bouton "TEMP DOWN" fera clignoter la température actuellement réglée

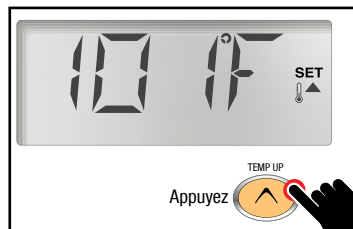

Appuyez sur le bouton "TEMP UP" ou "TEMP DOWN" pour régler la température souhaitée pendant que les chiffres clignotent



Lorsque le clignotement s'arrête, la température est réglée et affiche la température actuelle de l'eau

**Remarque:** Jets 1 à basse vitesse continuera de fonctionner jusqu'à ce que la température définie soit atteinte



# Guide du centre de contrôle

## Allumez les lumières LED

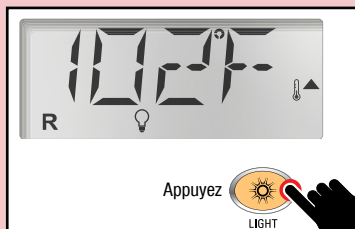

Appuyez sur le bouton "LIGHT" pour activer les lumières

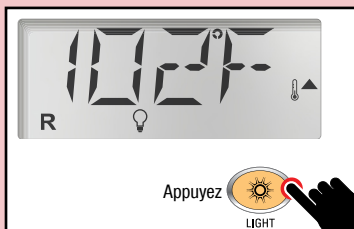

Appuyez sur le bouton "LIGHT" à plusieurs reprises jusqu'à ce que le réglage d'éclairage souhaité soit actif

## Allumez les pompes

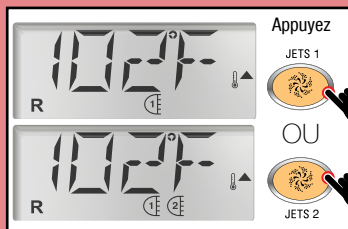

Appuyez sur le bouton "JETS 1" pour activer la pompe 1 a basse vitesse. Appuyez sur les bouton "JETS 2" pour activer la pompe 2 si disponible

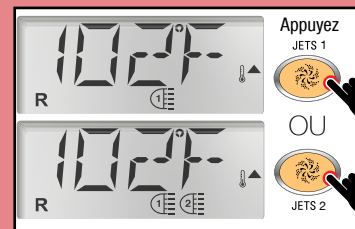

Appuyez sur le bouton "JETS 1" ou le bouton "JETS 2" une deuxième fois pour une vitesse élevée.

## Changer le mode de chauffage du spa (prêt/repos)



Appuyez sur le bouton "MENU" jusqu'à ce que votre écran affiche MODE

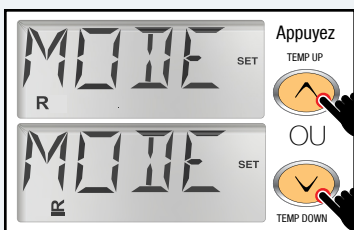

Appuyez sur le bouton "TEMP UP" ou "TEMP DOWN" pour sélectionner le mode prêt R ou de repos puis appuyez à nouveau sur le "MENU" pour terminer l'action. **Remarque: il est recommandé de laisser le spa en mode prêt (R)**

## Tournez/Inverser



Appuyez sur le bouton "MENU" jusqu'à ce que votre écran clignote FLIP

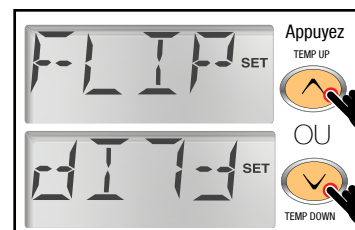

Appuyez sur "TEMP UP" ou "TEMP DOWN" pour définir l'orientation que vous souhaitez que l'écran affiche. Appuyez à nouveau sur "MENU" pour terminer l'action

## Définir la durée du filtre (en heures)



Appuyez sur le bouton "MENU" jusqu'à ce que votre écran clignote FLTR

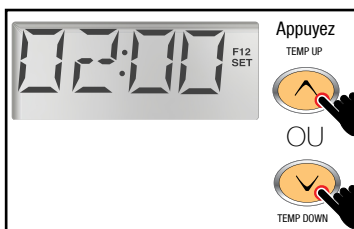

Appuyez sur le bouton "TEMP UP" ou "TEMP DOWN" pour définir le nombre d'heures que vous souhaitez que votre cycle de filtration se déroule toutes les 12 heures. Appuyez sur "MENU" à nouveau pour terminer l'action

**Remarque: 2h00 signifie que le spa filtrerait pour un total de 4 heures par jour (recommandé)**

**Pour les rappels PH, FLTR etc., maintenez l'un ou l'autre des boutons de température pour effacer le message**



# GUIDE DE DÉMARRAGE DES PRODUITS D'ENTRETIEN

## VOTRE KIT DE DÉMARRAGE

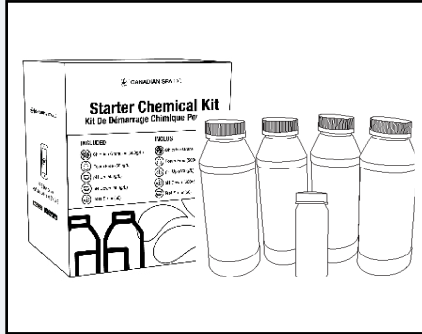

**Le kit comprend** Granules de Chlore, "Alkalinity Booster", "pH Up", "pH Down", "Test Strips"

## UTILISATION DE VOS PRODUITS CHIMIQUES

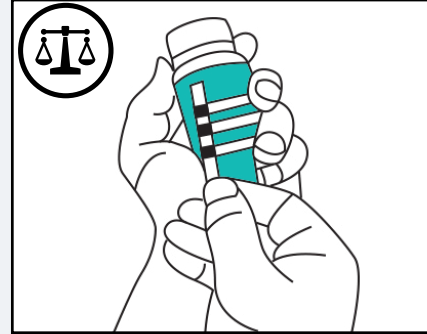

**Testez l'eau**  
Réglez dans l'ordre suivant:  
*Alcalinité, pH, Chlore*

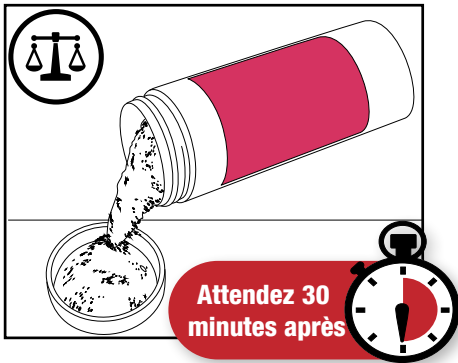

**Alkalinity Booster**  
Réglez l'alcalinité à 80-150 ppm  
(utilisez pH Moins pour réduire)  
(voir les instructions sur la bouteille)

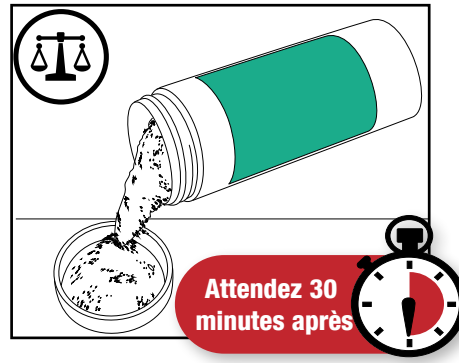

**pH Plus/pH Down**  
Réglez le pH à 7.2-7.6  
(voir les instructions sur la bouteille)

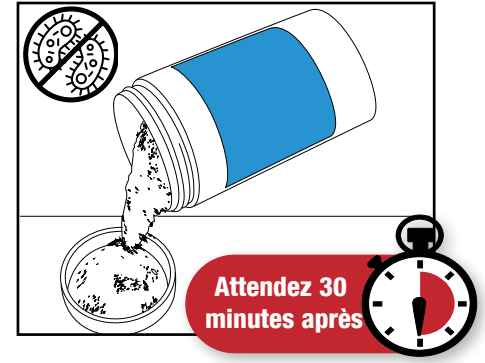

**Granules de Chlore**  
Ajoutez 15 g par 1000 L (niveau de chlore devrait être 1-3 ppm à cause du purificateur d'ozone)

## AMUSEZ-VOUS BIEN!



# PROGRAMME D'ENTRETIEN

## PROCÉDURE

CHAQUE  
USAGE

CHAQUE  
SEMAINE

3-4  
MOIS

YEARLY



### DÉSINFECTEZ

Ajustez le niveau de désinfectant



### RÉGLEZ

Réglez l'eau selon les résultats des bandelettes de test

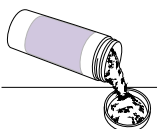

### CHOC DE SPA

Oxydez les matières organiques



### INHIBITEUR DE TARTRE

Protégez contre l'eau dure et les métaux

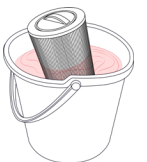

### NETTOYANT DE FILTRE

Faites tremper le filtre pendant la nuit et rincez



### BALLE DE SPA

Remplacez la balle de spa

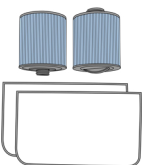

### REMPLEZ LE FILTRE

Selon l'horaire de remplacement



### SPA FLUSH

Ajoutez avant de vider le spa

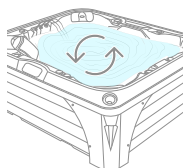

### CHANGEZ L'EAU

Videz et remplissez l'eau



### VERIFIER L'AMPOULE UV-C (vendu séparément)

S'assurer que la LED est allumée pendant le cycle de filtration



# GARANTIE LIMITÉE

## SPAS ACRYLIQUE

**Garantie structurelle:** Canadian Spa garantit la structure de la coque du spa contre la perte d'eau due à une défaillance structurelle pendant une période de **dix (10) ans** à partir de la date d'achat par le propriétaire d'origine. Si de l'avis de Canadian Spa la structure s'avère défectueuse, Canadian Spa réparera ou, à sa discrétion, remplacera la structure défectueuse sans frais pour le client.

**Garantie de surface:** Canadian Spa garantit la finition acrylique contre les défauts de matériaux et de fabrication et spécifiquement contre craquelures ou délaminages pendant une période de **deux (2) ans** à partir de la date d'achat d'origine jusqu'à l'acheteur d'origine. Si, dans l'avis de Canadian Spa, la surface s'avère défectueuse pendant cette période, Canadian Spa réparera ou, à sa discrétion, remplacera la coque de spa défectueuse sans frais pour le client.

**Garantie d'équipement/plomberie:** Canadian Spa garantit les équipements fonctionnels et la plomberie du spa restent exempts de défauts dans les matériaux et la fabrication pendant une période de **deux (2) ans** à compter de la date d'achat par l'acheteur d'origine.

**Étendue de la garantie:** Cette garantie limitée s'applique aux spas fabriqués après le **1er mars, 2021** et vendu par des concessionnaires Canadian Spa aux clients de détail résidentiels. La garantie limitée est donnée uniquement au premier acheteur au détail et prend fin avec le transfert de propriété. Aucune garantie n'est fournie sur les ampoules, les lentilles lumineuses, filtres ou tout accessoire installé par le concessionnaire. Coût d'installation, l'enlèvement et / ou l'expédition du spa ne sont pas couverts par cette garantie. Dans le cas où Canadian Spa juge nécessaire le retrait du spa à un lieu de réparation ou que le spa doit être remplacé, tous les frais de retrait et de remplacement du spa; aménagement paysager, enlèvement, altération et / ou remplacement; ou les autres frais d'accès au spa seront de l'acheteur. Cette garantie s'applique uniquement aux spas en unifamiliale, installations résidentielles. Cette garantie limitée devient nulle si le spa est mis en application commerciale.

\*\* Les modèles de plancher achetés auprès d'un détaillant autorisé sont livrés avec une garantie de deux (2) ans sur les pièces seulement \*\*

## TERMES, CONDITIONS ET LIMITATIONS

Tout défaut ou dommage causé par l'installation, la modification ou la réparation par toute personne qui n'est pas un employé de Canadian Spa ou technicien de service autorisé n'est pas couvert par la garantie. Cette garantie devient nul si le spa a été soumis à une mauvaise utilisation, abus, modification ou tentative de modification, réparation ou tentative de réparation par toute personne autre qu'un technicien de service autorisé par Canadian Spa. Mauvaise installation, chimie de l'eau incorrecte, mauvaise entretien, actes de force majeure ou dommages causés hors du contrôle de Canadian Spa. La mauvaise utilisation et l'abus de incluent toute opération du spas autres que ceux indiqués dans le manuel Canadian Spa

Les exemples de mauvaise utilisation et d'abus comprennent, sans s'y limiter:

- Dommages à la surface du spa causés par la sortie du spa découvert alors que le spa est vide d'eau ou en raison de recouvrir le spa d'un film plastique de toute sorte
- Dommages à la surface du spa causés par le contact avec nettoyeurs ou solvants non approuvés
- Dommages causés par le fonctionnement des spas à des températures d'eau en dehors de 2 à 40 degrés Celsius
- Les dommages causés par un désinfectant non approuvé tel que hypochlorite de calcium, chlore de type tri-chlore ou tout autre produit chimique désinfectant qui peut rester non dissous sur la surface du spa
- Dommages causés par le défaut de fournir un support de base uniforme pour le spa
- Dommages causés par le gel lorsque le nouveau spa n'est pas installé en temps opportun lors de températures inférieures à zéro

**Performance de la garantie:** Dans le cas où un défaut couvert par les termes de cette Garantie Limitée, veuillez en faire part à votre revendeur agréé de Canadian Spa. Un technicien agréé de Canadian Spa effectuera les réparations du spa conformément aux Termes et Conditions de cette Garantie Limitée. Utilisez tous les moyens possibles pour protéger le spa de dommages supplémentaires. Des frais de transport raisonnables peuvent être estimés par Canadian Spa ou par le technicien agréé si le spa est situé en dehors de la zone d'intervention du technicien.

**Avis de non-responsabilité:** Canadian Spa Company ou l'un de ses compagnie de services autorisé ne seront pas tenus responsables des blessures, des inconforts, des pertes d'utilisation, dégâts chimiques ou d'eau, frais de transport, continent responsabilité civile ou tout autre coût, dépense ou les dommages résultant d'un défaut ou d'une prétendue défectuosité du spa. En aucun cas, Canadian Spa ne pourra être tenu responsable, pour quelque raison que ce soit, au-delà du montant payé pour le produit. Aucune autre garantie, expresse ou implicite, sont valides. Aucun agent, revendeur, distributeur, service La société ou une autre partie est autorisée à changer, modifier ou étendre les termes de cette garantie limitée de quelque manière que ce soit. Garantie est uniquement valable avec une preuve d'achat et la plaque / numéro de série du fabricant nombre. Les dommages cosmétiques ou l'usure normale ne sont pas couverts par La garantie.



POUR PLUS DE GUIDES D'AIDE, VISITEZ-NOUS À:  
[support.canadianspacompany.com](http://support.canadianspacompany.com)  
1-877-909-7727

**North America Head Office:**  
Canadian Spa Company  
1283 Cornwall Rd,  
Oakville, ON L6J 7T5  
T: 1-877-909-7727  
[canadianspacompany.ca](http://canadianspacompany.ca)

**Canadian Spa Company LLC**  
6405 Inducon Drive West,  
Sanborn, NY 14132  
T: 1-844-879-7727  
[canadianspa.com](http://canadianspa.com)

**European Head Office:**  
Canadian Spa Company  
Canada House  
Salbrook Road  
Salfords, Redhill  
Surrey, RH1 5GL  
T: +44 1293 824094  
[canadianspacompany.co.uk](http://canadianspacompany.co.uk)

**France Office:**  
Canadian Spa Company sarl  
29 avenue de Grande  
Bretagne  
66000 Perpignan, France  
T: +33 9970 4448004  
[canadianspacompany.com](http://canadianspacompany.com)

**German Office:**  
Canadian Spa Company  
GmbH  
Hohenstaufenring 43 – 45  
50674 Köln, Germany  
TEL: + 49 22038064038  
[canadianspacompany.de](http://canadianspacompany.de)



KM-10227  
06.08.2021

Canadian Spa Company meets ISO 9001 Standards. When you purchase a hot tub from Canadian Spa Company the ISO 9001 certification assures world class excellence in manufacturing and customer service.



[canadianspacompany.com](http://canadianspacompany.com)