

Pro 10.5, 12.0, & 14.4 (Model # 1105-105, 1105-120 & 1105-140)
Laava 10.5, 12.0, & 14.4 (Model # 1105-1052, 1105-1202 & 1105-1402)
 with **Elite Control** (Type # 1601-33 and 1601-33-1)
 And / Or **Pure 2.0 Control** (Type # 1601-40 and 1601-40-1)
 And / Or **External Switch** (Type # 1601-36).

Read all instructions carefully before installation. Please leave all instructions and warranty with the owner.

WARNING

Prolonged exposure to elevated temperatures is capable of inducing hyperthermia. Hyperthermia occurs when the internal temperature of the body reaches several degrees above the normal body temperature of 98.6°F. The symptoms of hyperthermia include an increase in the normal temperature of the body, dizziness, lethargy, drowsiness, and fainting. The effects of the hyperthermia include failure to perceive heat, failure to recognize the need to exit the room, unawareness of impending hazard, fetal damage in pregnant women, physical inability to exit the room and unconsciousness.

WARNING

The use of alcohol, drugs, or medication is capable of greatly increasing the risk of fatal hyperthermia.

SECTION 1: GENERAL INFORMATION

These heaters are ETL approved by Intertek for permanent installations. All wiring must be performed in accordance with the NEC and local codes. See **Table 1** for wire and room size requirements.

These heaters are free standing, secured to the floor, with separate controls.

WARNING

Do not take a sauna if using alcohol, drugs or medications.

Pregnant women or persons with poor health should consult their physician before using any sauna.

Caution fire hazard: Do not use the sauna room for drying clothes, bathing suits, etc. Do not hang towels above heater or place any object other than the rocks supplied on the heater. If any darkening of the wall around the heater is noticed discontinue sauna use immediately.

Inspect sauna regularly for required maintenance to heater, control and benches. Replace wood surfaces which show any signs of deterioration.

The heater gets extremely hot during operation and should not be touched or burns may result.

Minors should be adequately supervised whenever near a hot or warming sauna.



SECTION 2: MOUNTING OF SAUNA HEATER

Carefully locate the heater according to the dimensions shown in Diagram 1 and bolt it to the floor. (Bolts are not supplied with the heater.) Tighten to secure the heater in place.

SECTION 3: PLACING OF ROCKS

The rocks supplied with the heater have been chosen to provide the best heater performance. Use of any other type of rock may void the heaters warranty. Never operate the heater without rocks in place! Rinse the rocks with water before placing in the heater. Place the larger rocks at the bottom and the smallest at the top. Place the rocks loosely so that the air can circulate through the heater. Packing the rocks too tightly may cause the heater high limit switch to trip. The rocks must fully cover the heating elements. Attach the guard with the screws provided.

SECTION 4: ELECTRICAL HOOK-UP

Electrical installation must be made by a licensed electrician in accordance with the National Electrical Code and local regulations.

This heater is intended for use with Premium and Trend controls only. Use of any other control will void the warranty and safety listing. The control must be installed in a dry location outside the sauna room.

The model CB 10-3 contactor is required for use with 3 phase heaters, the model CB 10-1 contactor is required for use with single phase heaters. To determine the correct wire size, refer to Table 1. Use copper supply wire only, suitable for minimum 90 degrees C. The heater must be grounded! See the heater diagrams for proper connections. The location must be selected to allow installation of the thermostat's temperature sensor shown in Diagram 1. (9 foot sensor wire supplied, but may be extended with equivalent 2 conductor wire.)

Contactor Box can be surface mounted with 4 screws to a wall or in the stud wall cavity. Refer to Diagram 1 for details.

SECTION 5: TEMPERATURE SENSOR

Route the sensor wire from the contactor box to the sensor location. It may be necessary to drill holes to string the wire through the studs or ceiling joists. Route wire harness into contactor box and connect NTC port. **Ensure low voltage wiring and high voltage wiring is separated by a minimum of 4" or an electrical barrier.** With a flat tip screwdriver, unsnap sensor cover from sensor. Mount sensor horizontally to the finished wall directly above heater 3" inches down from ceiling. Refer to Diagrams 1, 2, & 3 for installation information.

SECTION 6: HEATER SCREEN (GUARD RAIL)

Install a wooden heater guard to prevent the sauna bather from accidentally touching the sauna heater. Install the heater guard rail with the height clearances and dimensions shown in Diagram 1.

WARNING

Fire sprinkler systems used inside any sauna room should be properly rated for sauna room temperatures.

Do not pour chlorinated pool or spa water on heater. Excessive water use on heater may cause damage and void warranty.

Do not install a shower in sauna room.

Electric Shock Hazard - High voltage exists within this equipment. There are no user serviceable parts in this equipment. All installation and service to this equipment should be performed by qualified licensed personnel in accordance with local and national codes.

Do not construct sauna room so as to restrict air flow through the bottom of the heater.

Packing the rocks too tightly may cause the heater high limit switch to trip.

DIAGRAM 1

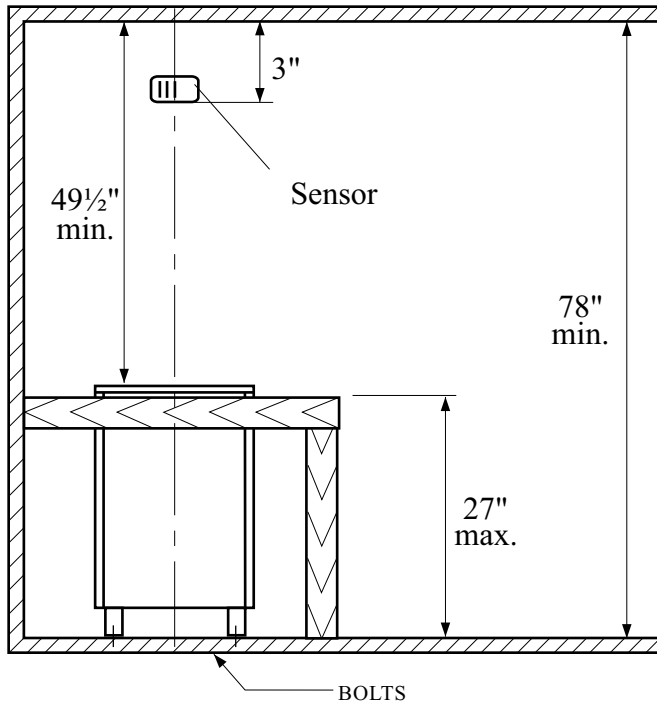

**Pro Heater
Model # 1105-XXX**

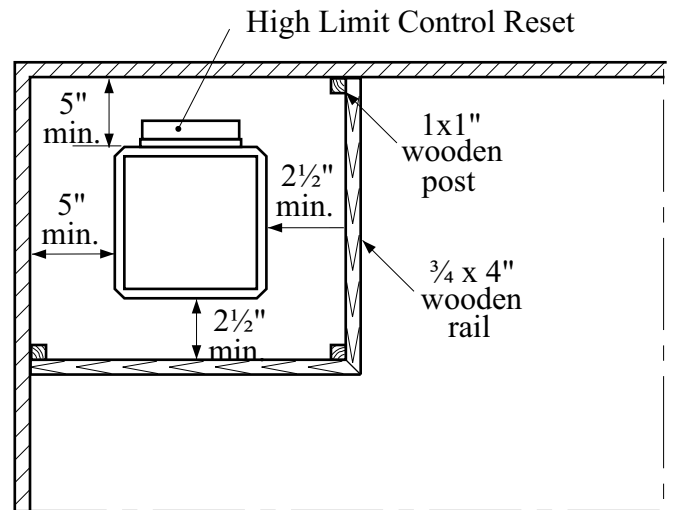

CAUTION: Avoid fire, Do Not Place Combustible Material on sauna heater / **ATTENTION:** Evitez les Incendies, Ne Placez Aucune Matière Combustible Sur Le Chauffe-saun



OBSERVING MINIMUM DISTANCES IS REQUIRED TO REDUCE THE RISK OF FIRE

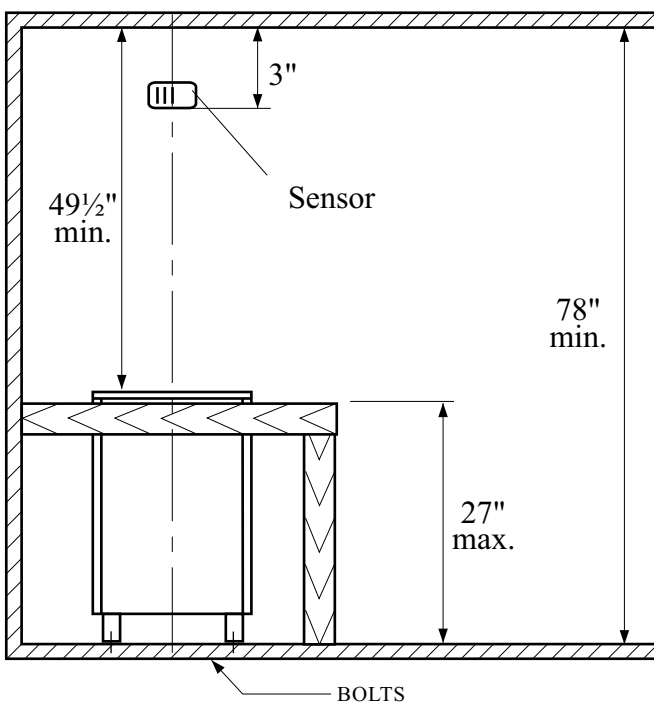

**Laava Heater
Model 1105-XXX2**

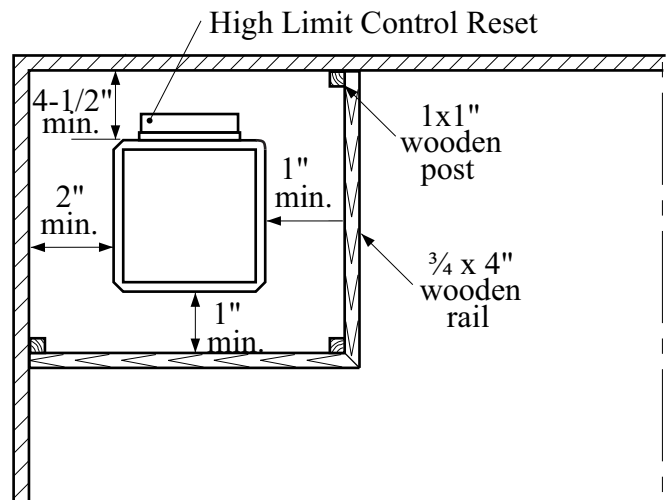
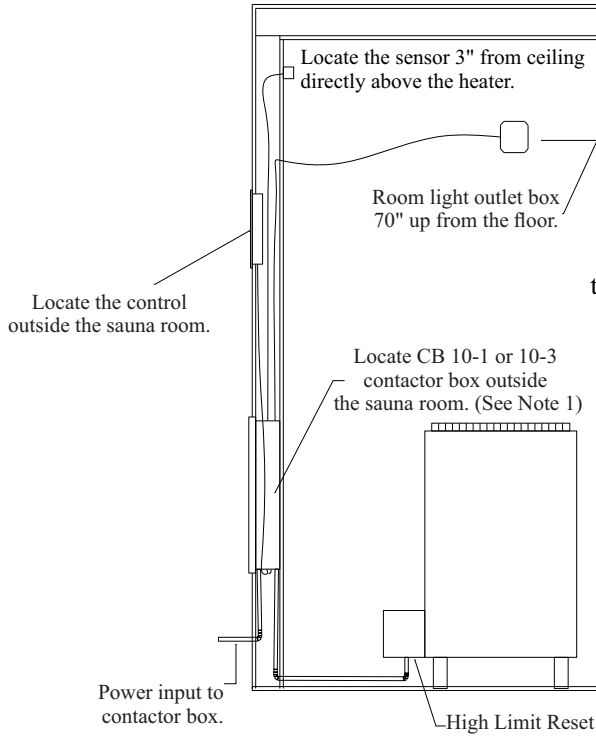
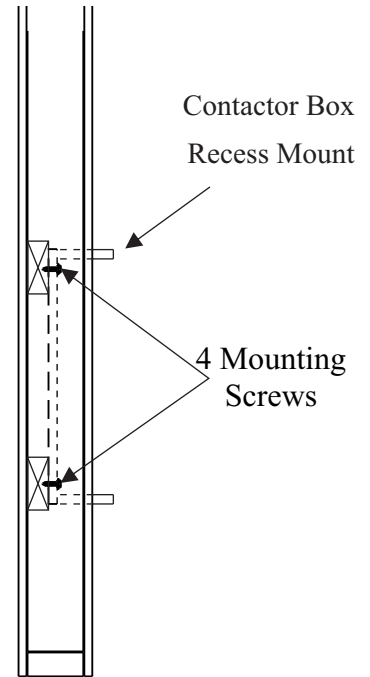

DIAGRAM 1



All wiring for sauna system or accessories should be routed inside the walls or away from the high temperature air from the sauna heater.

Controls CAN NOT be installed above the sauna heater inside the room.



Note 1: The contactor box may be mounted anywhere outside the sauna room. A location should be selected so the front cover is accessible for service and the noise of the contactor pulling in will not be a nuisance.

Provide a service loop into the sauna room to the proposed heater location.

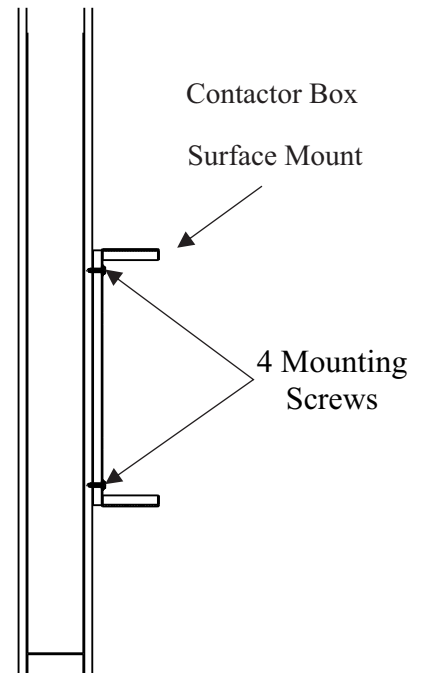
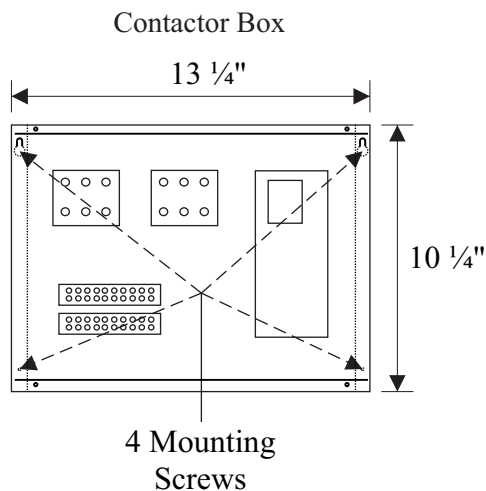

TABLE 1

Heater Model / Product Number	KW	Minimum Room			Maximum Room		Phase	VAC	* Amps	Copper Wire Size 90° C	Contactor Model	** Breaker # and Size	Power Supply to Contactor	Contactor to Heater	Contactor to Heater High Limit	Contactor to Control	Light Circuit or Fan Circuit
		Floor Area	Wall Height	Volume Cu.Ft.	Wall Height	Volume Cu.Ft.											
Pro 10.5 (1105-105) or Laava 10.5 1105-1052	10.5	48 sq. ft.	78"	390	96"	600	1	208	50.5	CB 10-1 1201-10-1	2 x 40 Amps	4 #8AWG +N+GR	4 #8AWG +GR	2 #14AWG	(Factory Supplied)	1 #14AWG +N+GR	
							1	240	43.8		2 x 30 Amps	4 #10AWG +N+GR	4 #10AWG +GR	2 #14AWG	(Factory Supplied)	1 #14AWG +N+GR	
							3	208	29.1	CB 10-3 1201-10-3	1 x 40 Amps	3 #8AWG +N+GR	3 #8AWG +GR	2 #14AWG	(Factory Supplied)	1 #14AWG +N+GR	
							3	240	25.3		1 x 40 Amps	3 #8AWG +N+GR	3 #8AWG +GR	2 #14AWG	(Factory Supplied)	1 #14AWG +N+GR	
Pro 12.0 (1105-120) or Laava 12.0 1105-1202	12.0	63 sq. ft.	78"	510	96"	740	1	208	57.7	CB 10-1 1201-10-1	2 x 40 Amps	4 #8AWG +N+GR	4 #8AWG +GR	2 #14AWG	(Factory Supplied)	1 #14AWG +N+GR	
							1	240	50.0		2 x 30 Amps	4 #8AWG +N+GR	4 #8AWG +GR	2 #14AWG	(Factory Supplied)	1 #14AWG +N+GR	
							3	208	33.3	CB 10-3 1201-10-3	1 x 40 Amps	3 #8AWG +N+GR	3 #8AWG +GR	2 #14AWG	(Factory Supplied)	1 #14AWG +N+GR	
							3	240	28.9		1 x 40 Amps	3 #8AWG +N+GR	3 #8AWG +GR	2 #14AWG	(Factory Supplied)	1 #14AWG +N+GR	
Pro 14.0 (1105-140) or Laava 14.0 1105-1402	14.4	78 sq. ft.	78"	630	96"	950	1	208	69.2	CB 10-1 1201-10-1	2 x 40 Amps	4 #8AWG +N+GR	4 #8AWG +GR	2 #14AWG	(Factory Supplied)	1 #14AWG +N+GR	
							1	240	60.0		2 x 40 Amps	4 #8AWG +N+GR	4 #8AWG +GR	2 #14AWG	(Factory Supplied)	1 #14AWG +N+GR	
							3	208	40.0	CB 10-3 1201-10-3	1 x 50 Amps	3 #6AWG +N+GR	3 #6AWG +GR	2 #14AWG	(Factory Supplied)	1 #14AWG +N+GR	
							3	240	34.6		1 x 50 Amps	3 #6AWG +N+GR	3 #6AWG +GR	2 #14AWG	(Factory Supplied)	1 #14AWG +N+GR	

* Total amp draw of combined circuits and accessory circuits.

** Single phase heaters are supplied power from two circuits which must be grouped and marked per NEC.

DIAGRAM 2

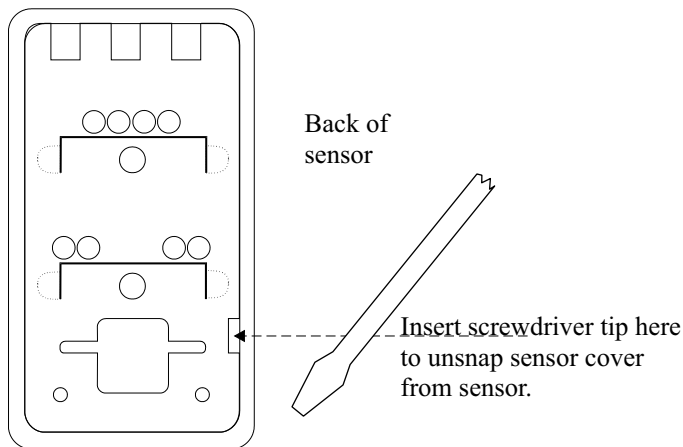

DIAGRAM 3

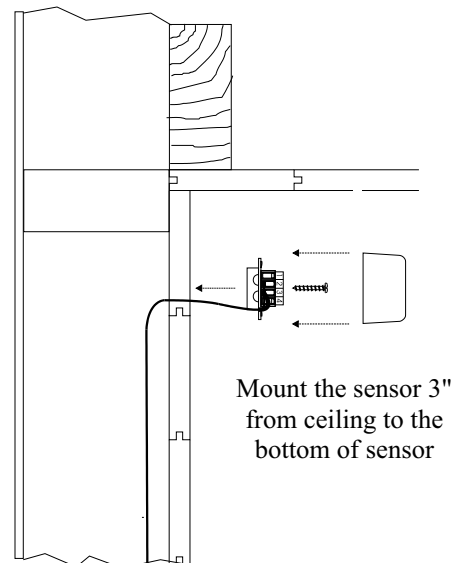

DIAGRAM 4

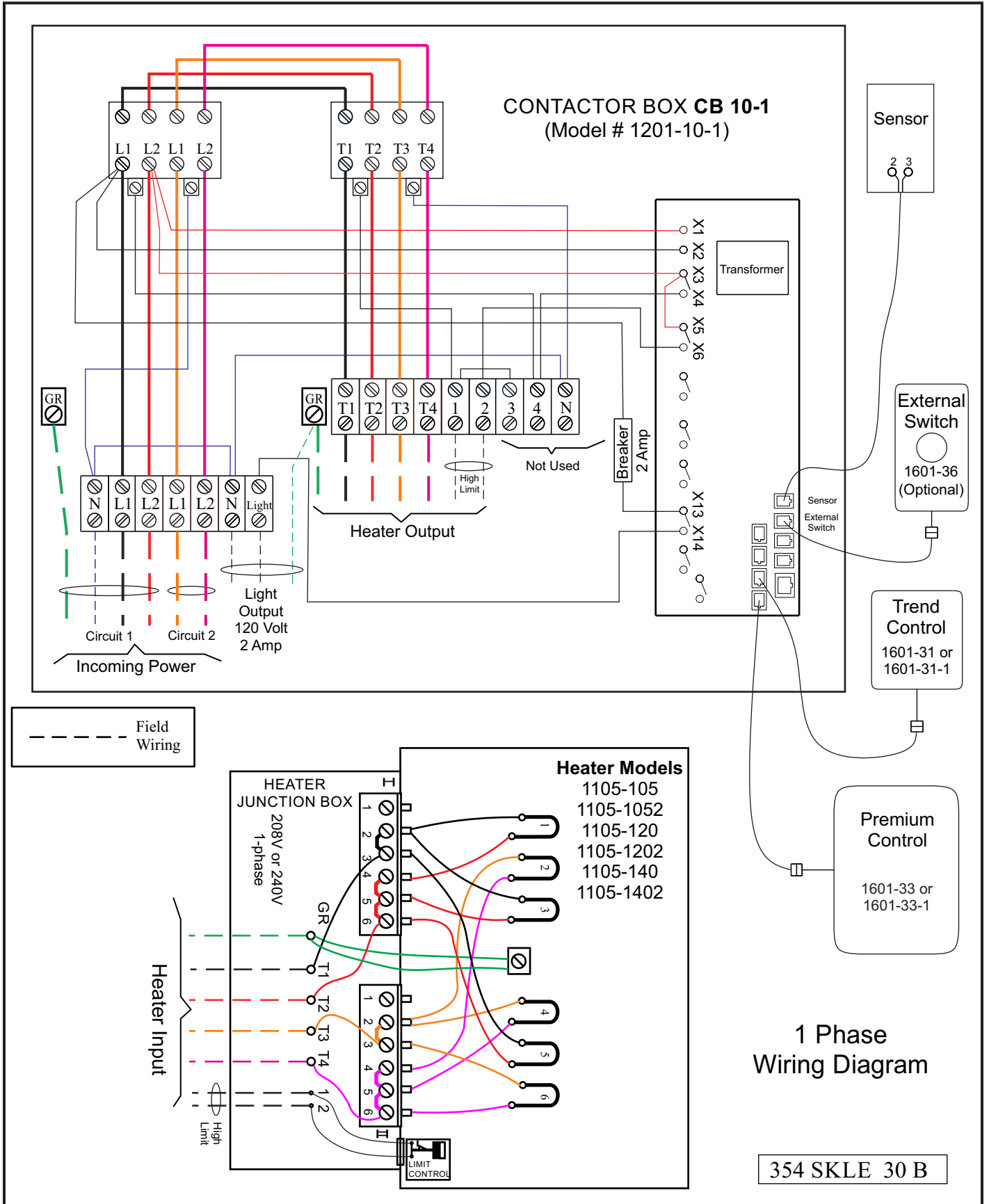

DIAGRAM 4, Continued

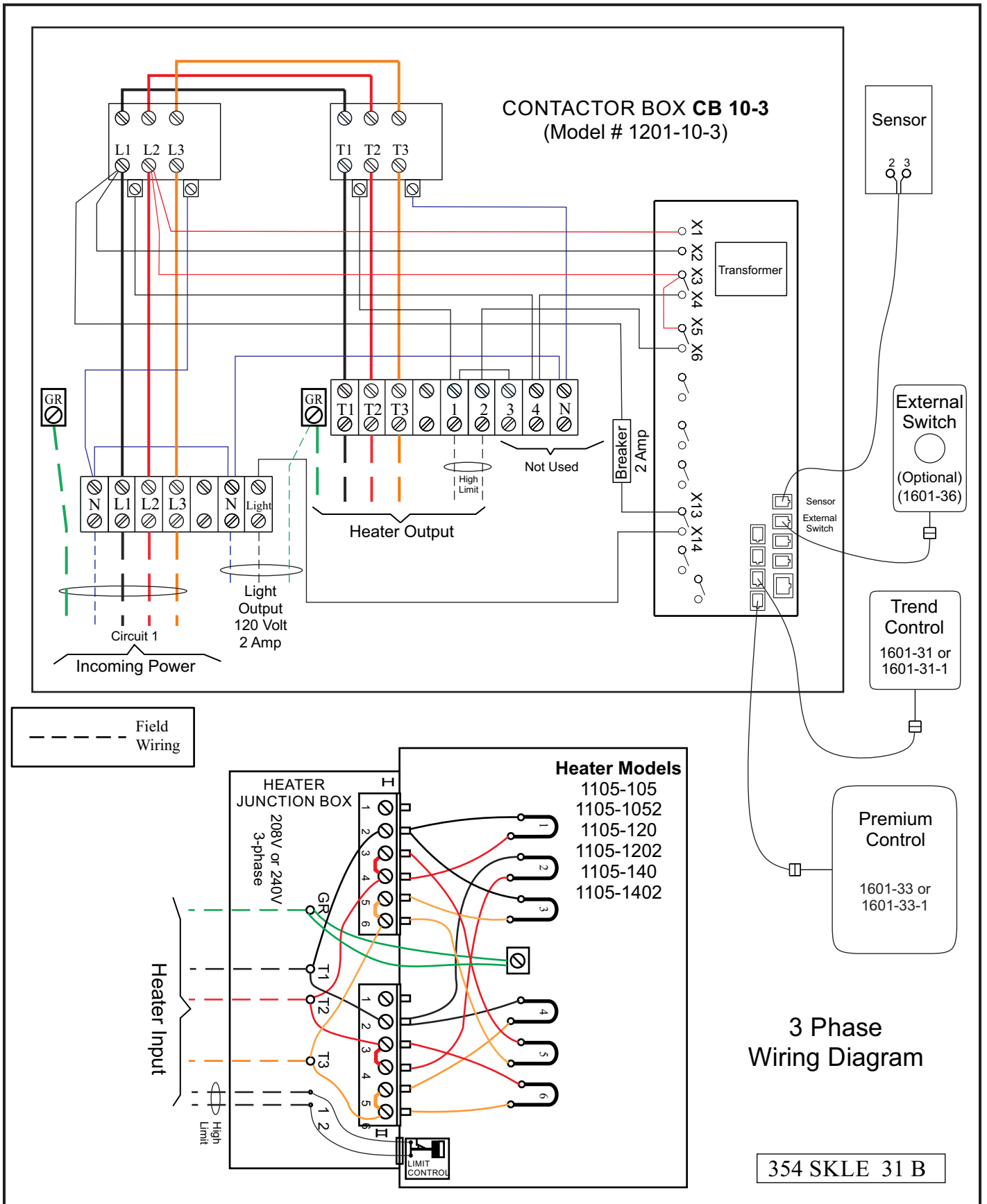

DIAGRAM 4, Continued

1 Phase Block Wiring Diagram

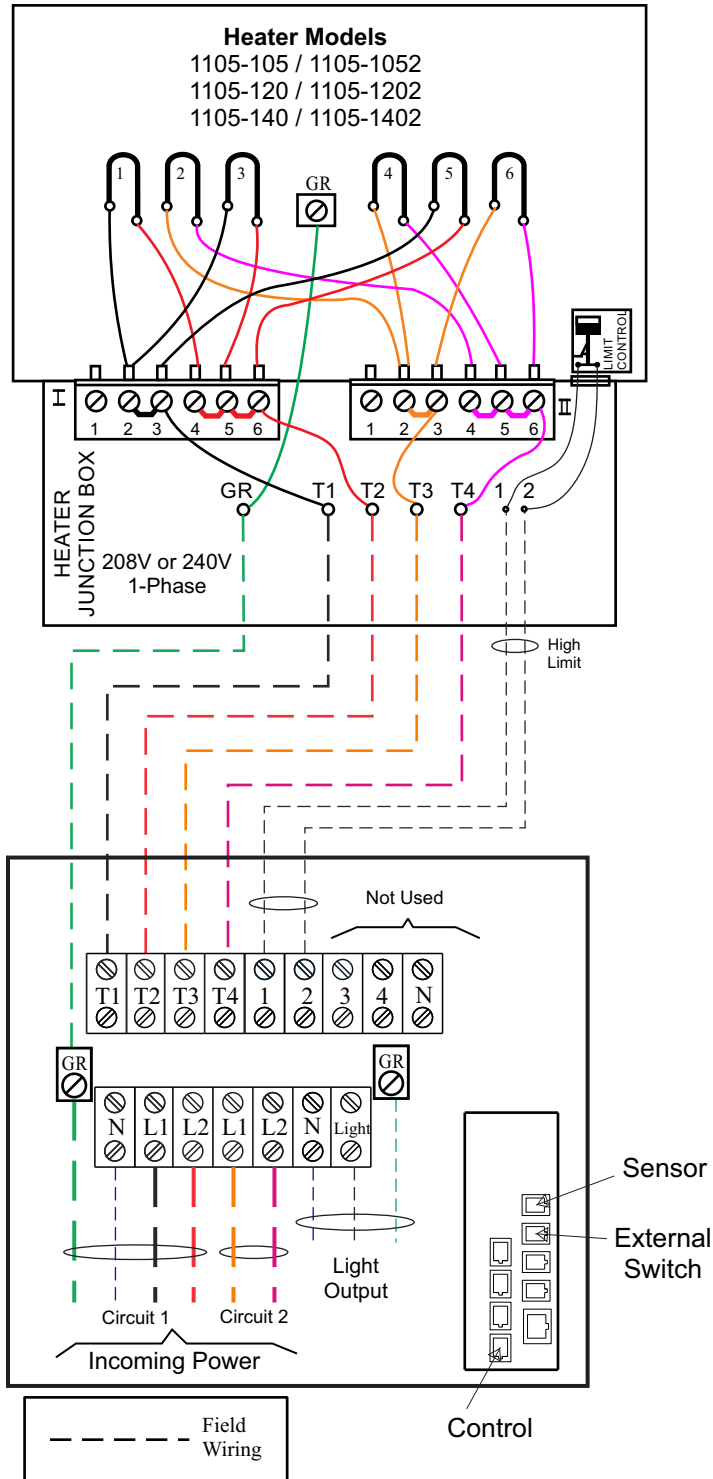
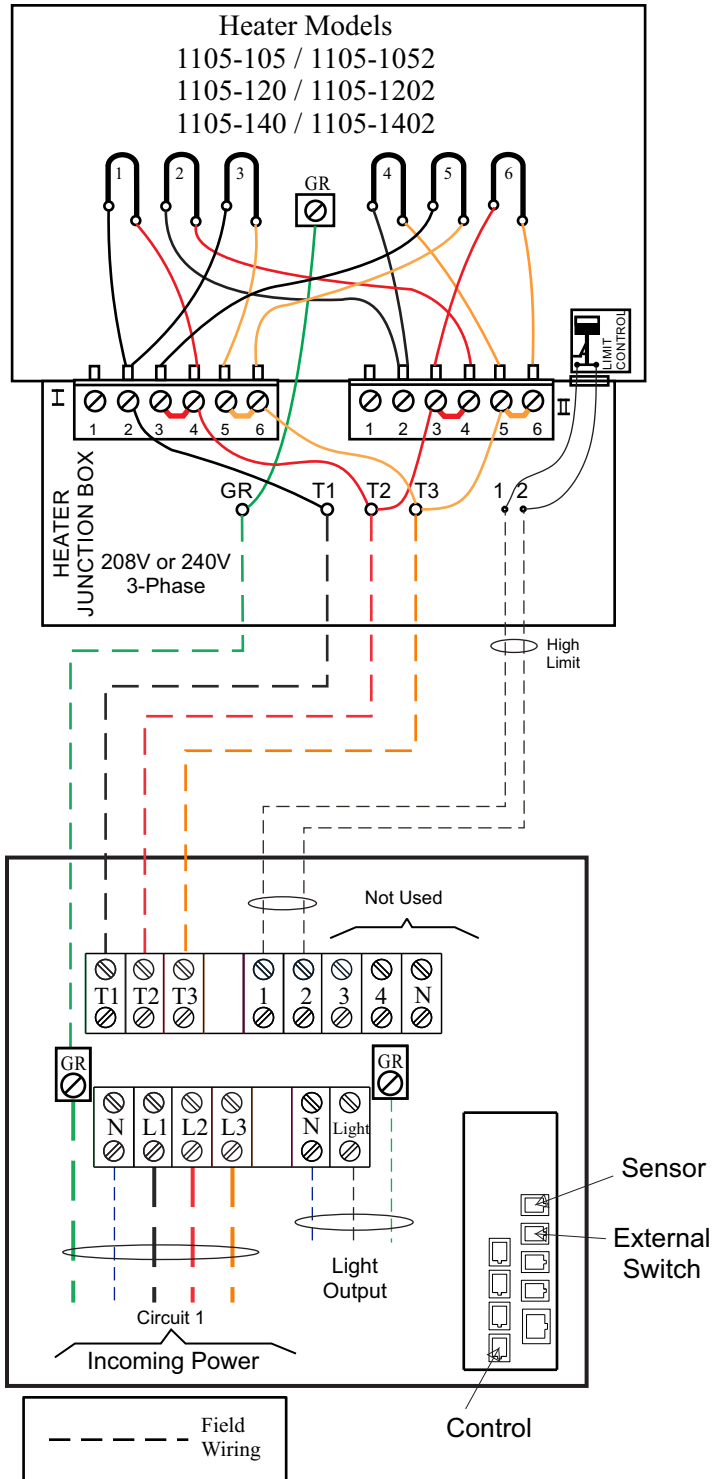

DIAGRAM 4, Continued

3 Phase Block Wiring Diagram



SECTION 7: CONTROL INSTALLATION & OPERATION

CONTROL OPTIONS: This heater has two different control options. An Elite Control (1601-33 or 1601-33-1) or Pure 2.0 Control (1601-40 or 1601-40-1) can be connected to the heater. This heater can support both at the same time as another option.

INSTALLATION ROUGH IN: Place the control inside or outside the sauna room. If the control is installed inside a sauna room, the top of the unit cannot be higher than 48 inches above floor. Maximum control cable length is 100 feet.

String the provided low voltage control cable through 1" holes in the wall studs or ceiling joists from the control location to the heater. Do not use staples to secure the low voltage cable, it may damage the cable!

Plug the control cable into the control and TEST the control BEFORE mounting!!

Premium Control can be SURFACE MOUNTED or RECESSED MOUNTED.

SURFACE MOUNTING CONTROL: After testing is complete, CLEAN the mounting surface to ensure it is free from dust. Remove the adhesive tape from the back of the control, push any excess cable into wall cavity and press the control to the mounting surface. (Do not use the Mounting Box or Trim Ring for this installation.)

WARNING

Do not locate benches over heater. Refer to Diagram 1 for minimum clearance of ceiling above heater is required.

Minimum clearance from heater to wooden surfaces (benches, side walls, heater fence etc.) is required. Refer to Diagram 1 for specific information.

Use only copper wire of the size and type indicated in the Heater Specification Chart and the temperature rating indicated on the heater junction box.

All heaters and controls must be grounded per NEC to prevent electrical shock in case of unit failure.

Electrical outlets or receptacle must not be installed in a sauna room.

A guardrail or fence is required around the heater to prevent burns from accidental contact.

SECTION 7: ELITE CONTROL (1601-33 or 1601-33-1) OPERATION

Home Screen

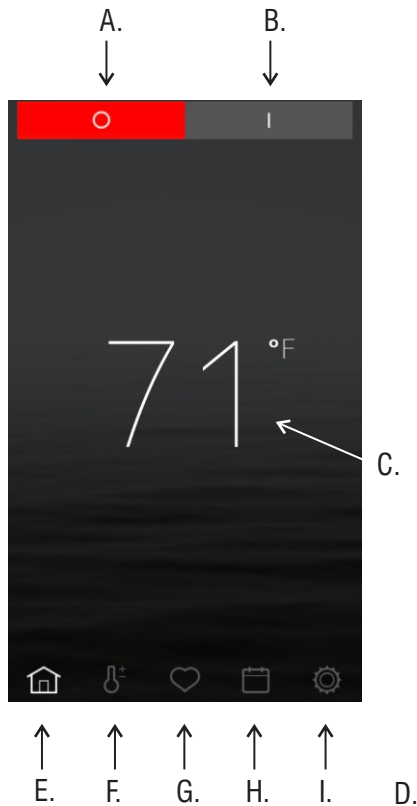



- A. - Off Button
- B. - On Button
- C. - Current Room Temperature
- D. - Home Button
- E. - Temperature Button
- F. - Favorites Button
- G. - Calendar Button
- H. - Settings Button

To Start Immediately

1. Press the  icon in the upper right corner
2. Icon will change color 
3. System has started

Note: The sauna room current temperature is C.

 The **Home** button: touch this to return to the main screen. Here you will see the current temperature in the steam room, the bath temperature setting, the remaining bath time (if any) and the time of day. Touch the screen to show the bath and Warm Start on/off buttons, too.

 The **Settings** button: touch this to display the Settings screen. Here you can adjust the temperature and duration for the current bath. You can also manually turn on the installed options when the bath is on (and turn on some options, such as Lights, when the bath is off). You can also save your settings as a favorite so you can always have them available for your steam bath without having to change settings after someone else has a steam bath.

 The **Favorites** button: Here you can select a bath with your favorite settings, once you've saved it.

 The **Calendar** button: Here you schedule a steam bath to start and run at a later time. You can select by the day of the week or using a calendar month and select for one time bath or recurring.

 The **Tool** button: here you make the many selections for what functions and options are available to be used, set a PIN to limit who can change settings, and much more.

The **Change Menu** arrows are used to move between related menu screens. Press < to return to the previous screen or > to continue to the next one.

SECTION 7: ELITE CONTROL (1601-33 or 1601-33-1) OPERATION, Continued

Temperature Screen Options

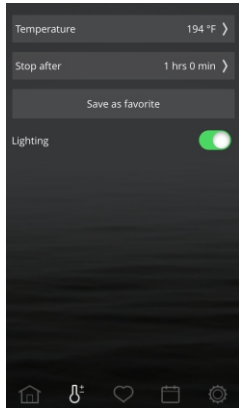

Temperature and Room Light

Change temperature by pressing + or - to desired temperature.
 Press the Lighting icon to turn On or Off the room light.
 Press Screen
 Press button in upper right corner to start sauna.

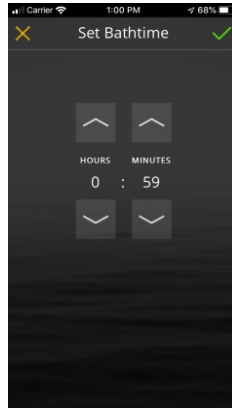

Sauna Duration

Change sauna length by pressing the **Stop After** button
 Change to desired length (normal setting is 1 hour)
 Press the to accept the change

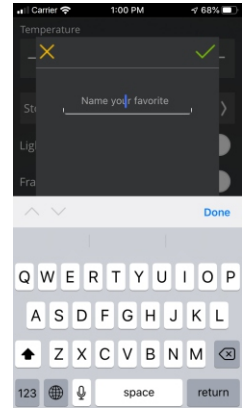

Creating Favorites

Ensure temperature and sauna length are correct.
 Press **Save as Favorite**
 Type in Name and press
 Press the to accept information.

Favorites Screen Options

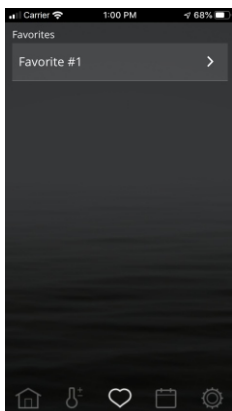

Favorites

Select the Favorite to edit or start program

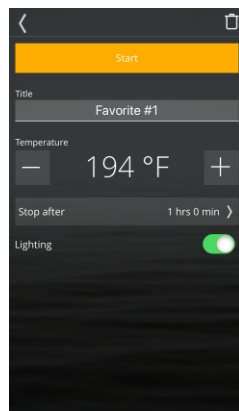

Favorite's Settings

Click on Title to change name
 Change temperature by pressing + or - to desired temperature.
 Change to desired length (normal setting is 1 hour)
 Press to activate program.



Home Screen

Home Screen will appear and the sauna heater will be started. The temperature setting is the favorite just chosen.

SECTION 7: ELITE CONTROL (1601-33 or 1601-33-1) OPERATION, Continued

Calendar Screen Options

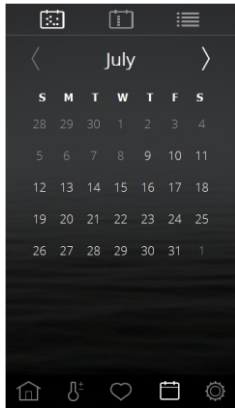

Adding One Time Event

Click the date for the event.

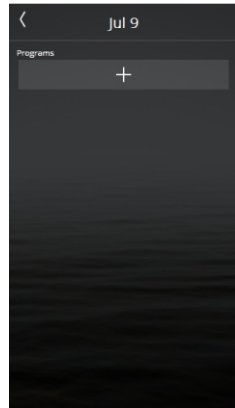

Adding One Time Event

Click the + to add event.

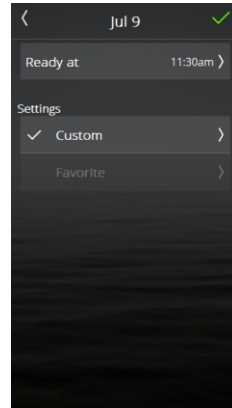

Adding One Time Event

Select the sauna duration and temperatures.

Press the ✓ to accept information.

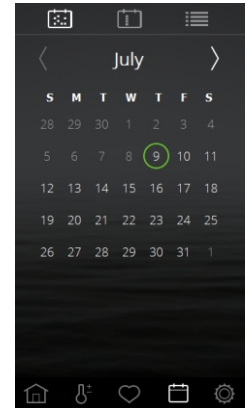

Calendar Showing Event Scheduled

The  indicated a program is scheduled on the date.

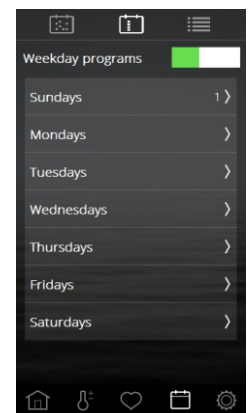
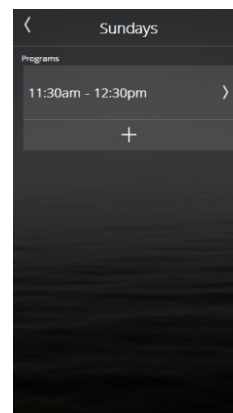
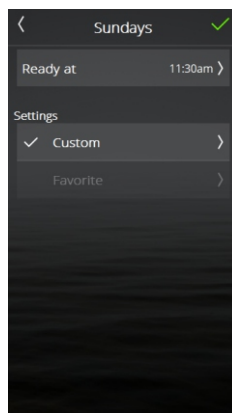
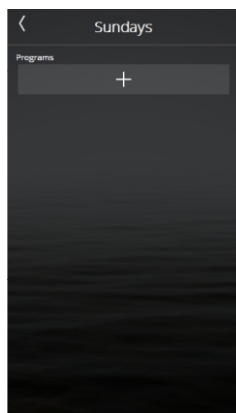
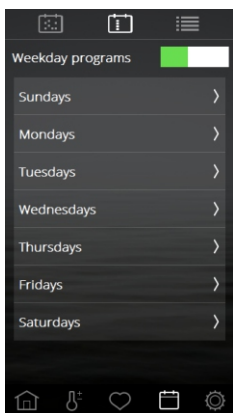

Adding Recurring Event

Select the  button at the top of screen to chose Recurring Event

Click the day of the week for the event.
Select the + to add event.

Select the sauna duration and temperatures.

Press the ✓ to accept information.

Next screen will show 1 event created for the day of the week.

Repeat the process to create multiple events.

SECTION 7: ELITE CONTROL (1601-33 or 1601-33-1) OPERATION, Continued

Calendar Screen Options

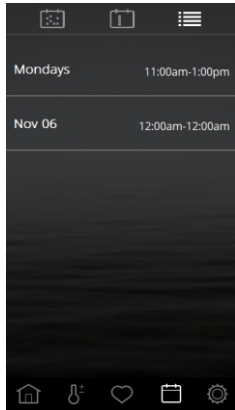

Viewing Scheduled Events

Click the  in the upper right corner to see events.

Setting Screen Options

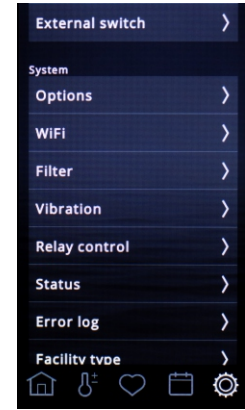
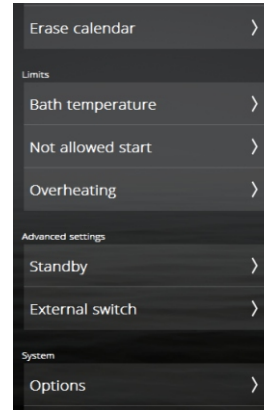
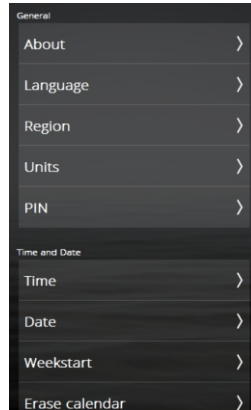

Setting Options

Select the  icon in the lower right corner of the control to access settings.

WiFi Setup Screen

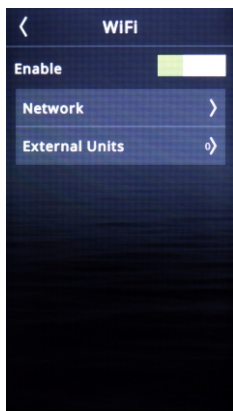

Connect Control to WiFi Network

Select the WiFi option from Setting Screen

Select Network Option

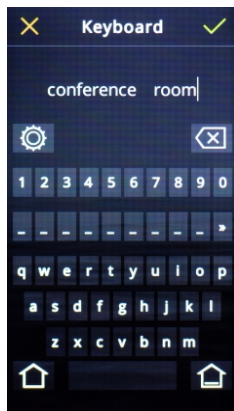

Select Name

Select Name and name the Control

Enter Name and select  to accept.

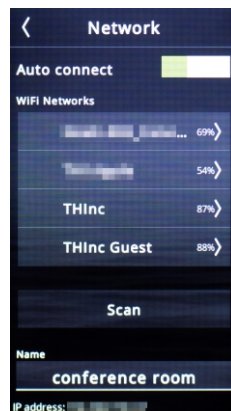

Choose WiFi Network

Select Scan to see all WiFi Networks

Select network to connect

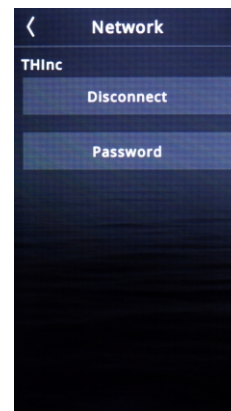

Connect Control to WiFi Network

Select Password

Enter password and select  to accept

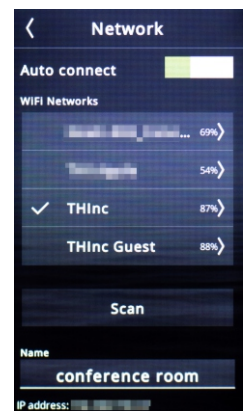

WiFi Network

Check mark indicates control is connected to network

Networking: This control can connect to a Local WiFi Network to be operated by a Phone Application or PC Application. Download the application from the Google Playstore or Apple Store. Search for sauna brand name and download the free application.

SECTION 7: ELITE CONTROL (1601-33 or 1601-33-1) OPERATION, Continued

Phone Application Setup Screen

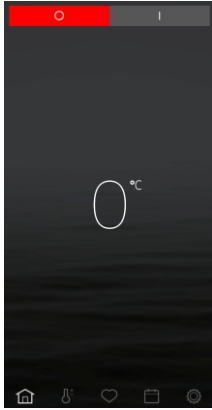

Application Home Screen

Select the Settings  icon.

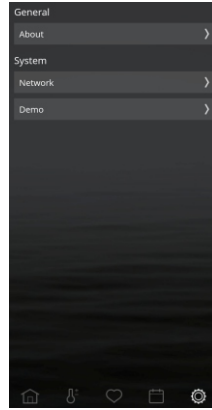

Network

Select network

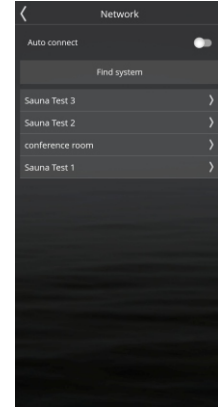

Choose Sauna Control

Phone must be connected to the same network as Sauna Control

Press Find System

Choose Control

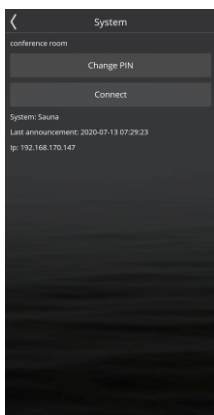

Connect to Control

Select connect

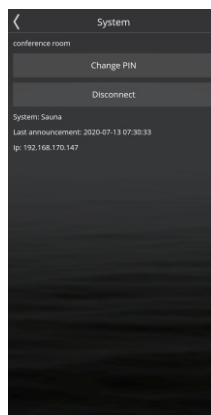

Network Screen to Home Screen

Select the < in upper left corner to go back one screen to Network Screen

Select the < in upper left corner to go back one screen Home Screen.

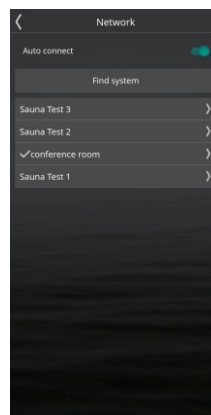

SECTION 7: PURE 2.0 CONTROL (1601-40 or 1601-40-1) OPERATION, Continued

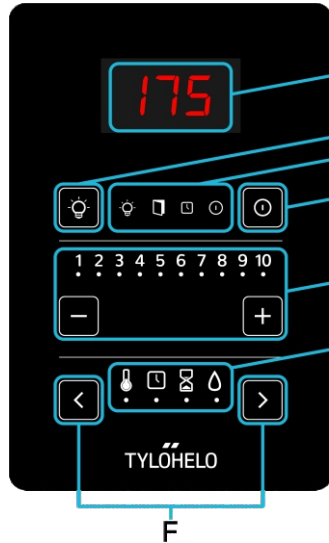

- A. On/Off Light switch
- B. Indicators - lights for lighting, door switch (n/a), timer and the heater
- C. On/Off Sauna Switch and fault alarms
- D. Sets the desired value
- E. Functions - Temperature, Delay Timer, Sauna Length and Humidity (n/a)
- F. Function buttons
- G. Temperature Display - Current Temperature

CONTROL OPERATION:

TURN ON LIGHT: Press the "light bulb" icon once to turn on the light and press again to turn off. (Usage of light control is optional)

SAUNA LENGTH: (Control 1601-40) Select the sauna length function by pressing the buttons < > (F). Set the desired usage time (0–60 minutes) using the – and + buttons. (Setting 10 equals 60 minutes)

(Control 1601-40-1) Usage time is 0 - 24 hours operation
(Setting 1 = 2 hours, setting 10 = 24 hours)

Version	LED									
	1	2	3	4	5	6	7	8	9	10
1 hour	6 min	12 min	18 min	24 min	30 min	36 min	42 min	48 min	54 min	60 min
24 hour	2 hr	4 hr	6 hr	8 hr	10 hr	12 hr	14 hr	16 hr	18 hr	24 hr

SECTION 7: EXTERNAL SWITCH CONTROL (1601-36) OPERATION

External Switch

This momentary, illuminated switch provides simple ON/OFF function to your Trend or Premium Sauna Control. In a commercial environment, it is recommended that the main Sauna Control be located either in a utility closet or at the Attendant's desk so the sauna time and temperature functions can be secured from the general public. This optional external switch will provide the sauna bather with the ability to turn the sauna ON or OFF only.

When the momentary switch is activated, the power icon will illuminate in blue and activate the sauna session that has been programmed into the main control (Trend or Premium).

Activating this button will also turn the interior sauna light on, if the light has been wired to the light output on the sauna heater's PCA board.

Pressing the switch when it is illuminated will remove power to the sauna heater and end the bathing session.



This switch cannot function as a control. It has to be connected to the system with another control.

SECTION 8: LIMIT CONTROL (RESET BUTTON)

The sauna heater has a built-in High Limit control, which automatically turns off the heater if the temperature inside in the sauna room rises to an abnormally high level.

To restart the heater, let the heater cool and the timer run down to zero (off), then push the reset button on the bottom of the heater, See Diagram 1. If the High Limit continually shuts off the heater, refer to Section 14 for Troubleshooting.

SECTION 9: HOW TO TAKE A SAUNA

- When taking a sauna, allow time to relax completely.
- Remove clothing and jewelry...if required, wear a towel loosely.
- After 10 minutes or when perspiration begins, leave sauna and relax in dressing area...follow with a cool shower.
- Cooling time should equal time spent in sauna. Enter sauna room again and stay 5 or 10 minutes.
- Repeat the cycle 2 or 3 times; end with a brisk shower...rinse in cool water.
- Dress when completely dry and perspiration has stopped.
- Some sauna bathers enjoy the soothing effect of steam by splashing water on the heated sauna rocks. Use only one dipper full (approx. ½ cup) at a time and take care to keep clear of the steam as it rises off the rocks.
- Do not smoke, exercise or drink alcoholic beverages in the sauna room.
- Do not pour chlorinated pool or spa water on the heater or corrosion damage may result.

SECTION 10: WARNING PLACARDS

Two metal placards are included in the Installation Instruction Envelope packaged with every Sauna Heater. The CAUTION placard must be attached to the interior wall of the sauna room directly above the heater where it is visible to the bather. The WARNING placard must be attached to the door of the sauna room.

SECTION 11: ROOM CONSTRUCTION

- For safety and reliability, the following rules must be addressed.
- No permanent locking or latch system is to be used on the sauna door.
- Acceptable door fittings are: magnetic catches, friction catches, spring or gravity loaded closures.
- The door must always open outwards.
- No shower may be installed in a sauna room.
- No electrical receptacle shall be installed inside the sauna room.
- The enclosed WARNING: Reduce the risk of overheating ... warning plate must be mounted on or alongside the door outside the sauna room at about eye level.
- The enclosed CAUTION: Reduce the risk of fire ... caution plate must be mounted on the interior wall above the heater.
- The heater should not be operated without its container properly filled with rocks and the rock guard in place.
- If an intercom speaker is installed, it should be away from the heater and as close to the floor as possible.
- Fire sprinkler systems installed inside any sauna room should be properly rated for sauna room temperatures.
- Always mount the heater according to these installation instructions.
- Minimum of R12 insulation in 16" on center 2x4 stud walls.
- Recommended minimum flooring thickness of 5/8"



Shower



Sauna (10 - 15 min.)



Shower or swim

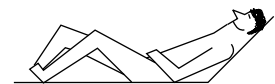

Rest (10 - 15 min.)



Relax with juice or water

You liked it?
Do it once again and
you will feel great.

DIAGRAM 5

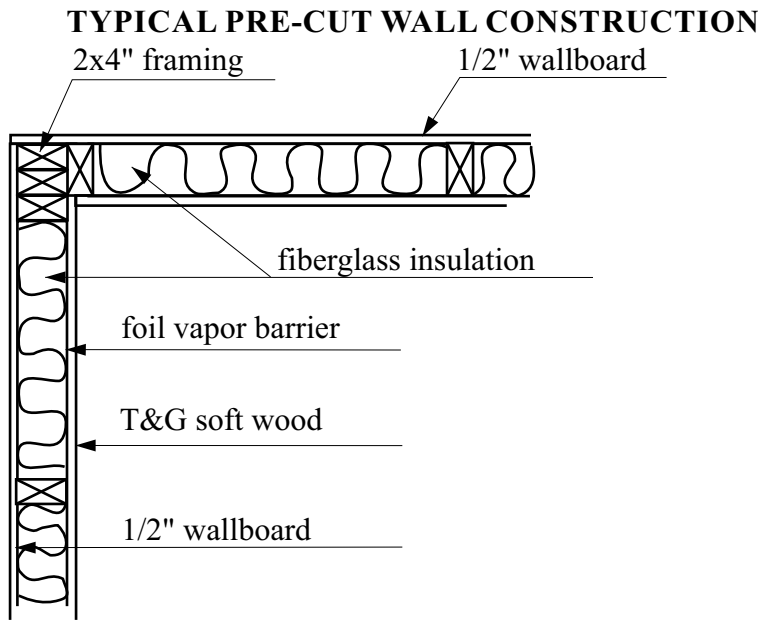

SECTION 12: VENTILATION

VENTILATION Ventilation shall be provided in a sauna, the air should be changed about 6 times an hour. This can be achieved by making a vent opening (fresh air inlet) in the sauna wall directly below the heater. The air outlet must be lower than the upper benches, as far as possible from the heater and about two feet higher than the fresh air inlet vent, See Diagram 6.

The minimum opening should be determined using one of the following formulas:

For $R < 31$, $V \geq 9.4$
 For $R \geq 31$, $V \geq 0.3R$

R = the floor area of the room in square feet
 V = the minimum vent size in square inches

DIAGRAM 6

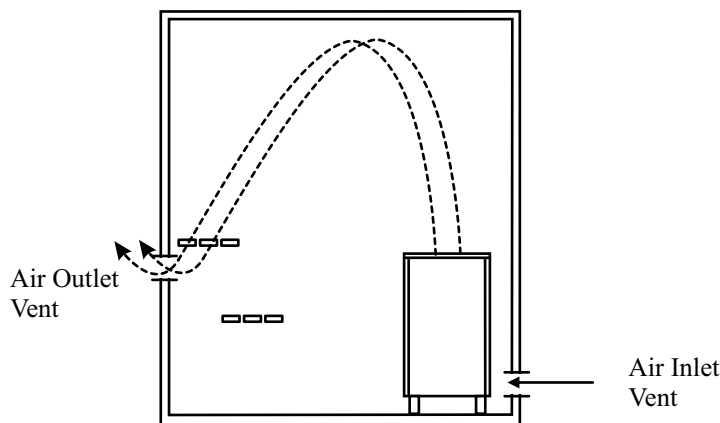

The "CAUTION" and "WARNING" placards must be mounted in accordance with Section 10.

⚠ WARNING

REDUCE THE RISK OF OVERHEATING

- * Exit immediately if uncomfortable, dizzy, or sleepy. Staying too long in a sauna is capable of causing overheating.
- * Supervise children at all times.
- * Check with a doctor before use if pregnant, in poor health, or under medical care.
- * Breathing heated air in conjunction with consumption of alcohol, drugs, or medication is capable of causing unconsciousness.

⚠ CAUTION

REDUCE THE RISK OF FIRE

Do Not Place Combustible Material On The Heater At Any Time.

For safety purpose sauna door must open out and not lock.

Never use a wood stain, seal or preservative on the inside of your sauna room.

Light fixtures get very hot during operation. Locate light fixture where it will not be a burn hazard.

SECTION 13: MAINTENANCE

Inspect sauna room at the end of each day the room to ensure the control and system is off.

The sauna, like a bathroom, should be kept clean and odor free. Towels or mats should always be used on benches and floor as perspiration otherwise penetrates the soft wood.

Air out the sauna often by keeping the door and vents open when the sauna is not in use. Saunas that are in daily use should be washed down at least once a week to keep them clean and the air fresh. Duckboard should be removed from the sauna, the sauna floor mopped and dried in a conventional manner, and the duckboard thoroughly scrubbed and dried before returning to the sauna room. The sauna heater should be wiped down occasionally with a damp cloth to remove lint and dust. The rocks should be removed once a year for cleaning and small or crumbled rocks replaced.

To clean and remove perspiration stains, use soap or detergent in warm water, best applied with a scrub brush. Badly soiled surfaces may require sanding. Sand paper wrapped around a wooden block works well.

Benches and supporting structure must be inspected annually for potential deterioration due to age, dry rot or abuse. Any boards with signs of deteriorations should be replaced immediately to avoid possible injury.

DIAGRAM 7: ROOM TEMPERATURES

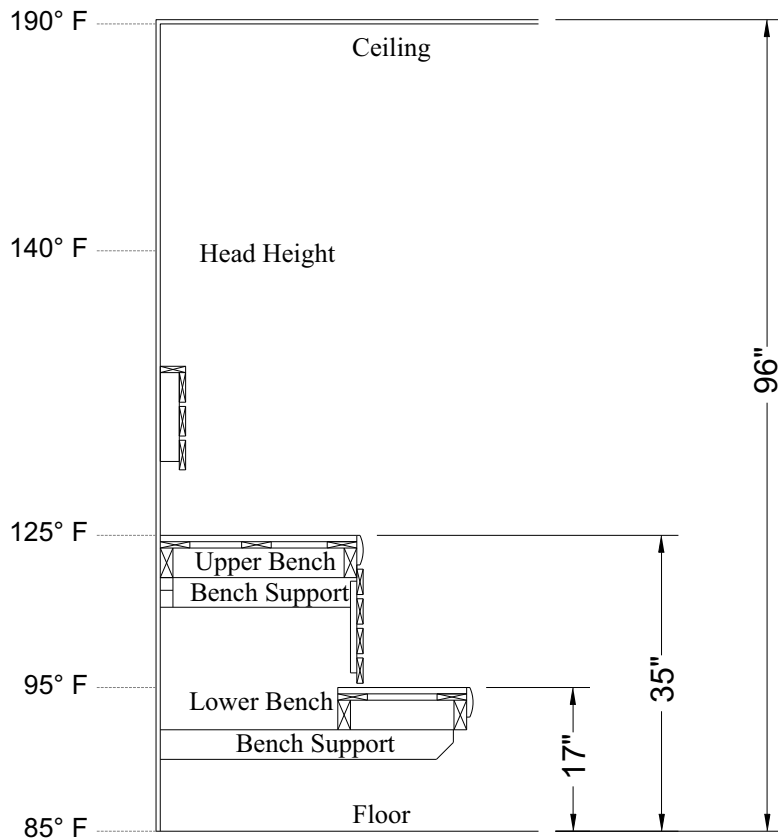

Non-Typical Ceiling Height

Notes:

Temperatures vary in a sauna room by height and distance from heater.

Ventilation will help reduce it but will not eliminate temperature variations.

The hottest part of the room is always at the ceiling directly above the sauna heater and should not exceed 194°F (90°C).

Air temperature will be 15°F to 25°F lower on the opposite side of the room from the heater close to the ceiling.

The temperatures in the elevated view are general numbers. Each sauna room is different due to construction variations and ventilation.

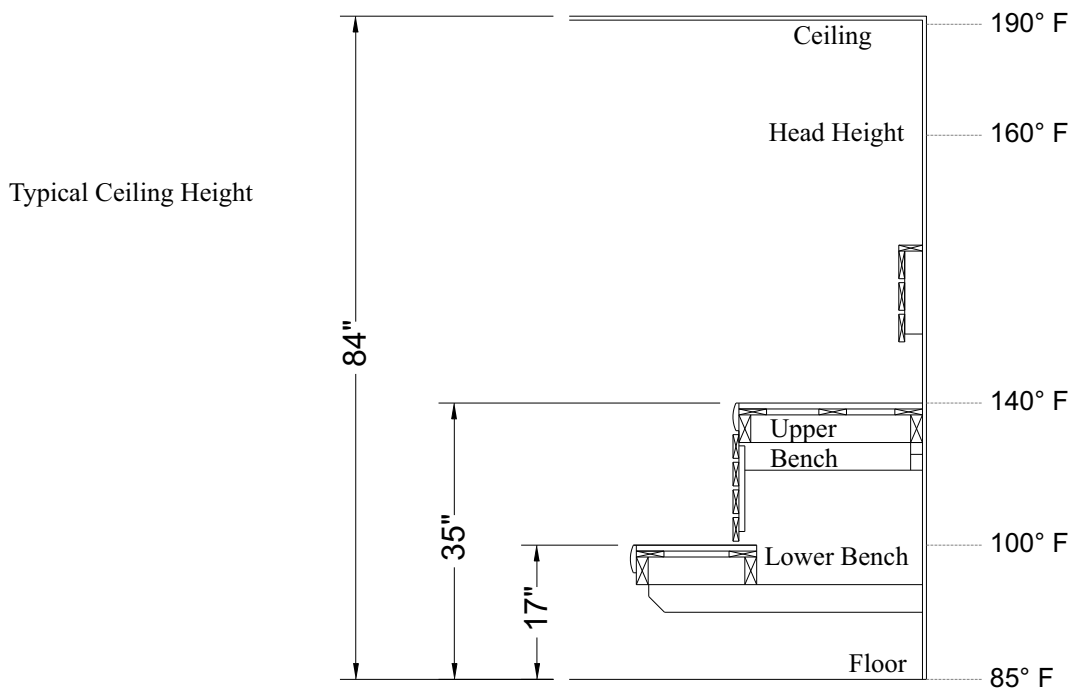

Typical Ceiling Height

SECTION 15: TROUBLESHOOTING

Control will Run but No Heat - Press the (reset) high limit switch on the back right side of heater.

Slow Heat Time or High Limit Tripping - Check rock placement, they will break down over time and reduce the air flow in the heater. Refer to Diagram 10 for proper rock installation. Discard all rocks under the size of 2" pieces. Call the number below to order more rocks if needed.

CAUTION: Use only a contactor approved for 250,000 endurance Cycles / ATTENTION: Utiliser uniquement un contacteur approuvé pour 250,000 cycles de fonctionnement

In the event of a fault occurring in the heater system (control panel, temperature sensor, etc.), the LED On/Off indicator will flash red on the control panel.

The fault error code will be displayed with a constant LED light or a flashing LED light under numbers 1-10. See the list below for fault codes.

Constant LED Fault Code (ones marked with "n/a" are not in use):

- 1 Temperature sensor not connected or it is faulty
- 2 n/a
- 3 Heater circuit board overheated
- 4 One or more relay defective
- 5 n/a
- 6 n/a
- 7 Temperature sensor
- 8 n/a
- 9 Clock disconnected
- 10 Power supply to clock disconnected

Flashing LED Fault Code

- 1 n/a
- 2 n/a
- 3 n/a
- 4 Temperature sensor faulty
- 5 Problem with device connection
- 6 n/a
- 7 n/a
- 8 Too many temperature sensors connected
- 9 n/a
- 10 n/a

LED Flashes Red during a fault

1 - 10 Indicates the fault code

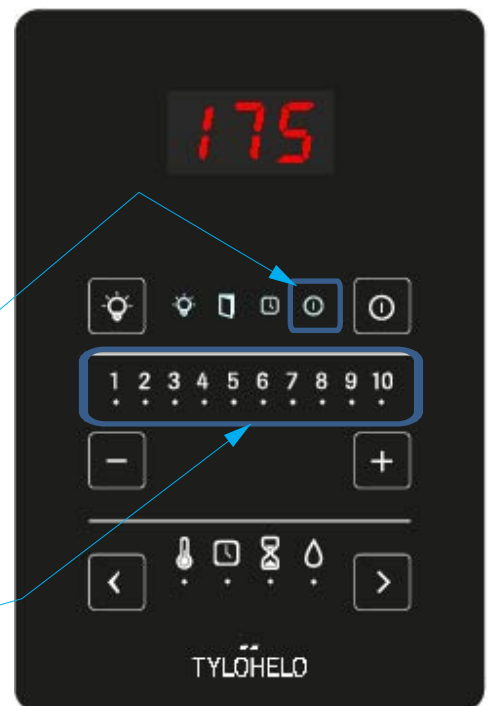

For troubleshooting or service questions call 1-888-780-4427 and ask to speak with service. Prior to calling, please have the Model and Type number available. You may also email us at