

21' X 19' DOUBLE GARAGE METAL SHED

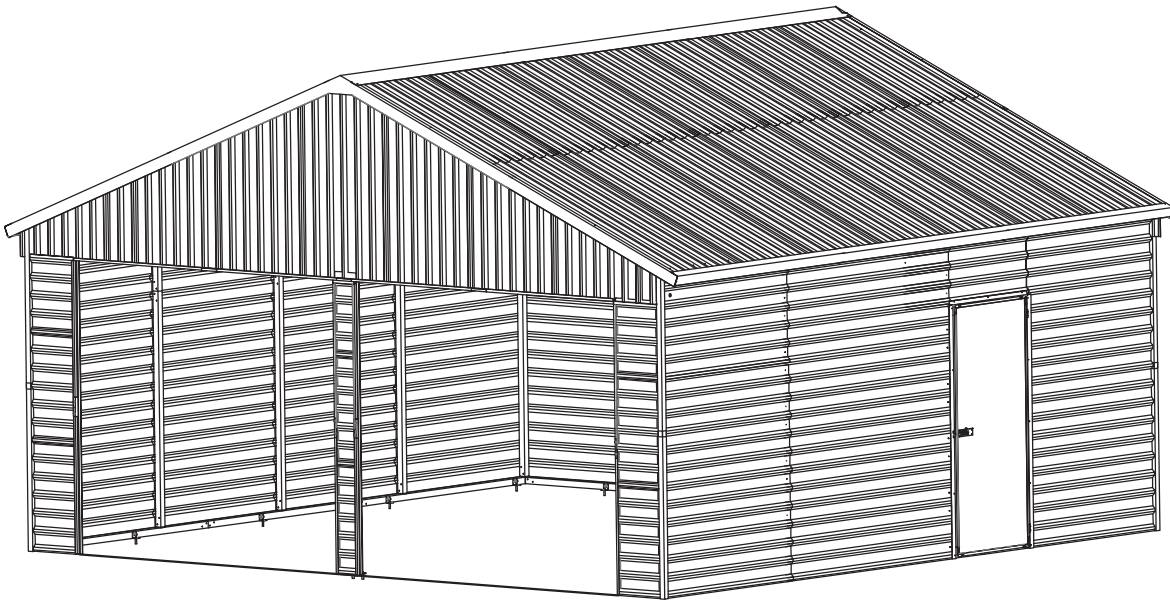

⚠ WARNING

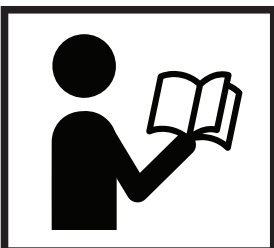

This structure is intended for temporary outdoor storage use only. It is not designed to withstand heavy snow and wind loads and does not come with engineering drawings. To ensure suitability for your specific weather needs, it is your responsibility to verify their appropriateness for your intended use and local weather conditions, especially in areas prone to severe weather.

- Please read and understand the product manual completely before assembly
- Check against the parts list to make sure all parts are received
- Wear proper safety goggles or other protective gears while in assembly
- Do not return the product to dealer. They are not equipped to handle your requests.

Missing parts or have questions on assembly?

Please call: 1-877-761-2819 or email: cs@tmgindustrial.com

Important tips

Dear user:

Hello!

In order to offer you a better use experience, we recommend that after the installation of the product, you shall carry out anti-rust protection treatment for the cutting end directly exposed to the air, the paint scratch and the surface zinc layer damage caused during the installation process. Due to the limitation of shipping conditions, we cannot provide you with flammable and explosive products such as antirust paint or antirust oil. Please purchase them locally or contact the dealer. After antirust treatment, the service life of the product can be effectively extended.







Manufacturer
January 2023

CONTENTS

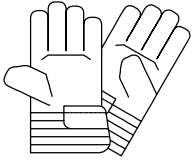
1. Before You Start	4
2. PartList.....	5-7
3. Analysis Diagram.....	8
4. Frame Assembly.....	9-23
5. Panel Assembly.....	24-39
6. Door Assembly.....	40-42
7. Shed Assembly.....	43-45
8. Install The Side Door on The Left.....	45-55

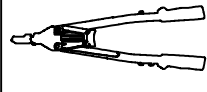
BEFORE YOU START

Items Required:

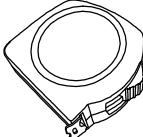





























Safety Gear				
	gloves	Safety Glasses	Shoes	Riveting Gun
Tools				
	Power drill	Screw driver	Pencil	Tape Measure

- Clear a working area to allow access on 4 sides. A raised work surface will make assembly easier.
- Please choose a dry and calm day to start assembly. Do not attempt installation in rainy or windy day.
- Keep roof clear of leaves and snow with long handled, soft-bristled broom. Heavy amounts to snow on roof can damage building, making it unsafe to enter.
- All parts are identified so when working through the instructions page by page the diagrams show where each part is positioned.
- Before starting, to avoid any accidental injury, we recommend the use of gloves to protect your hands, safety glasses to protect your eyes and shoes or boots to protect your feet.
- Some holes have been pre-punched, using self-tapping screws to fix.
- Please keep children away from your construction site.
- Most assembly can be completed by one person, assistance may be needed when you reach the erection stage.
- Cleaning should be performed as often as is required to remove any dirt, salt, and pollutants.
- Please note: Some local government authorities have rules & regulations on shed installation and you may need approval to erect this shed.

















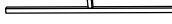
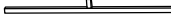

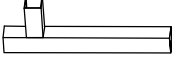



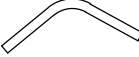

STEPS:

1. Unpack all components from the carton and lay outside your work area and check parts against the part list on the next page.
2. Work through assembly instructions Page by Page.
3. Use anchors to fix the garage to the ground.
4. Clean up all metal pieces, rivets and screws.



PART LIST

Picture	Name	QTY	Specification mm	Picture	Name	QTY	Specification mm
	P11	8	1600*880		P12	4	1600*880
	P21	10	1490*880		P22	4	1490*880
	P3	1	1490*570		P41	2	1965*880
	P42	1	1965*880		P51	4	430*880
	P52	2	430*570		P61	2	210*880
	P62	1	210*570		P7	14	2060*880
	P8	14	1520*880		P91	2	1460*880
	P92	1	1460*880		PD1	1	1910*880
	PA1	2	385*190		PA2	2	725*880
	PA3	2	1060*880		PA4	2	1395*880
	PA5	2	1550*880		PB4	2	1395*880
	PB3	2	1060*880		PB2	2	725*880
	PB1	2	385*190		P23	1	1490*880
	F1	6	1923		F2	4	1330
	F3	8	1118		F4	1	210

PART LIST

Picture	Name	QTY	Specification mm	Picture	Name	QTY	Specification mm
	F5	2	806		F6	1	1860
	F7	1	1860		F8	1	856
	F9	2	1160				
	A11	2	1998		A12	2	1998
	A21	2	1998		A22	1	2100
	A31	2	2100		A32	2	320
	A33	2	730		A34	1	1885
	A4	18	1895		A5	2	905
	A6	3	2150		AS2	10	1030
	AS4	5	1344		AS3	10	2050
	A7	1	1835		A8	2	1225
	B1	4	1490		B2	2	270
	B3	12	1432		B4	12	1467
	M1	2	1930		M2	1	1380
	L1	8	1780		L2	6	1979

PART LIST

Picture	Name	QTY	Specification mm	Picture	Name	QTY	Specification mm
	Z1	4	1600		Z2	2	430
	W1	8	1280		T2	1	916
	R1	3	1992		T1	2	1930
	JA	11	150		S1	28	M5×13
	S12	1398	M5×20		S13	60	M5×50
	L3	18			L1A	6	
	LGG	2			S7	18	3.5×11
	S16	18	M4×12		MSA	2	150
	C3	30			C22	28	
	C52	6			C62	12	
	C72	14			SH1	2	
	S11	14	M8×80		H1	1	
	S15	4	M8×100		CG1	1	
	Waterproof tape	1			C12	4	



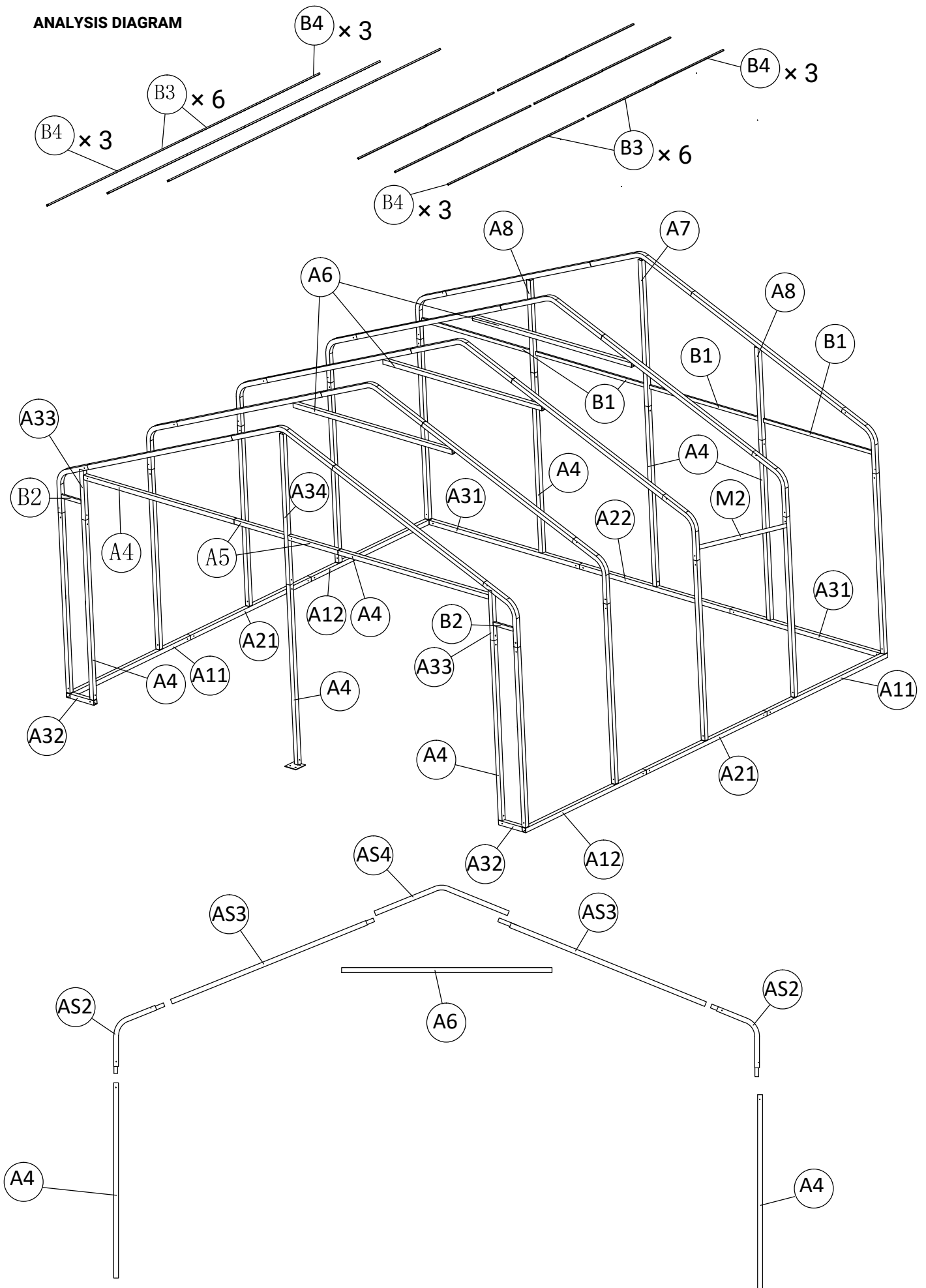

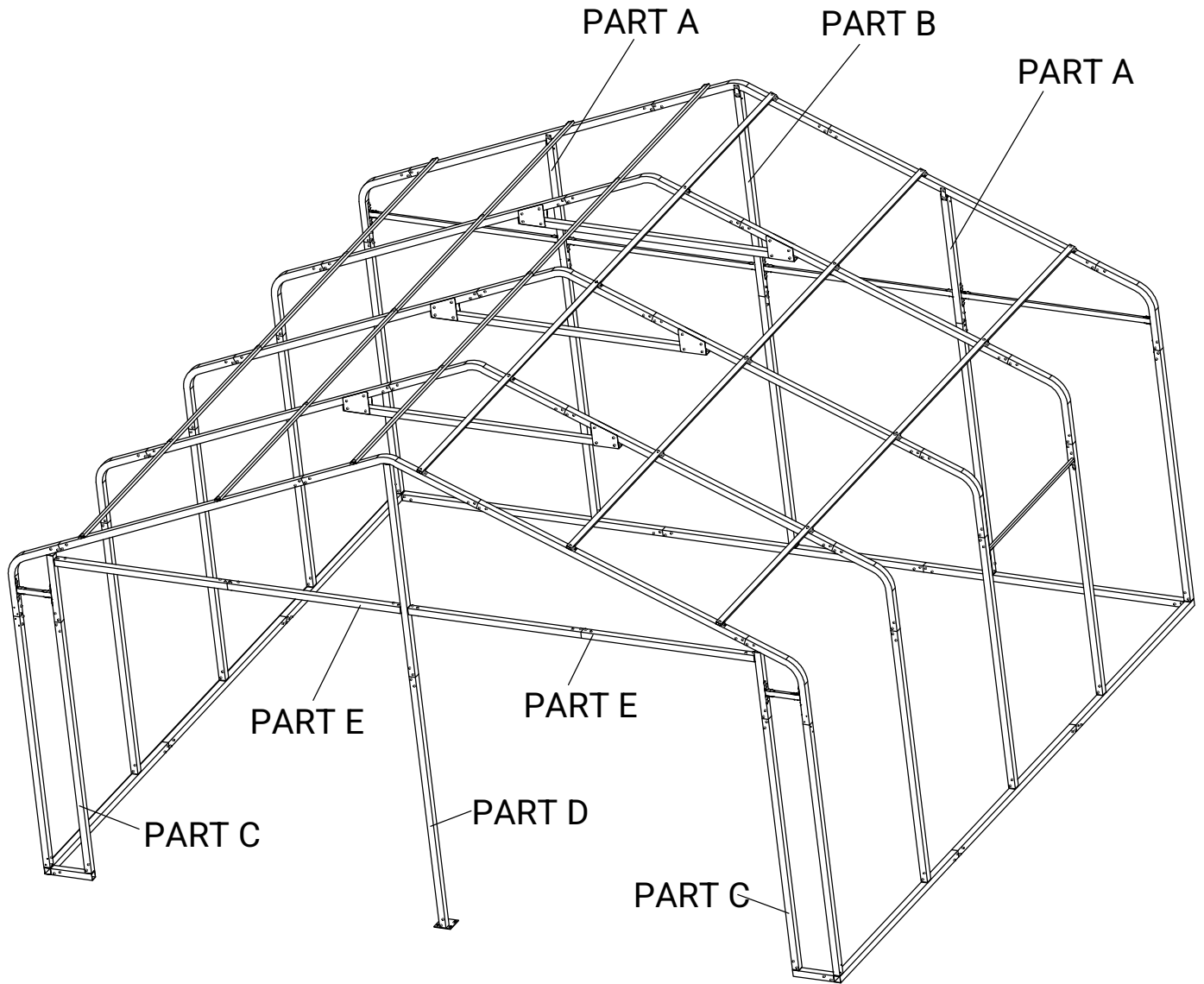

ANALYSIS DIAGRAM



FRAME ASSEMBLY



FRAME ASSEMBLY

	A4	8		A8	2		A33	2		A34	1
	A5	2		A7	1		S12	28			

when you install the square tube, it will be much easier to adjust the angel first.



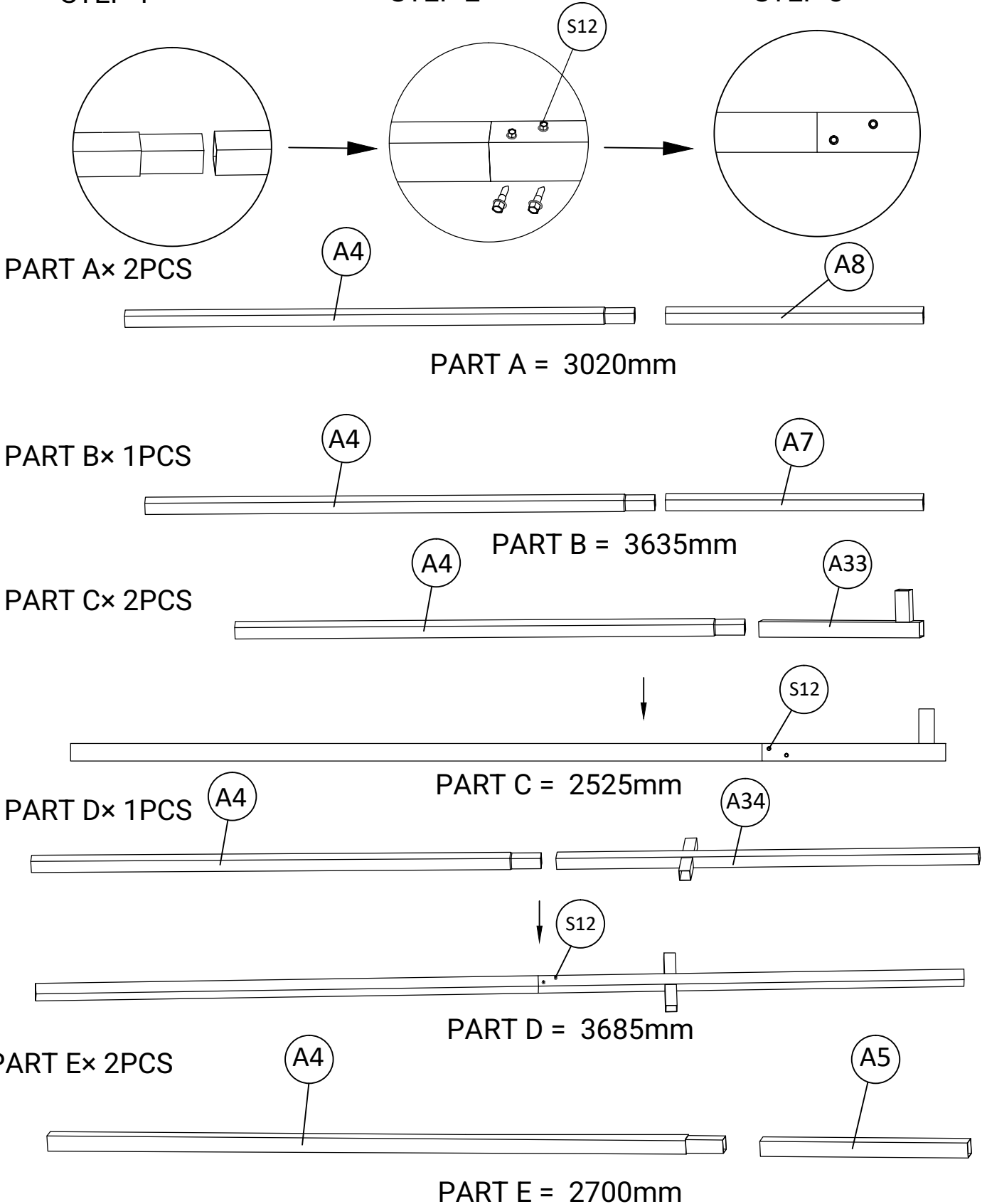

STEP 1

STEP 2

STEP 3



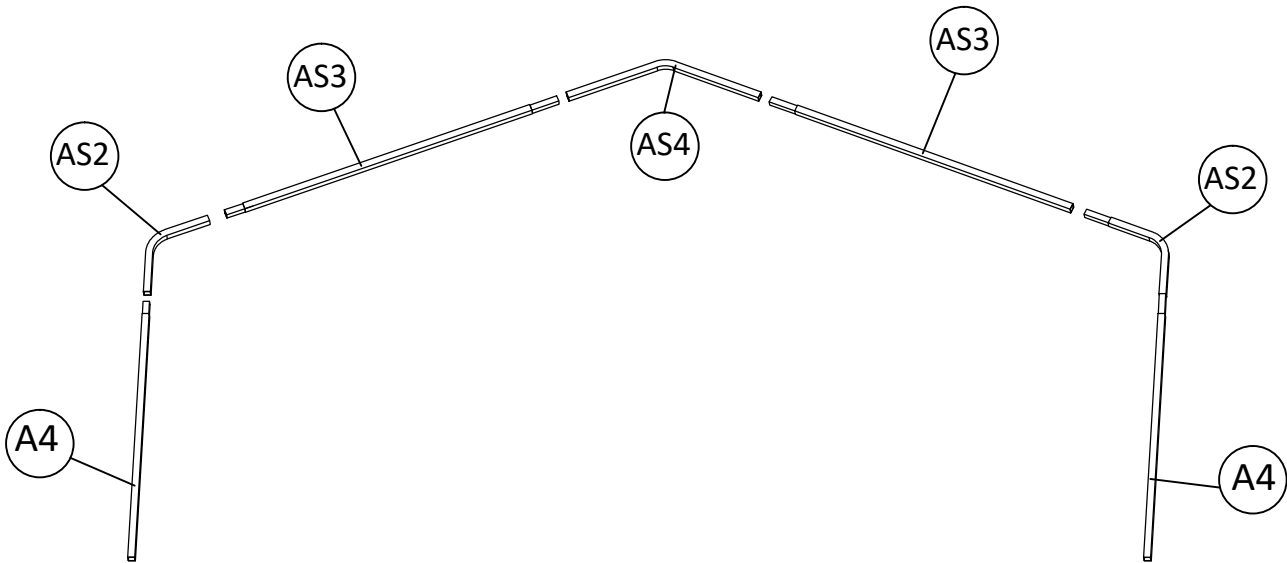

STEP 1

	A4	2		AS2	2		AS3	2
	AS4	1		S12	24			



STEP 2



	B1	1		C22	4		S12	16
--	----	---	--	-----	---	--	-----	----



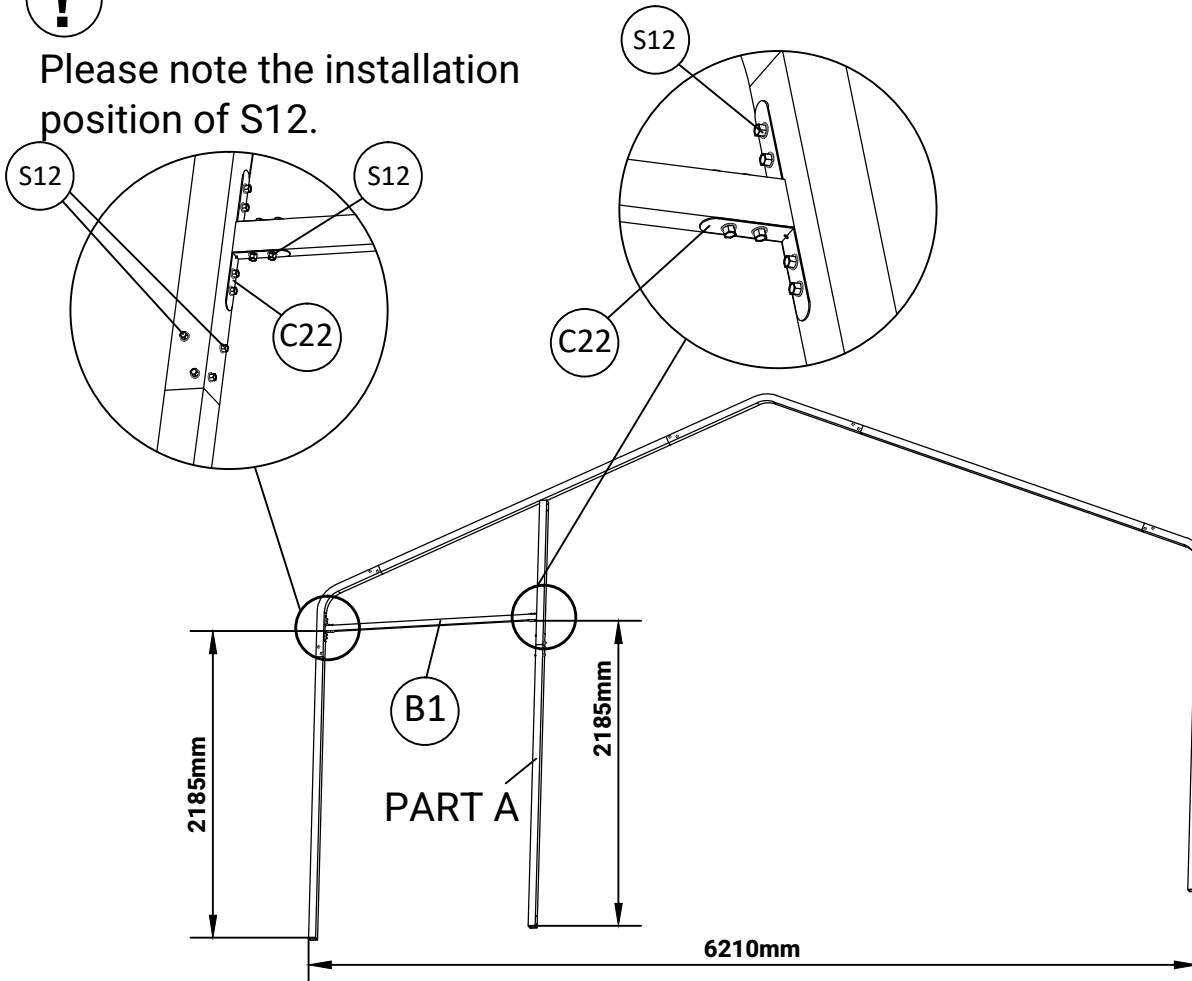

Please note the installation position of S12.



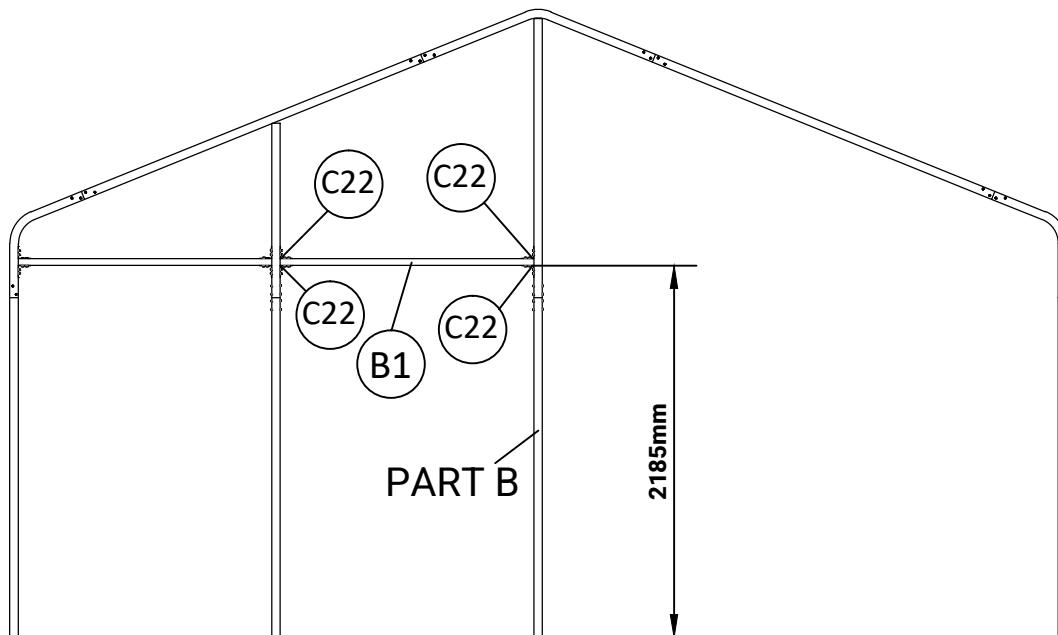

STEP 3

	B1	1		C22	4		S12	16
---	----	---	---	-----	---	---	-----	----



 Please note the installation position of S12.

STEP 4

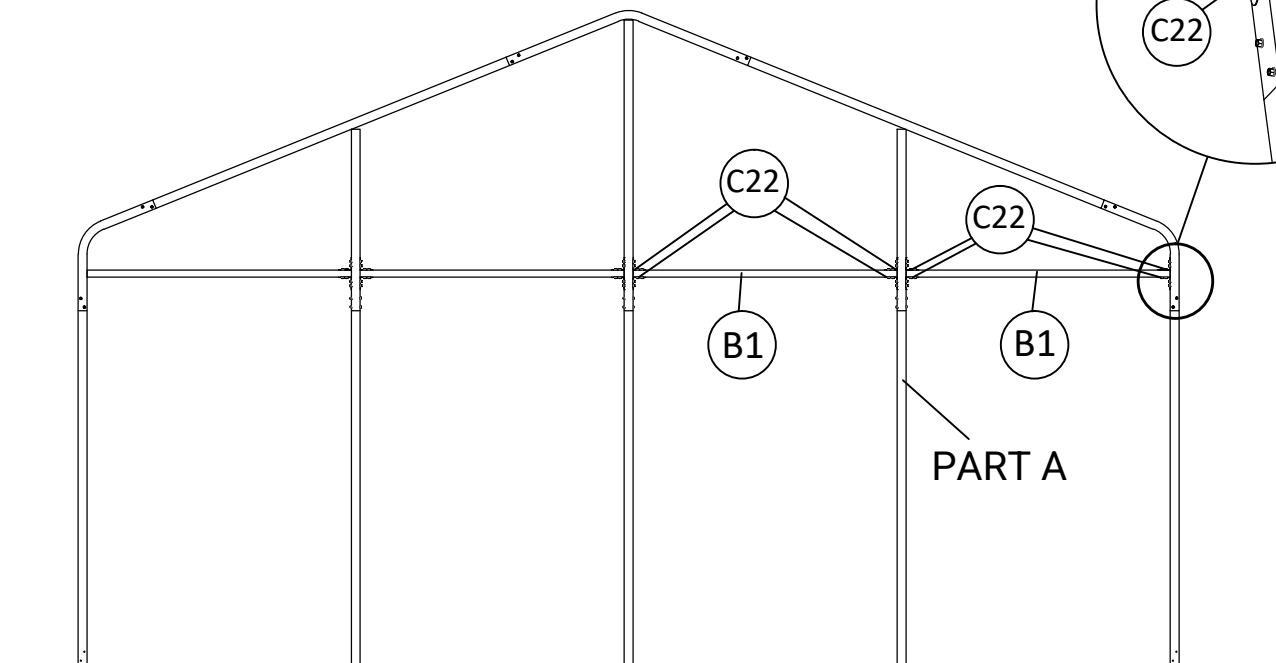
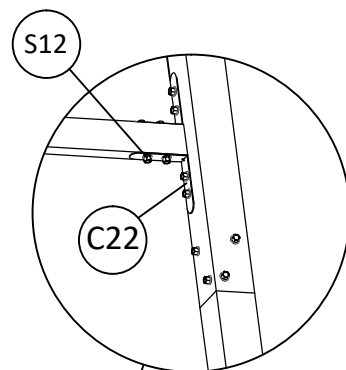

	B1	2		C22	8		S12	32
---	----	---	---	-----	---	---	-----	----



Make sure on the same level.

FRAME ASSEMBLY-Back Wall

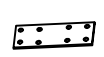

STEP 5

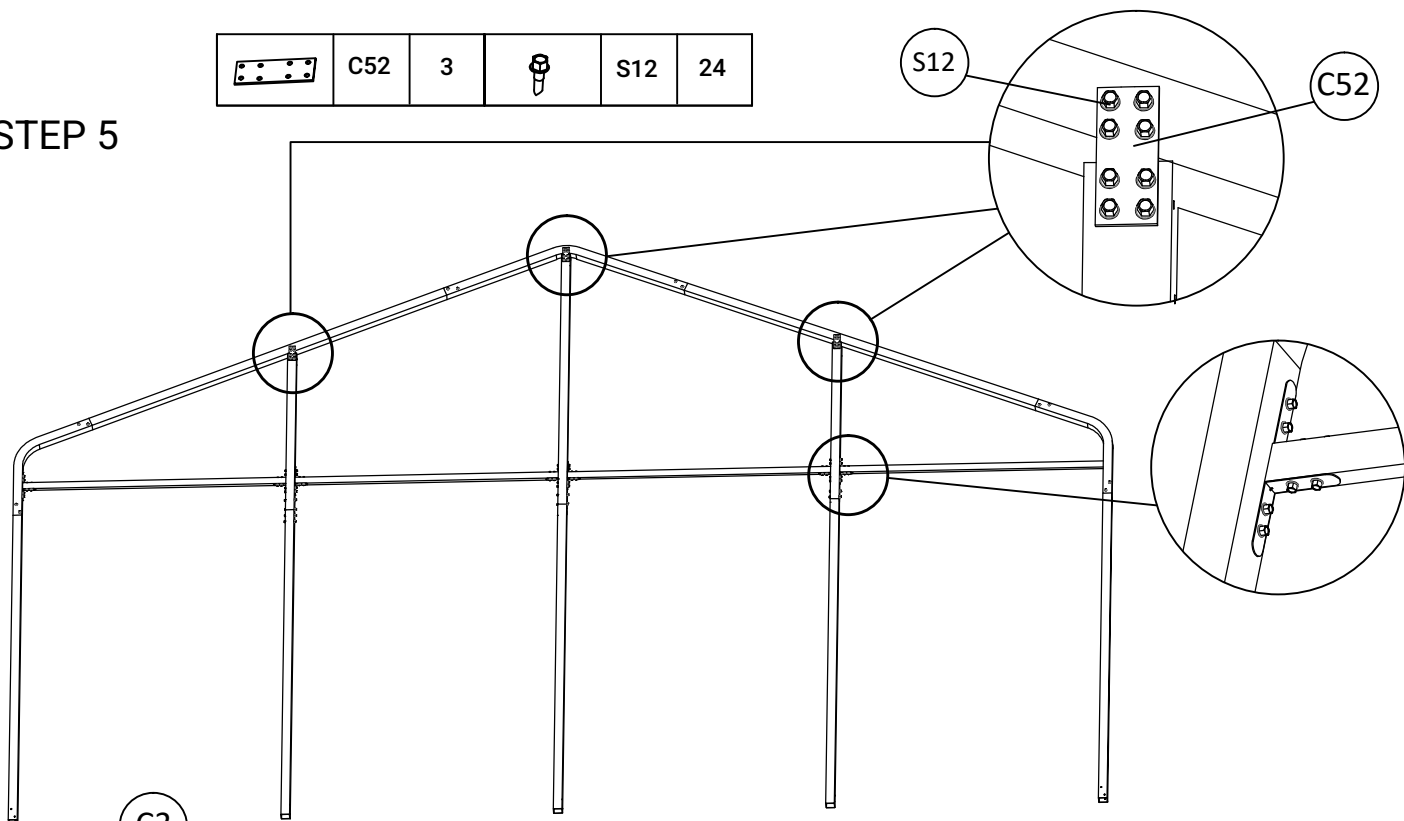
	C52	3		S12	24
---	-----	---	---	-----	----

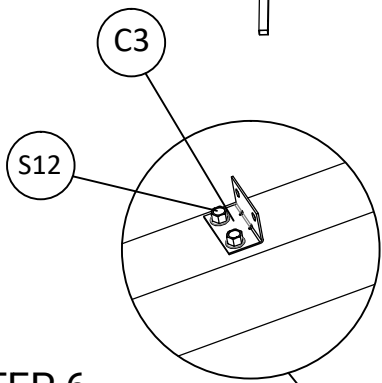

STEP 6





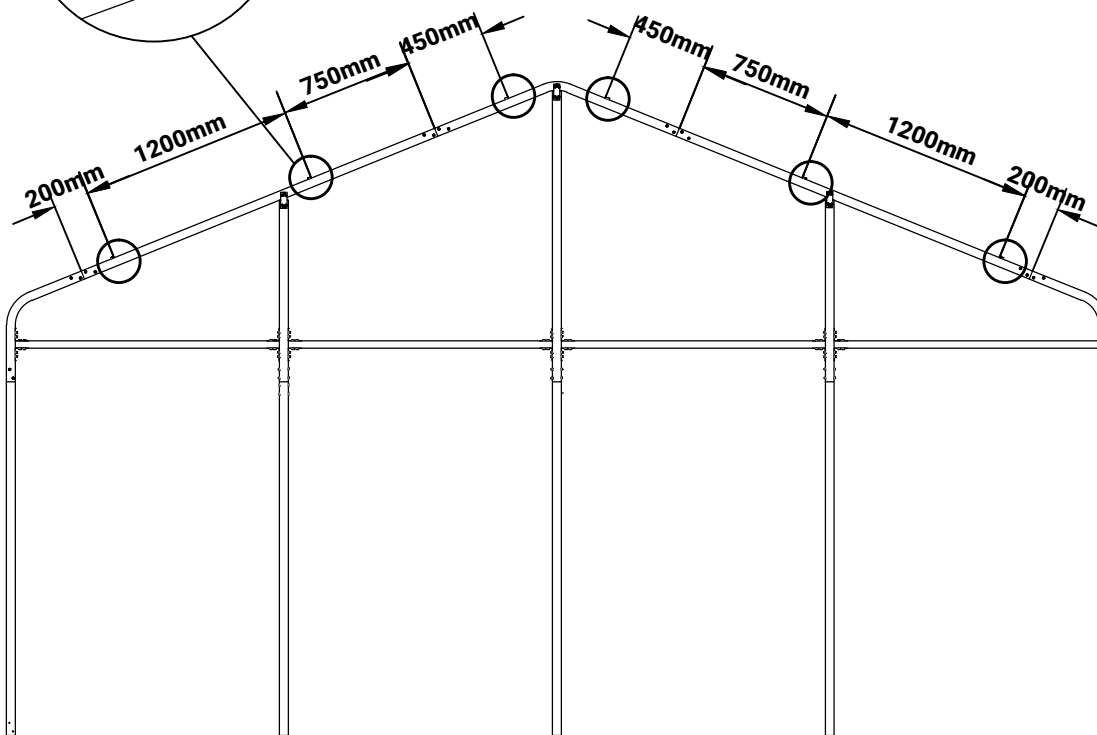

	C3	6		S12	12
---	----	---	---	-----	----



FRAME ASSEMBLY-Front Wall

STEP 1

	A4	2		AS2	2		AS3	2		AS4	1
	S12	24									

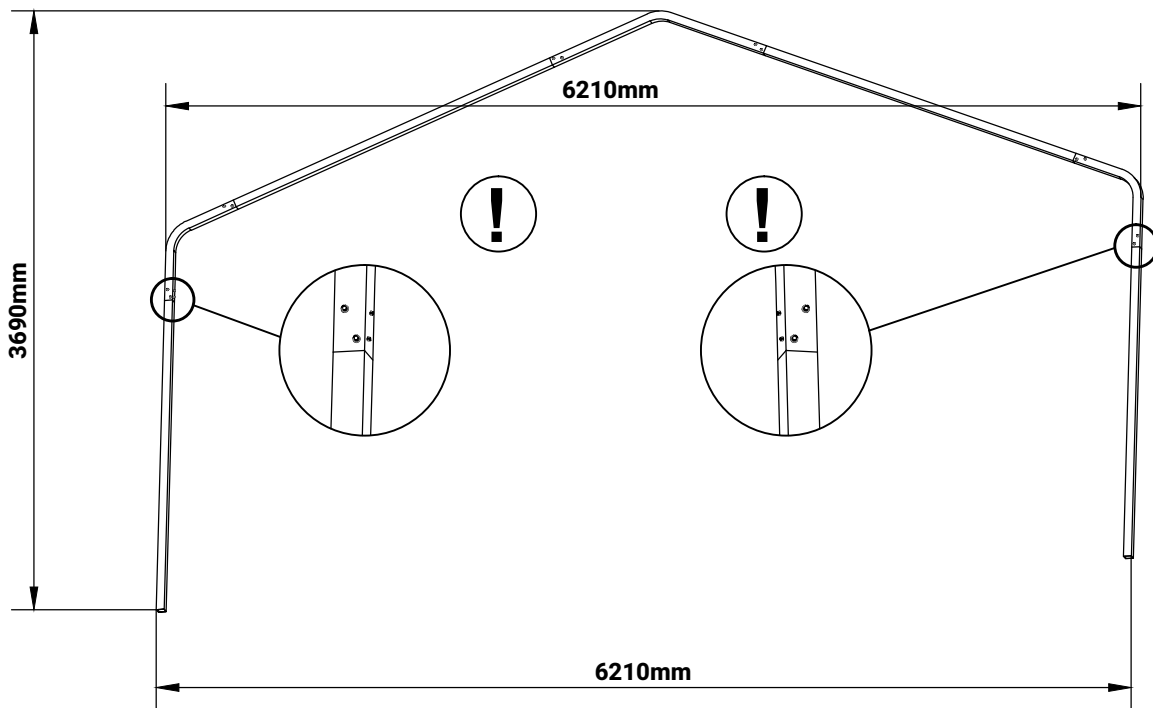
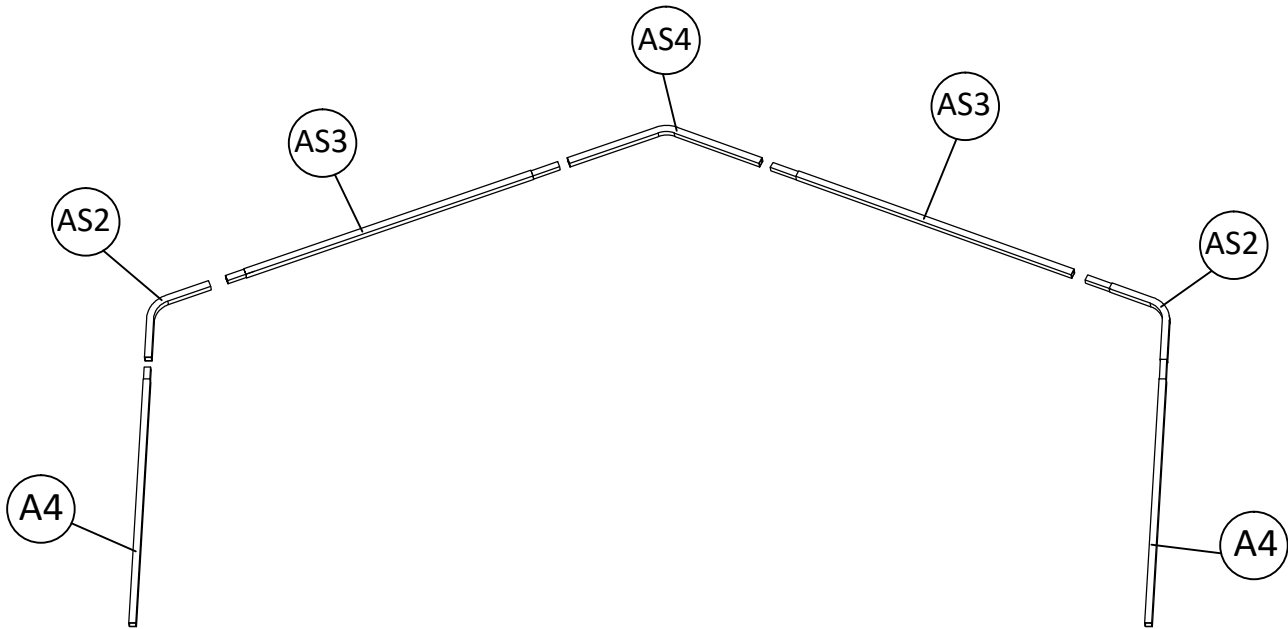

STEP 2



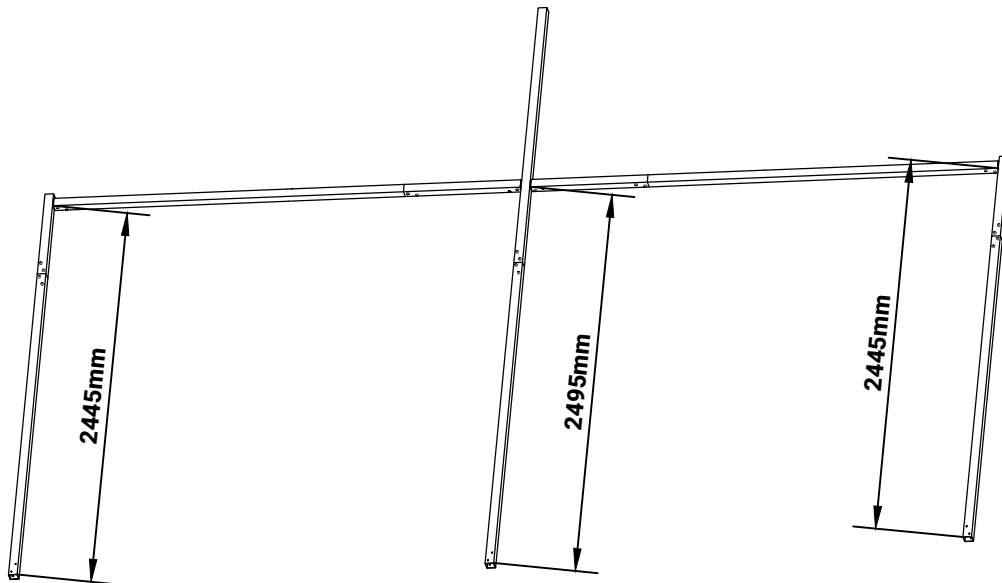
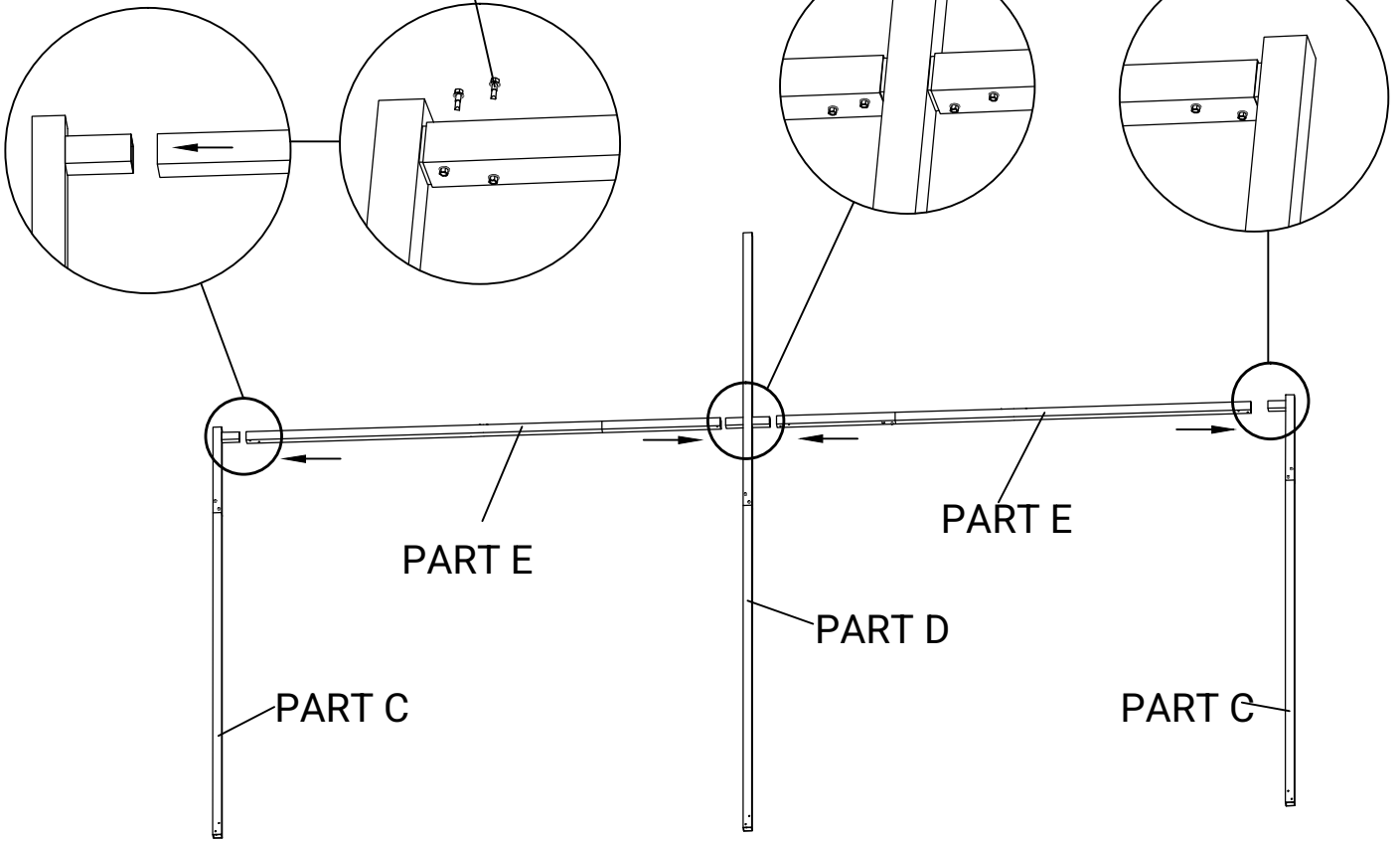

	S12	16
---	-----	----

S12





FRAME ASSEMBLY-Front Wall

STEP 3

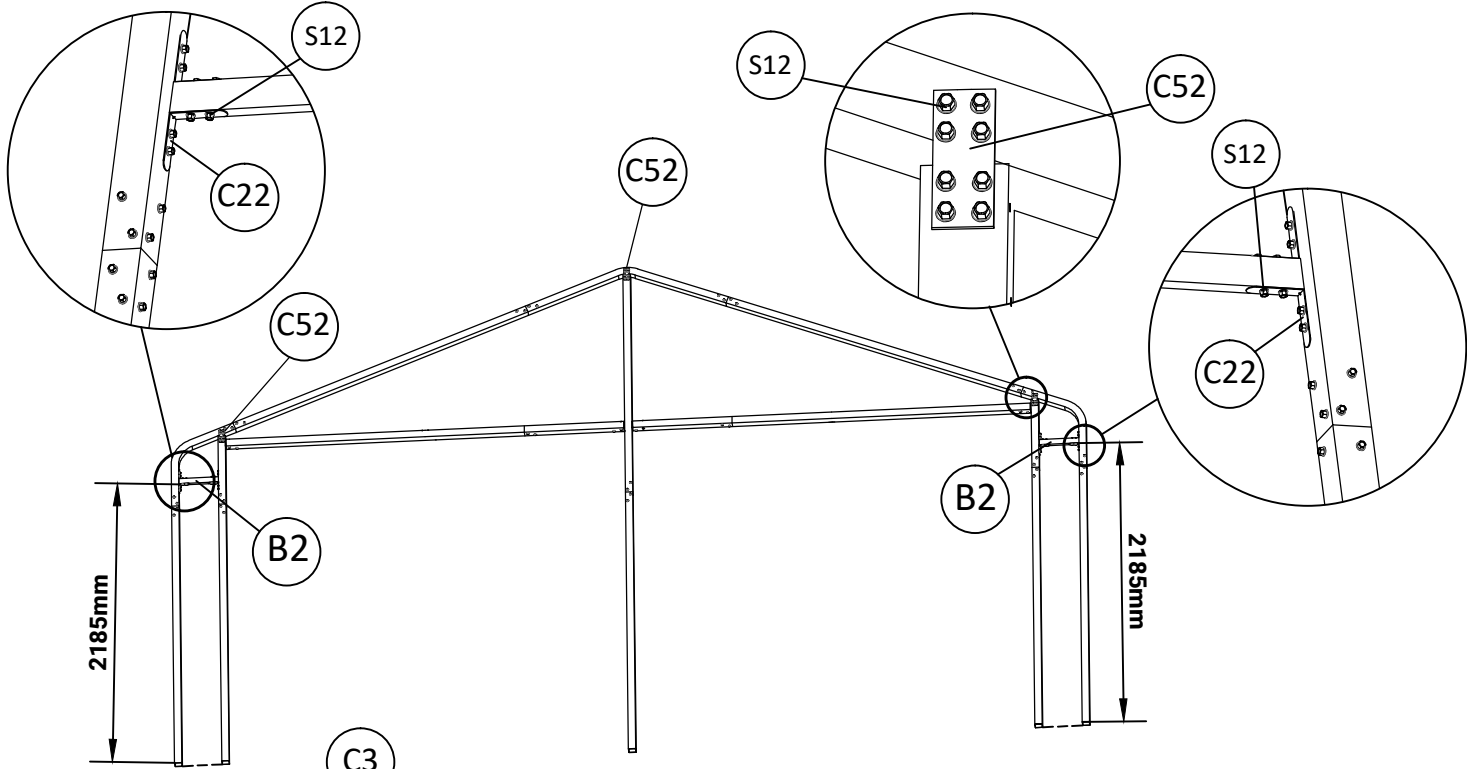
	B2	2		C22	8		C52	3		S12	56
---	----	---	---	-----	---	---	-----	---	---	-----	----





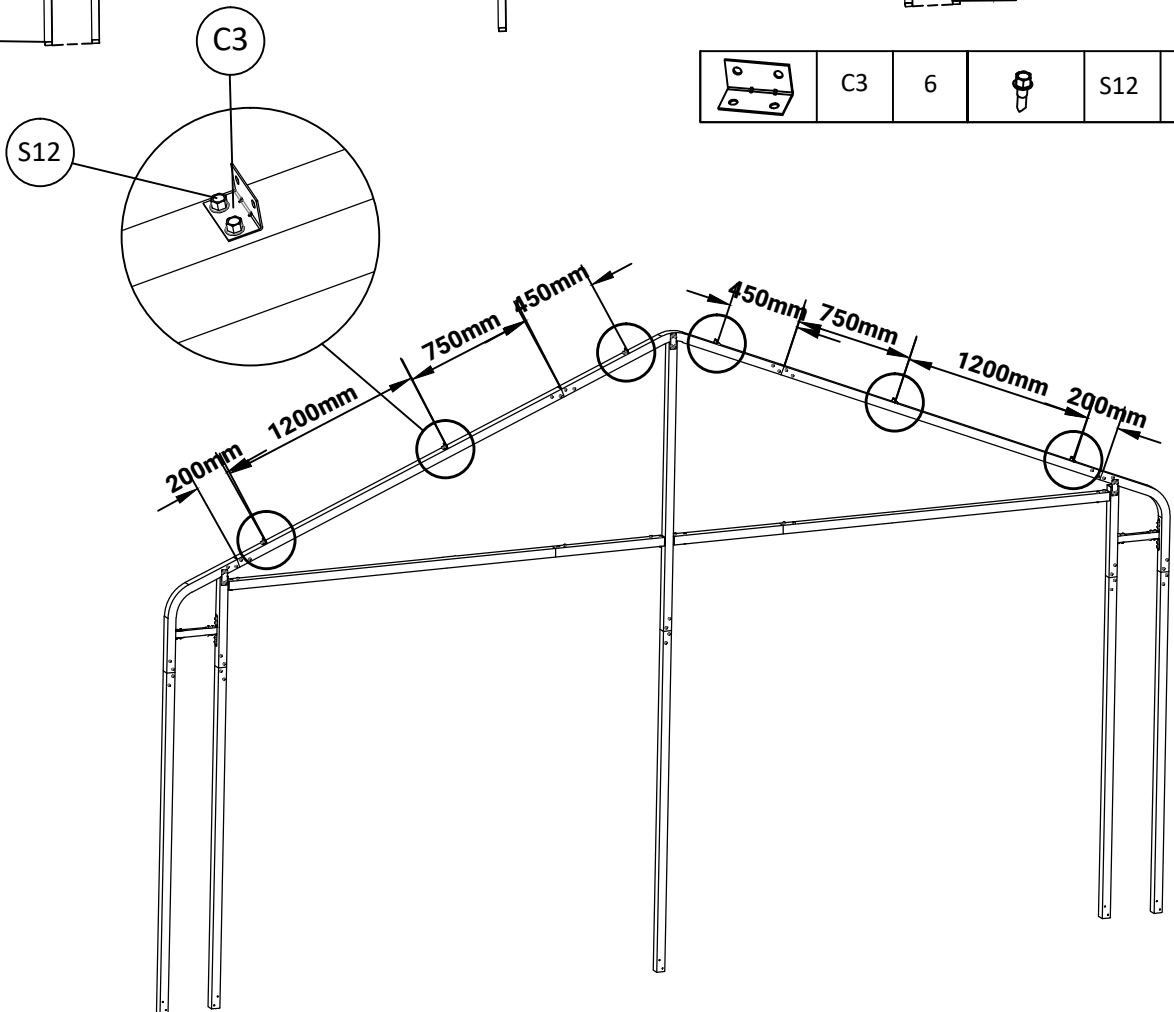

STEP 4

	C3	6		S12	12
--	----	---	---	-----	----



FRAME ASSEMBLY-Middle Part

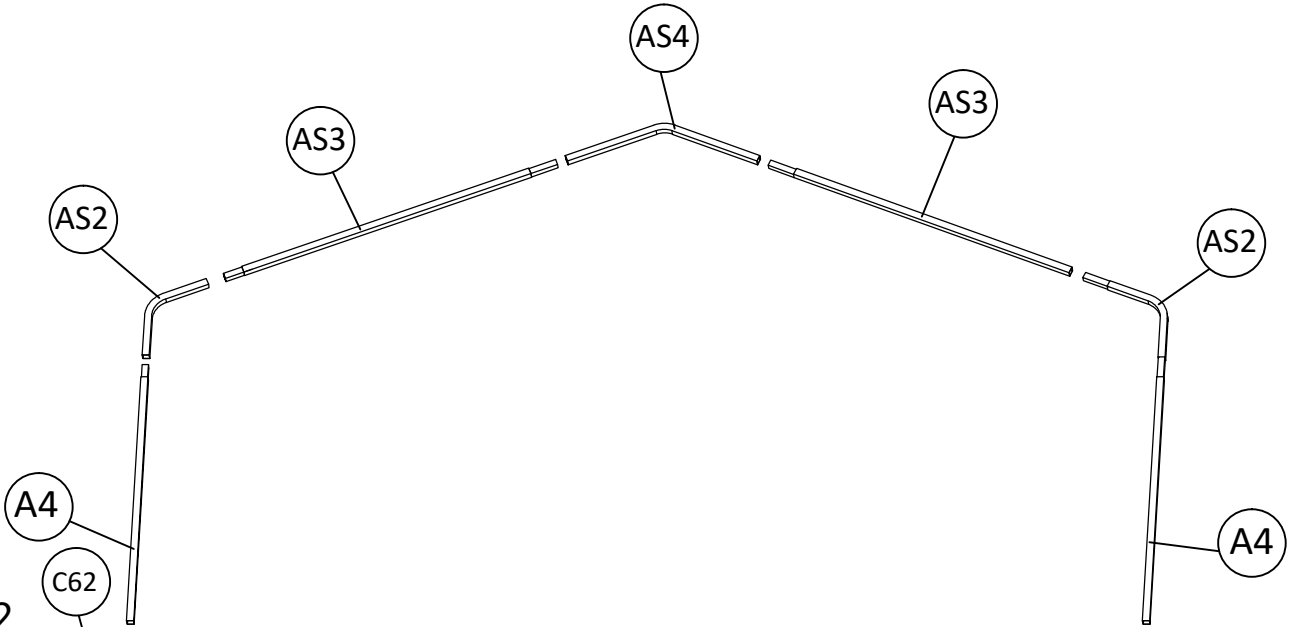

STEP 1

	A4	2		AS2	2		AS3	2		AS4	1
	S12	24									



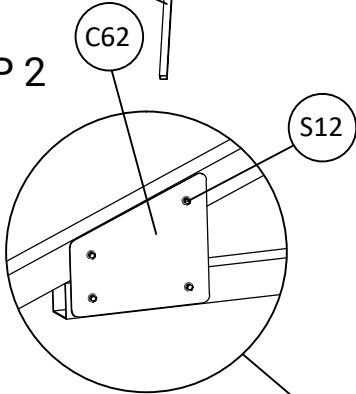

STEP 2

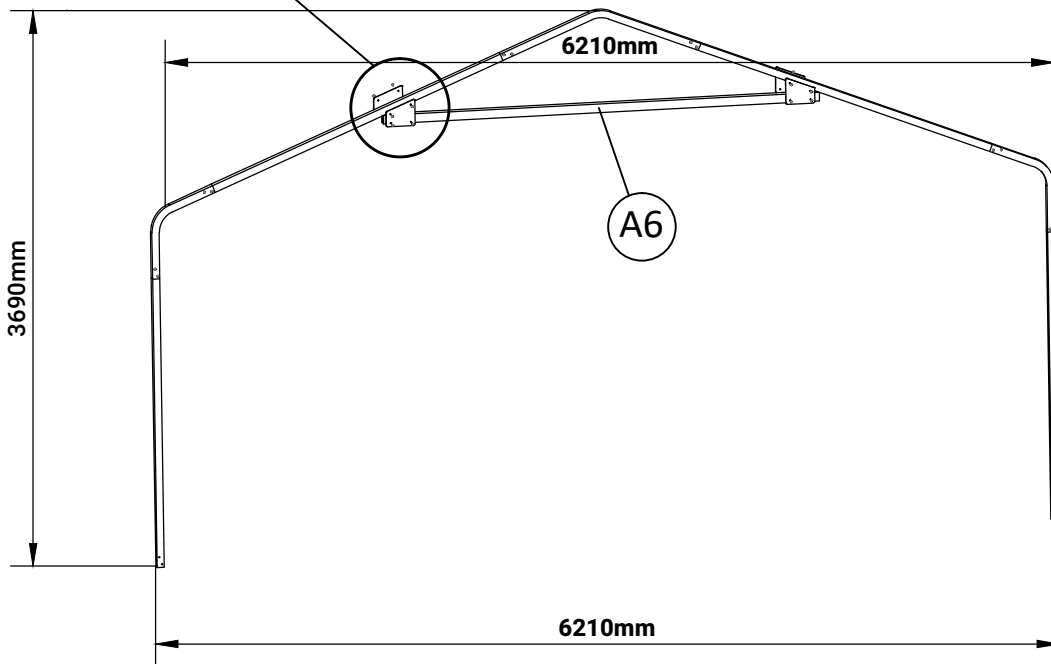

	C62	4		S12	16		A6	1
---	-----	---	---	-----	----	---	----	---



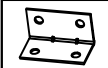



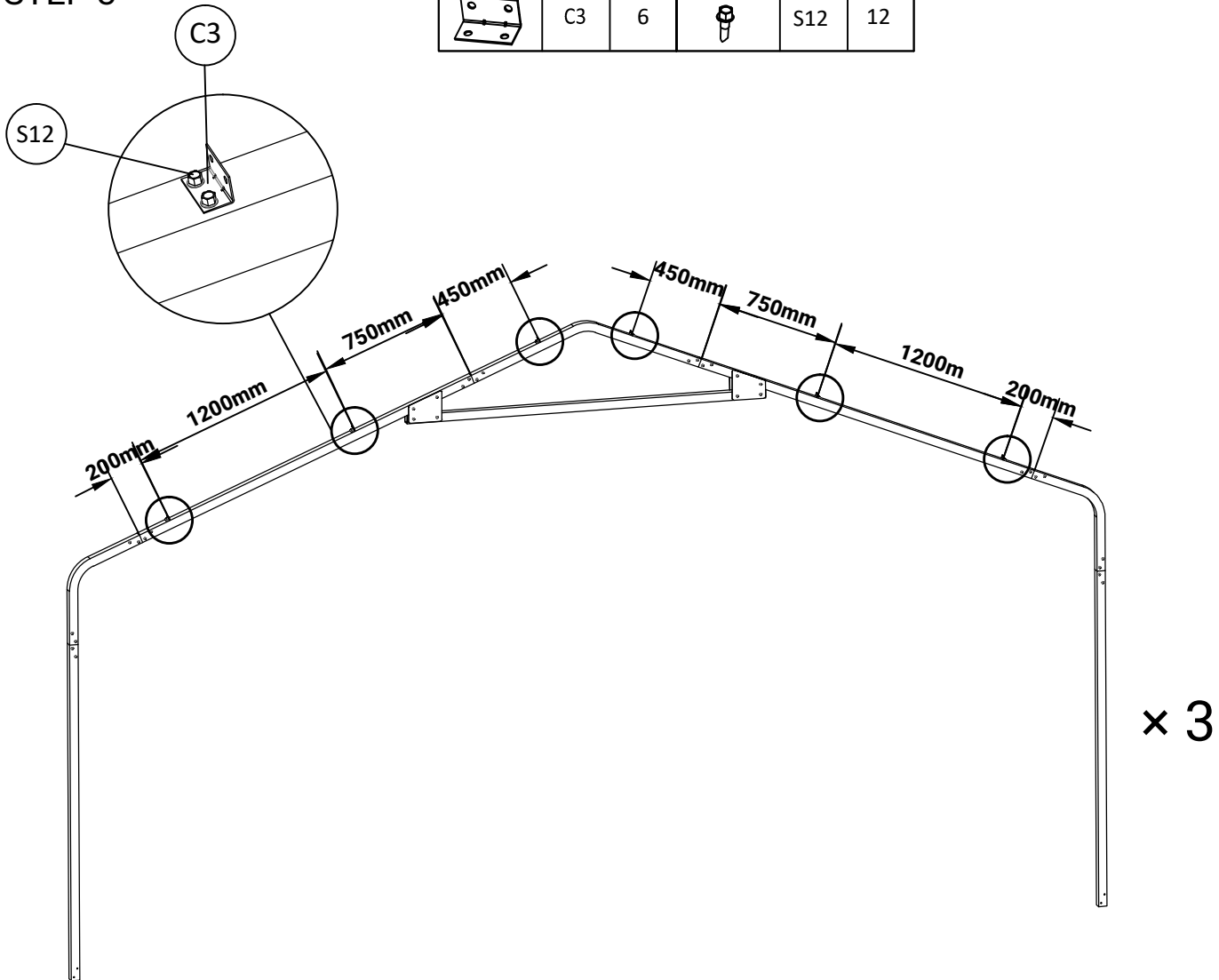

STEP 3

	C3	6		S12	12
---	----	---	---	-----	----



FRAME ASSEMBLY-Base

	A11	2		A21	2		A12	2		A31	2
	A22	1		A32	2		S12	40			

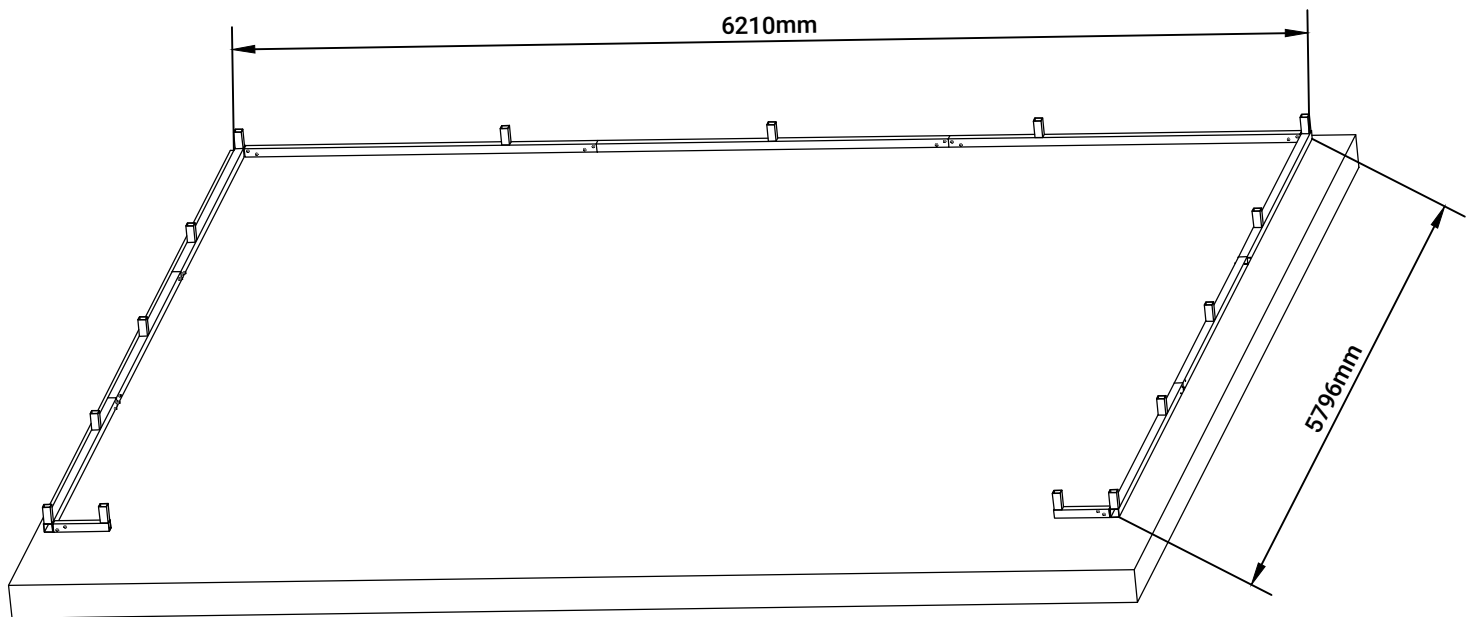
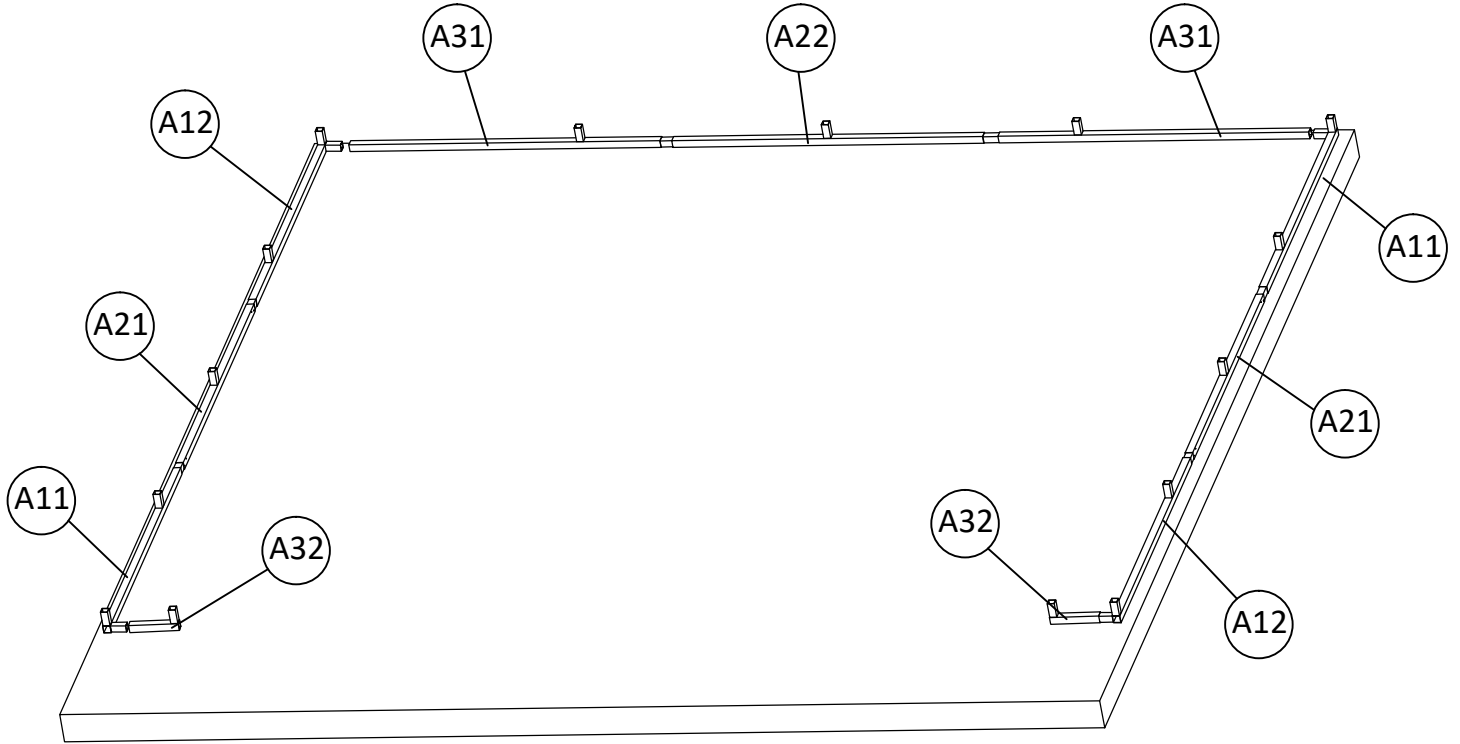

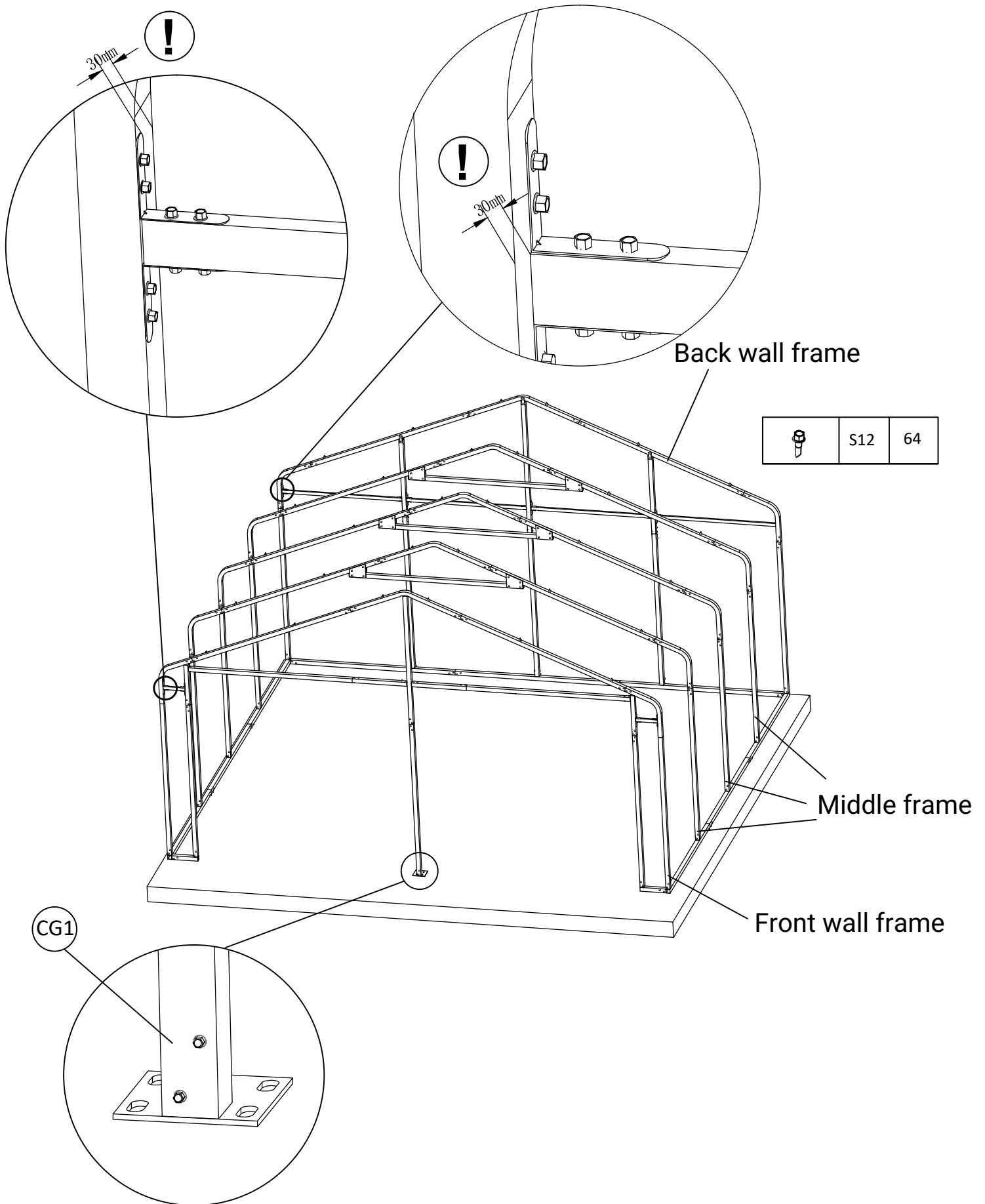

FRAME ASSEMBLY





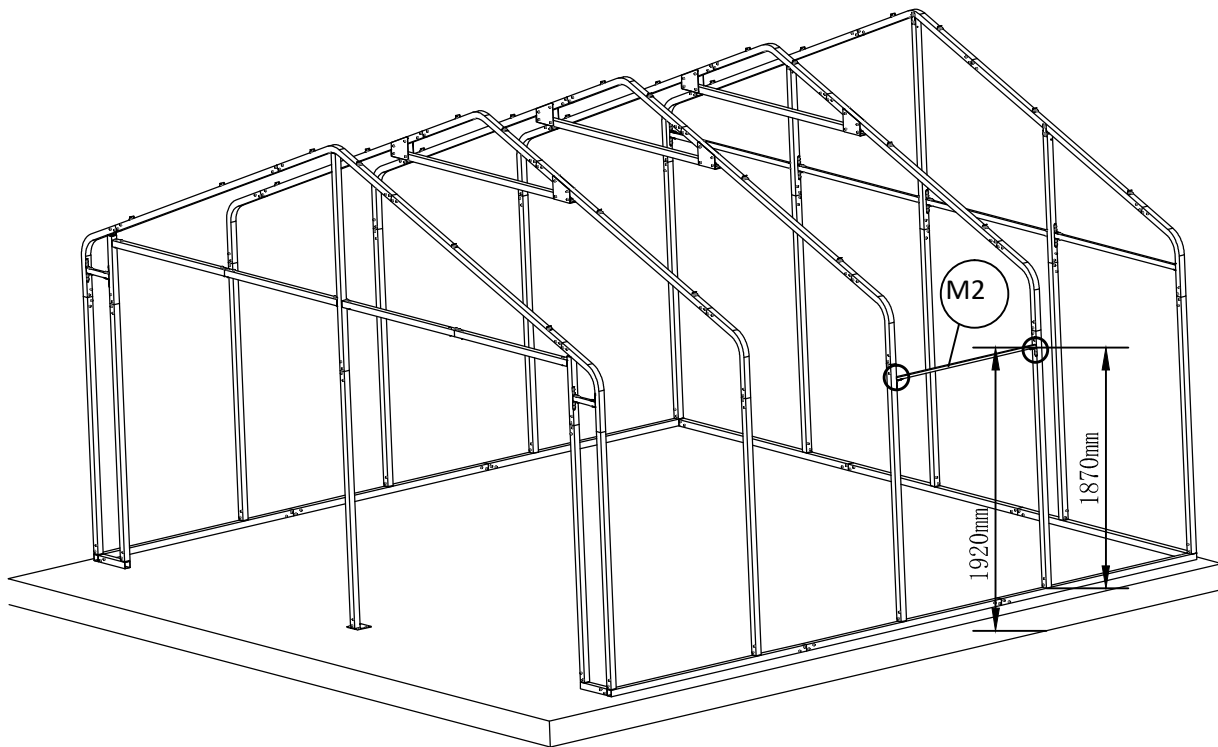
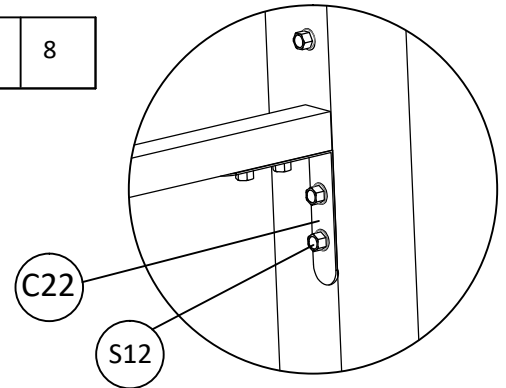

If you want to install the side door on the right, please follow the steps on page 20- 30.

If you want to install the side door on the left ,please follow the steps on page 44- 54.

	M2	1		C22	2		S12	8
---	----	---	---	-----	---	---	-----	---



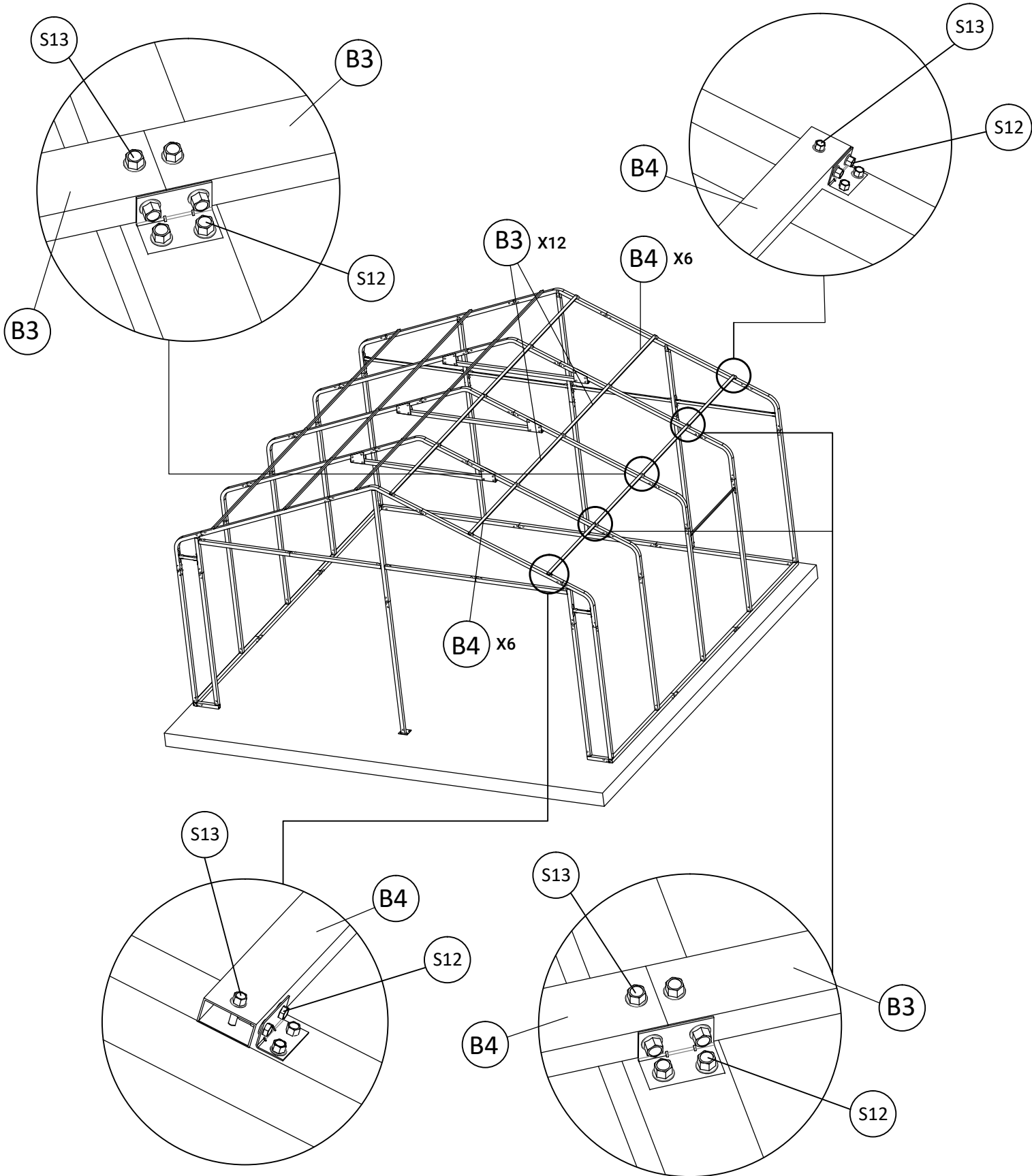

Frame Assembly - Beam Part

	B3	12		B4	12		S12	60		S13	48
---	----	----	---	----	----	---	-----	----	---	-----	----



FRAME ASSEMBLY

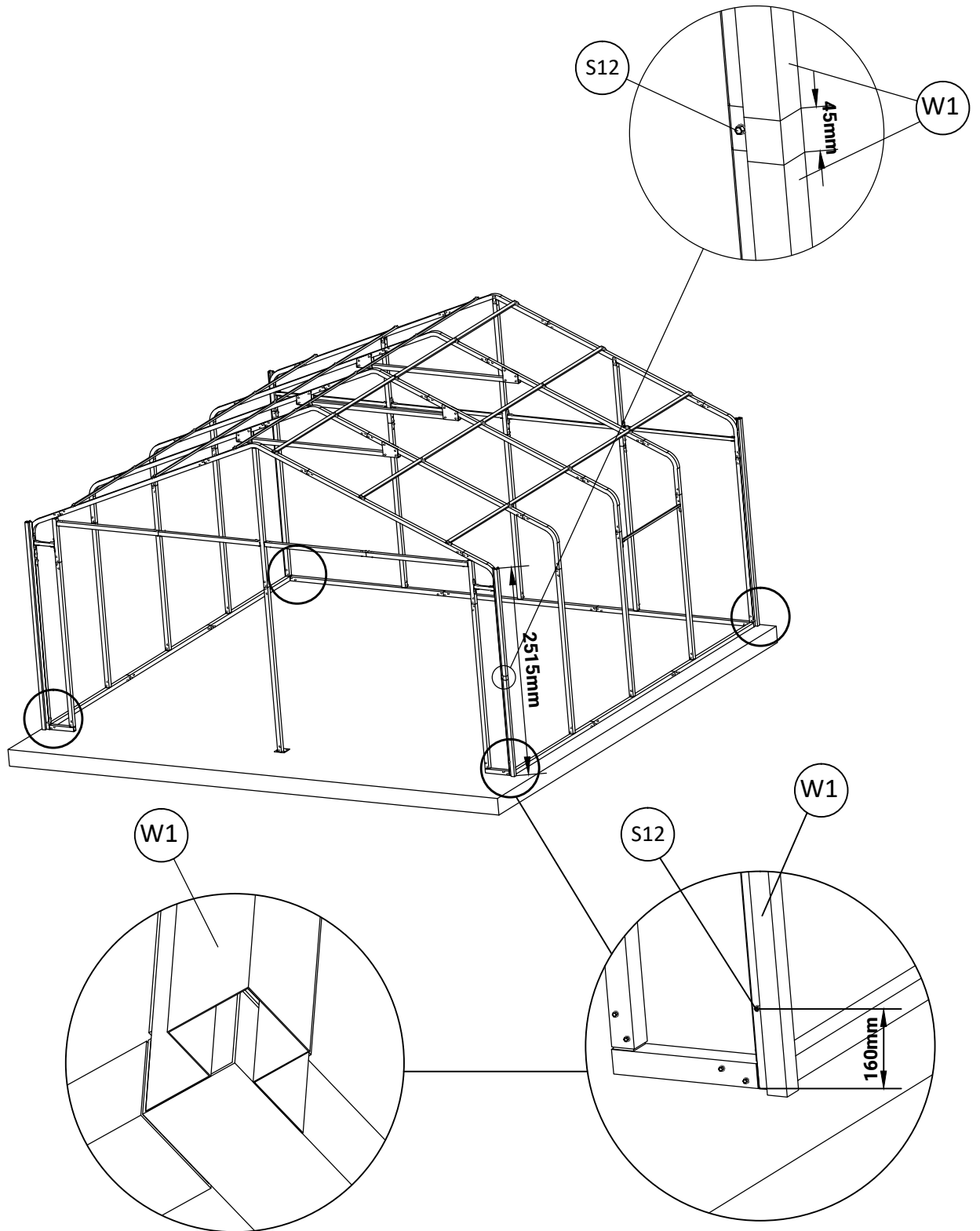

	W1	8		S12	16
---	----	---	---	-----	----



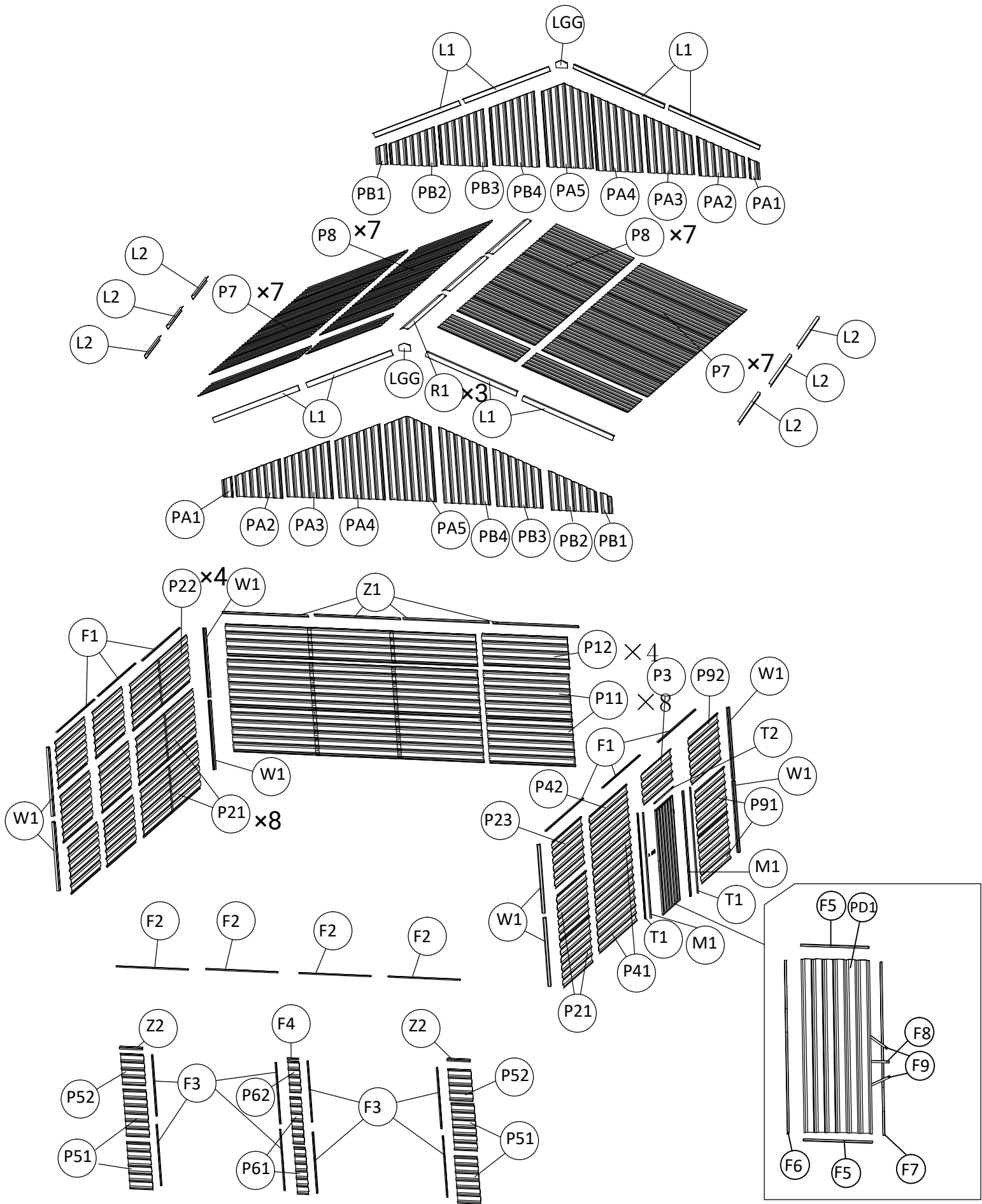

FRAME ASSEMBLY



Panel Assembly - Back Wall

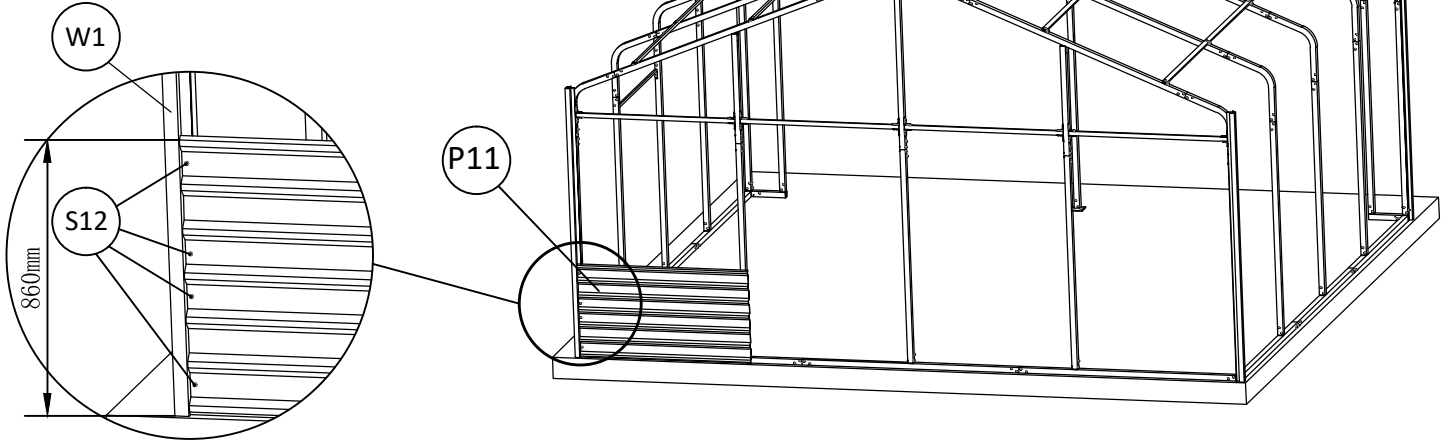

	P11	1		S12	4
---	-----	---	---	-----	---



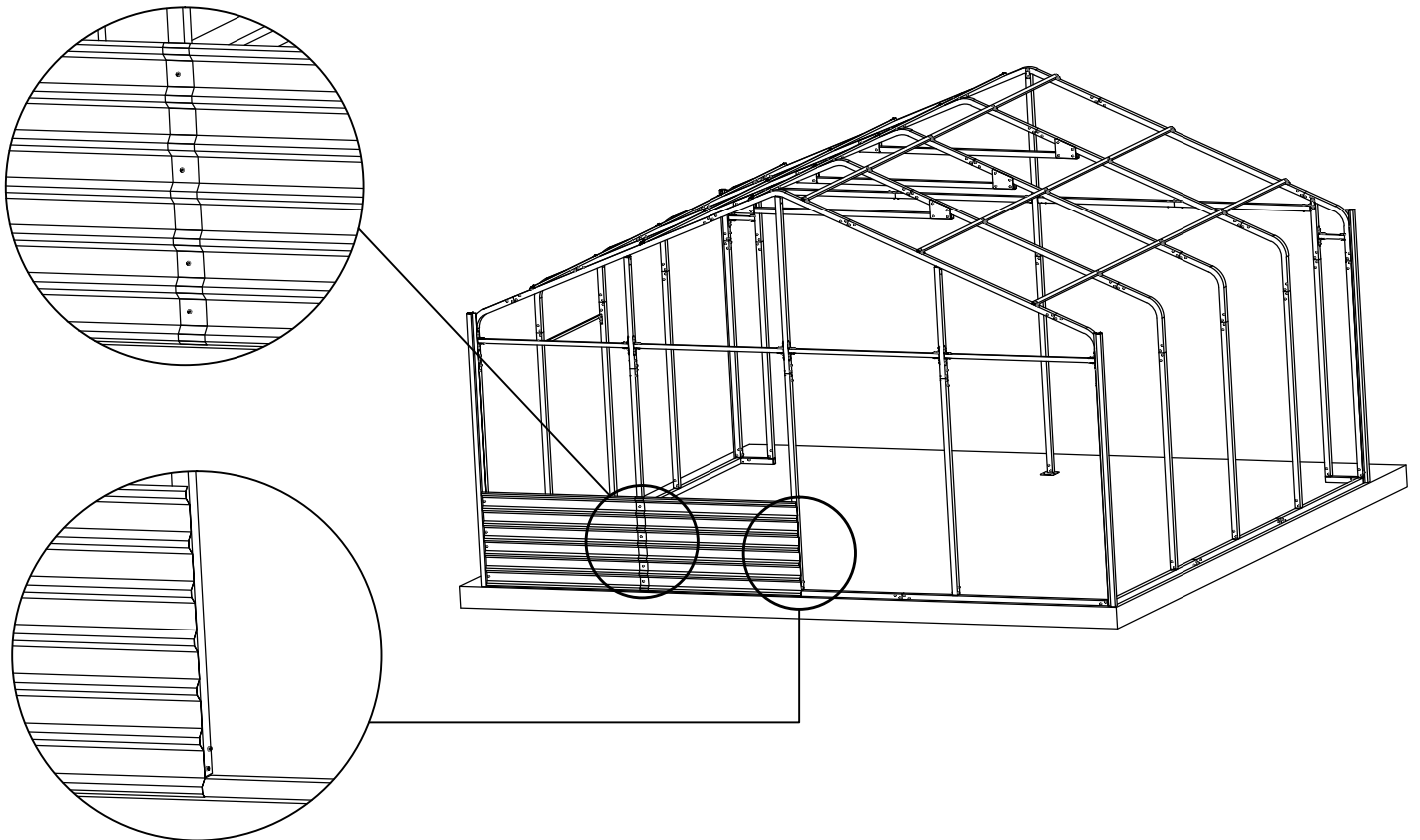

	P11	1		S12	4
--	-----	---	--	-----	---

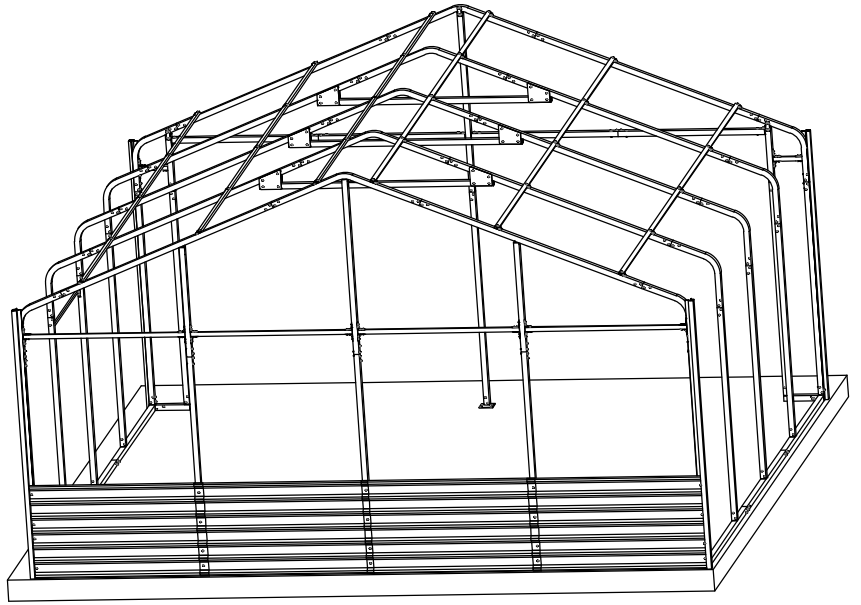

Panel Assembly - Back Wall

	P11	2		S12	12
---	-----	---	---	-----	----





	P11	4		S12	20
--	-----	---	---	-----	----

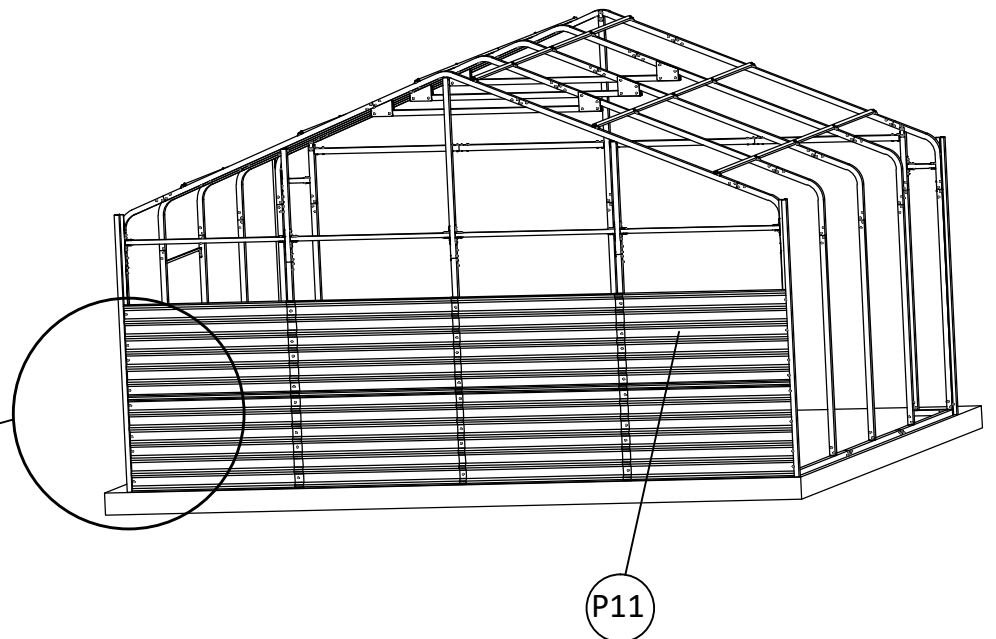
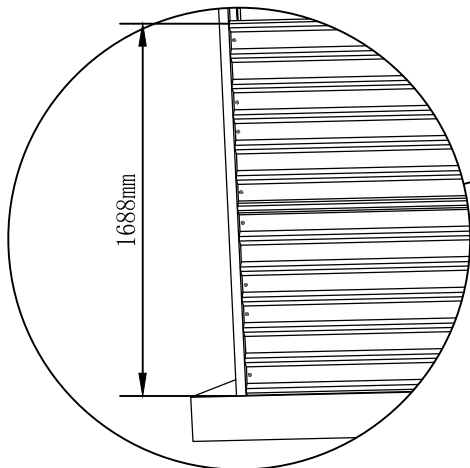
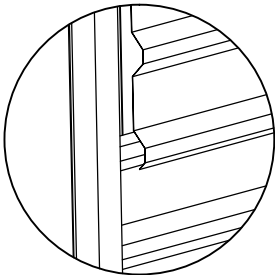

When two panels overlap, make sure upper panel covers the lower panel.

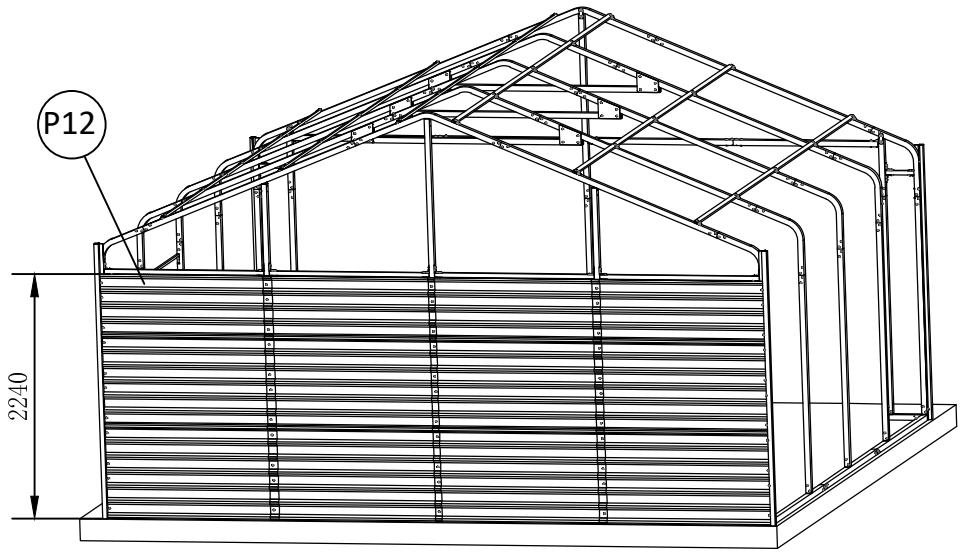
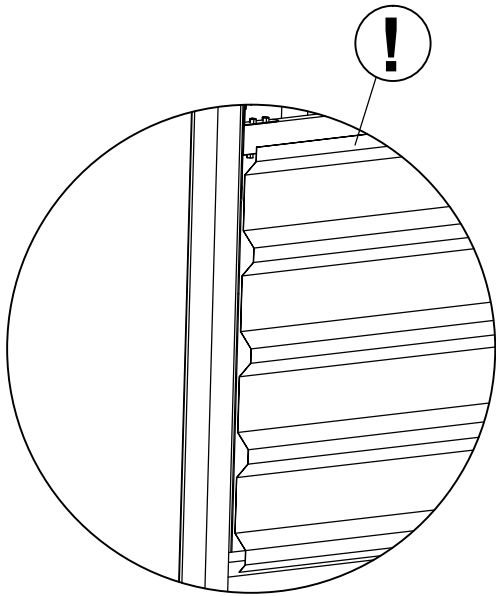

Panel Assembly - Back Wall

	P12	4		S12	20
---	-----	---	---	-----	----



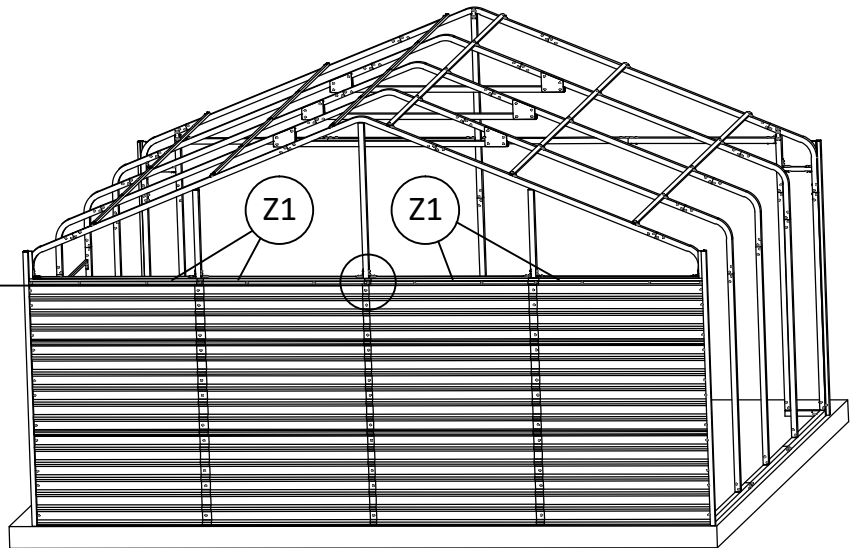
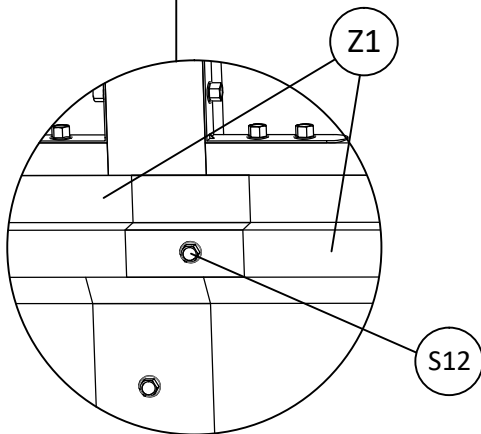
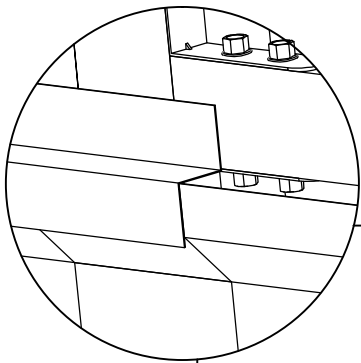

	Z1	4		S12	13
---	----	---	---	-----	----



Panel Assembly - Left Wall

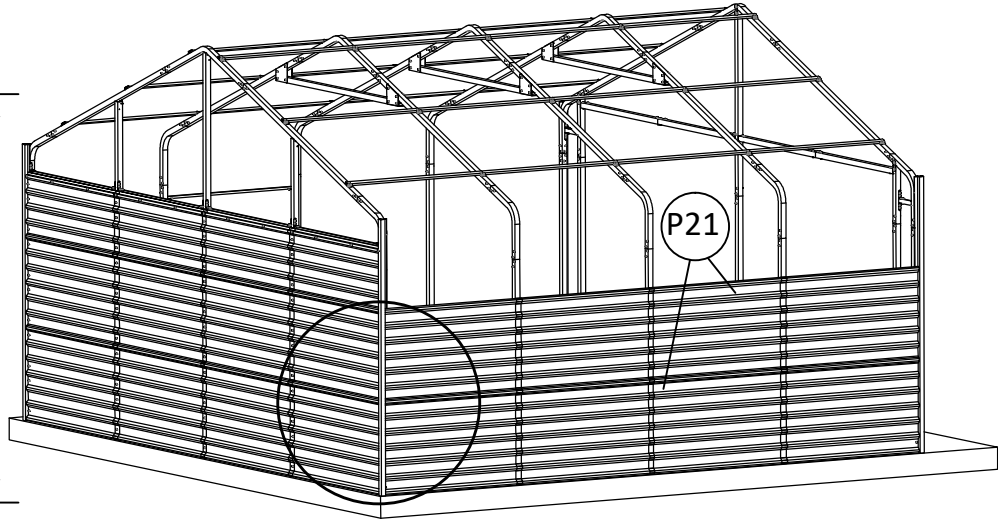
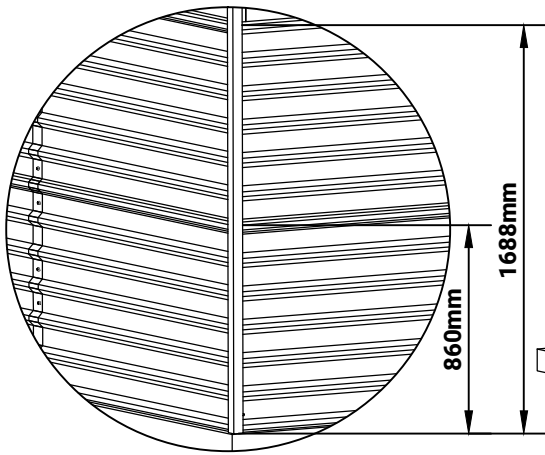

	P21	8		S12	40
---	-----	---	---	-----	----



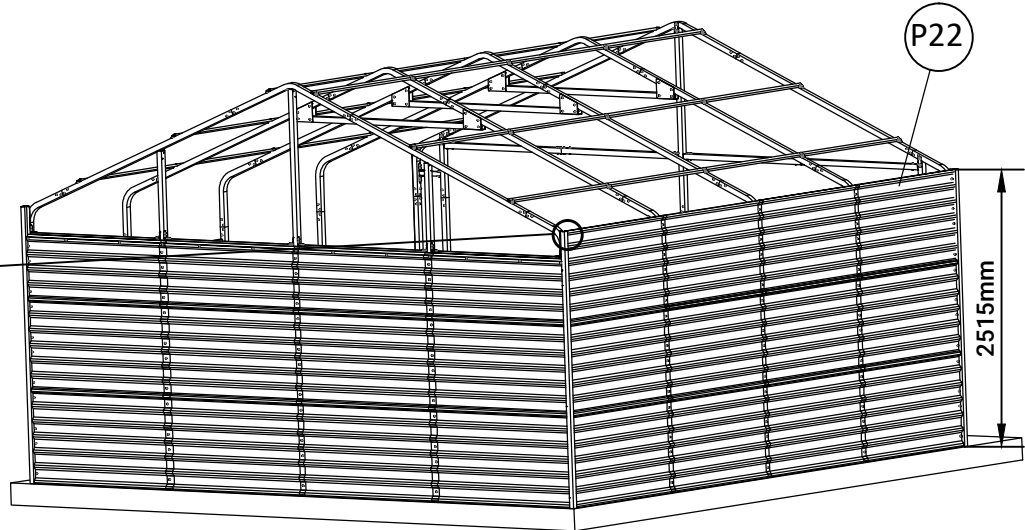
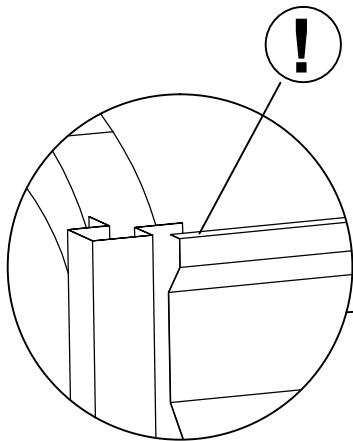



	P22	4		S12	20
---	-----	---	---	-----	----

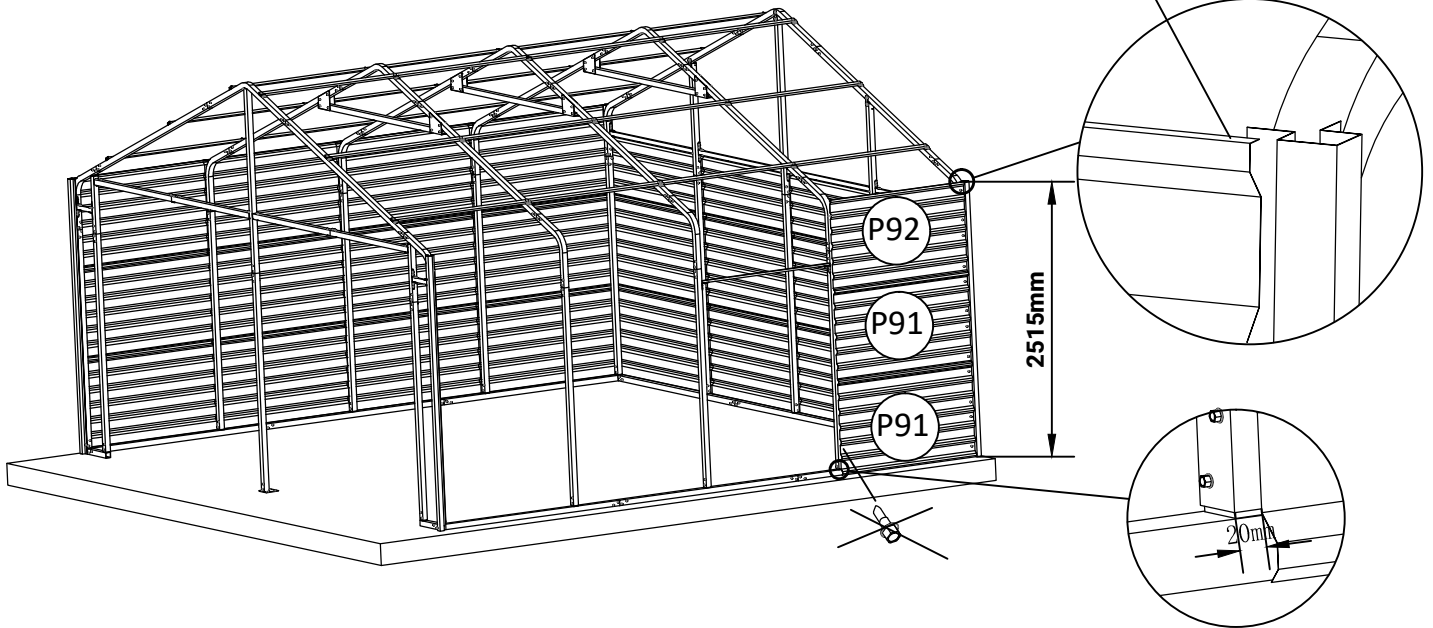

Panel Assembly - Right Wall





	P91	2		P92	1		S12	12
---	-----	---	---	-----	---	---	-----	----

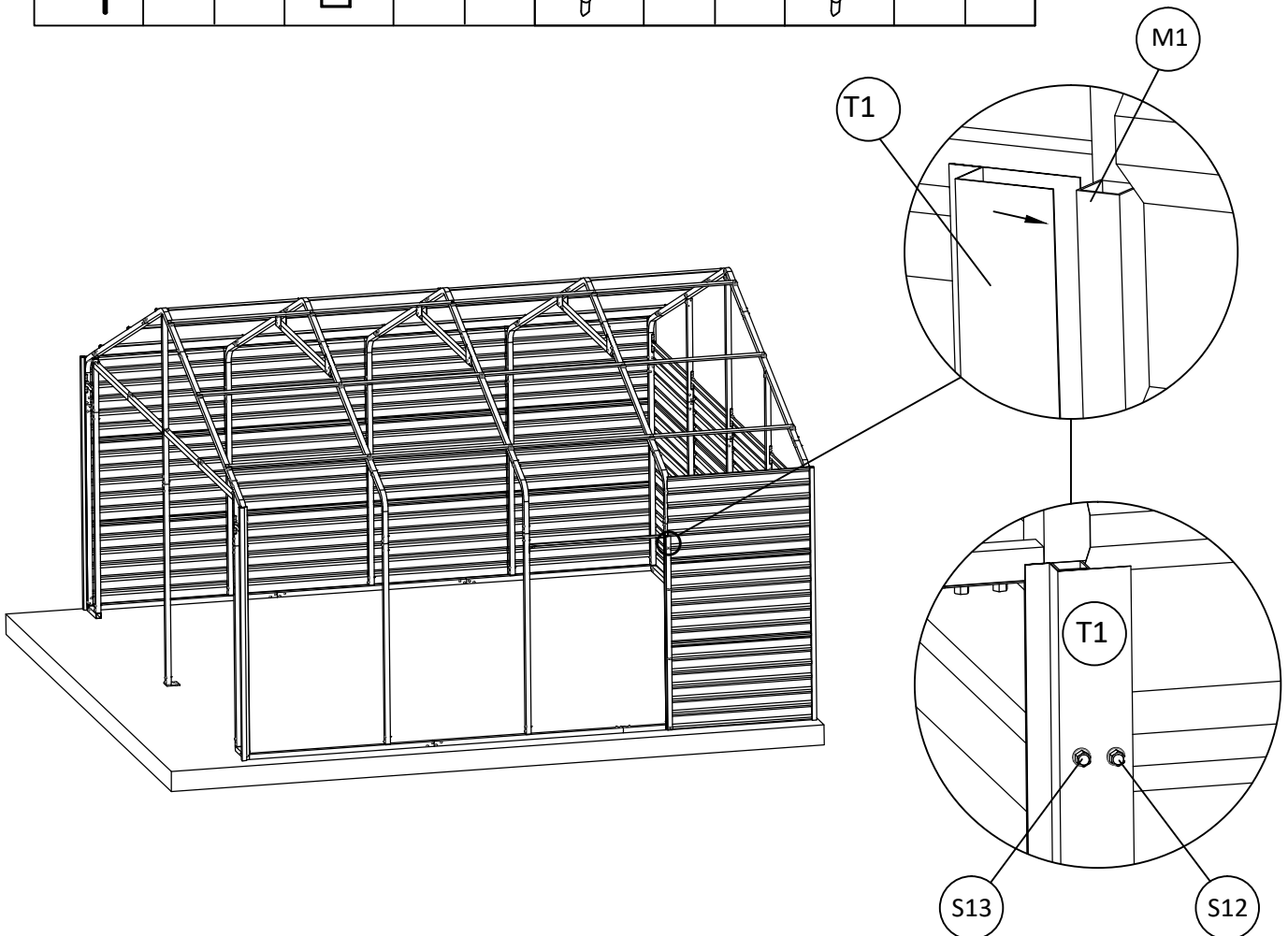





	T1	1		M1	1		S13	5		S12	5
---	----	---	---	----	---	---	-----	---	---	-----	---

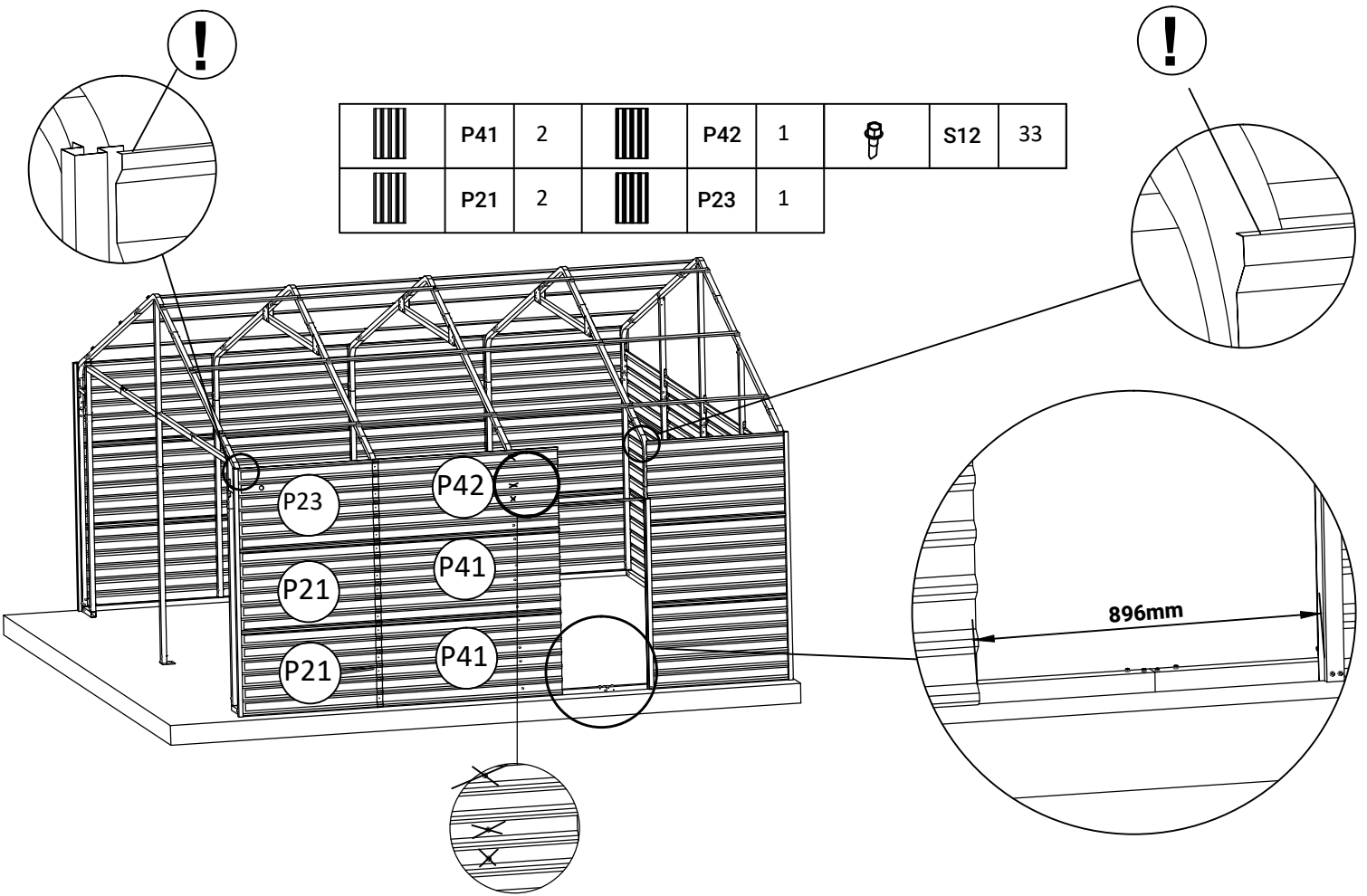

Panel Assembly - Right Wall





	P41	2		P42	1		S12	33
	P21	2		P23	1			

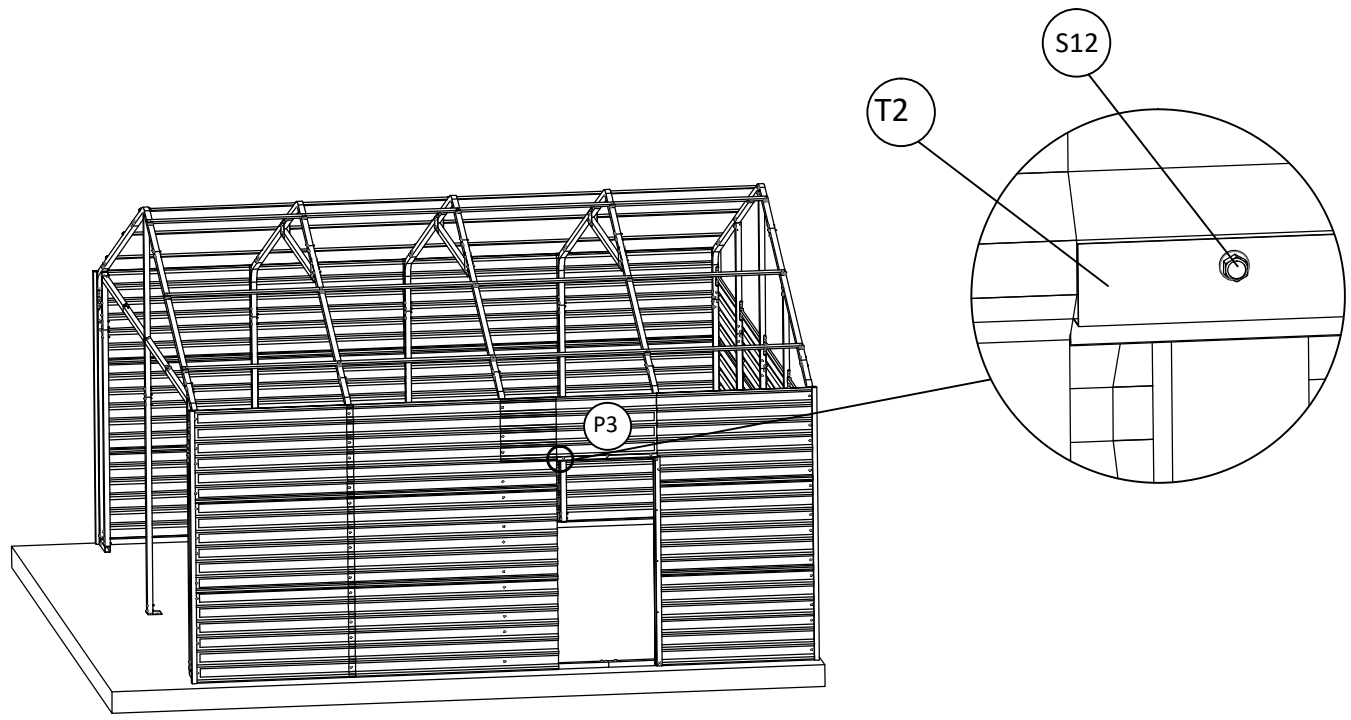

	P3	1		S12	9		T2	1
---	----	---	---	-----	---	---	----	---





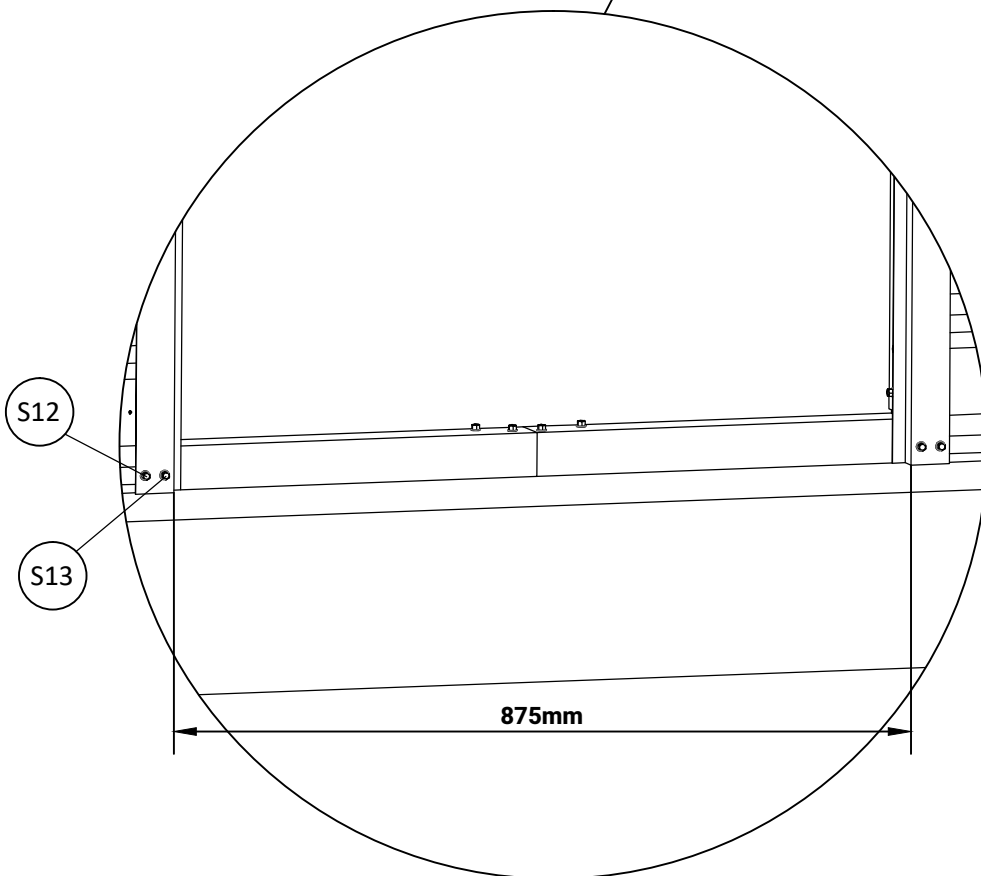
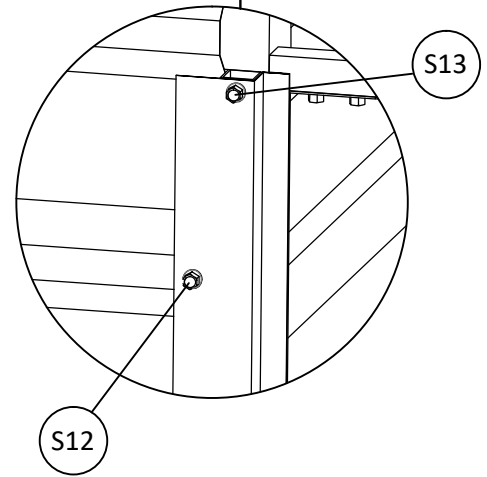
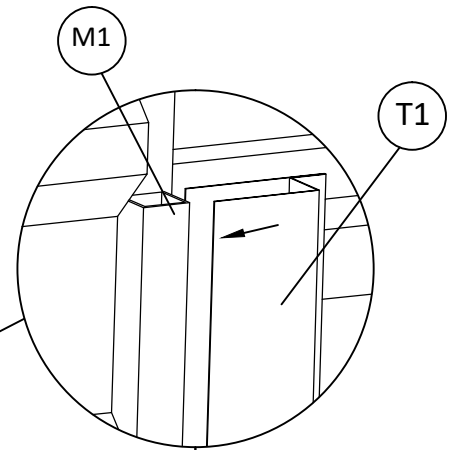
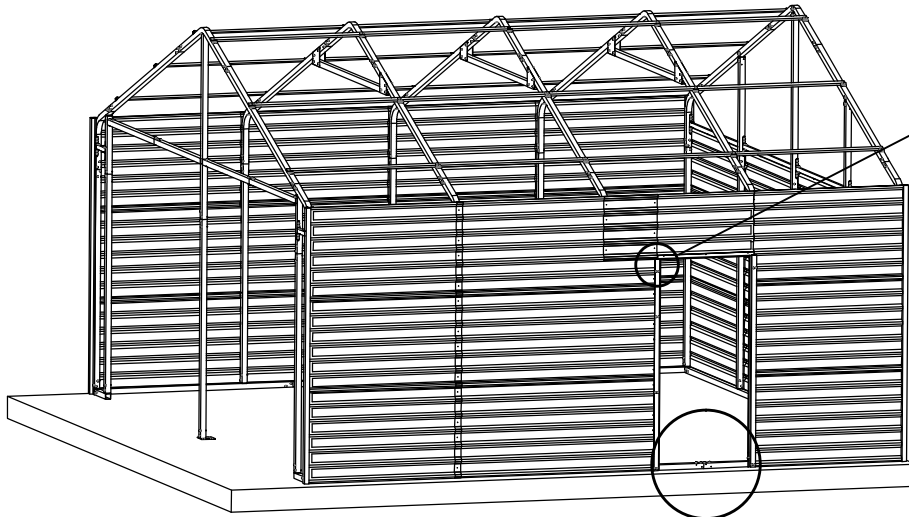

Panel Assembly - Right Wall







	T1	1		S12	8		S13	2
	M1	1						

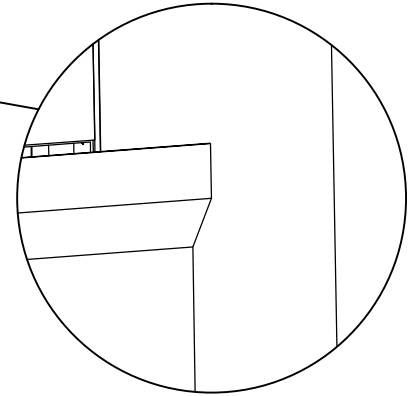
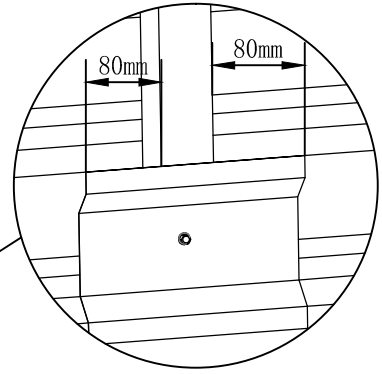
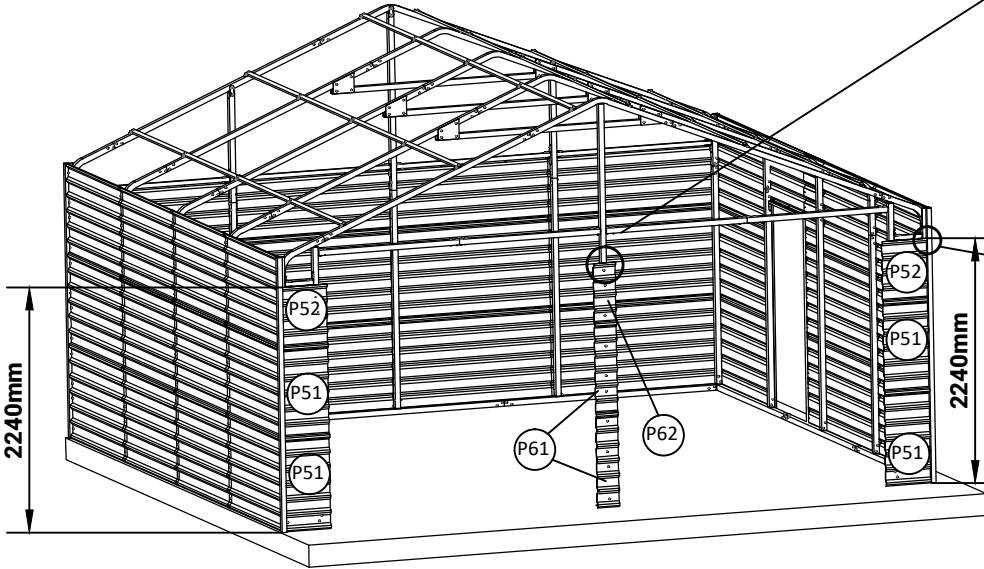

Panel Assembly - Front Wall



	P51	4		P52	2		S12	51
	P61	2		P62	1			

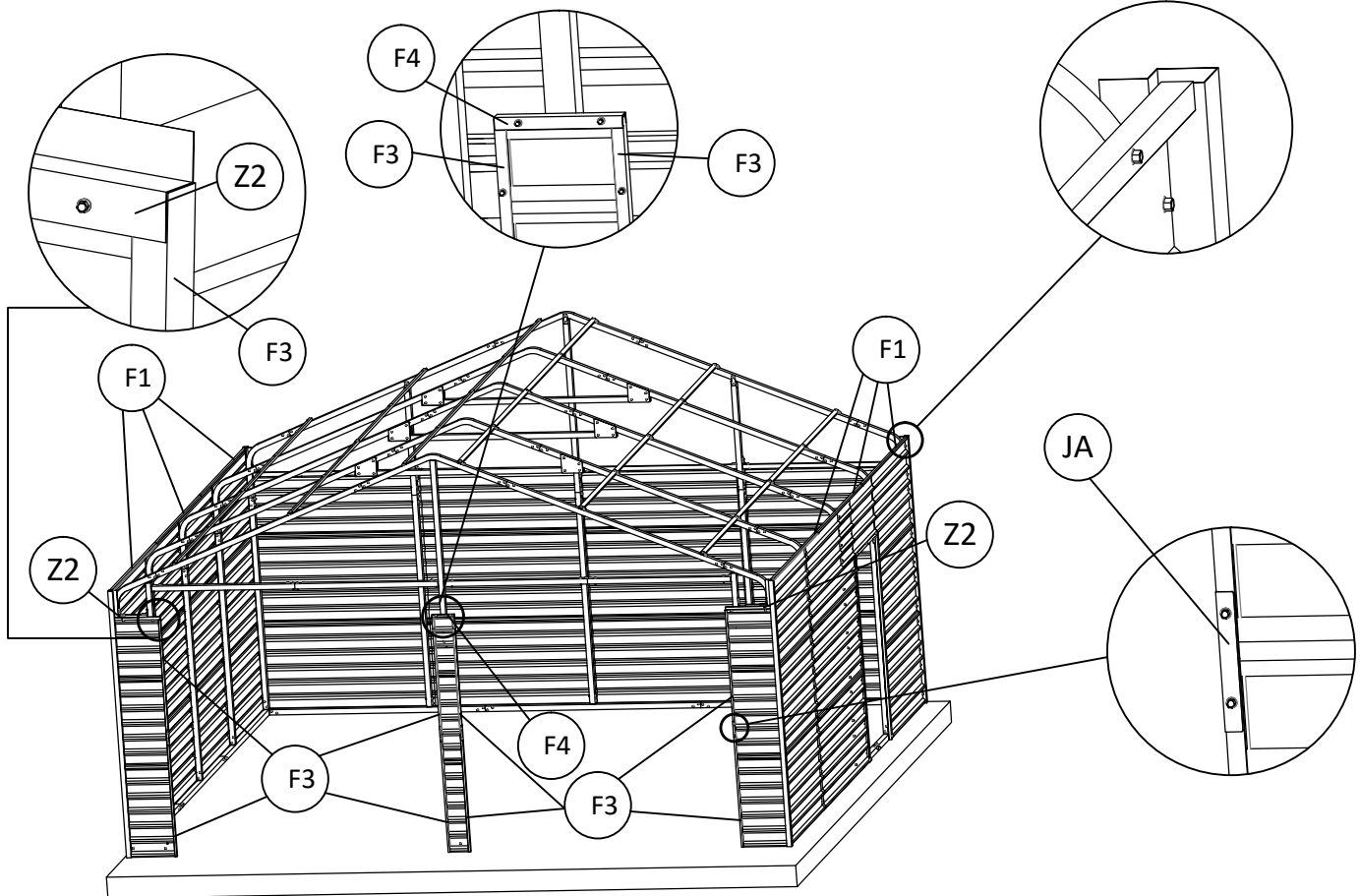

	F1	6		F3	8		F4	1		Z2	2		S12	86
	JA	8												







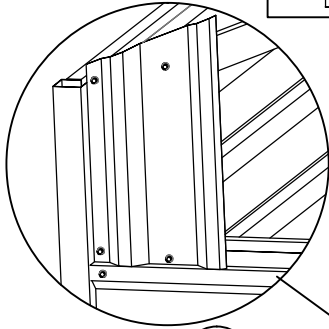



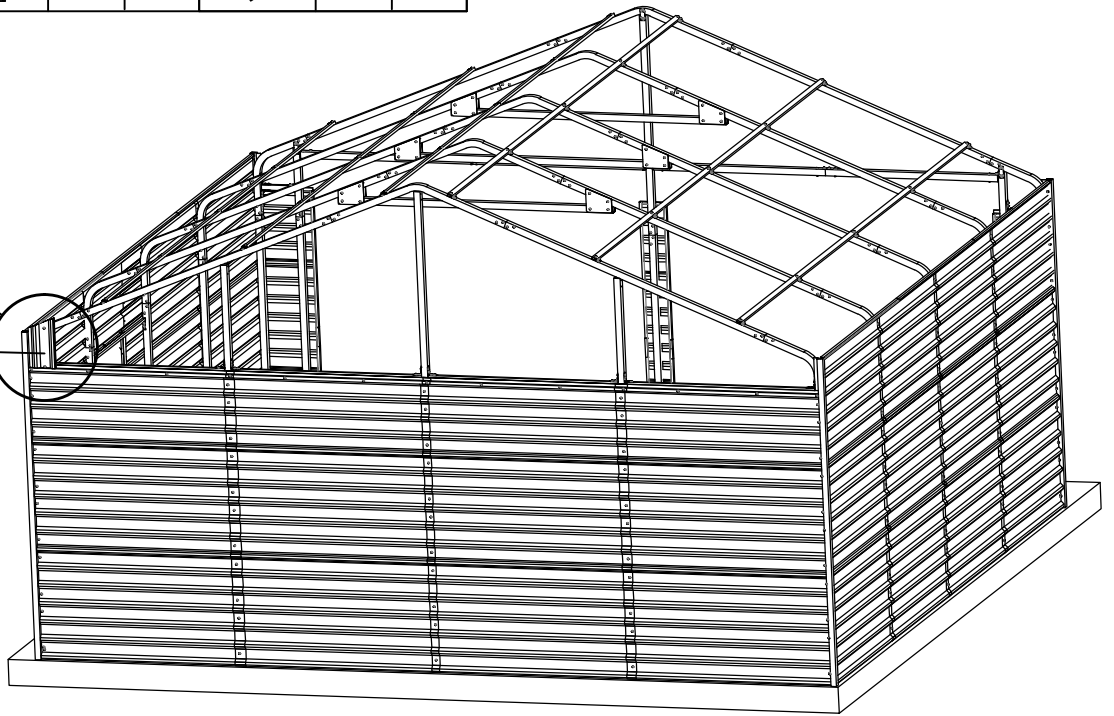

Panel Assembly

	PA1	1		S12	4
---	-----	---	---	-----	---









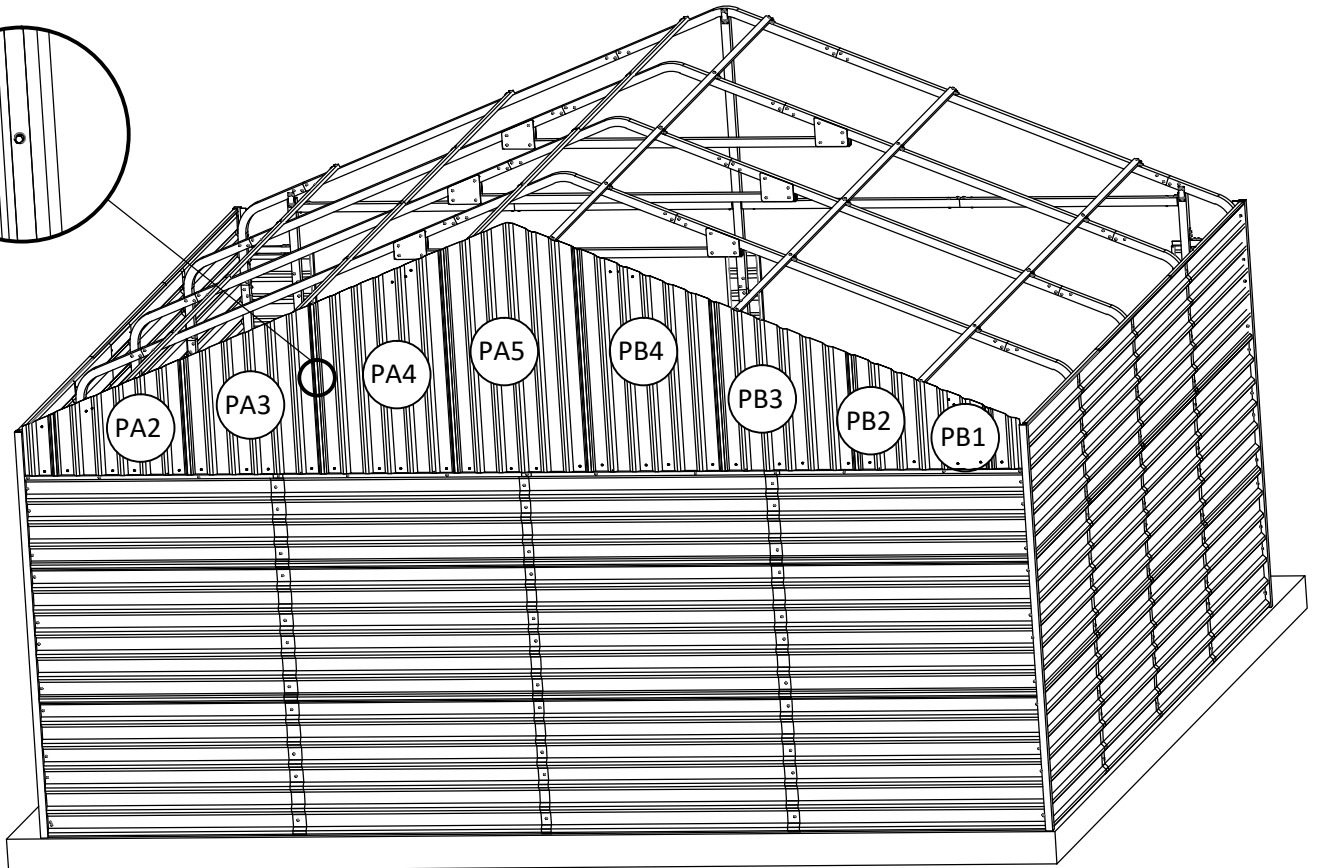
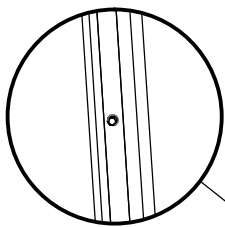



PA1







	PA2	1		PA3	1		PA4	1		PA5	1		PB4	1
	PB3	1		PB2	1		PB1	1		S12	72			

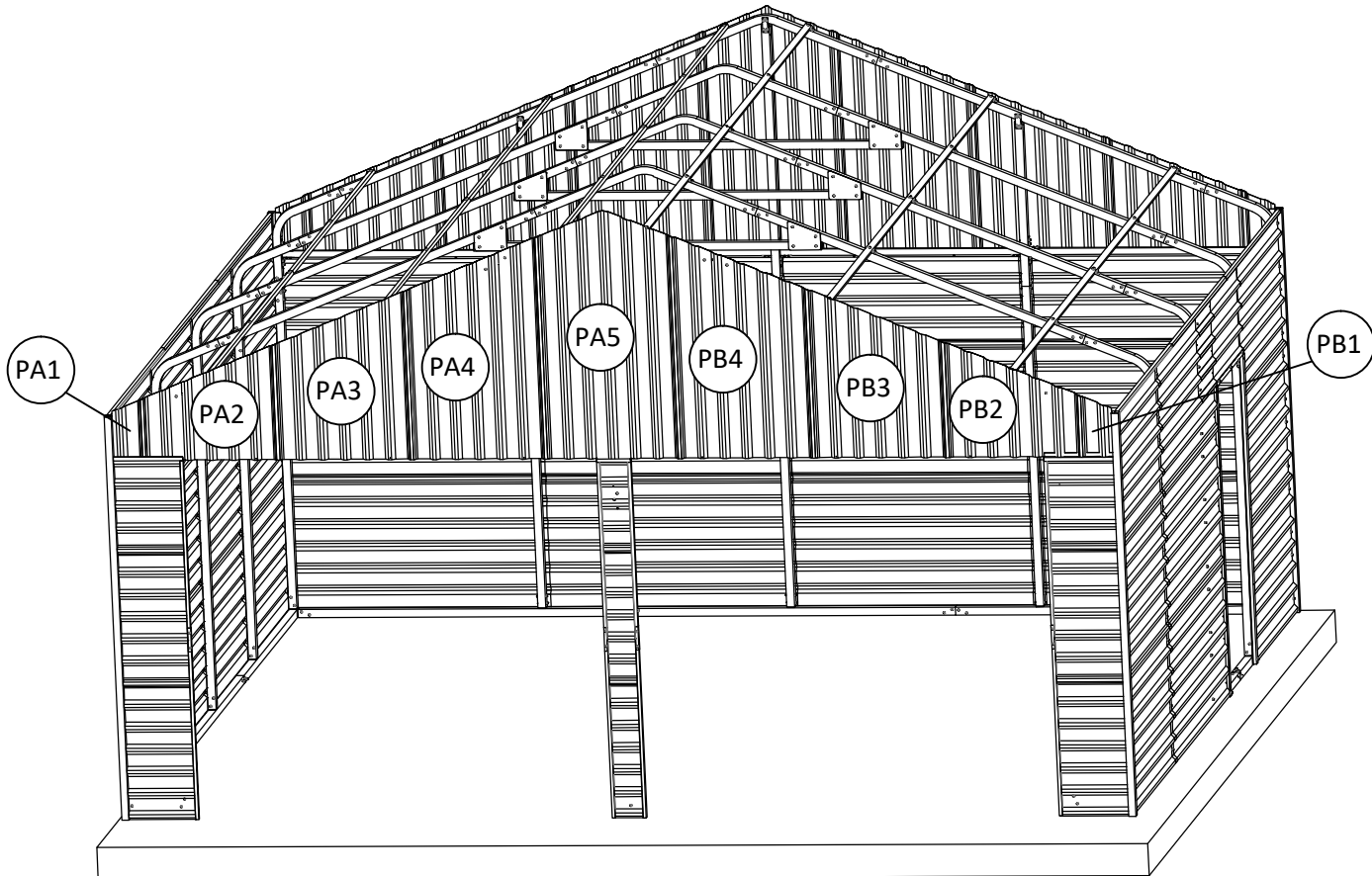

FRAME ASSEMBLY-Front Wall



	PA2	1		PA3	1		PA4	1		PA5	1		PB4	1
	PB3	1		PB2	1		PB1	1		PA1	1		S12	72

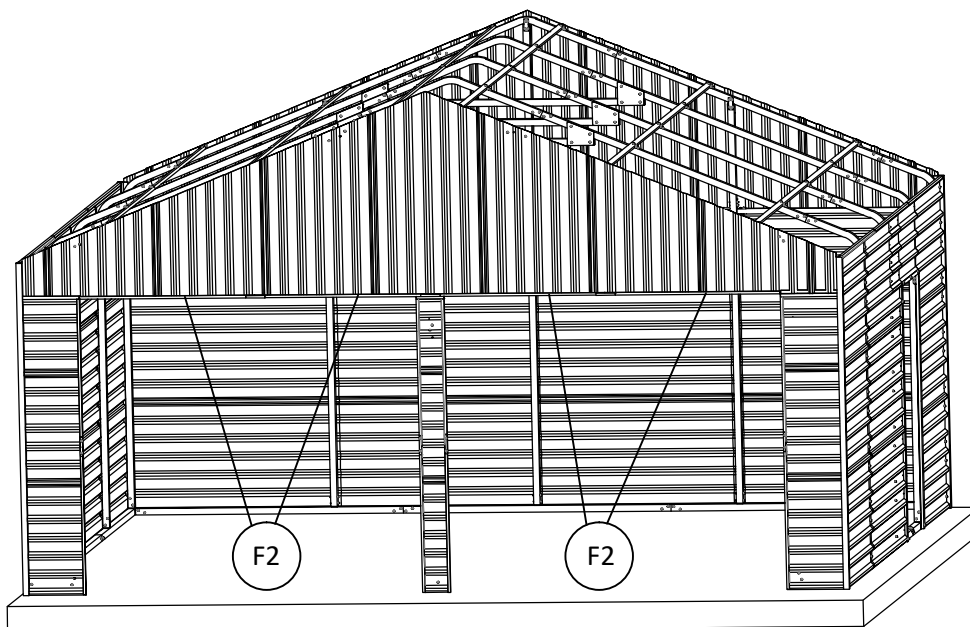

	F2	4		JA	3		S12	28
---	----	---	---	----	---	---	-----	----



FRAME ASSEMBLY-Roof

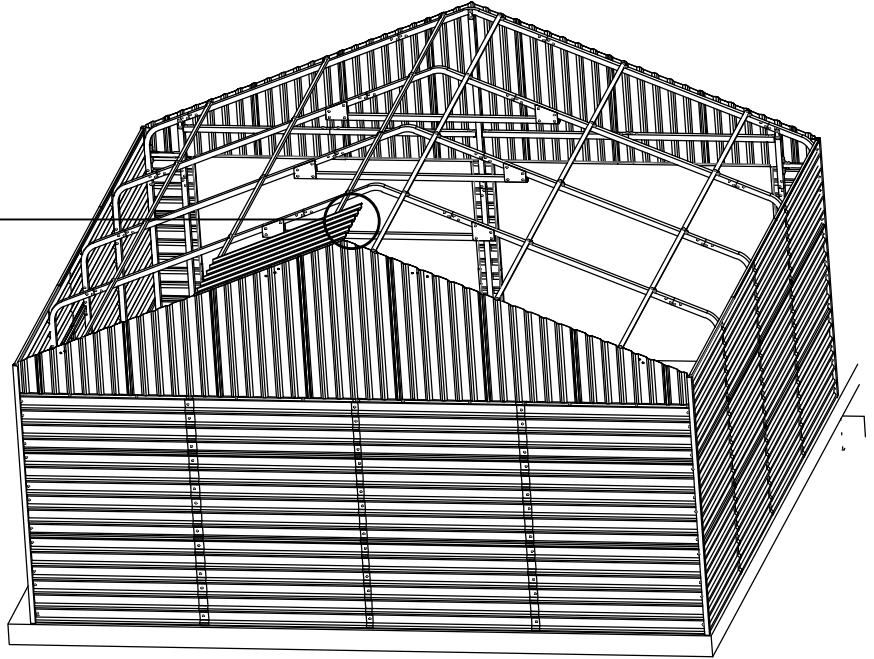
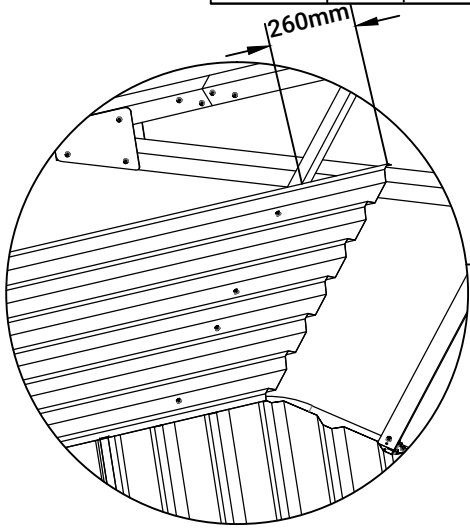

	P8	1		S12	4
---	----	---	---	-----	---

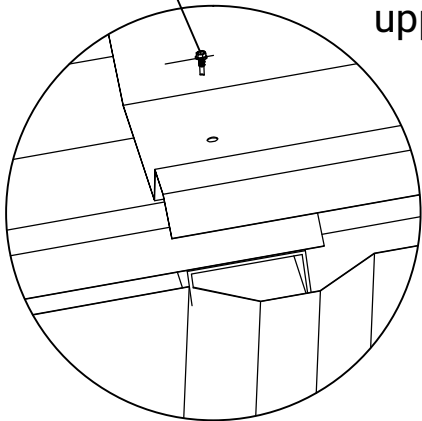

S12





When two panels overlap, make sure upper panel covers the lower panel.

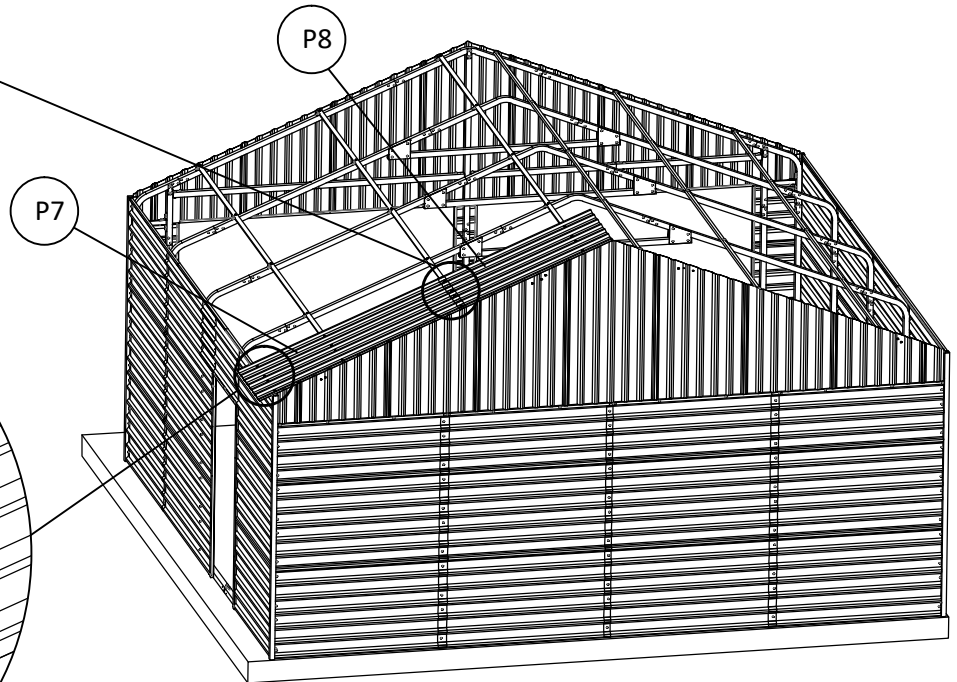
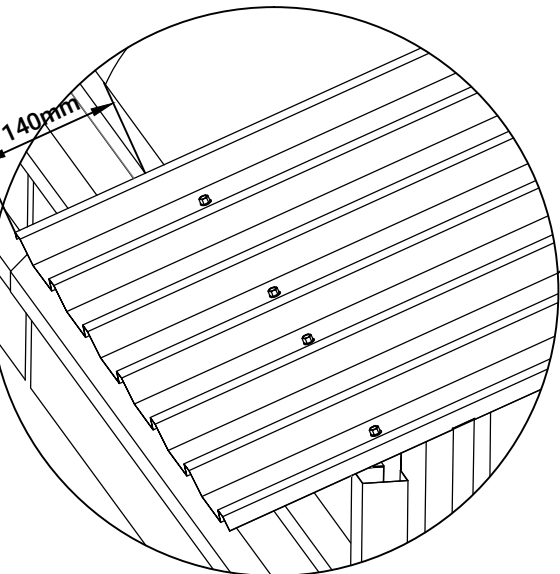

	P7	1		S12	12
---	----	---	---	-----	----



FRAME ASSEMBLY-Roof

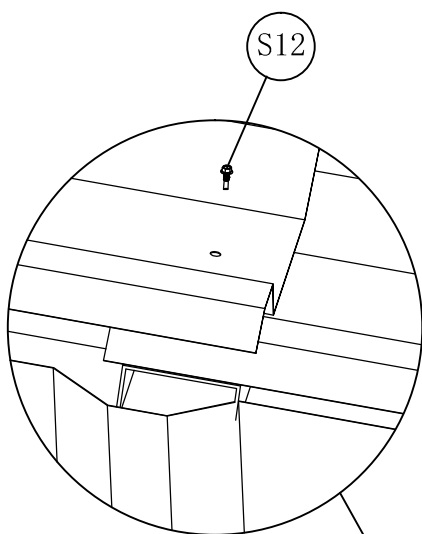
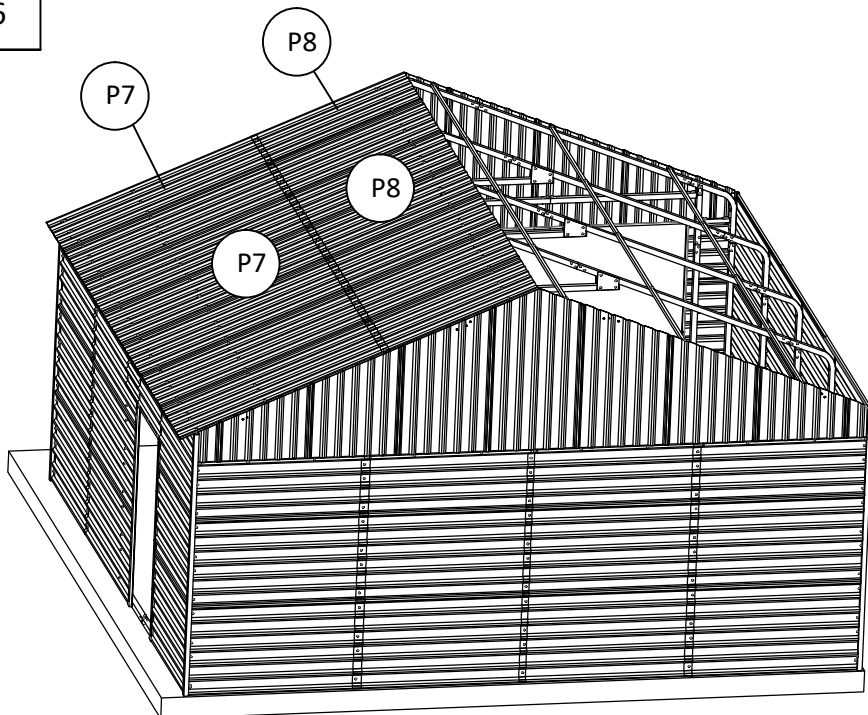



	P7	6		P8	6
	S12	80			

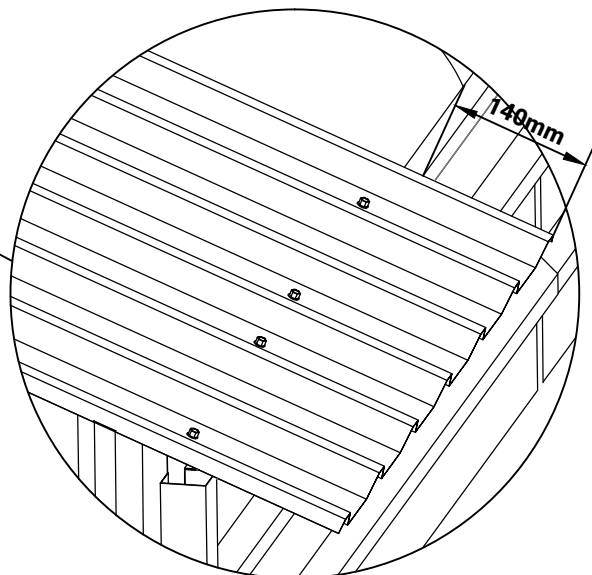
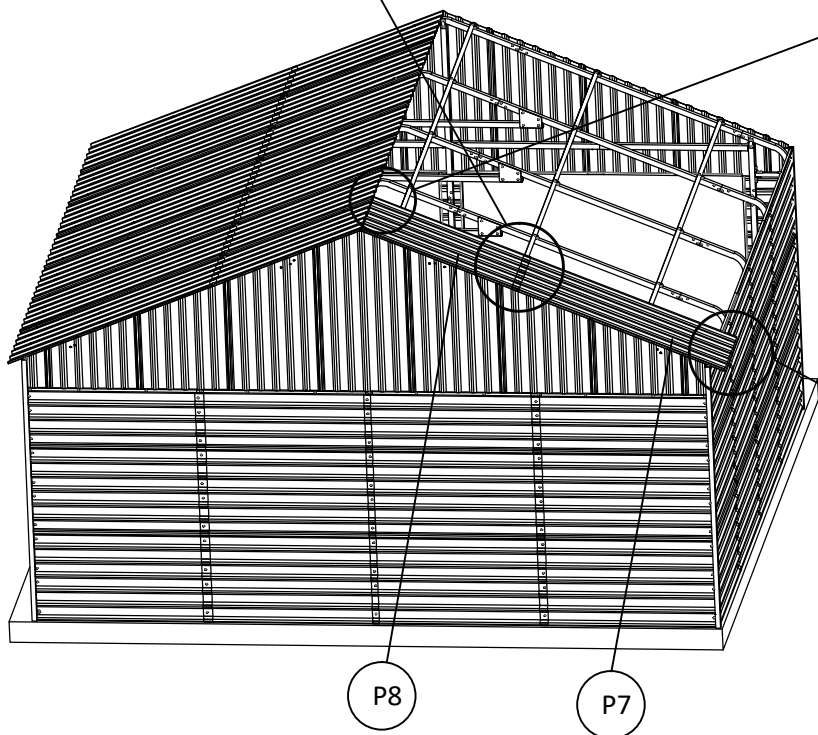
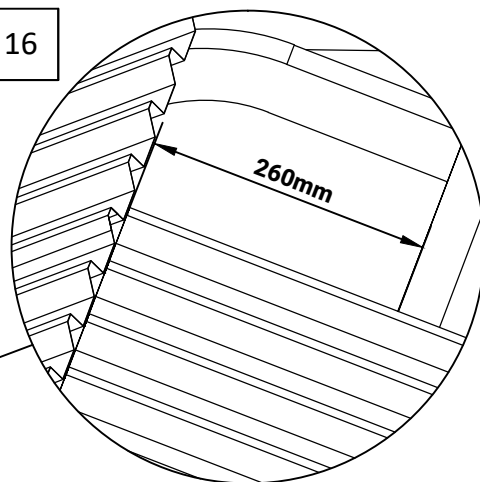







	P7	1		S12	16
	P8	1			

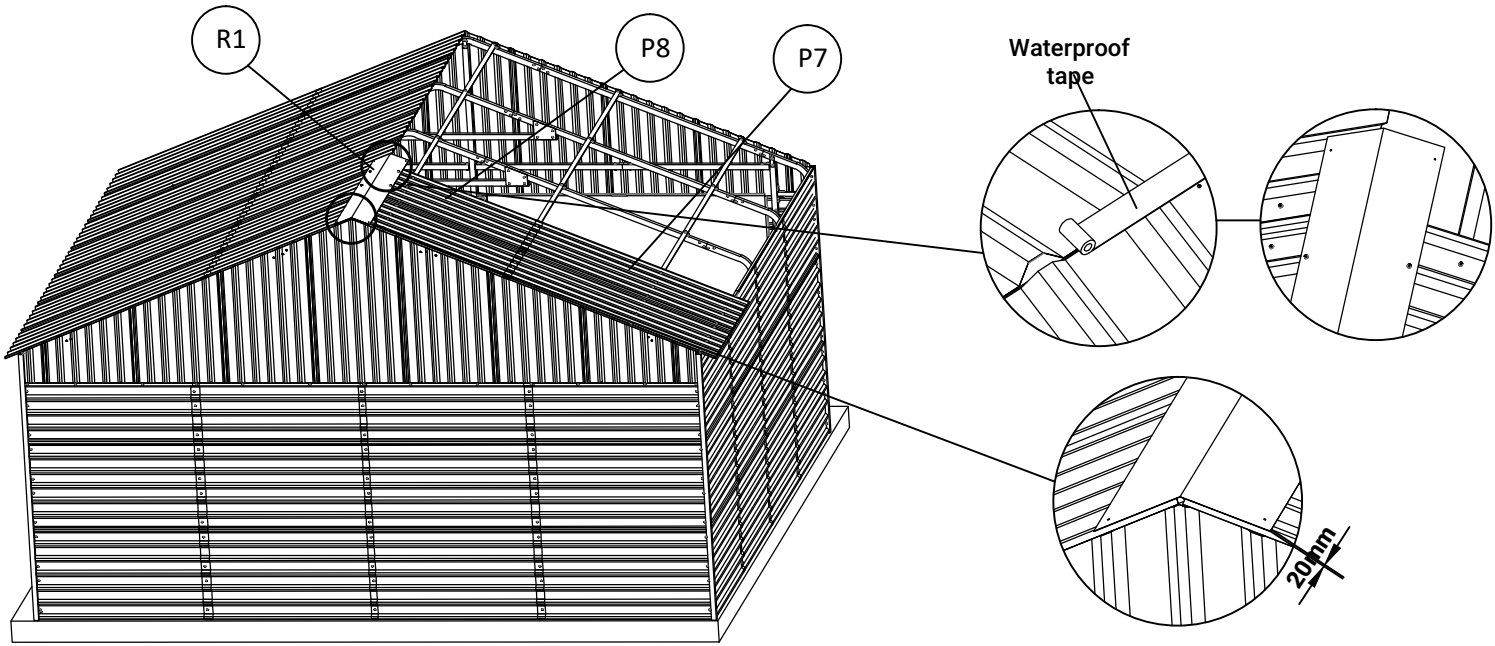

FRAME ASSEMBLY-Roof

	P7	1		P8	1		R1	1		S12	20		Waterproof tape
---	----	---	---	----	---	---	----	---	--	-----	----	---	-----------------





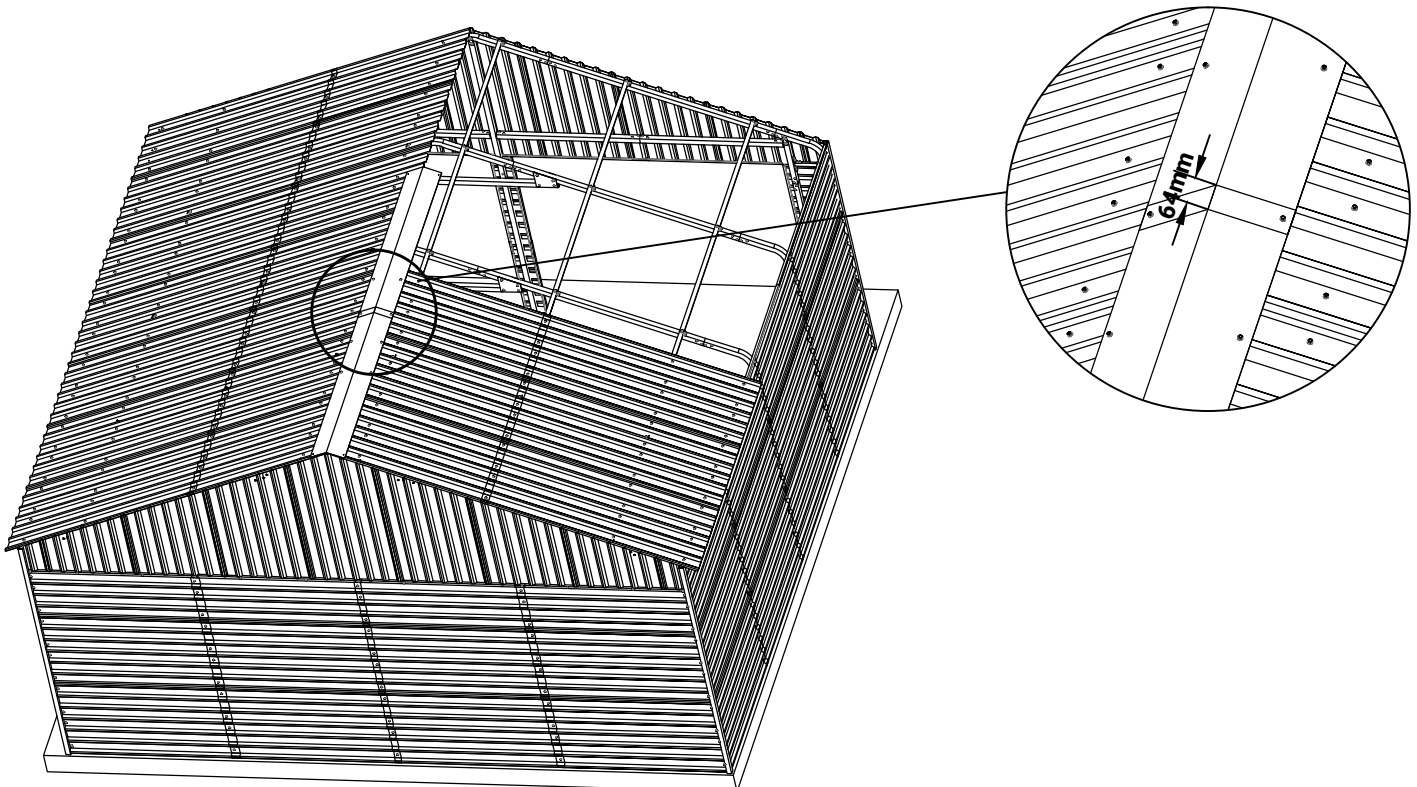

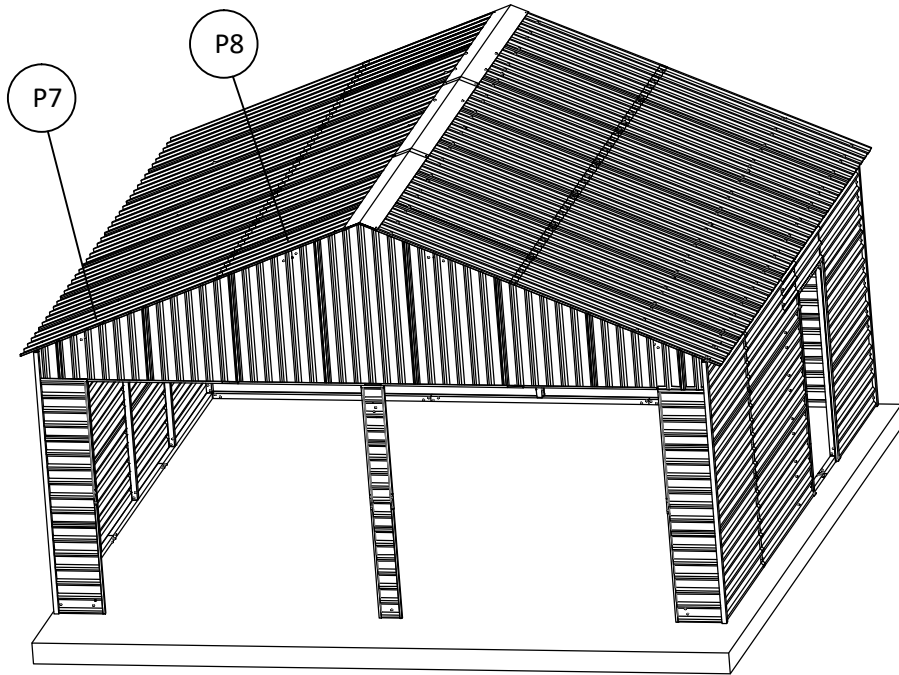

	P7	1		P8	1		R1	1		S12	20		Waterproof tape
--	----	---	--	----	---	--	----	---	--	-----	----	--	-----------------



FRAME ASSEMBLY-Roof



	P7	4		P8	4
	S12	54		R1	1
	Waterproof tape				

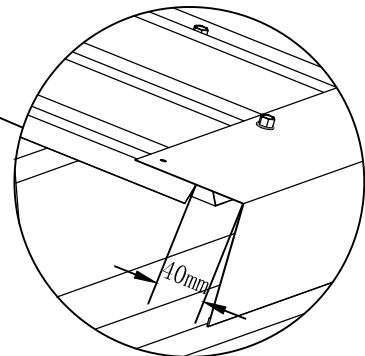
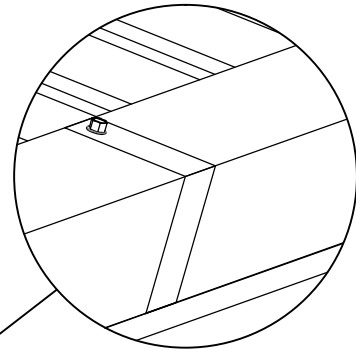
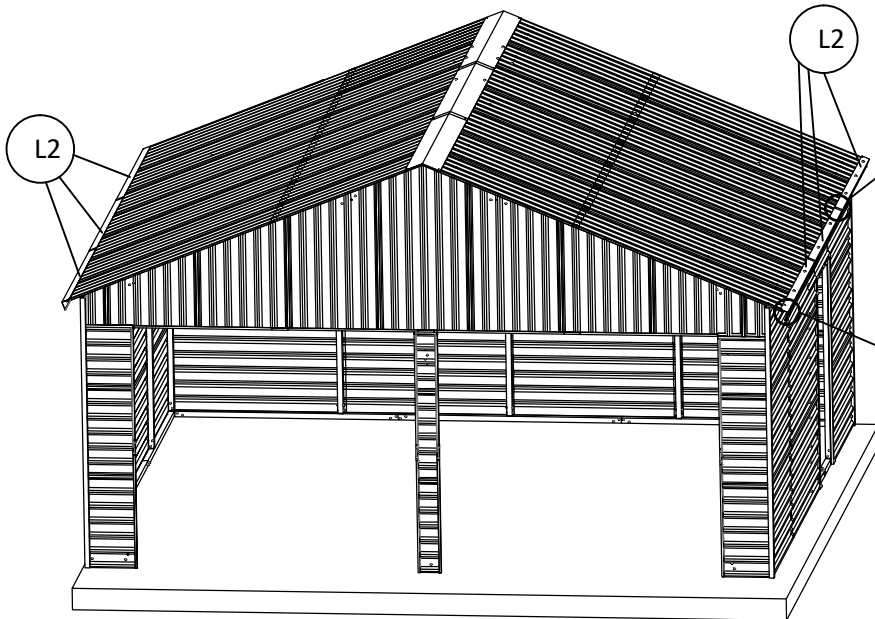

	L2	6		S12	20
---	----	---	---	-----	----



FRAME ASSEMBLY-Roof

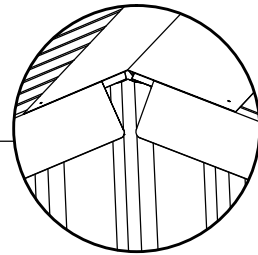
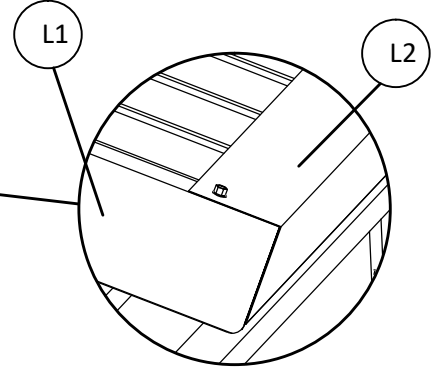
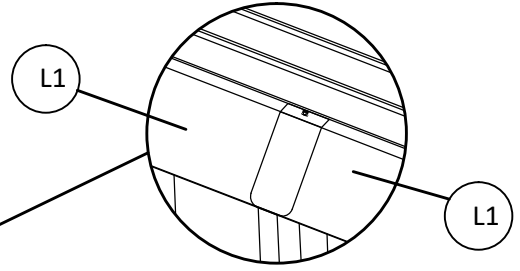
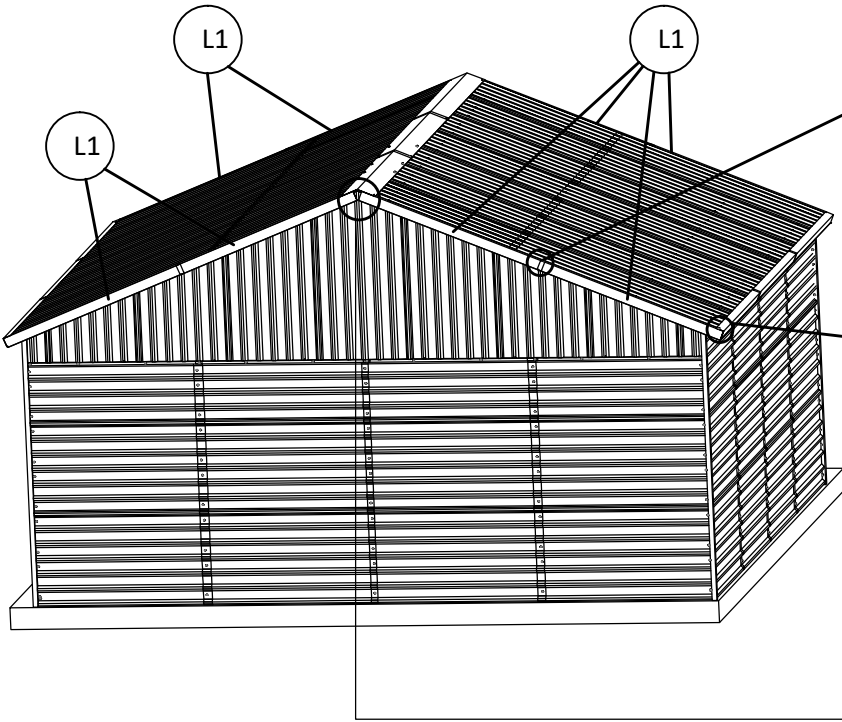



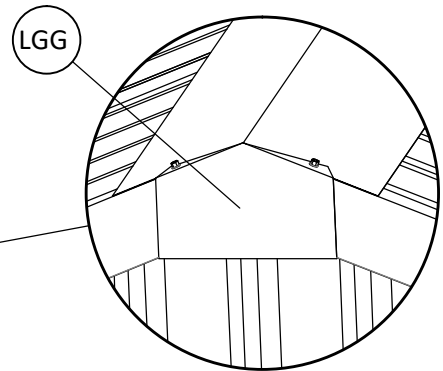
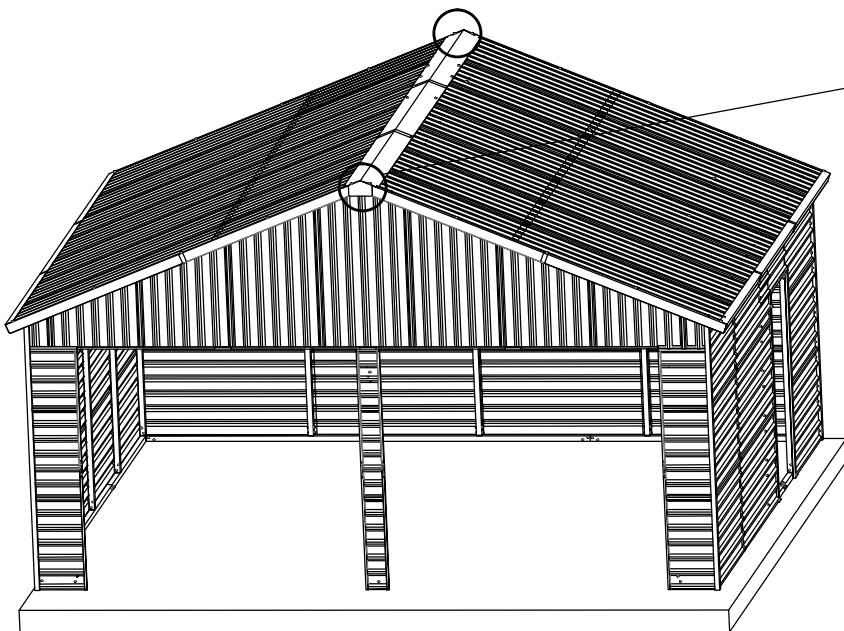

	L1	8		S12	20
---	----	---	---	-----	----



	LGG	2		S12	4
---	-----	---	---	-----	---





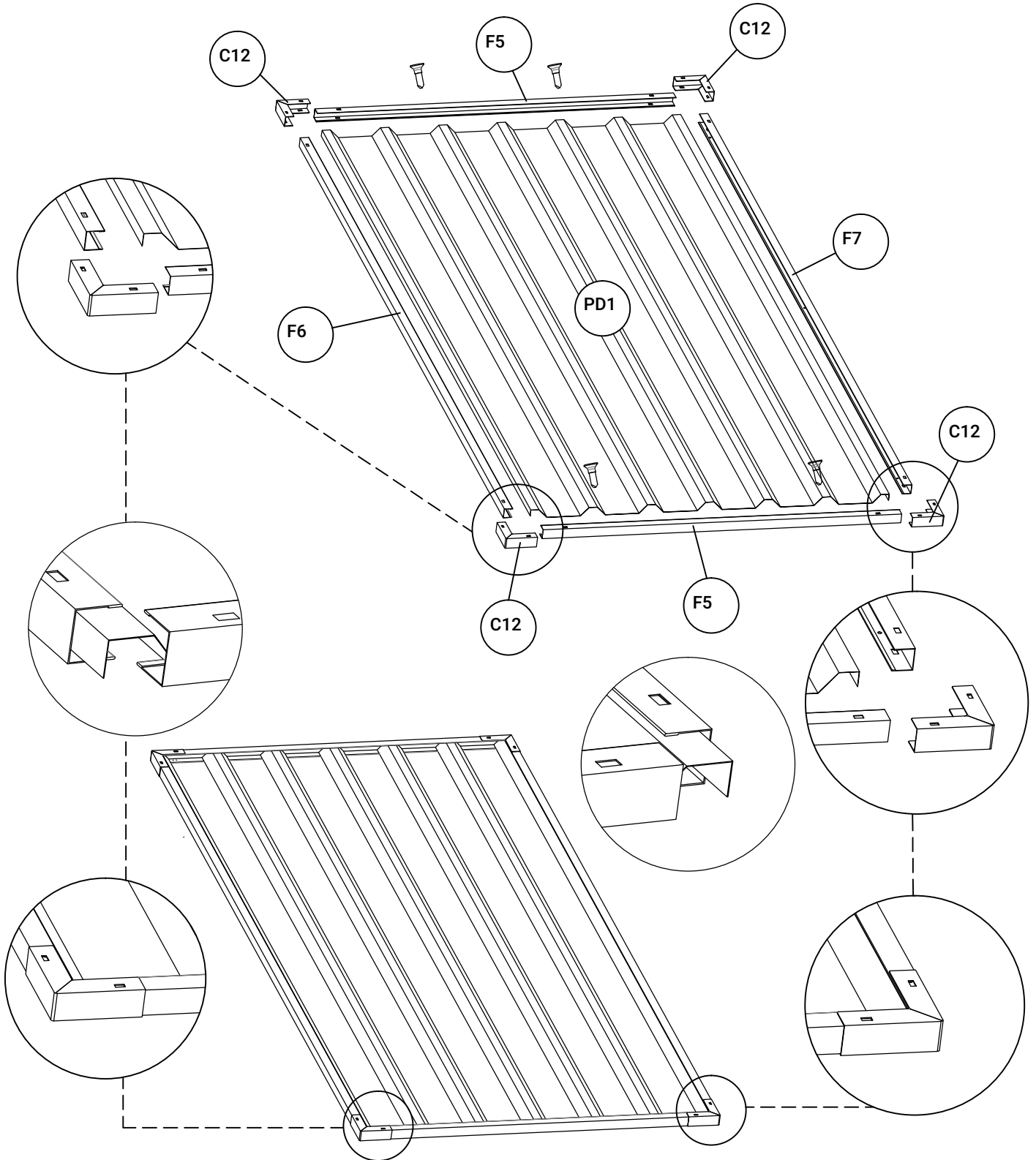

STEP 1.

	PD1	1		F5	2		F6	1
	C12	4		F7	1		S1	4





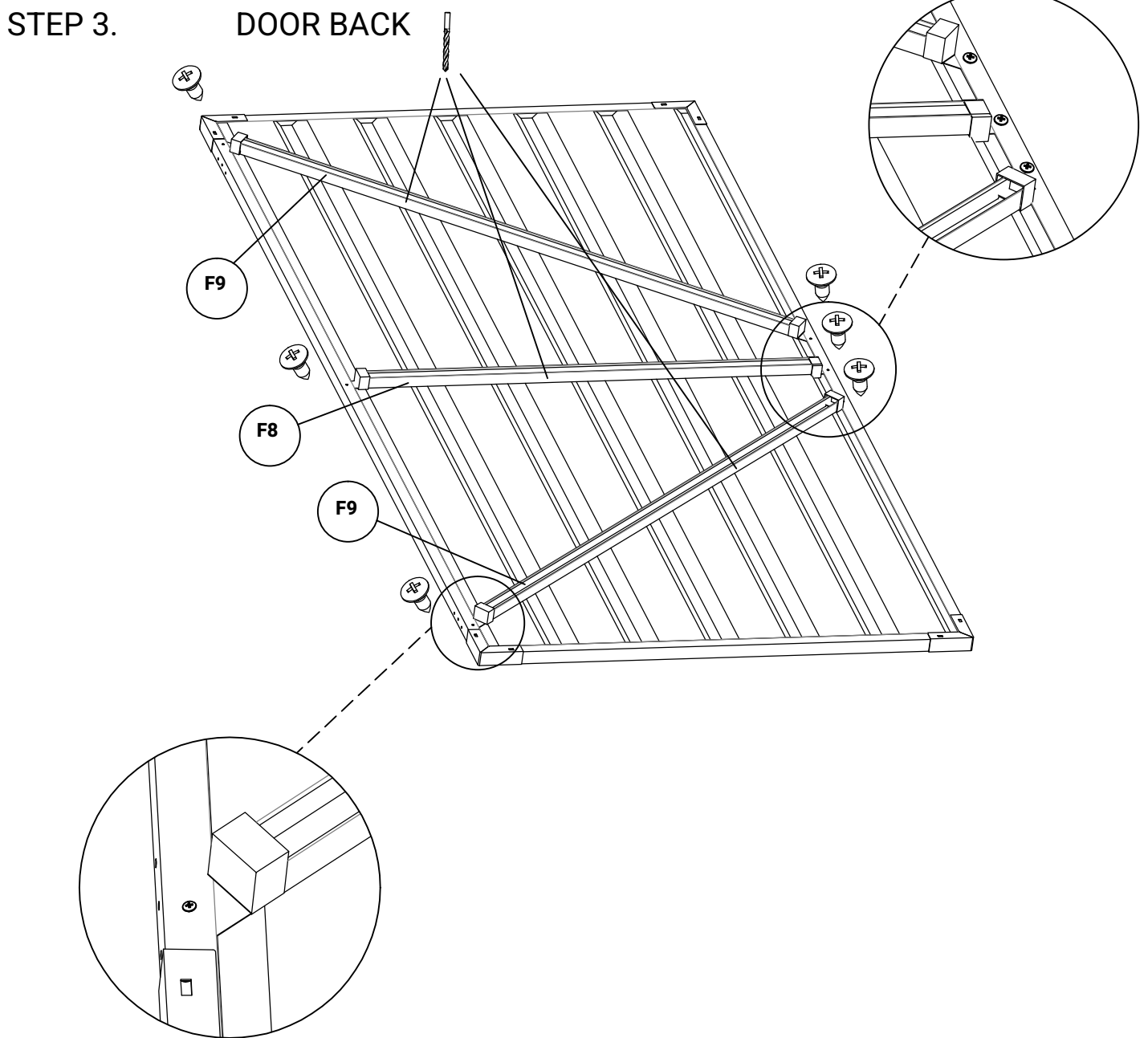
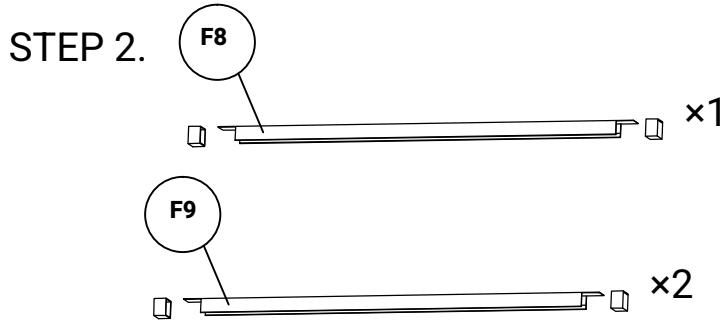

DOOR ASSEMBLY - SIDE DOOR

	F8	1		F9	2
	S1	6		L1A	6



DOOR ASSEMBLY - SIDE DOOR

STEP 4.

	SH1	2		S1	18
	S16	6		L3	18
	MSA	2			

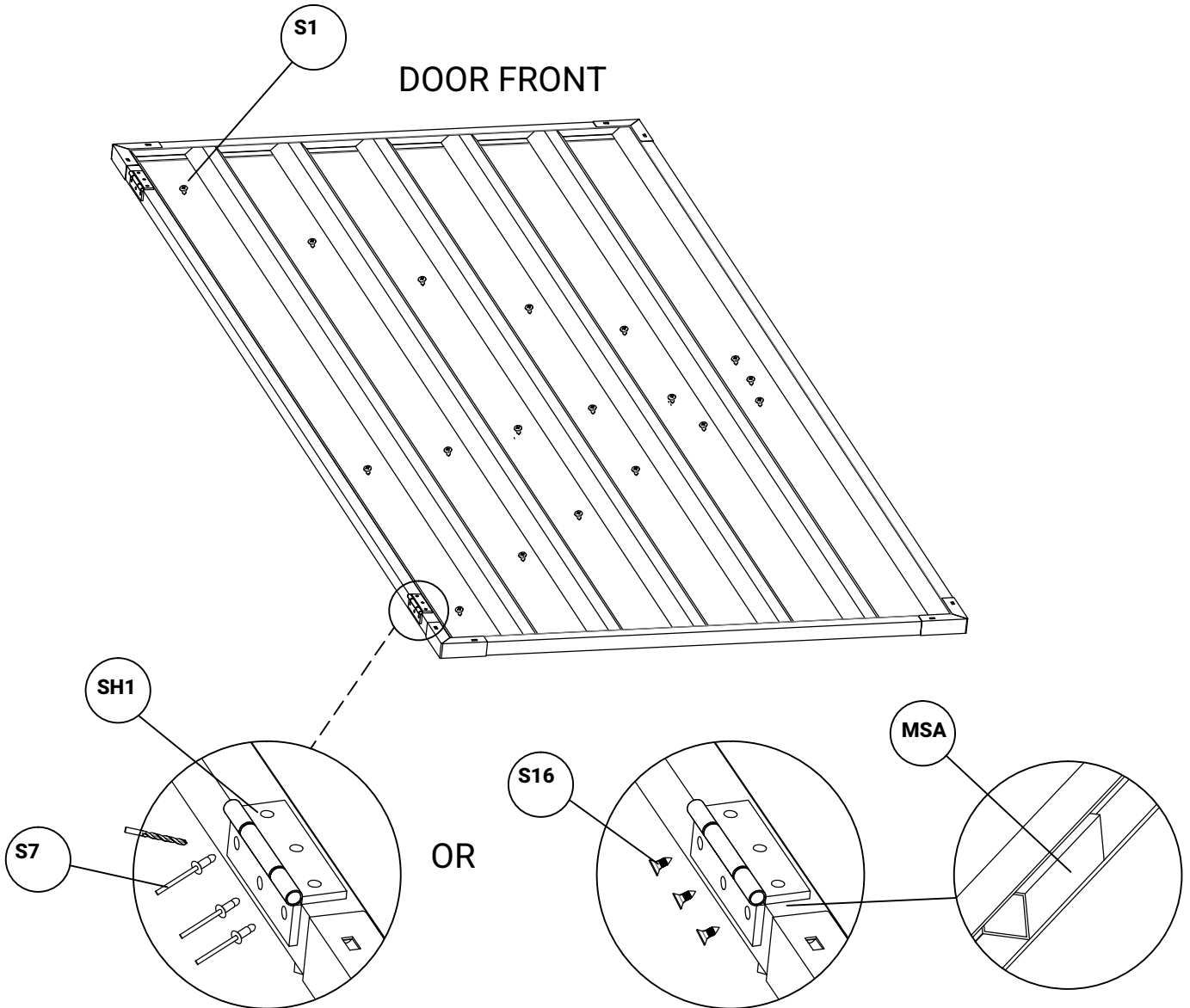

Adjust the position of the door, mark on TE1 and use the drill to drill through, then use S7 or S16 to connect.

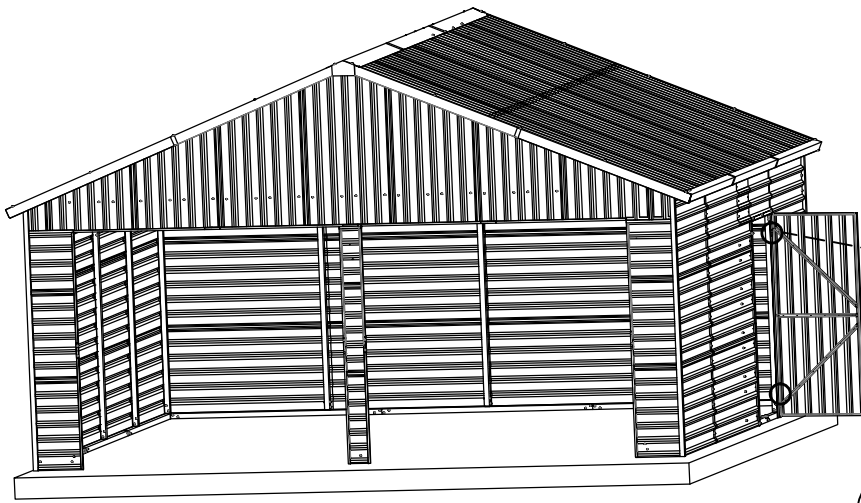

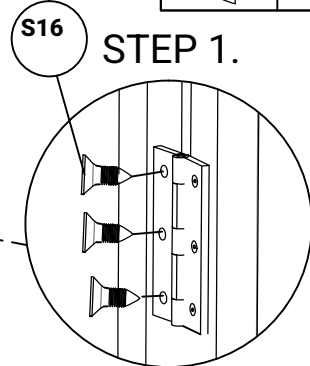

	S16	12
---	-----	----

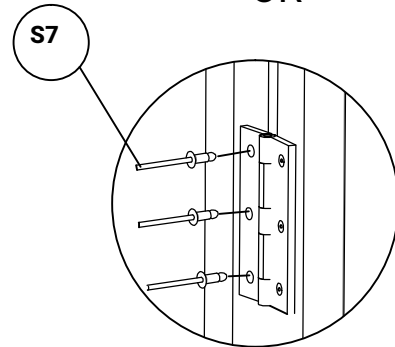

OR





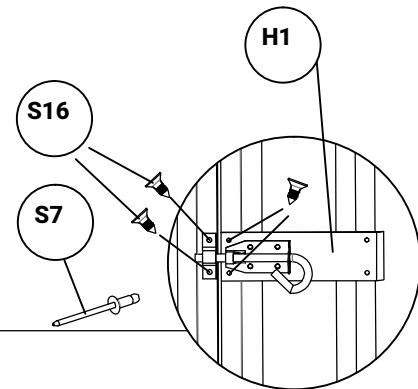
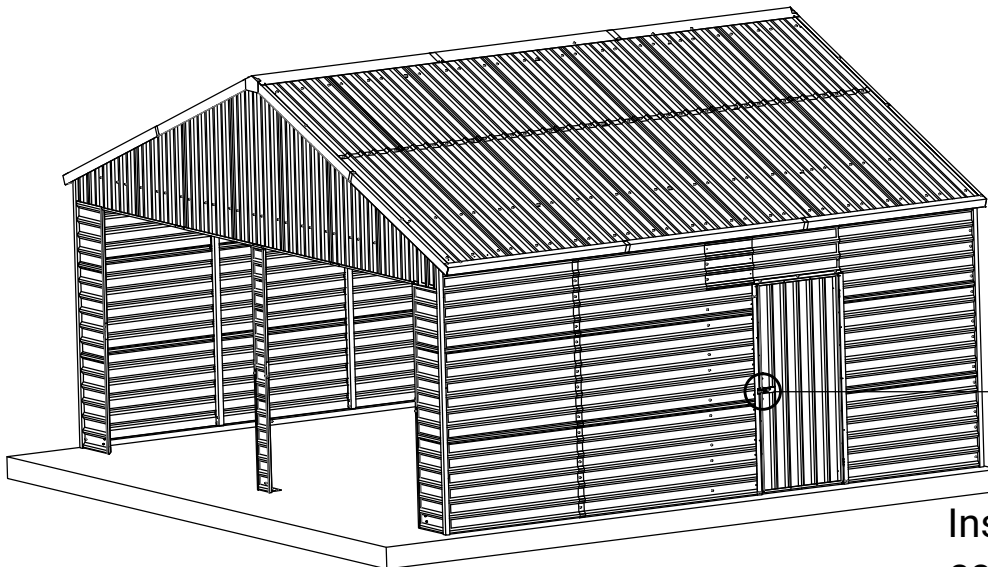

	H1	1
	S16	6





Install the latch in position as shown and fix with S16 or S7.

SHED ASSEMBLY

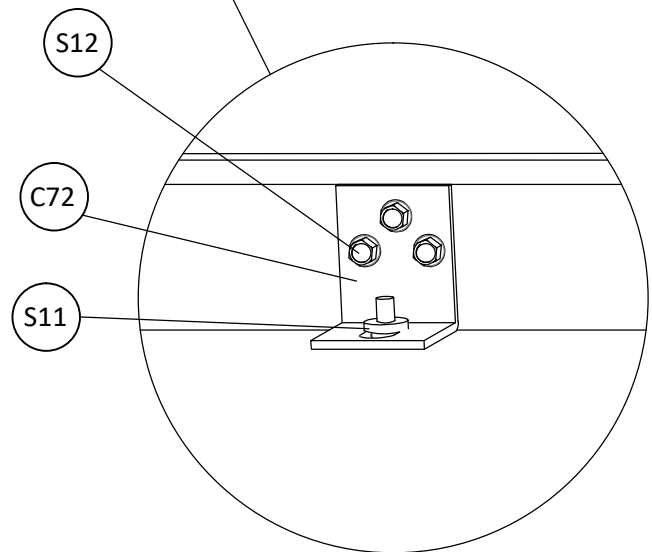
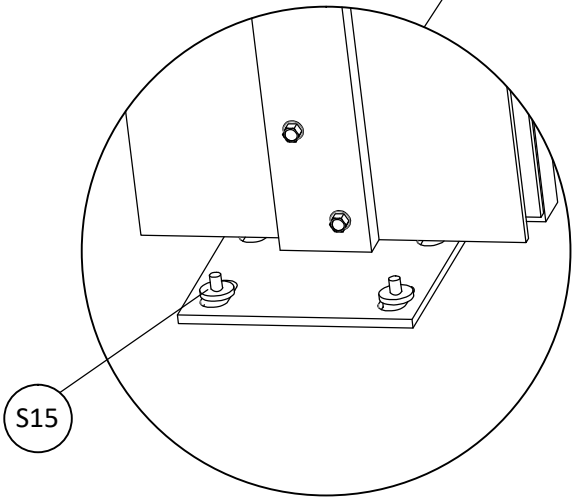
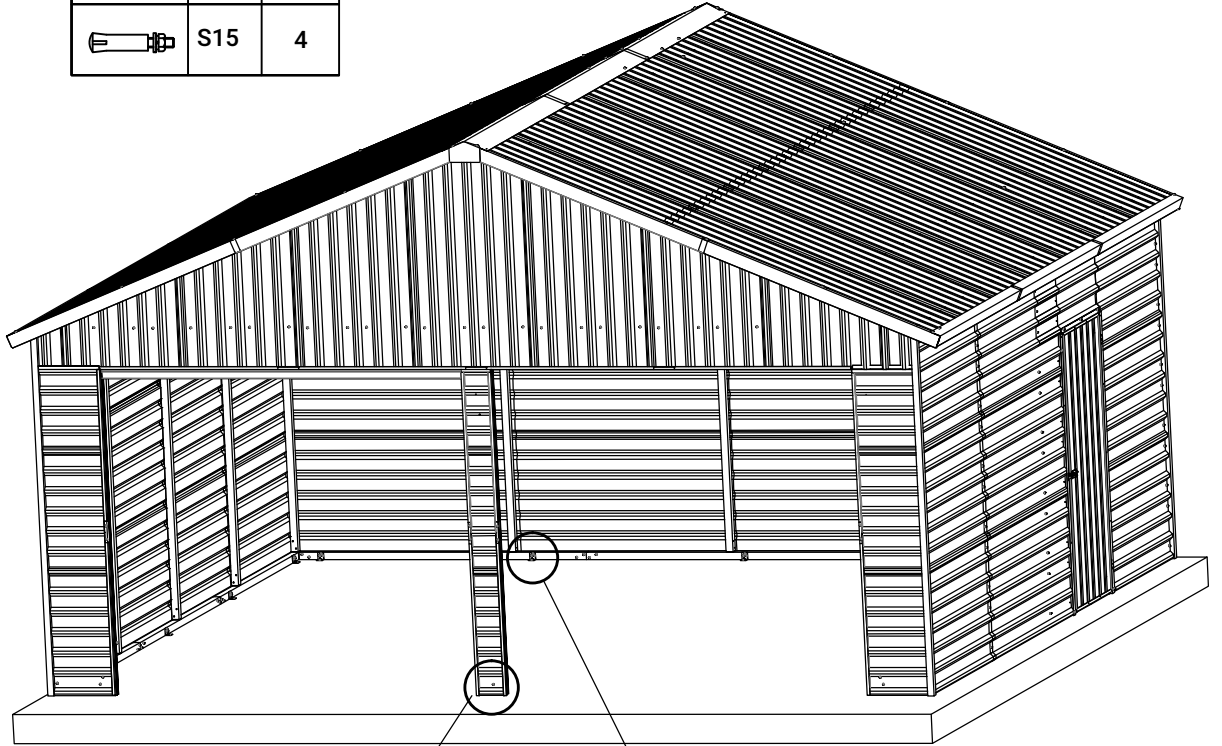
	C72	14		S12	42
	S11	14			
	S15	4			





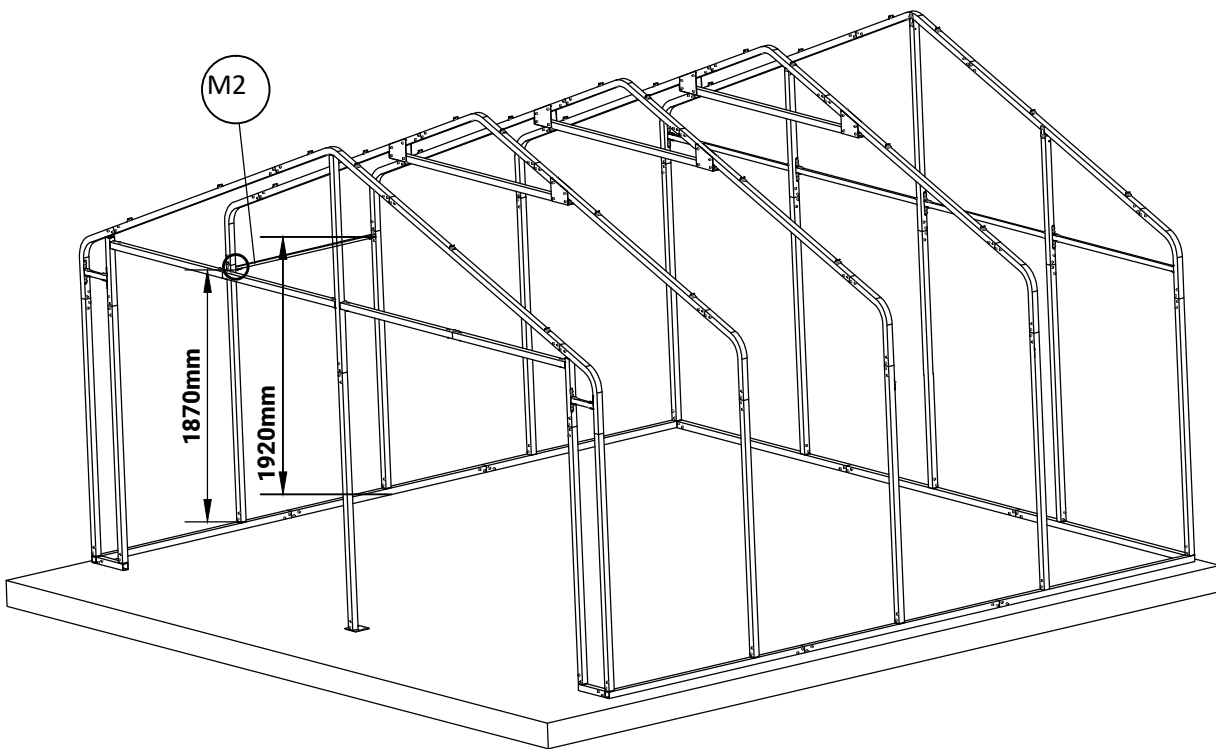
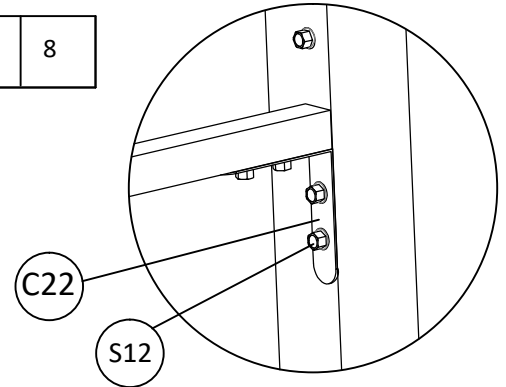

If you want to install the side door on the left, please follow the steps on this page.

	M2	1		C22	2		S12	8
---	----	---	---	-----	---	---	-----	---



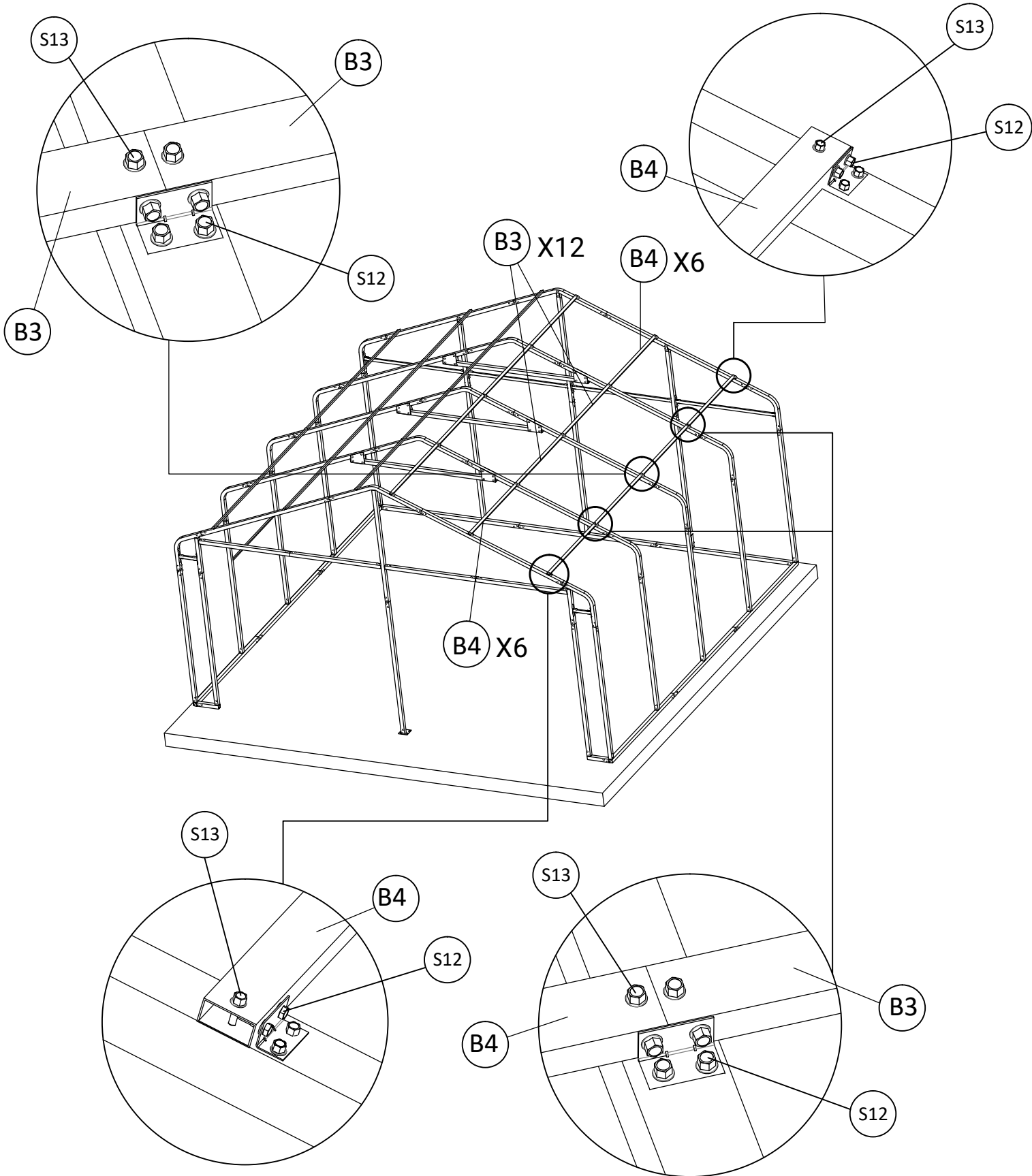

Frame Assembly - Beam Part

	B4	12		B3	12		S12	60		S13	48
---	----	----	---	----	----	---	-----	----	---	-----	----



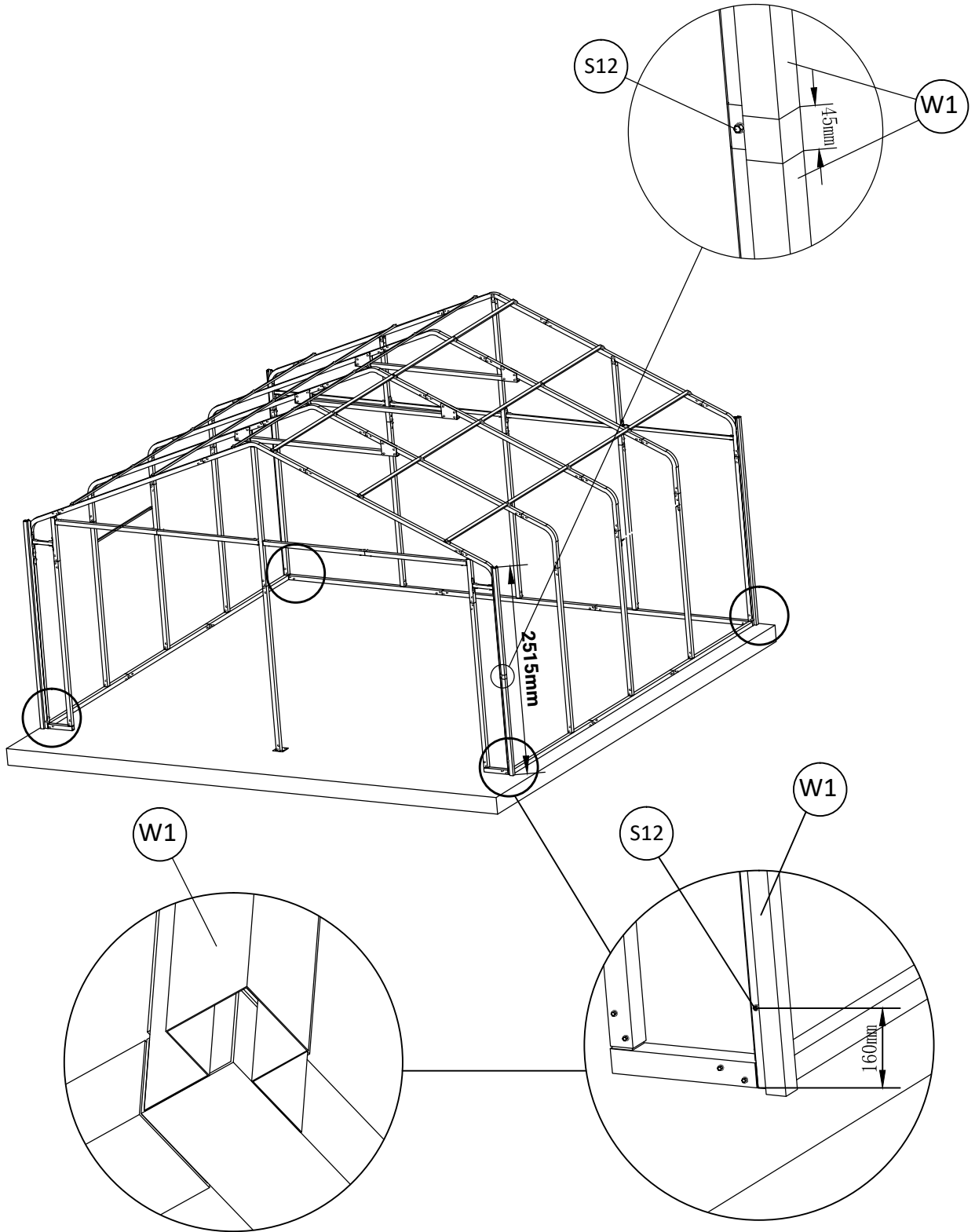

Frame Assembly

	W1	8		S12	16
---	----	---	---	-----	----

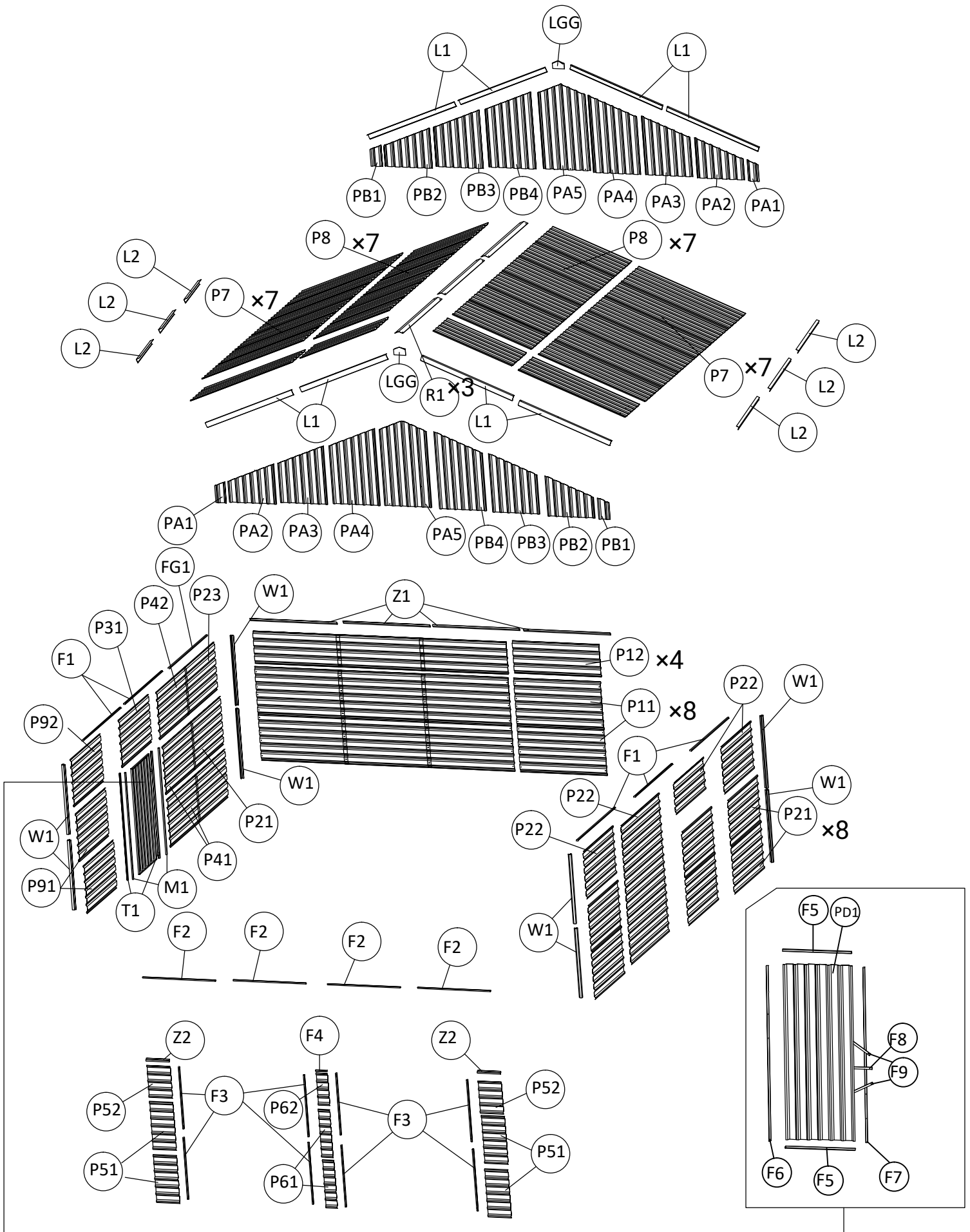





Panel Assembly - Back Wall

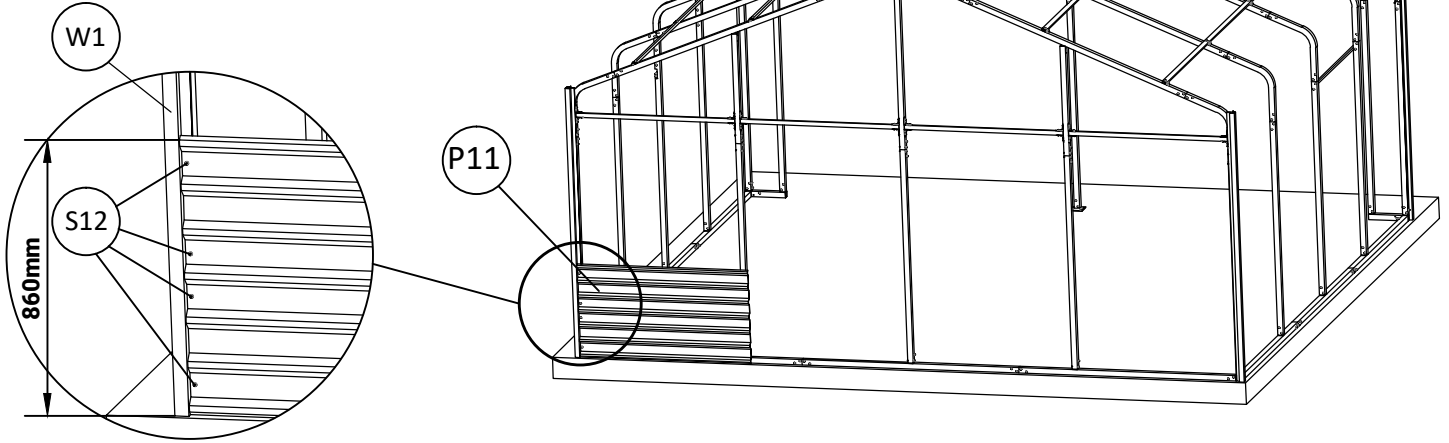

	P11	1		S12	4
---	-----	---	---	-----	---



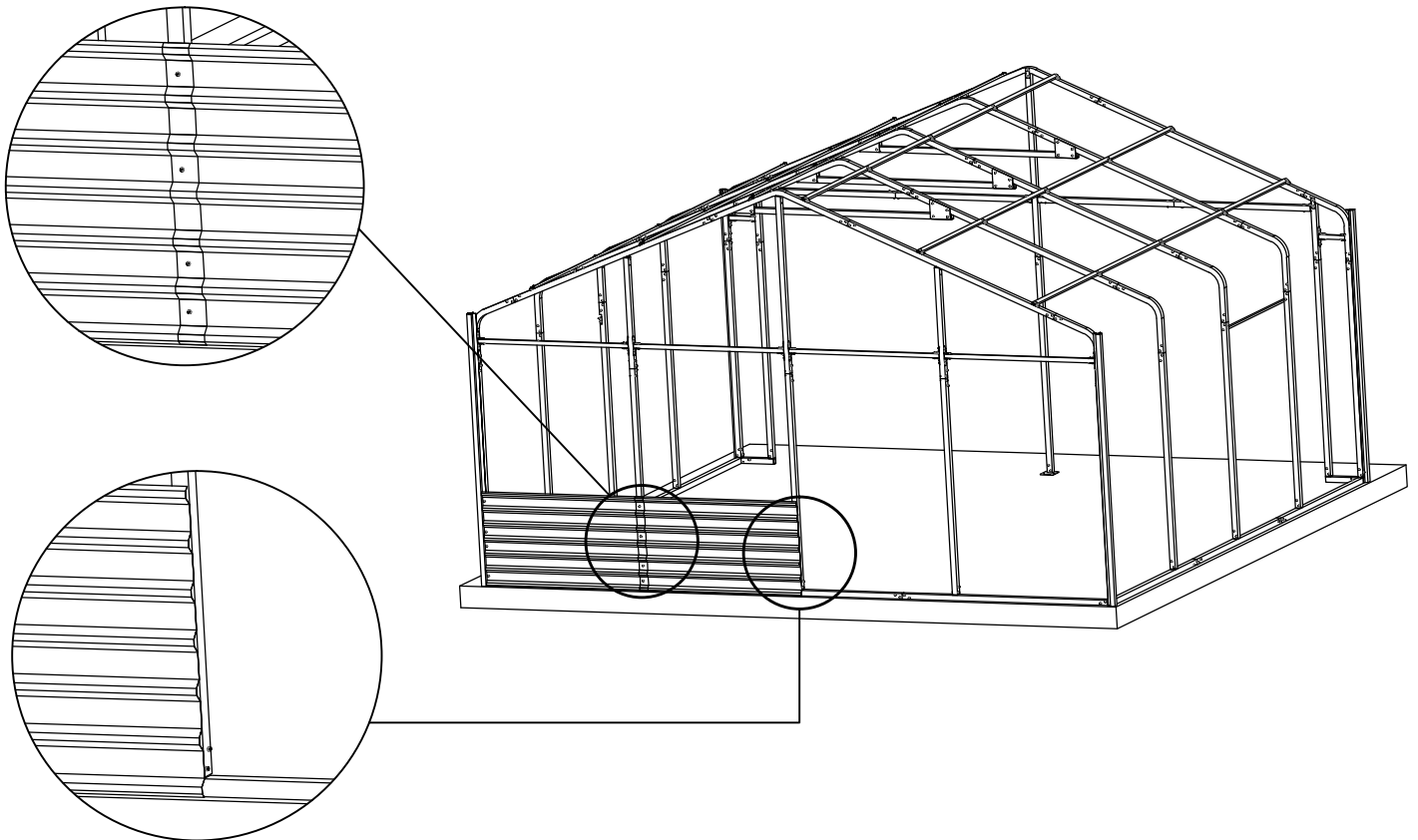

	P11	1		S12	4
--	-----	---	--	-----	---

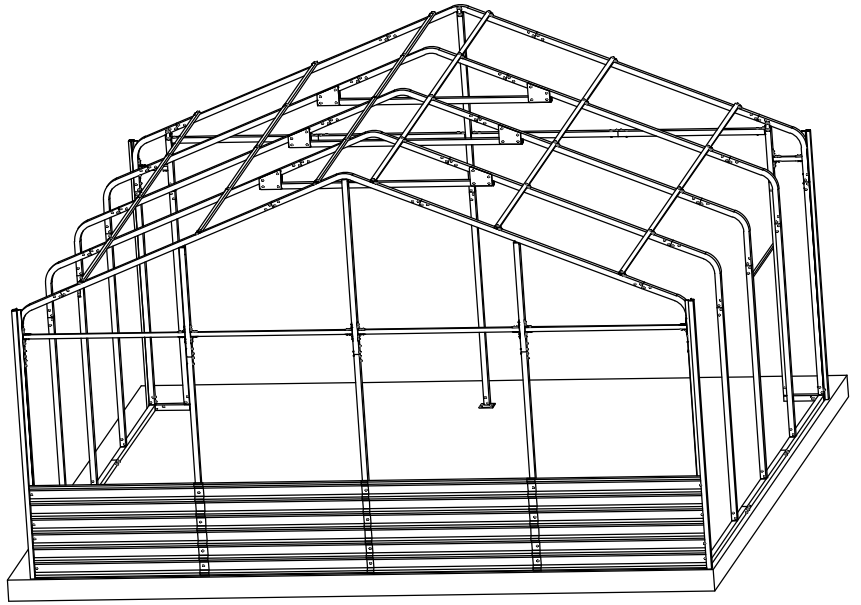

Panel Assembly - Back Wall

	P11	2		S12	12
---	-----	---	---	-----	----





	P11	4		S12	20
--	-----	---	---	-----	----

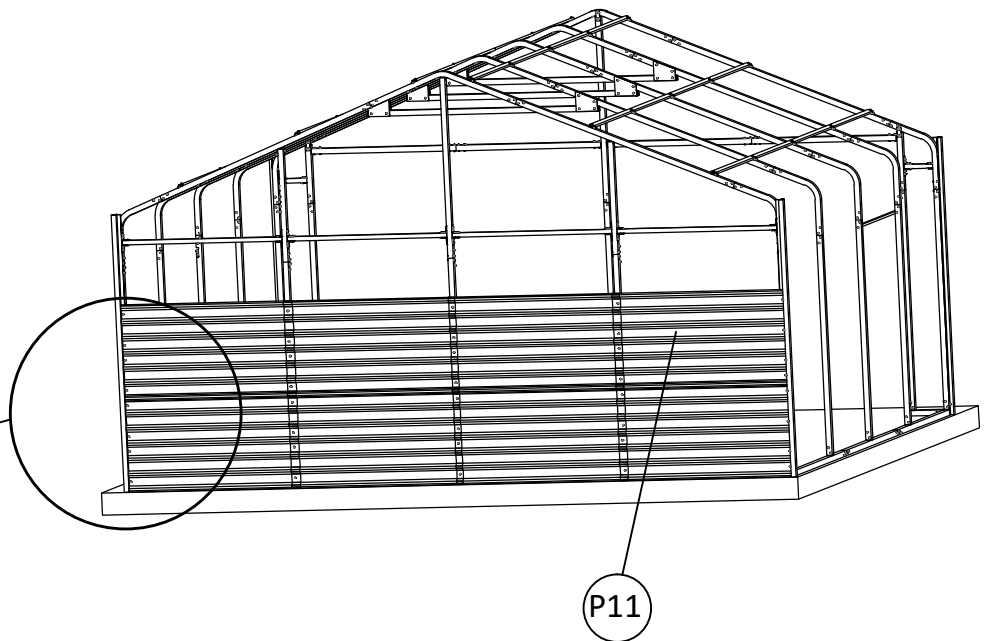
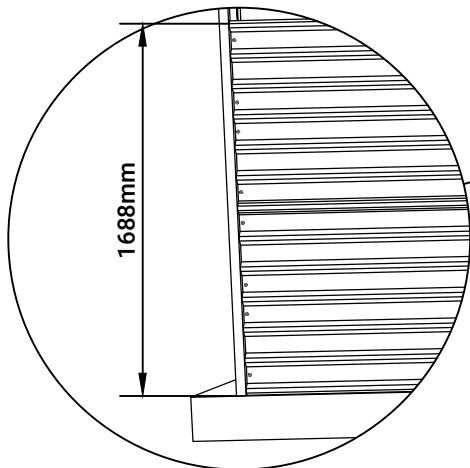
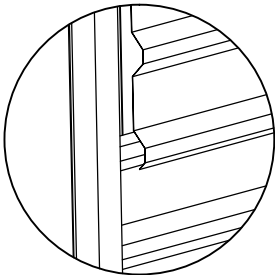

When two panels overlap, make sure upper panel covers the lower panel.



Panel Assembly - Back Wall

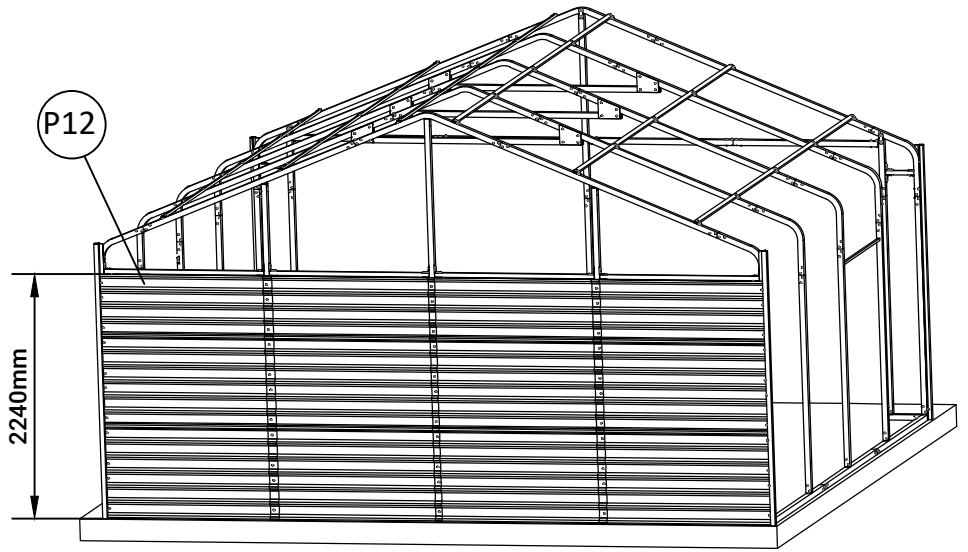
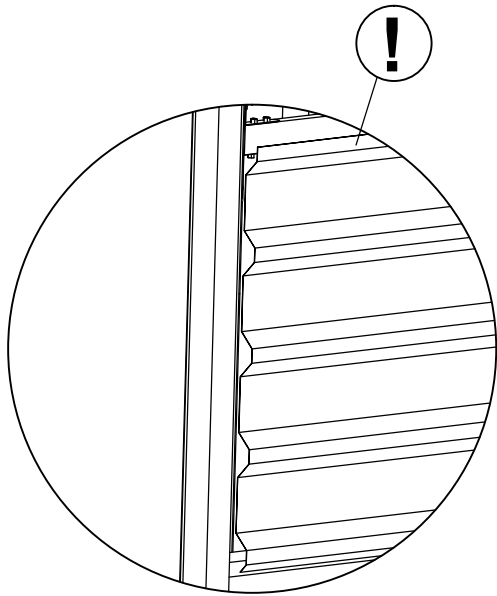

	P12	4		S12	20
---	-----	---	---	-----	----



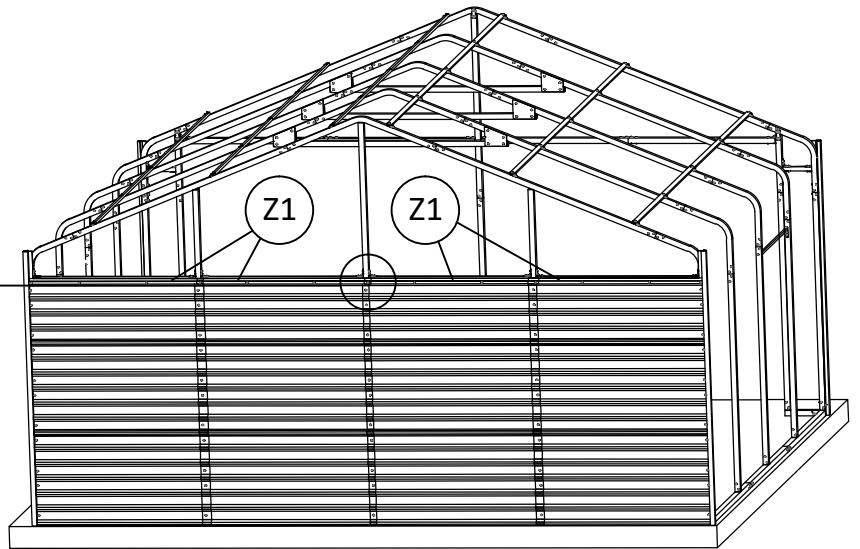
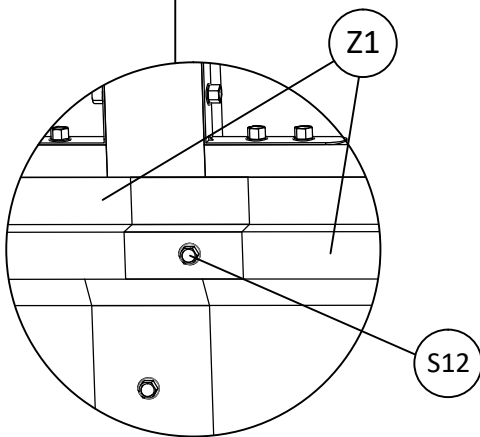
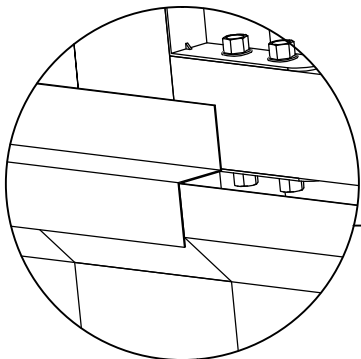

	Z1	4		S12	13
---	----	---	---	-----	----



Panel Assembly - Right Wall

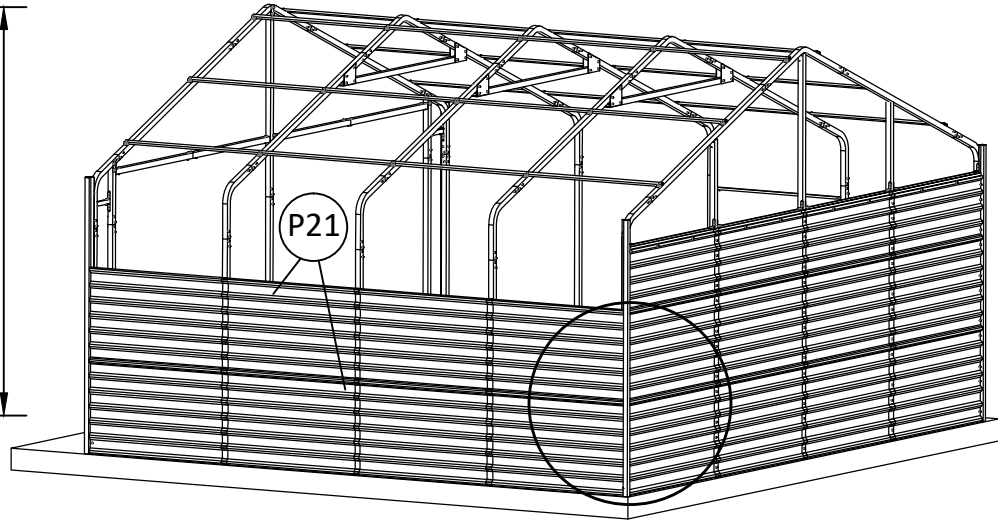
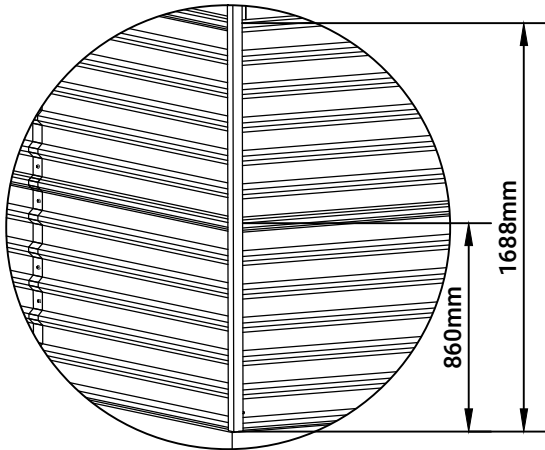

	P21	8		S12	40
---	-----	---	---	-----	----



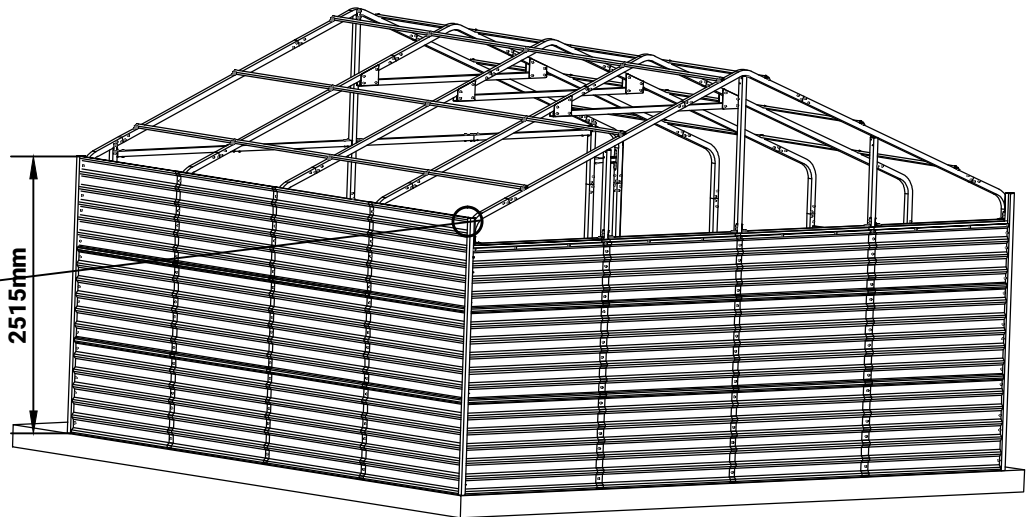
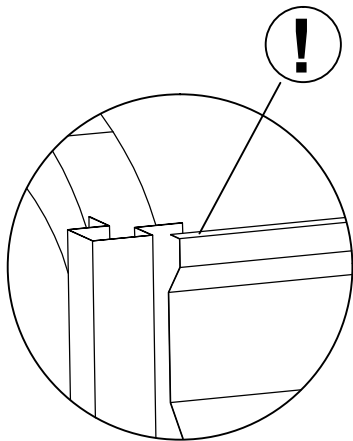



	P22	4		S12	20
---	-----	---	---	-----	----

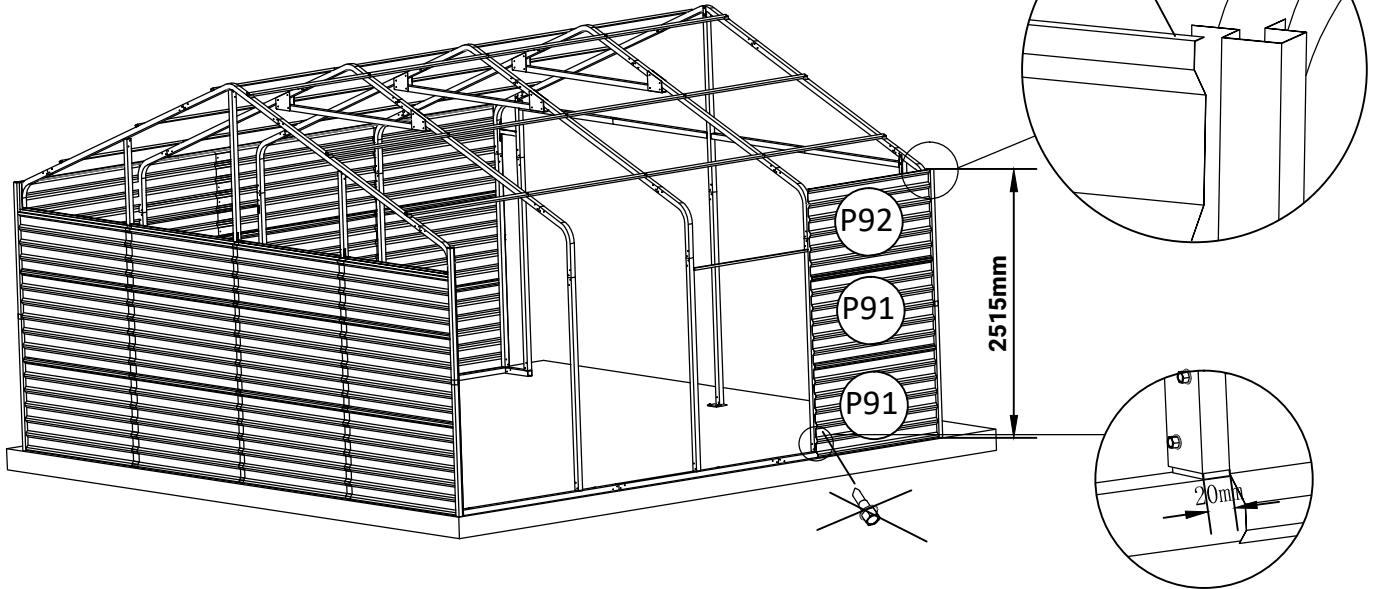

Panel Assembly - Left Wall

	P91	2		P92	1		S12	12
---	-----	---	---	-----	---	---	-----	----



	T1	1		M1	1		S13	5		S12	5
---	----	---	---	----	---	---	-----	---	---	-----	---

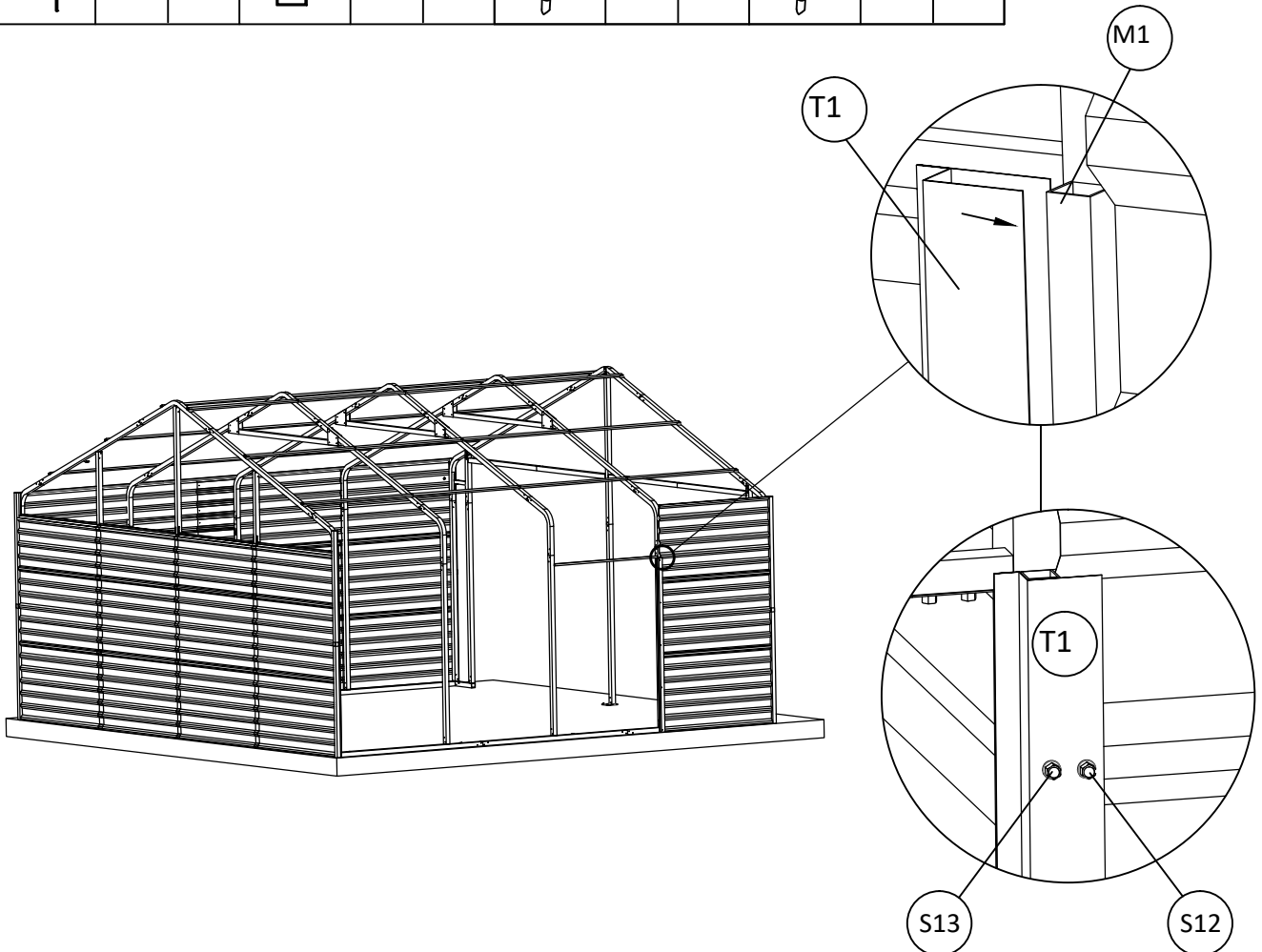

Panel Assembly - Left Wall

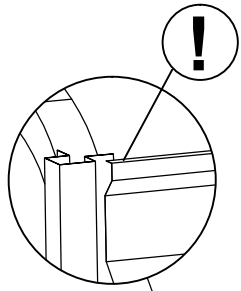



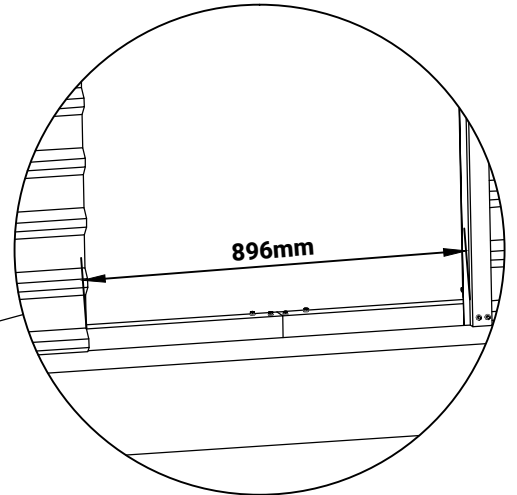
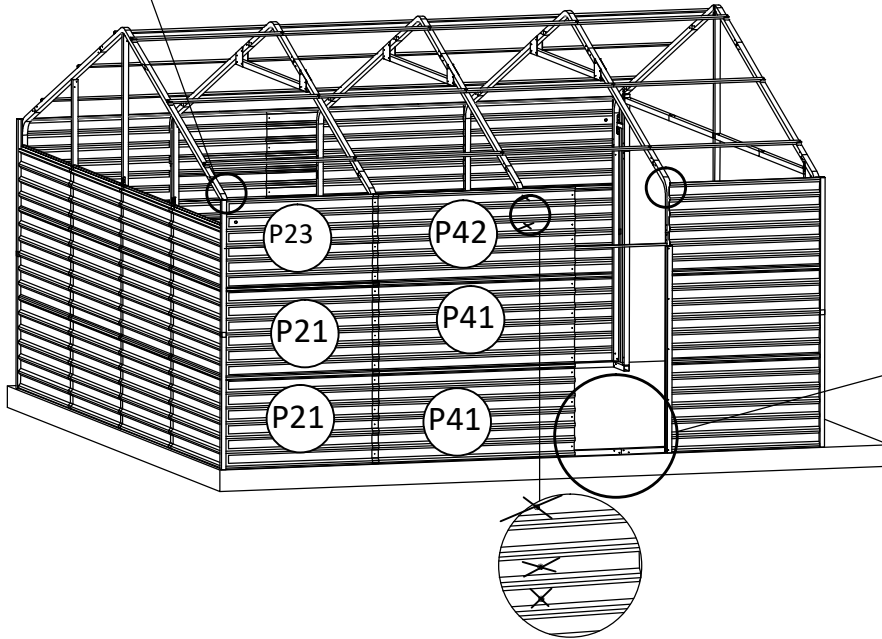
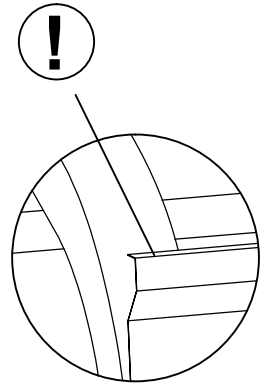

	P41	2		P42	1		S12	33
	P21	2		P23	1			

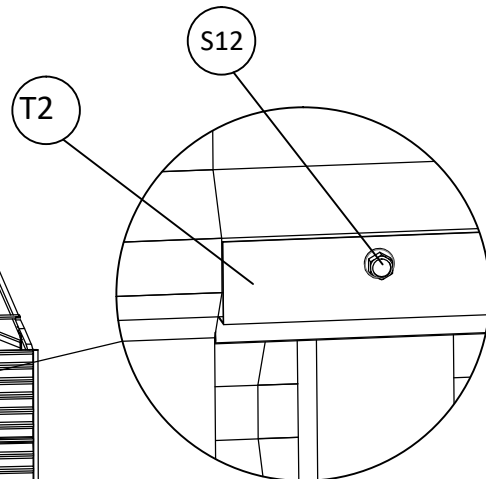
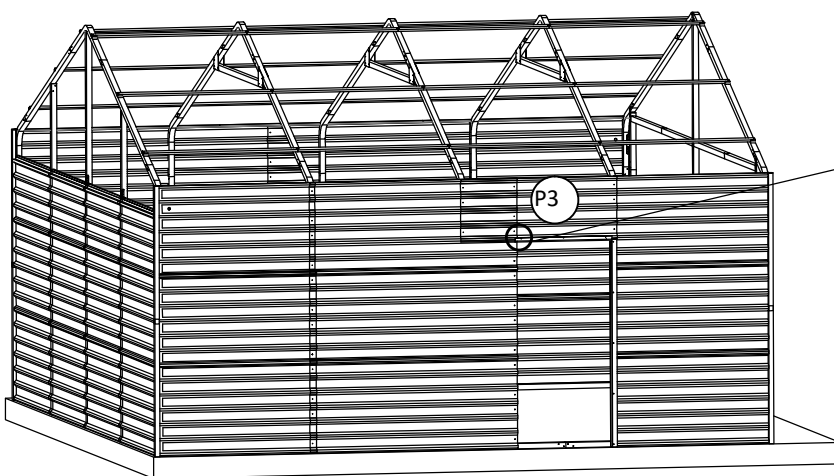

	P3	1		S12	9		T2	1
--	----	---	--	-----	---	--	----	---



For next step, please refer to page 31.

	T1	1		S12	8		S13	2
	M1	1						

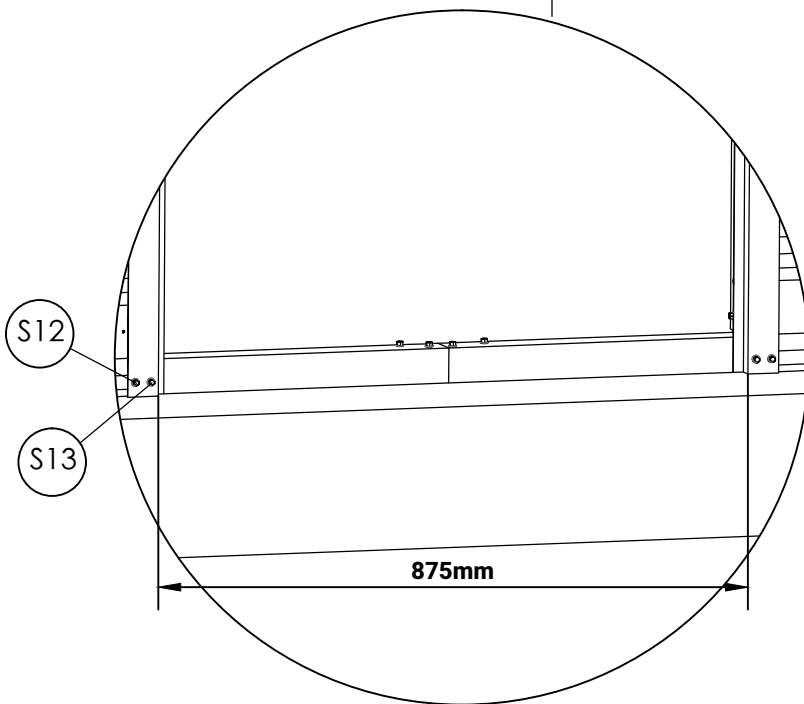
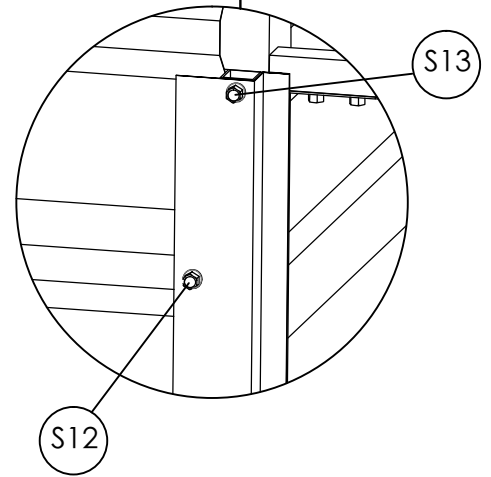
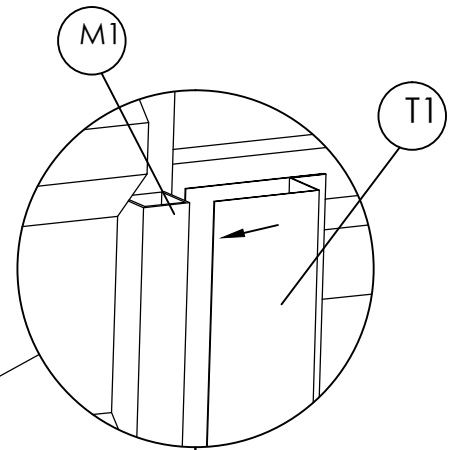
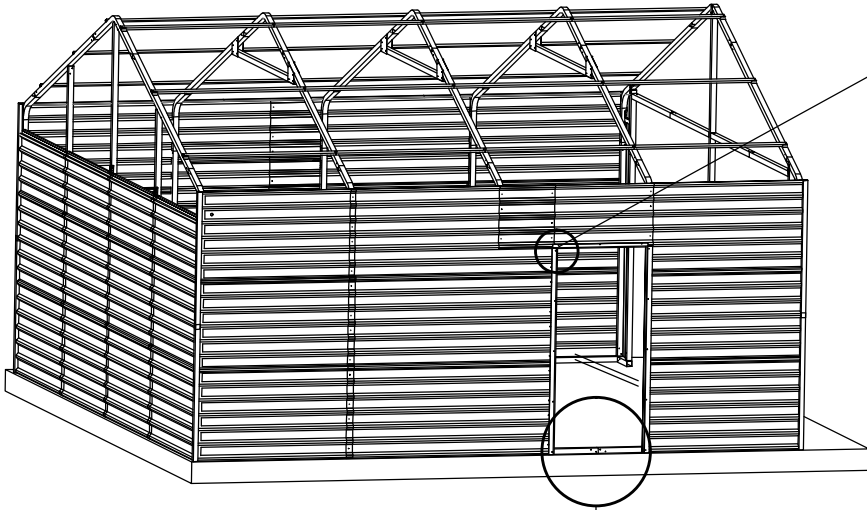

WARRANTY INFORMATION:

Please refer to our website for detailed warranty conditions and coverage. For the most up-to-date and comprehensive warranty information, visit www.tmgindustrial.com