

8' x 9' METAL PENT SHED WITH SKYLIGHT

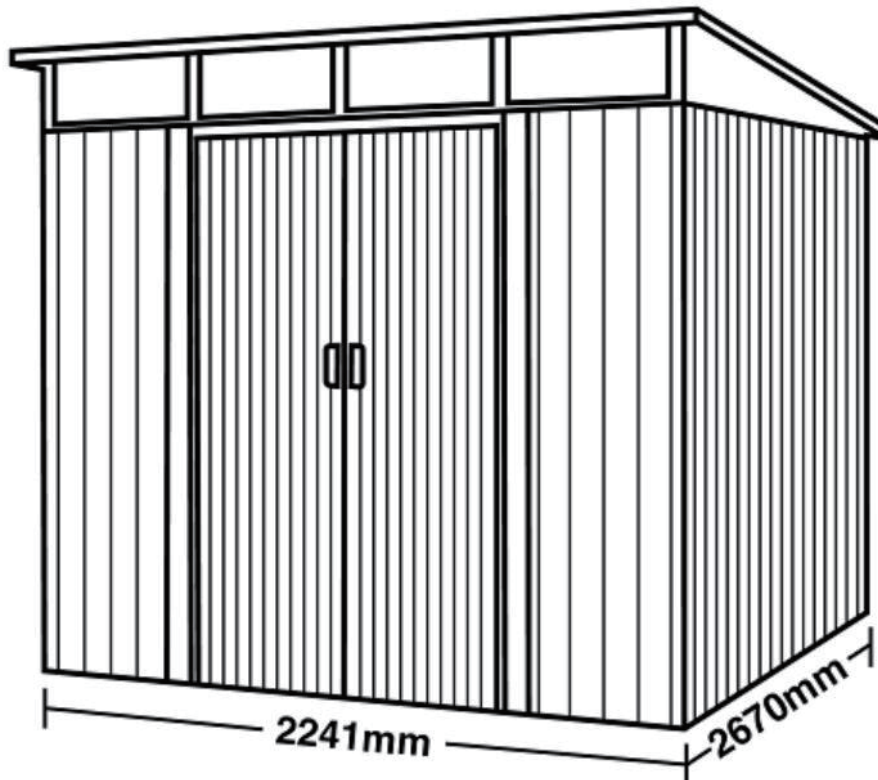

⚠ WARNING

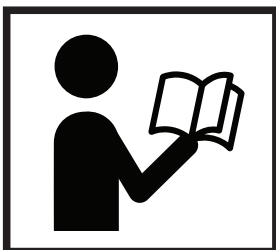

This structure is intended for temporary outdoor storage use only. It is not designed to withstand heavy snow and wind loads and does not come with engineering drawings. To ensure suitability for your specific weather needs, it is your responsibility to verify their appropriateness for your intended use and local weather conditions, especially in areas prone to severe weather.

- Please read and understand the product manual completely before assembly
- Check against the parts list to make sure all parts are received
- Wear proper safety goggles or other protective gears while in assembly
- Do not return the product to dealer. They are not equipped to handle your requests.

Missing parts or have questions on assembly?

Please call: 1-877-761-2819 or email: cs@tmgindustrial.com

BEFORE YOU START

Owner's Manual

Prior to installation, it is important that you contact your local government authority to determine if building approval is required. Study and understand this owner's manual. Important information and helpful tips will make your construction easier and more enjoyable.

Assembly instructions

Instructions are supplied in this manual and contain all appropriate information for your building model. Review all instructions before you begin. During assembly, follow the step sequence carefully for correct results .

Parts

Check to be sure that you have all the necessary parts for the building. Separate contents of the carton by the part number while reviewing parts list. Familiarize yourself with the hardware and fasteners for easier use during construction. These are packaged within the carton. Note that extra fasteners have been supplied for your convenience.

TOOLS MAY REQUIRED



Ø2.4&Ø5

5.5X7

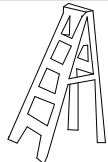
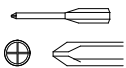
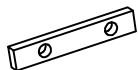

PH1

Use heavy duty gloves when handling steel sheets and flashing

PLAN AHEAD

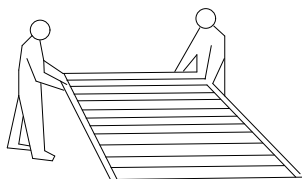

Watch the weather:

Please be sure the day you select for installation is dry and calm. **DO NOT attempt to assemble your shed in windy weather** because of risk of damage to panels, or personal injury. Be careful of wet or muddy ground.

Teamwork:

Whenever possible, two or more people should work together to assemble the building. One person can position parts or panels while the other is able to handle the fasteners and the tools.

PLAN AHEAD

Site Selection

- Avoid overhanging trees as much as possible as leaves will make regular cleaning necessary and broken branches are a potential hazard.
- Small trees, bushes or fences nearby can be helpful, acting as a wind break.

Site Preparation

The site must be prepared so that the base of the shed is level all round and checking with a spirit level is required.

The base can be constructed by treated timber or concrete, in order to stop the moisture getting into the shed. **The shed is not designed to be built onto lawn directly.** Also the ground will get muddy during rainy days.







If a concrete pad is made, it is important that this slopes towards the edges to prevent water ingress.

Time must be allowed for any concrete or cement to dry before building the shed on top.

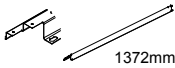

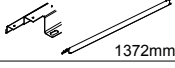
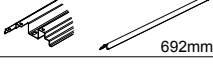
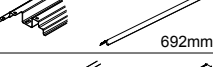
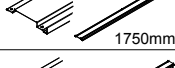
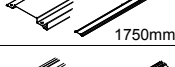
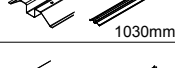
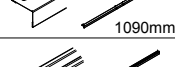

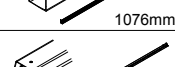
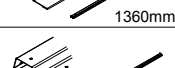
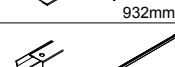
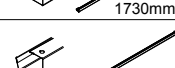

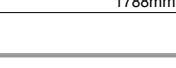
Bases can also be constructed from bricks, blocks, or mounted on a concrete pad. The bricks or blocks should be cemented onto firm and level concrete footings and the greenhouse frame drilled and screwed to the base.

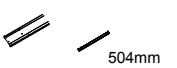
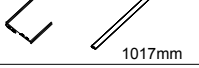
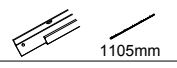
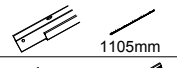
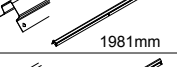
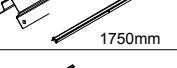
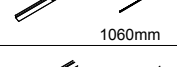
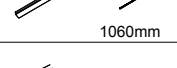
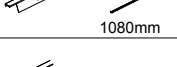
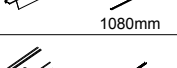
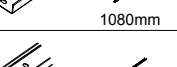
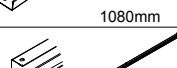
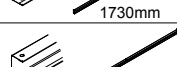
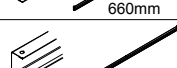
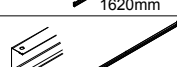
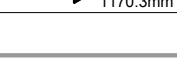

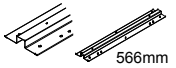
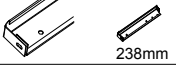
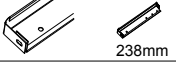
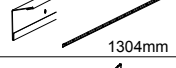

IMPORTANT NOTES:

- Find someone to help you: it is much easier with someone to hold parts, pass tools ect. Also some steps require two people to lift structures together. This is not very heavy work so would suit most able-bodied people.
- Allow plenty of time: rushing often causes errors and the re-doing of incorrect assemblies. If you have never built a shed before, it can take most of a day to carefully complete the construction.
- Have the right tools to hand.
- Safety clothing as recommended in the 'Tools' section.
- Ideally lay out the parts and check that all are present before commencing construction. Lay on cloths or plastic sheets if there is any risk of scratching the parts.
- Tighten all nuts carefully, being sure not to miss any. Check the frame is square and using a spirit level to check that it is upright.

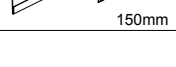

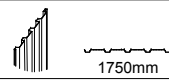



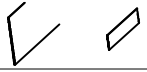
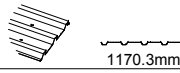
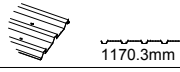
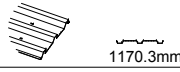

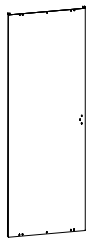
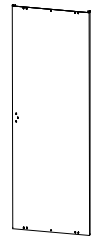

NO.	PART	Qty.
1	 1372mm	4
1-1	 944mm	1
2	 1372mm	1
3L	 692mm	1
3R	 692mm	1
4L	 1750mm	1
4R	 1750mm	1
5	 1030mm	1
6	 1090mm	1
7L	 1076mm	1
7R	 1076mm	1
9	 1360mm	1
9-1	 932mm	1
10	 1730mm	1
10-1	 660mm	1
11	 1788mm	2

NO.	PART	Qty.
11-1	 504mm	2
11-2	 1017mm	1
12L	 1105mm	1
12R	 1105mm	1
13	 1981mm	2
13-1	 1750mm	2
14L	 1060mm	1
14R	 1060mm	1
15L	 1080mm	1
15R	 1080mm	1
16L	 1080mm	1
16R	 1080mm	1
17	 1730mm	1
17-1	 660mm	1
17-2	 1620mm	2
17-3	 1170.3mm	2

NO.	PART	Qty.
18	 566mm	6
19L	 238mm	1
19R	 238mm	1
20	 1304mm	4
21L		1
21R		1
22	 233mm	2
22L		1
22R		1
B1	 86mm	2
B2	 150mm	2

NO.	PART	Qty.
P1	 1750mm	19
P2	 1746mm	2
P3	 1746mm	3
P4	 1746mm	1
P5		2
P6	 1170.3mm	2
P7	 1170.3mm	3
P8	 1170.3mm	1

NO.	PART	Qty.
D1	 1740X570mm	1
D2	 1740X570mm	1

NO.	PART	Qty.
G2		4
GD		4
GS		2
GB		2
GC		4
F1		370
F2		68
F3		8
S2		220
S3		324

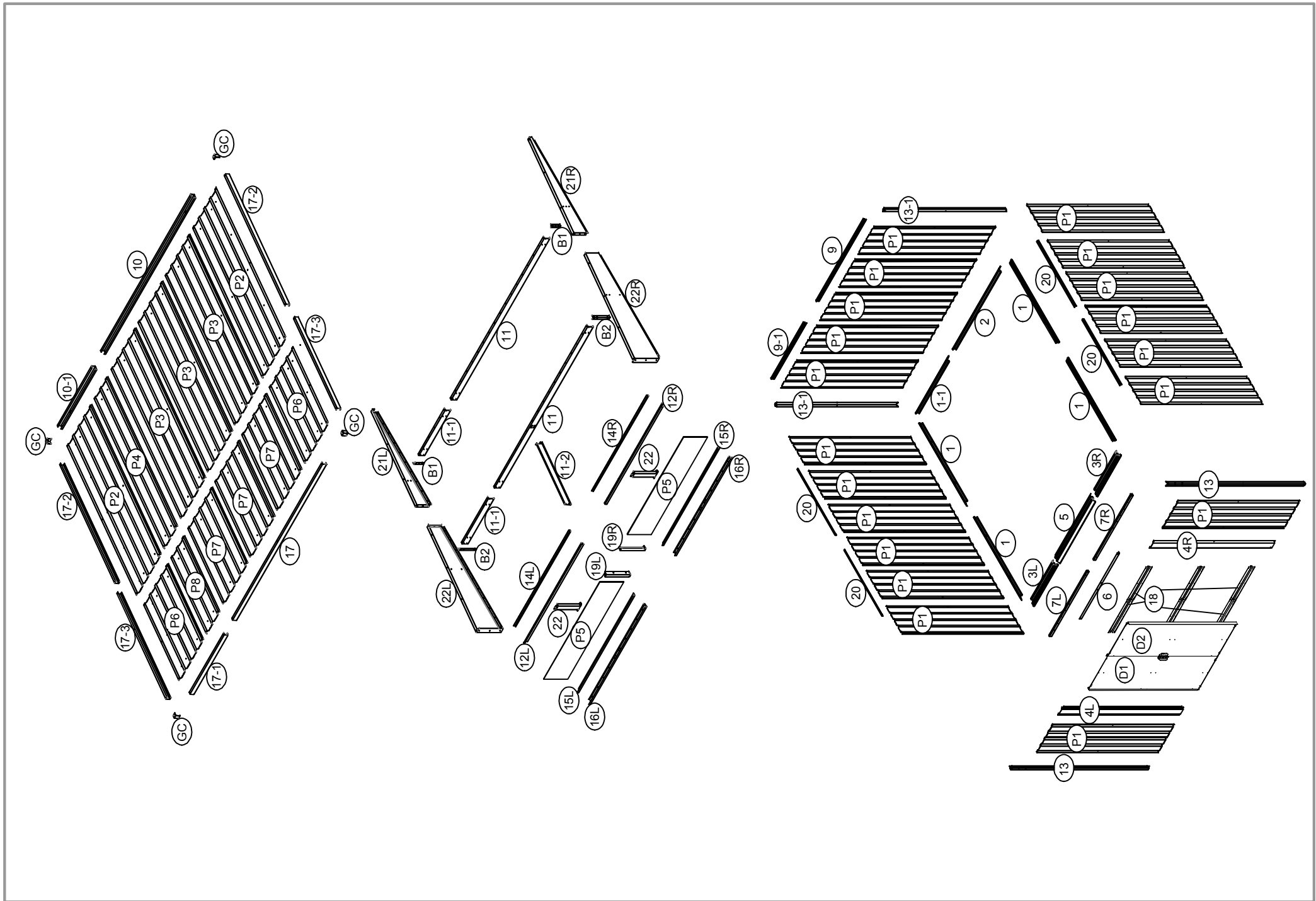

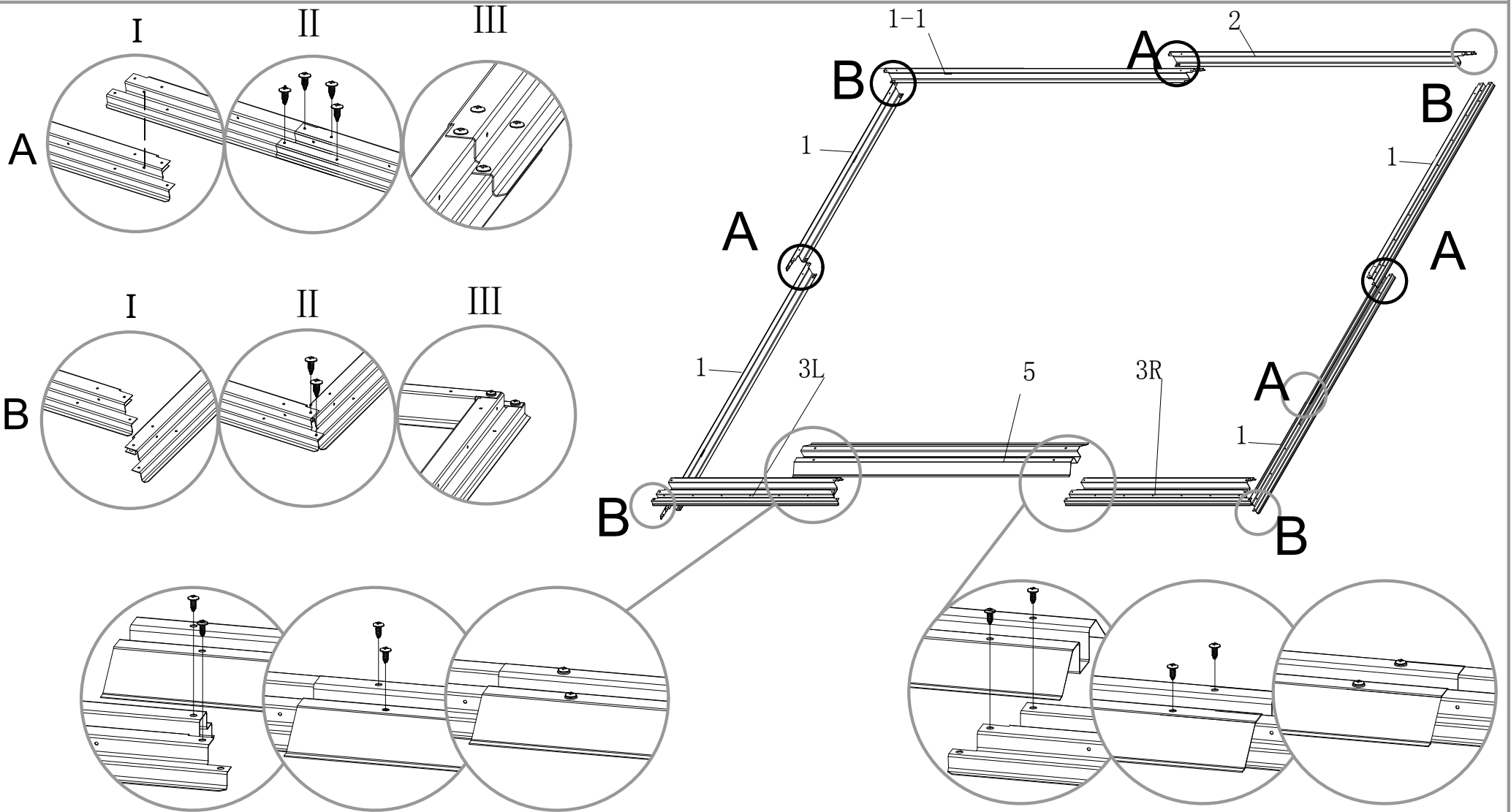
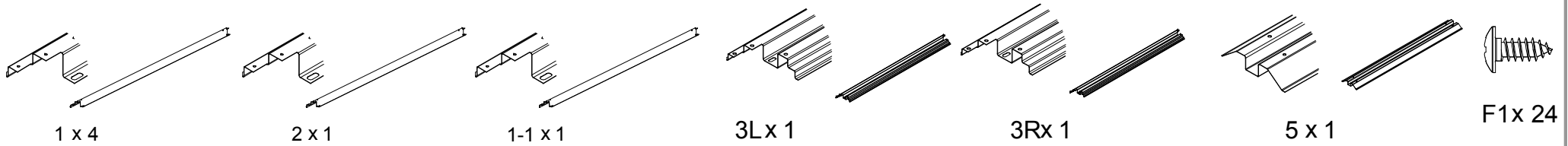

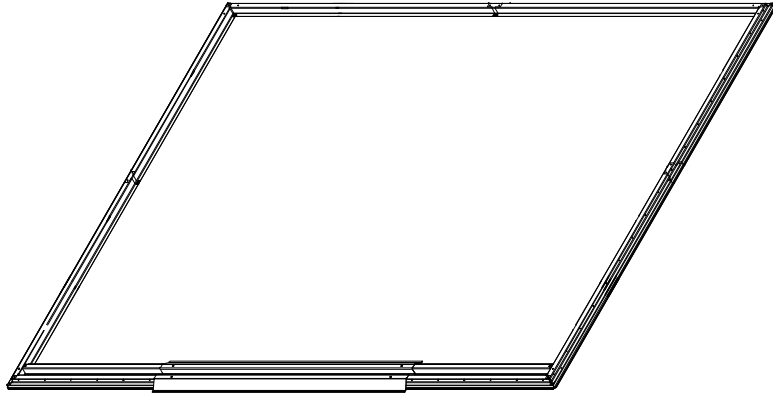

1、 When diagonal measurements are equal, the frame is square.

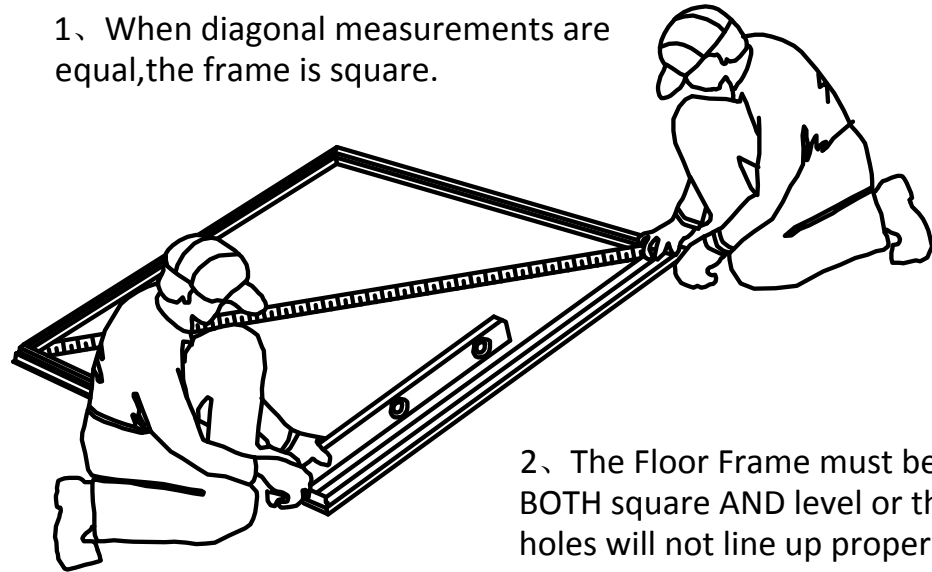

2、 The Floor Frame must be BOTH square AND level or the holes will not line up properly.

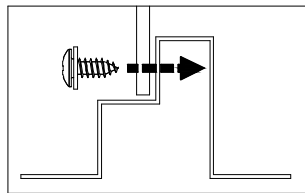
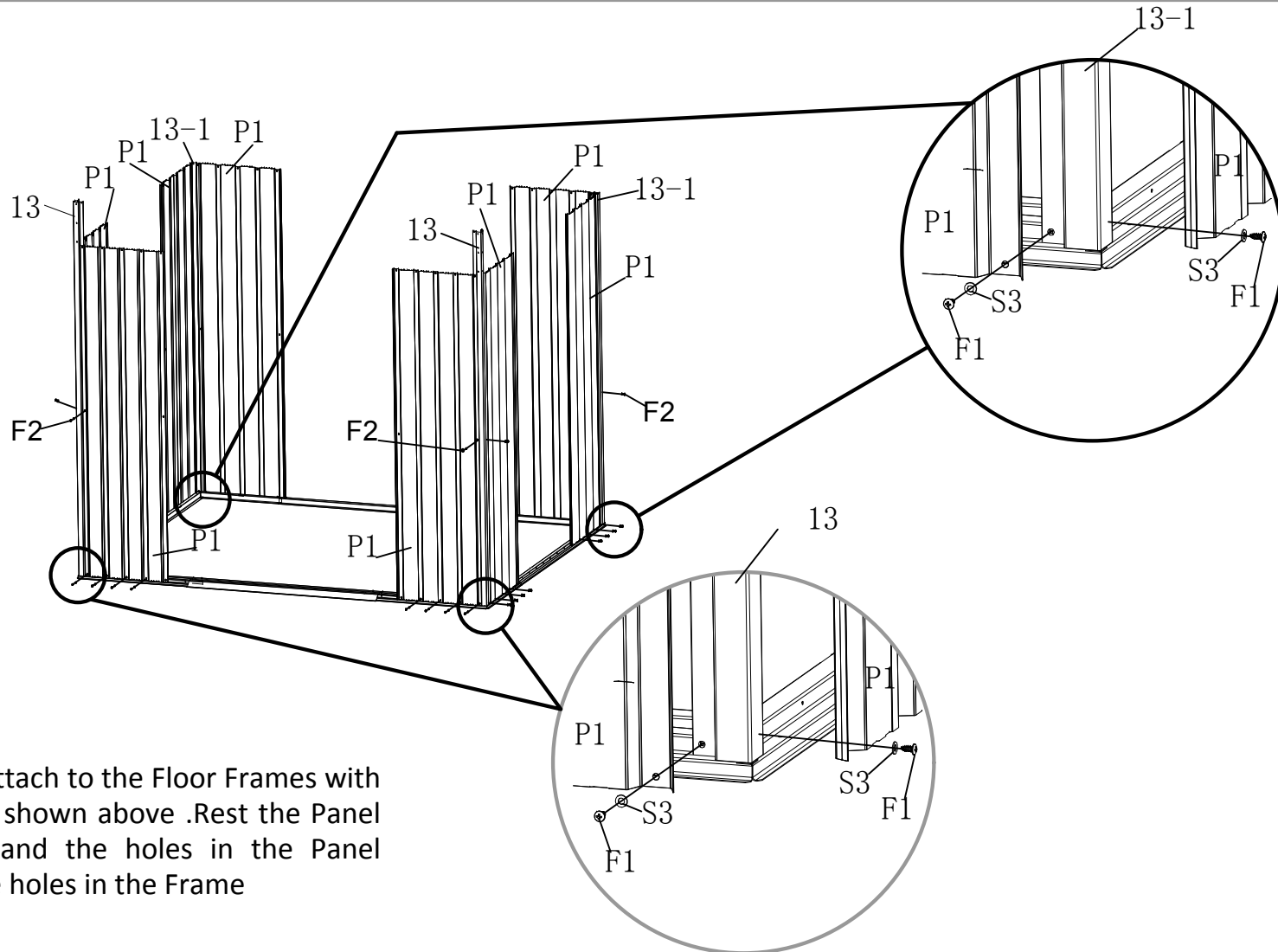
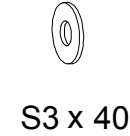
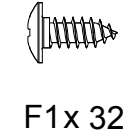
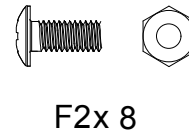
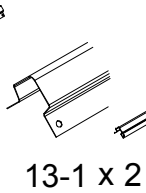
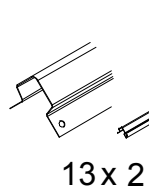
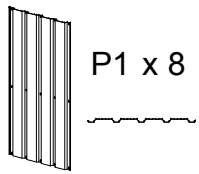

Wall panels ALWAYS attach to the Floor Frames with Screws in the manner shown above .Rest the Panel on the Floor Frame and the holes in the Panel should line up with the holes in the Frame

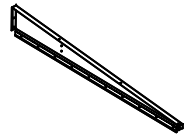

21Lx1

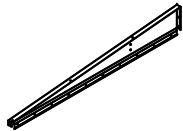

21Rx1

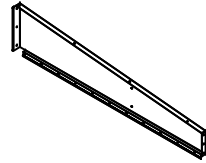

22Lx1

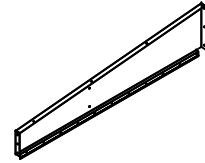

22Rx1

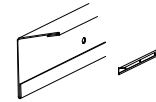

B1x 2

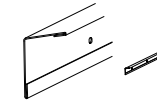

B2x 2

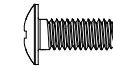

F2x 18



S3 x 12

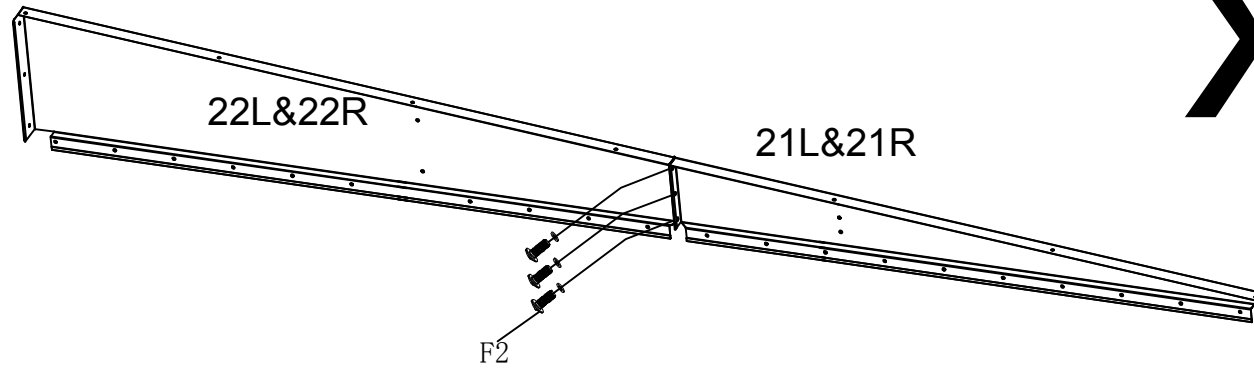

x2

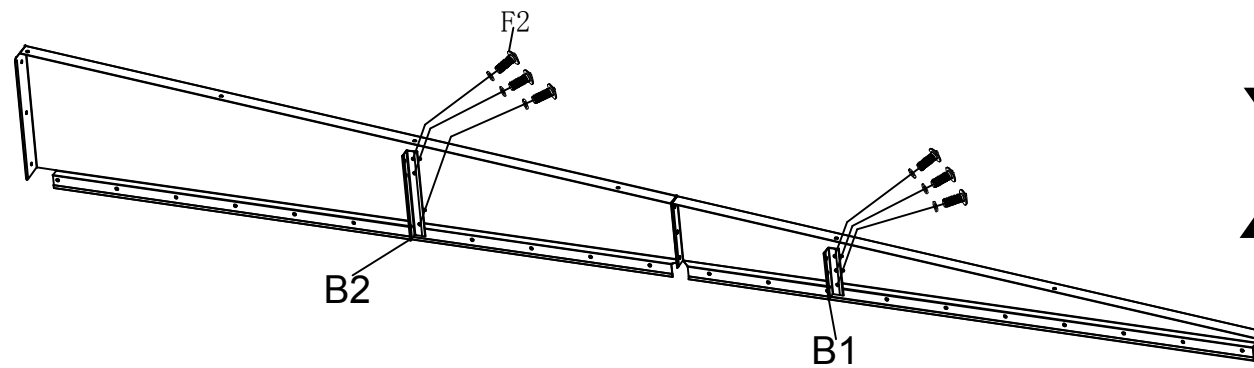

x2

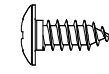
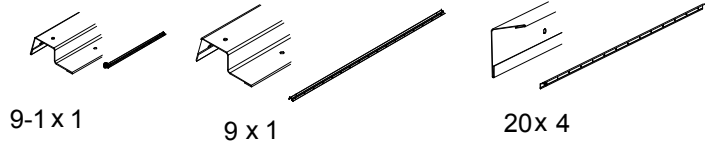

F1 x 28



S3 x 26

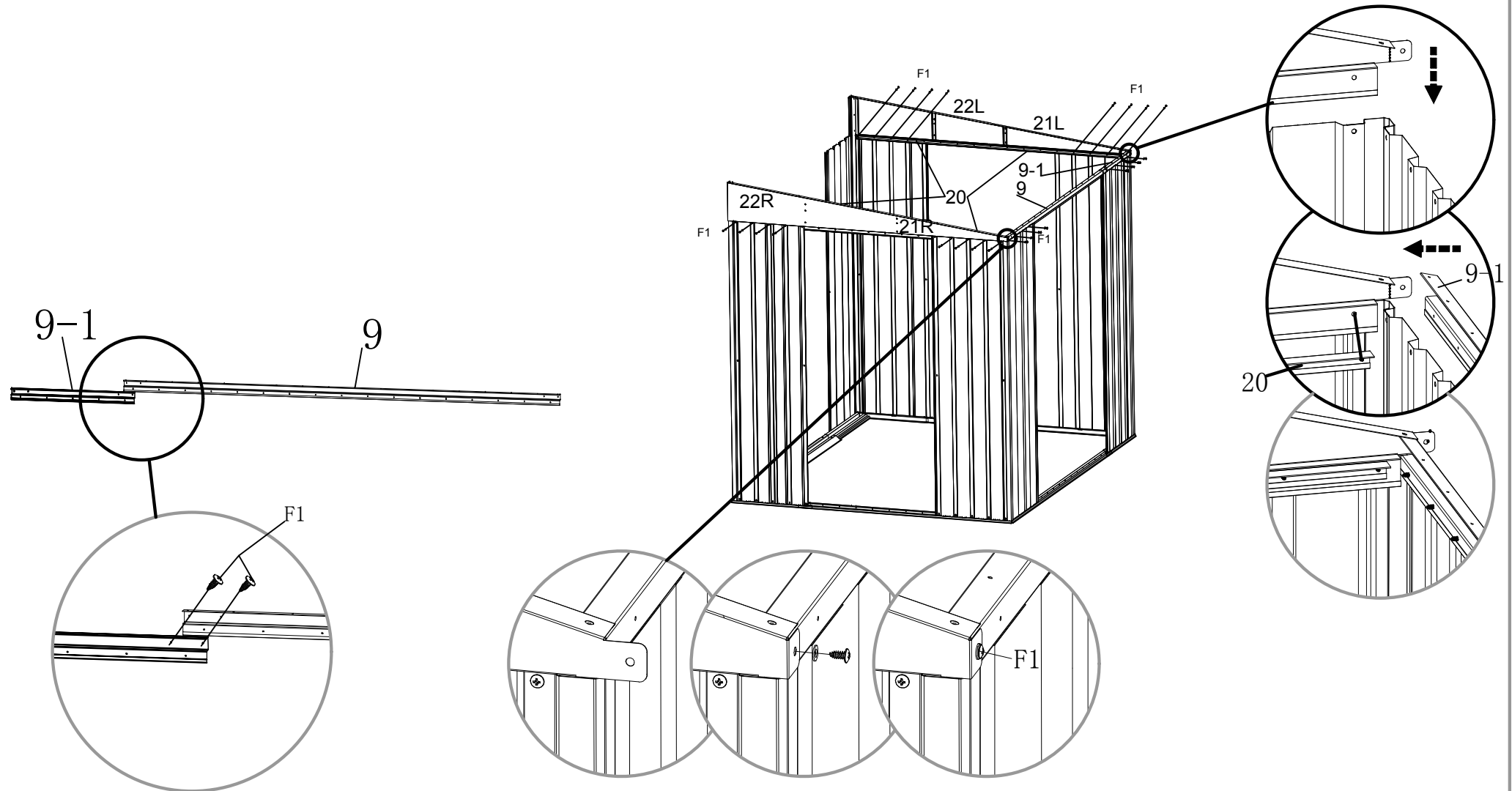

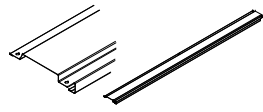

4L x 1

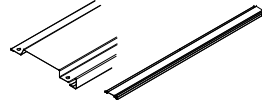

4R x 1

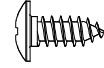

F1 x 4



F2 x 2



S3 x 6

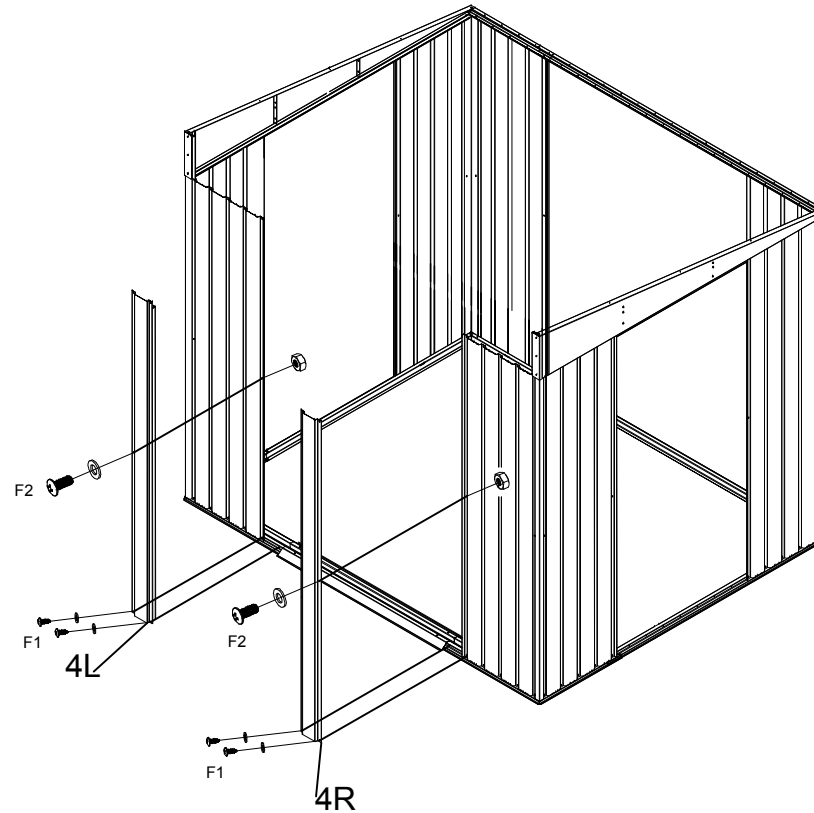

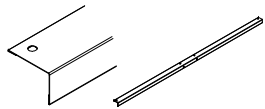

6 x 1



7Lx1



7Rx1

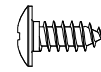

F1 x 2



S3 x 2

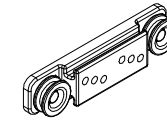

G2x4

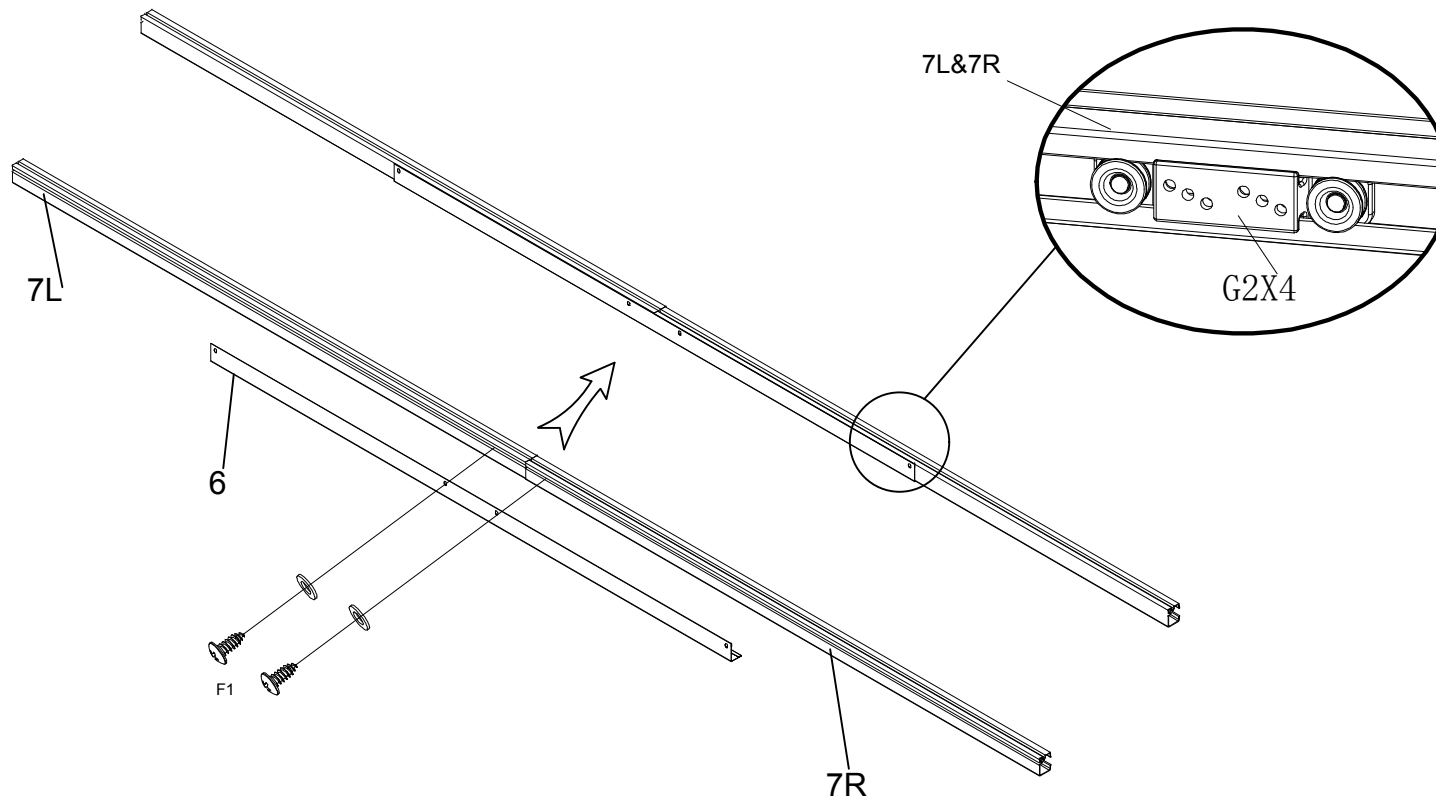

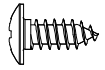

F1 x 12



S3 x 12

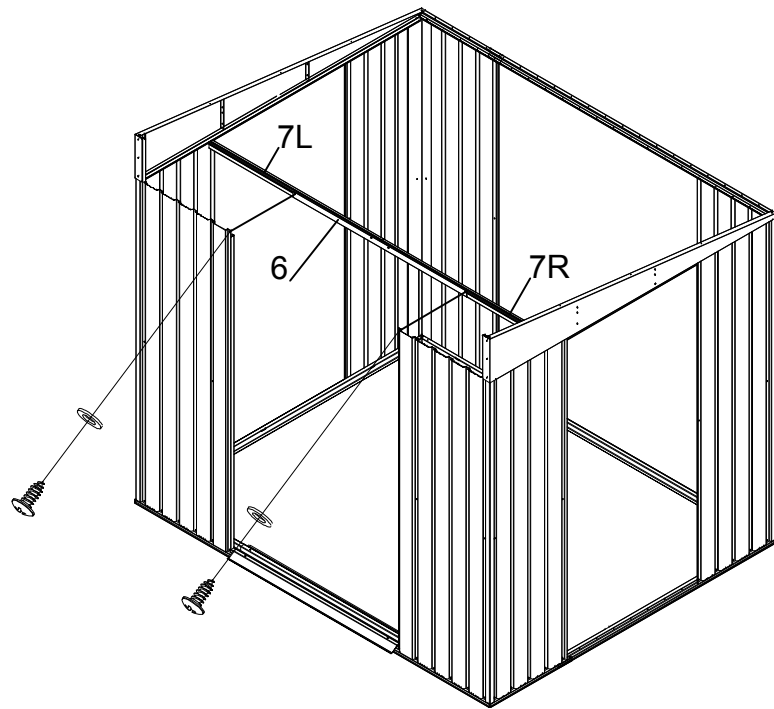

I

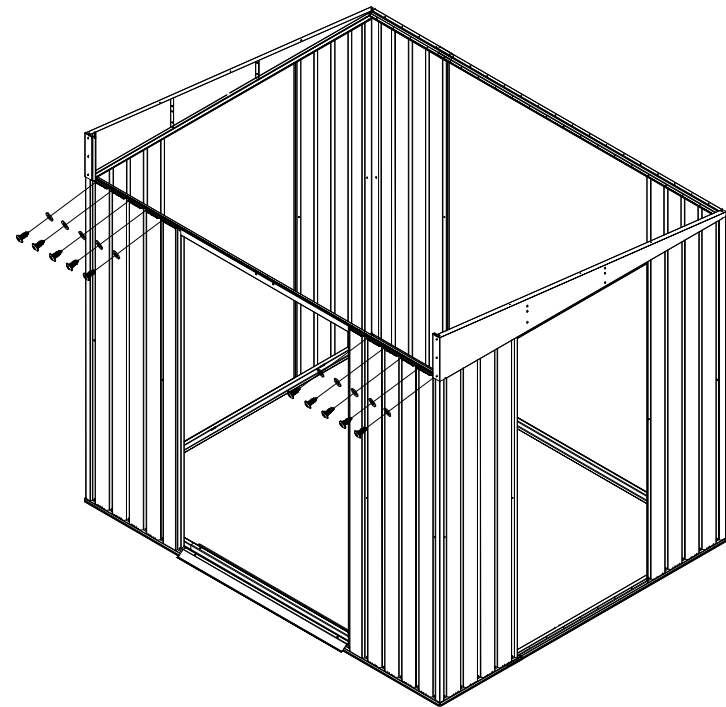

II

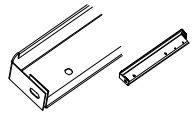

19Rx 1

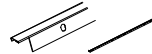

15Rx 1

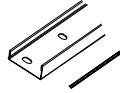

16Rx 1

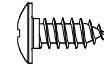

F1 x 1

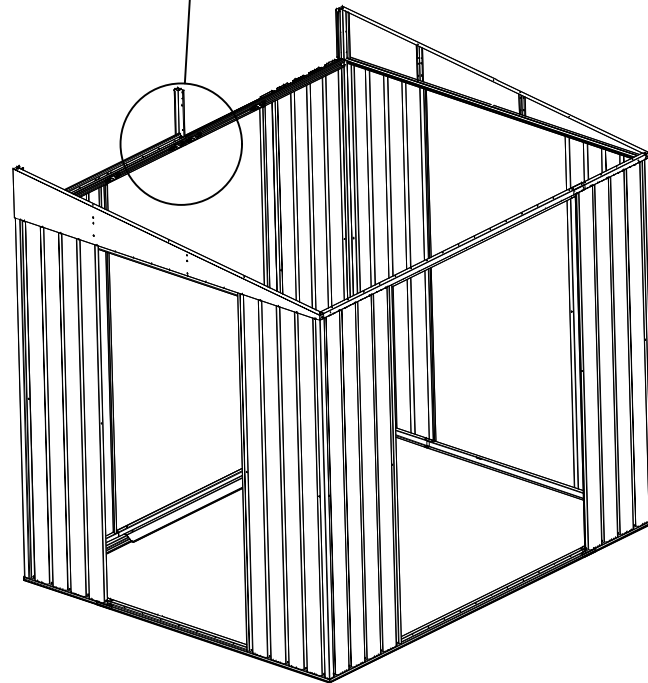
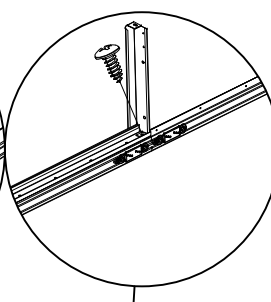
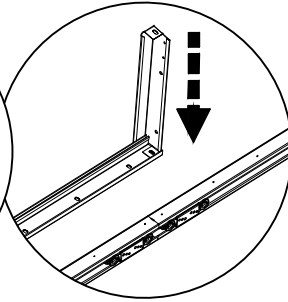
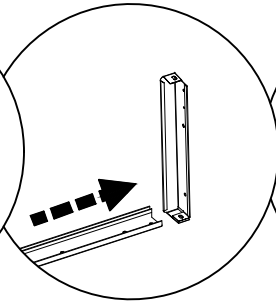
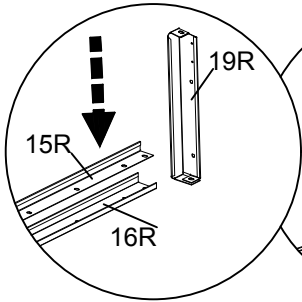

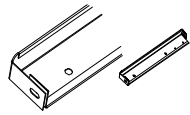

19L x 1

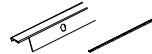

15L x 1

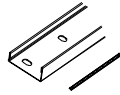

16L x 1

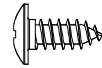

F1 x 1

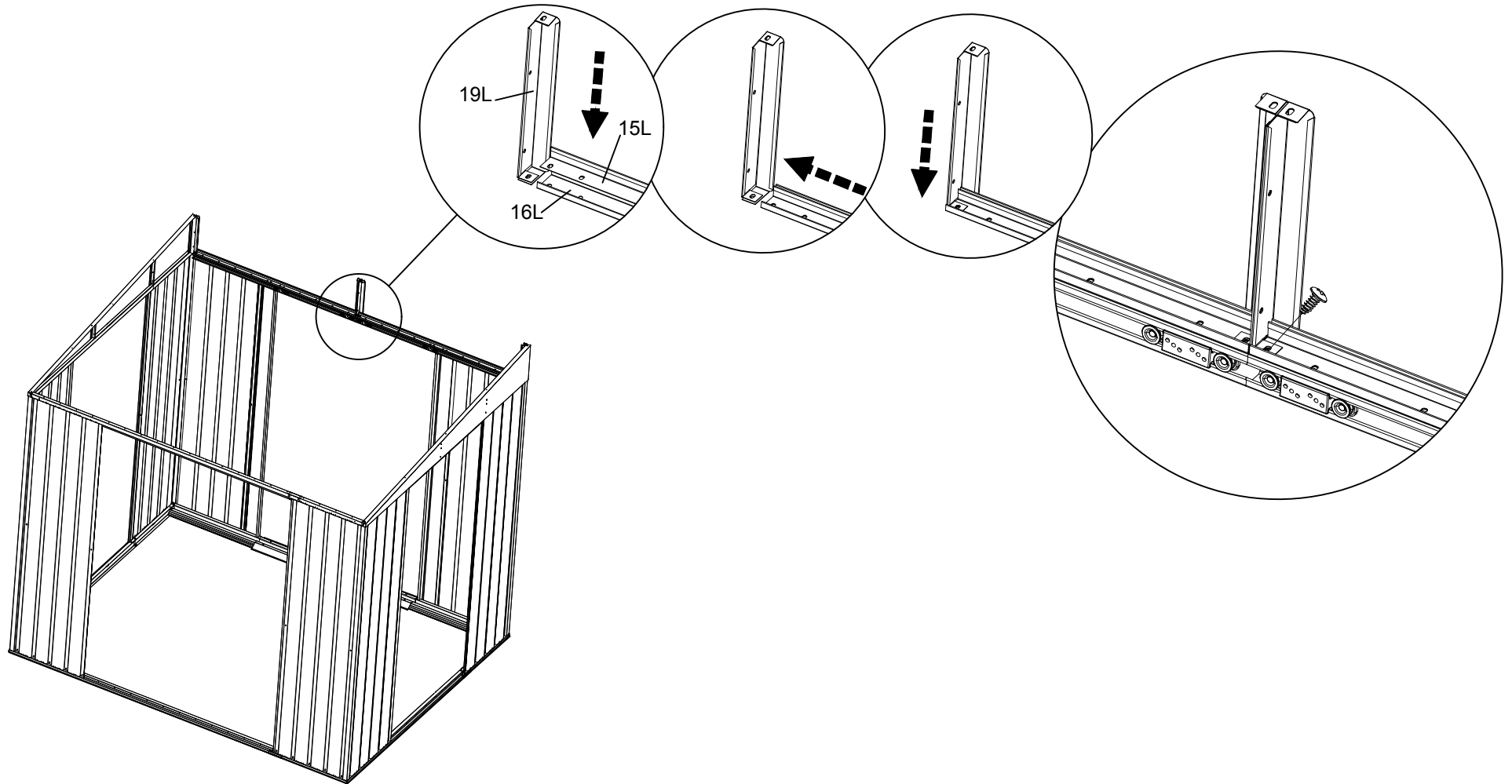

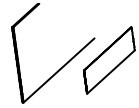

P5 x 2

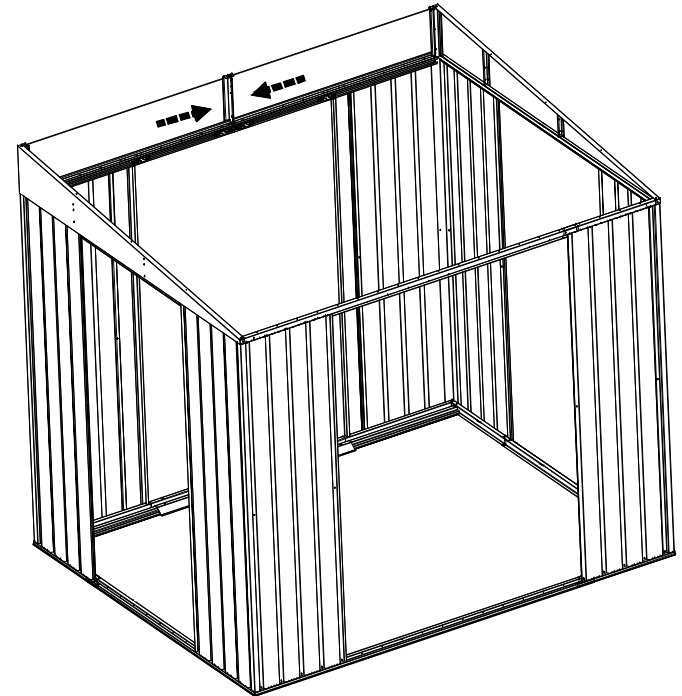
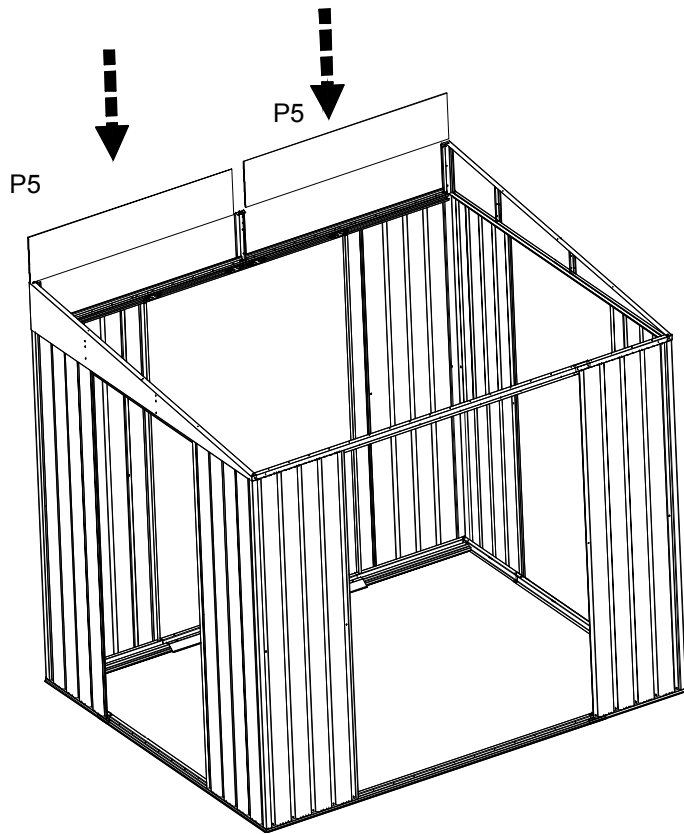

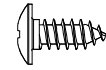

F1 x 20

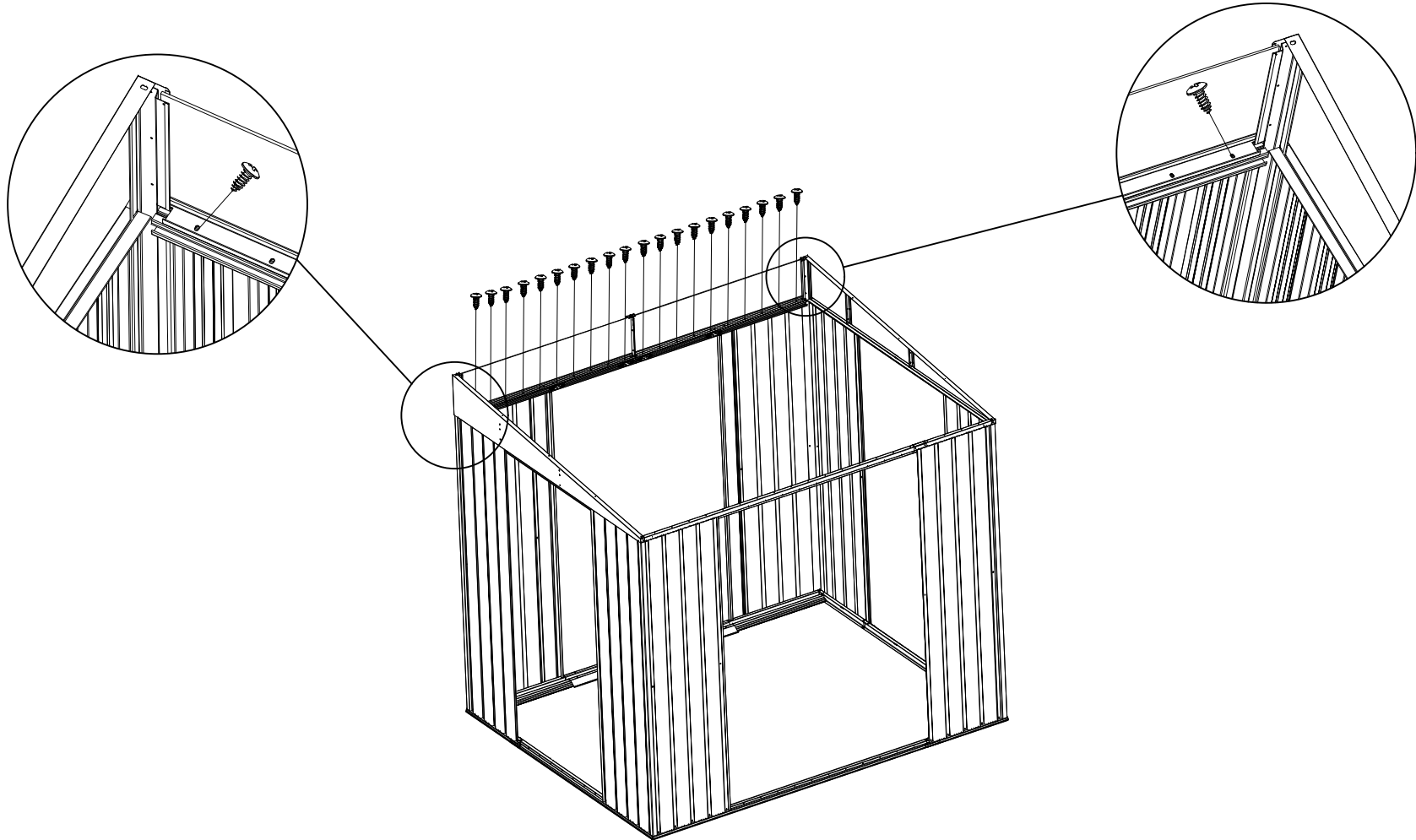

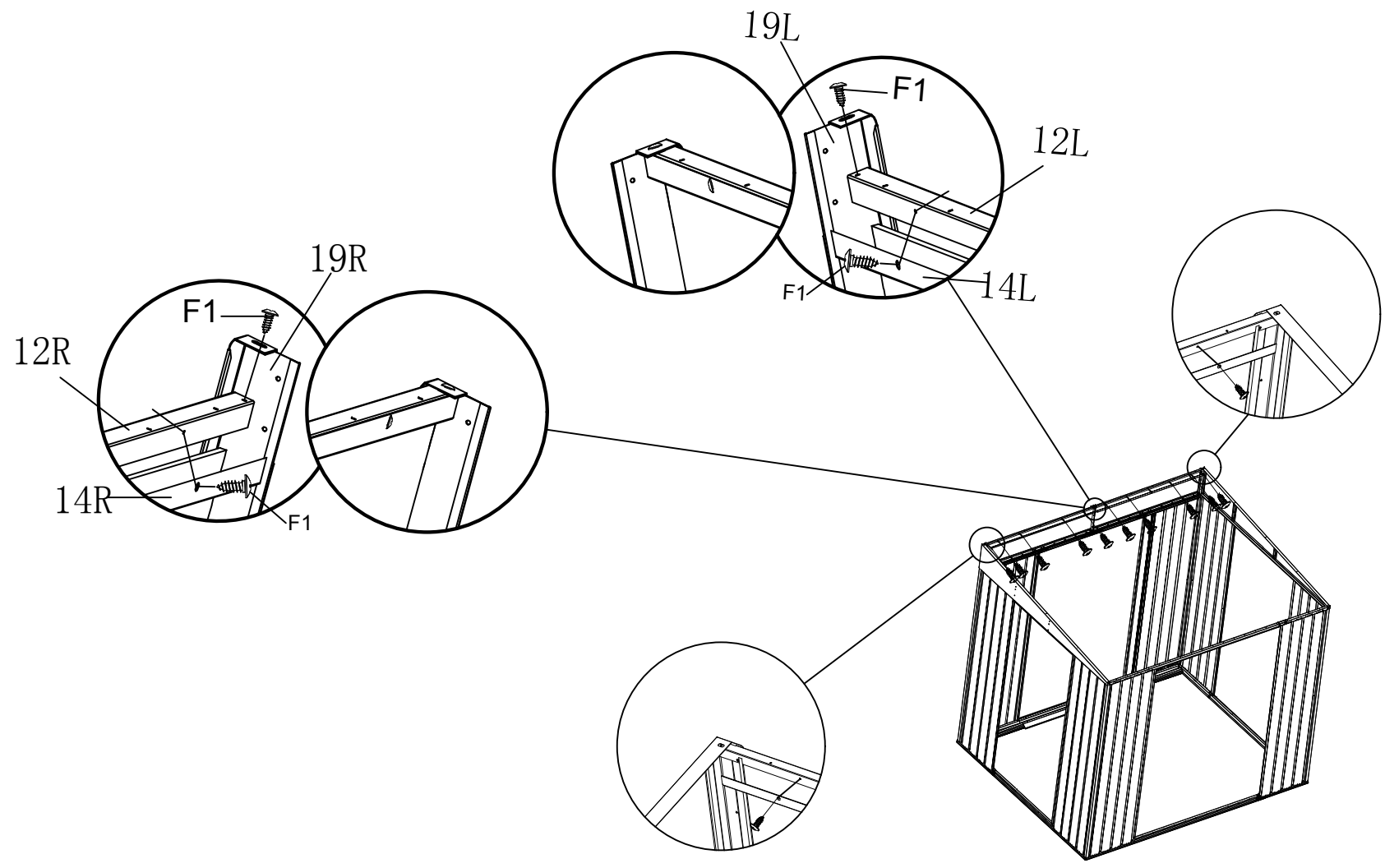
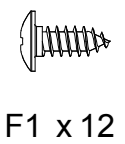
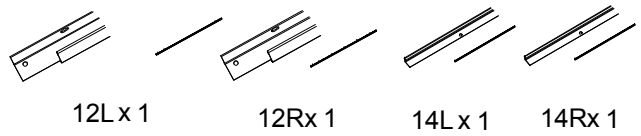

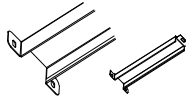

22 x 2

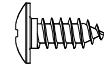

F1 x 6

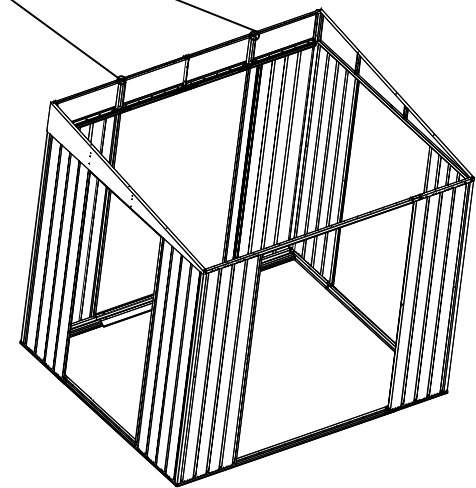
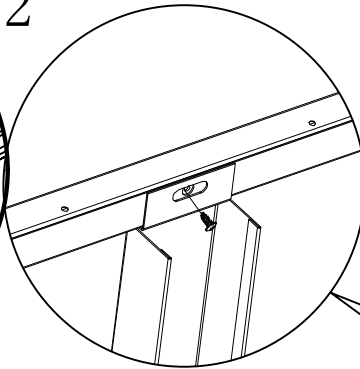
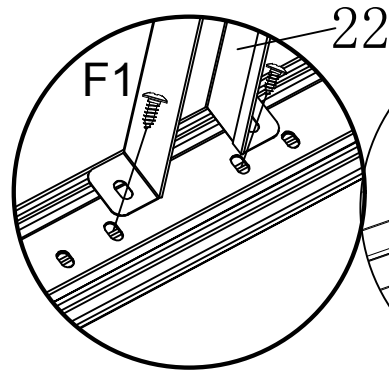

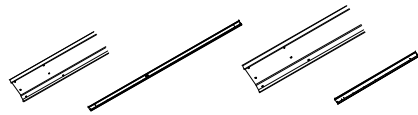

11 x 2

11-1 x 2

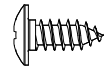

F1 x 16



S3 x 6

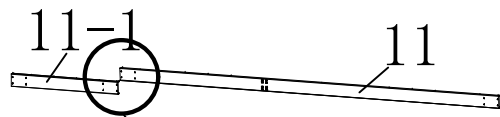
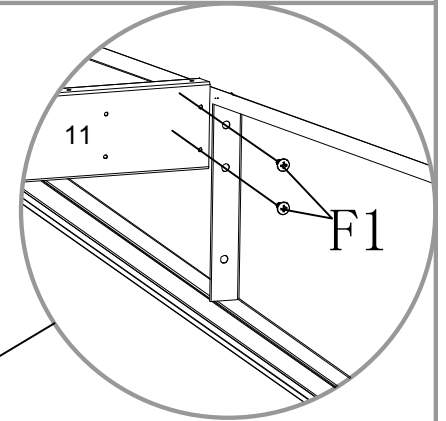
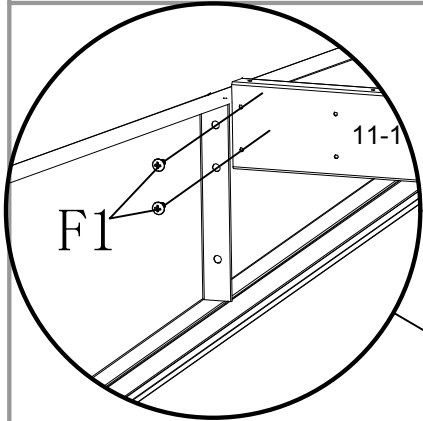

F1

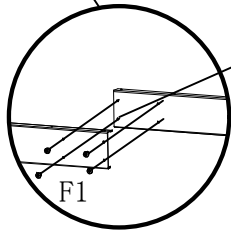
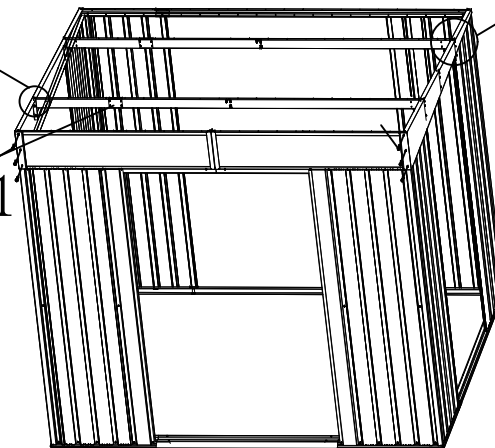

x2

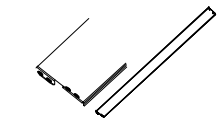

11-2 x 1

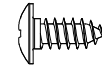

F1 x 2



F2 x 4

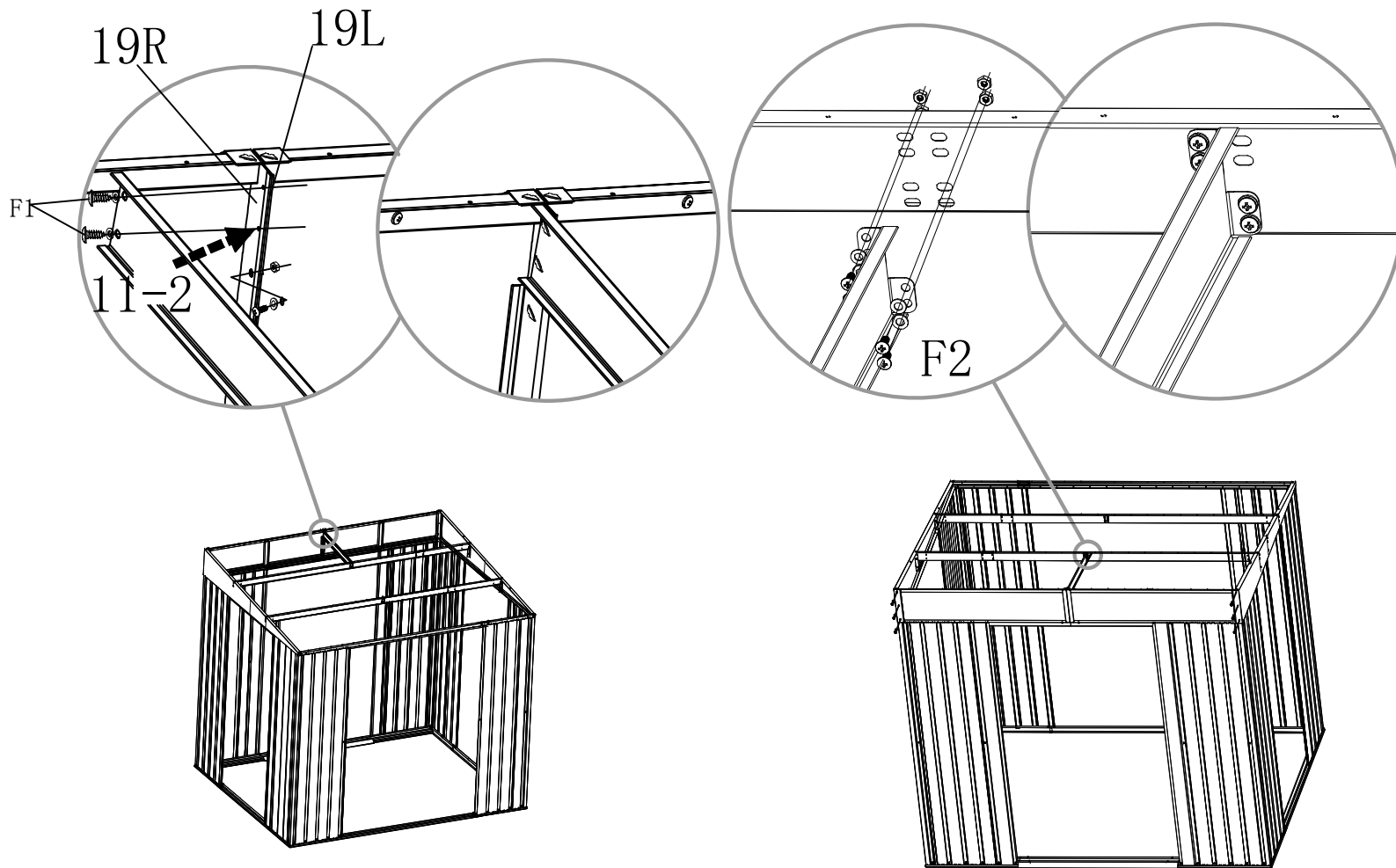

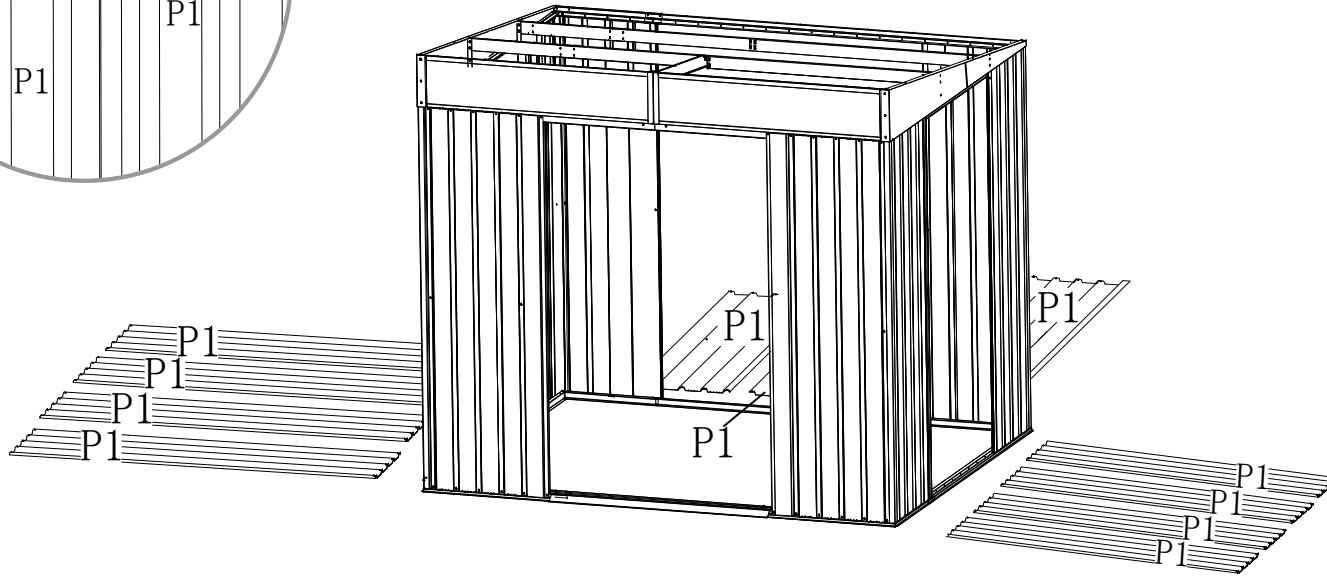
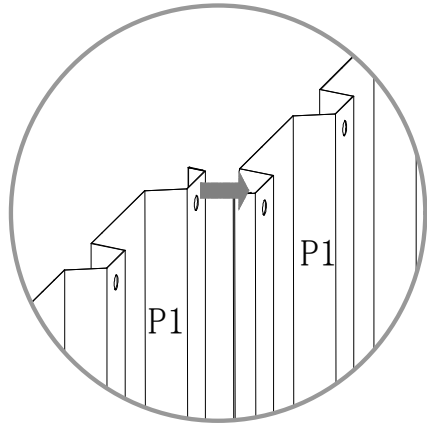
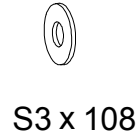
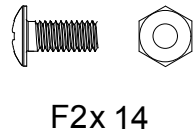
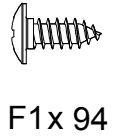
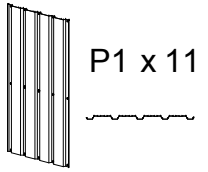

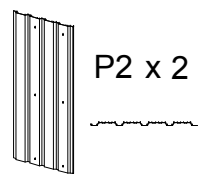

P2 x 2

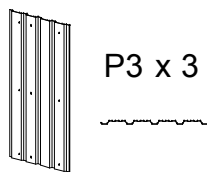

P3 x 3

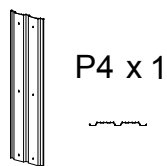

P4 x 1

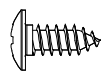

F1 x 32



S3 x 32

I

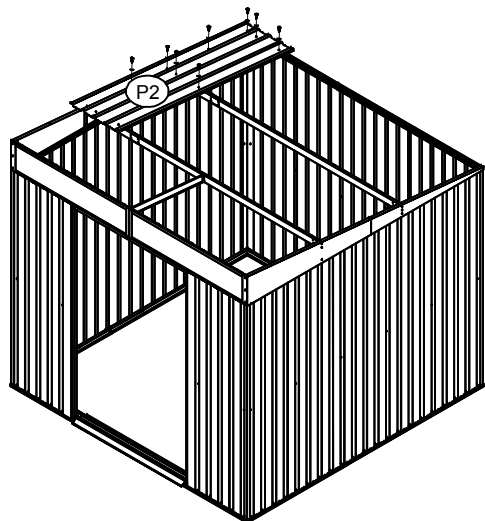

II

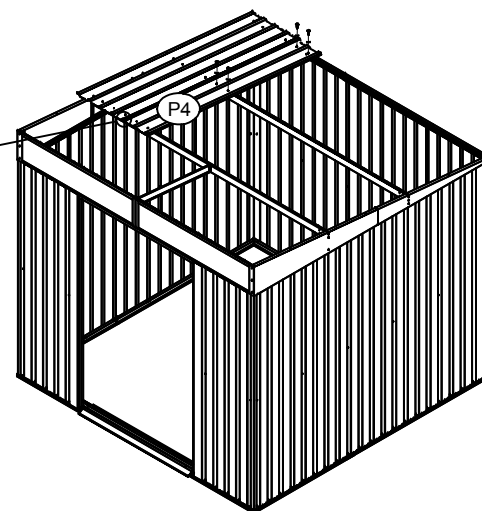
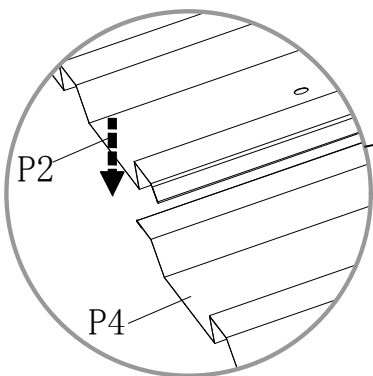

III

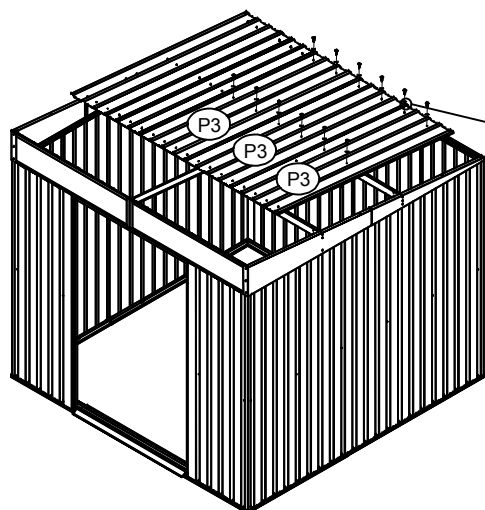

IV

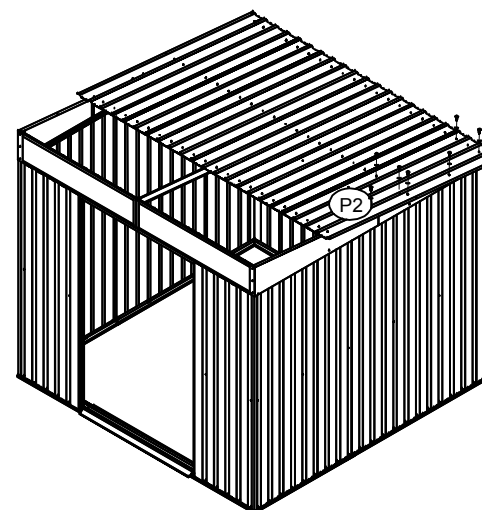
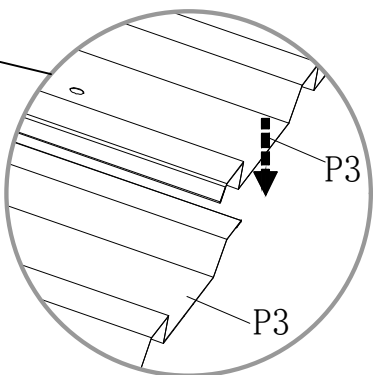

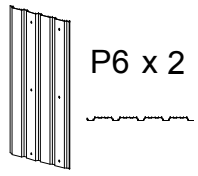

P6 x 2

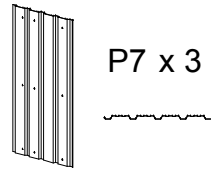

P7 x 3

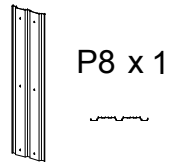

P8 x 1

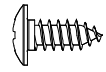

F1 x 30



S3 x 30

I

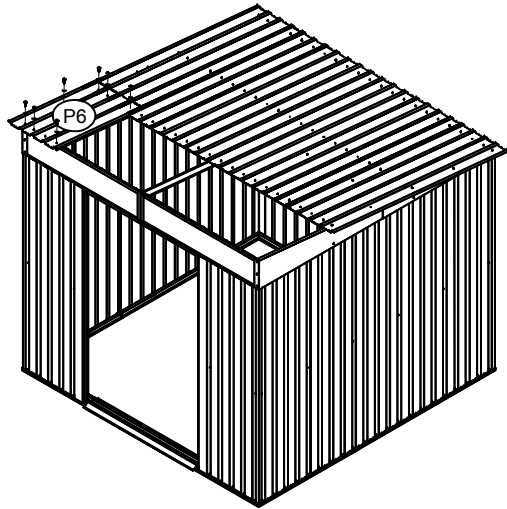

II

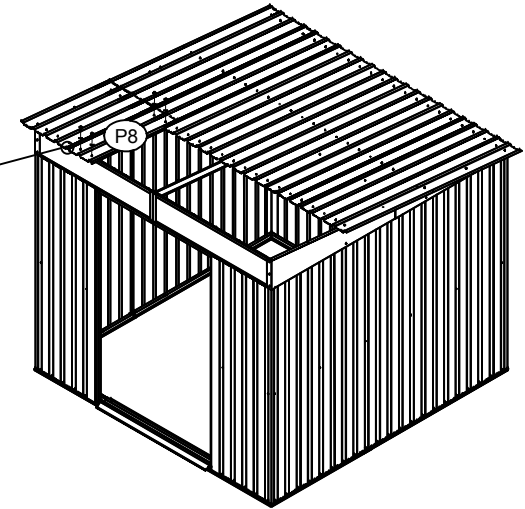
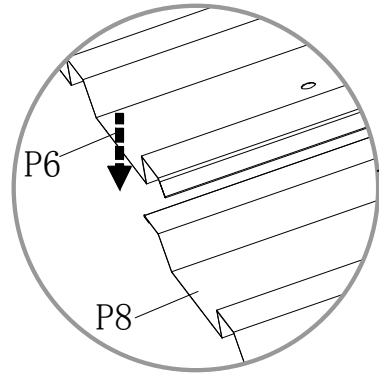

III

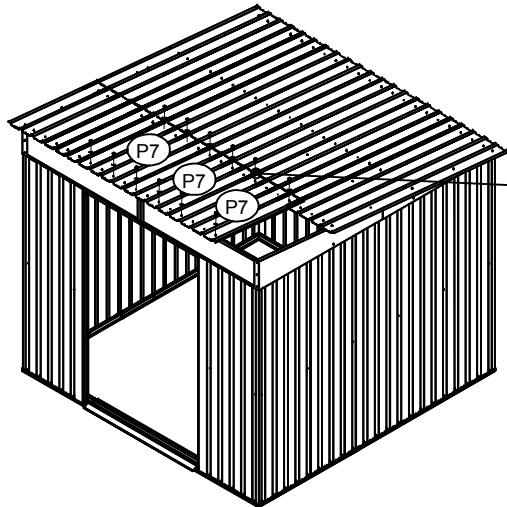

IV

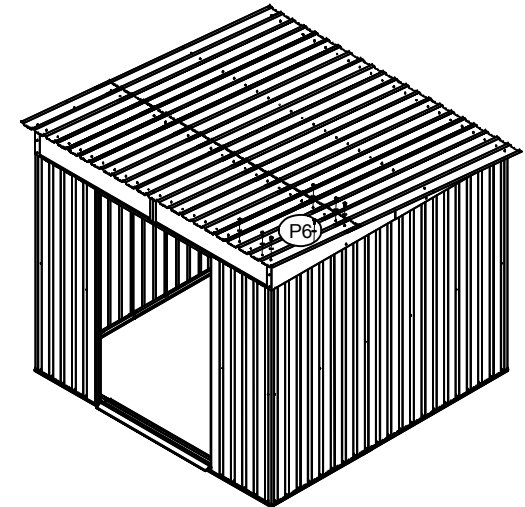
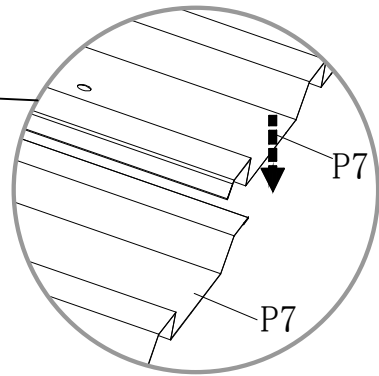

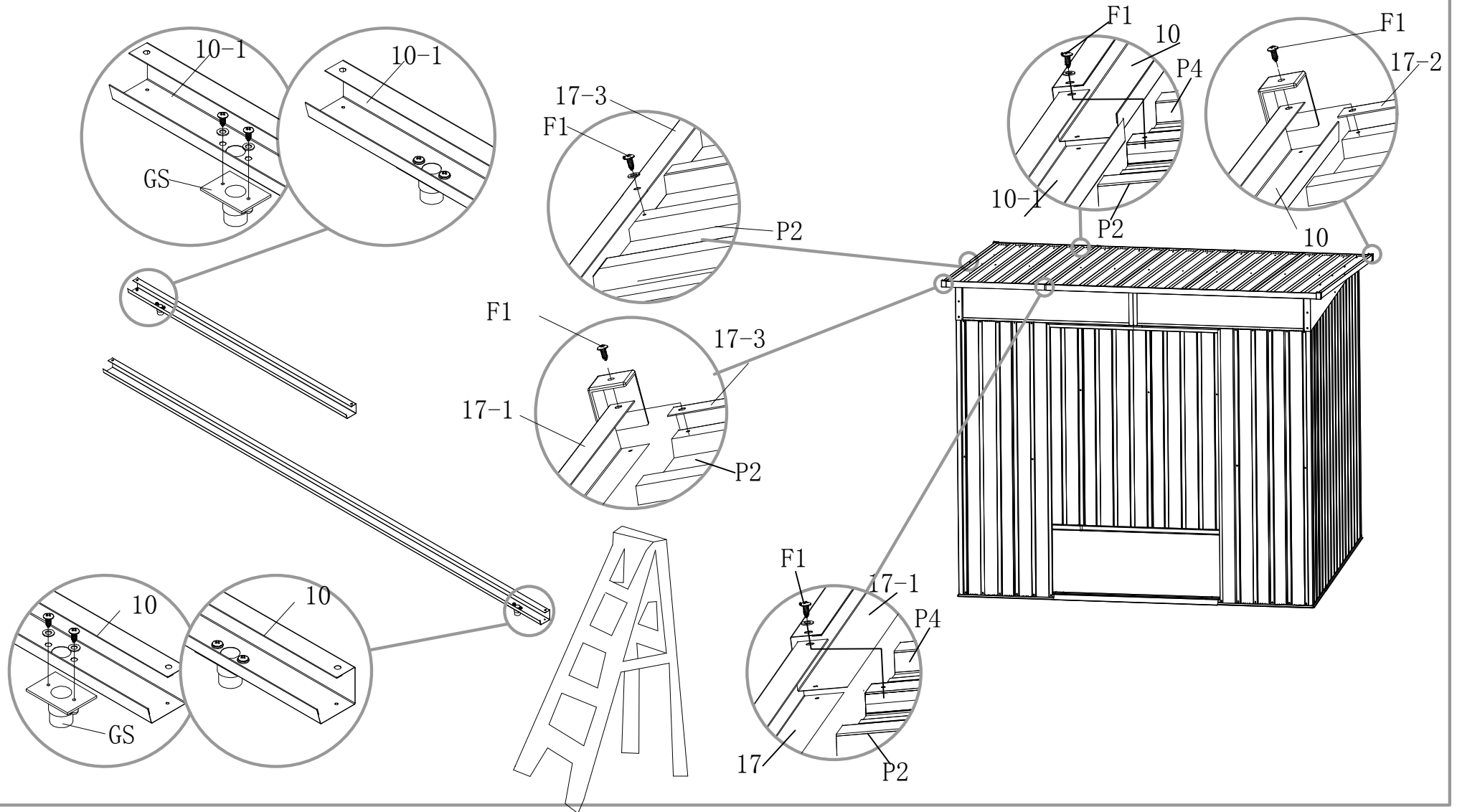
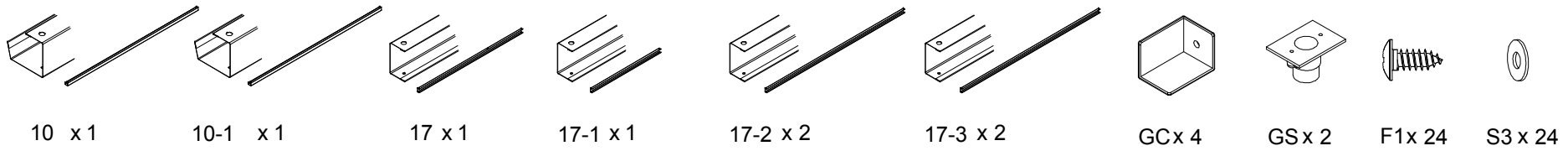

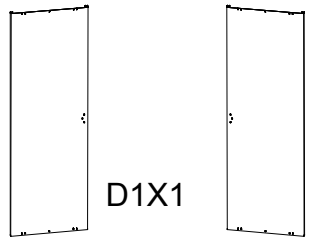

D1X1

D2X1

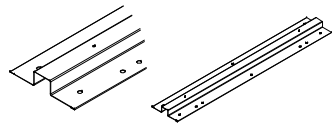

18 x 6

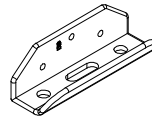

GB x 2

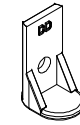

GD x 4

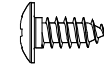

F1 x 12



F2 x 22

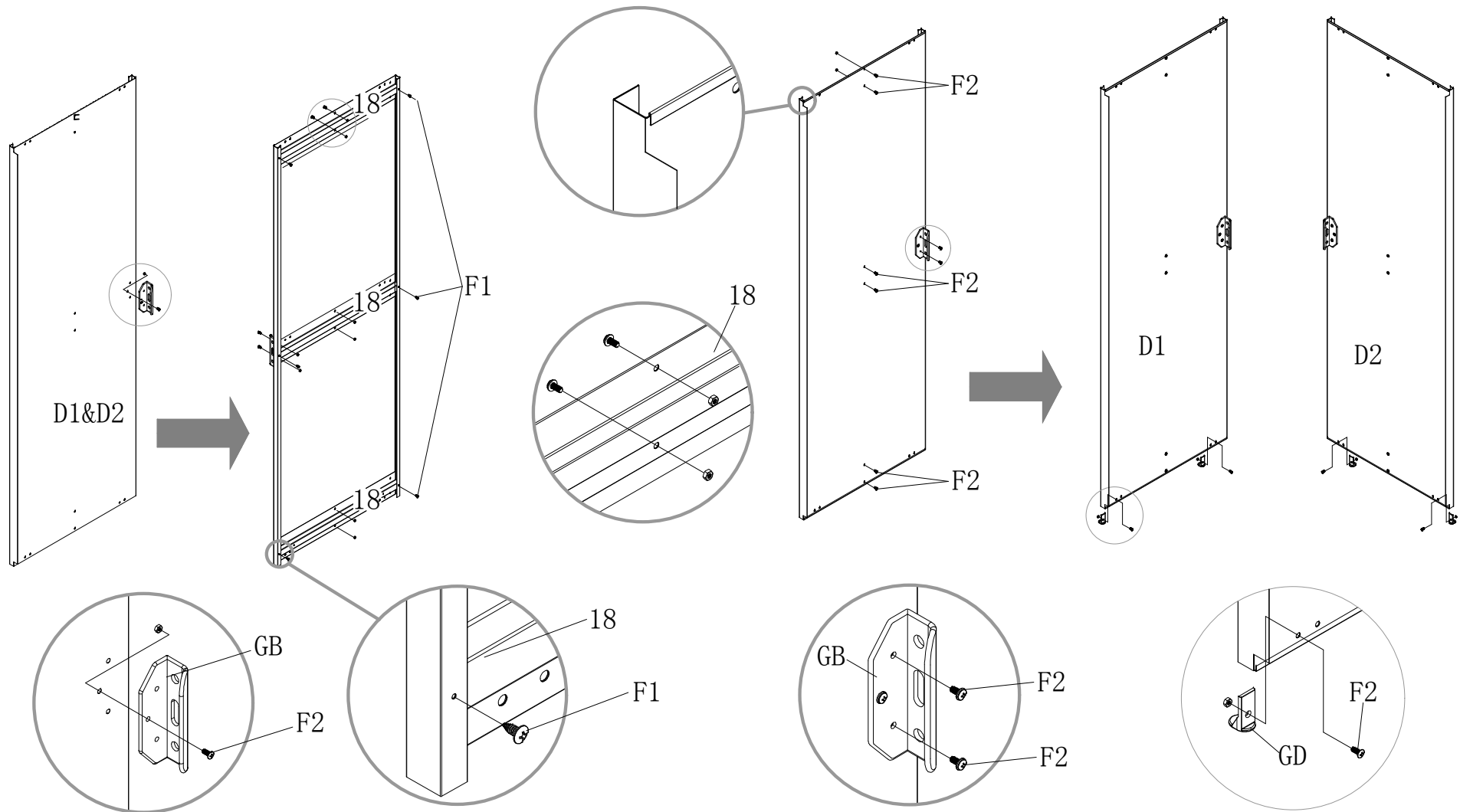

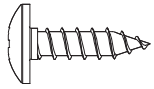

F3x 8

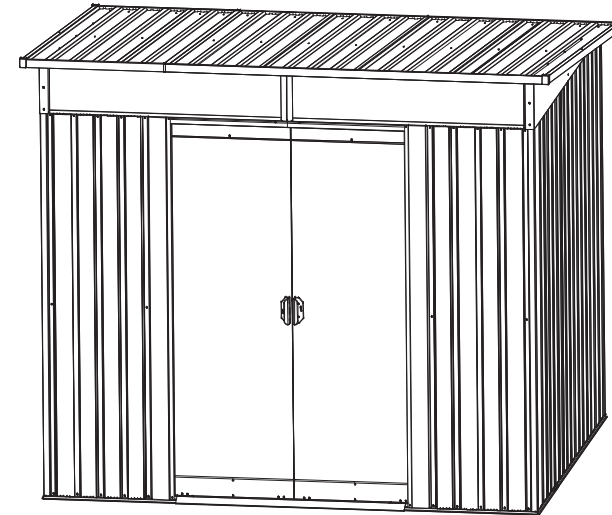
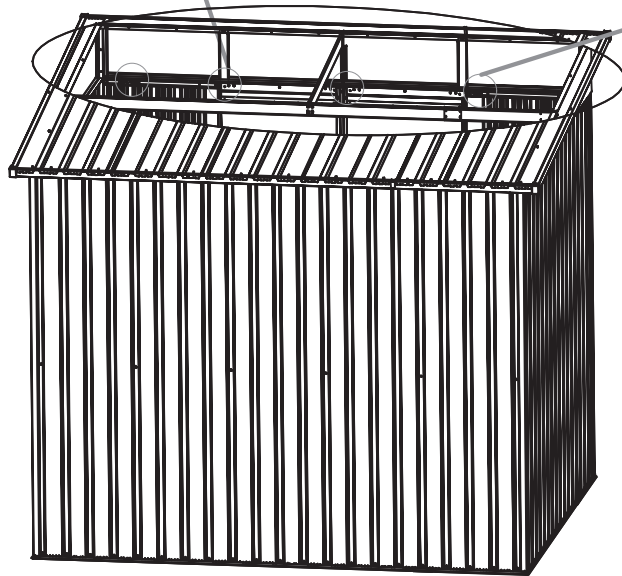
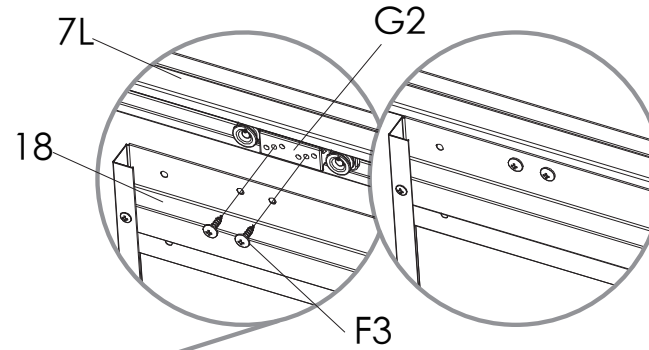
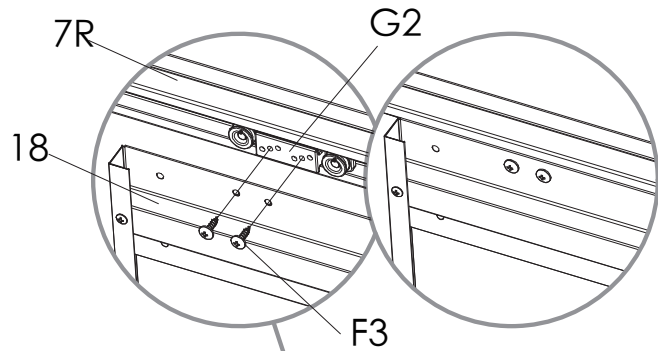

WARRANTY INFORMATION:

Please refer to our website for detailed warranty conditions and coverage.
For the most up-to-date and comprehensive warranty information, visit www.tmgindustrial.com