

# 12' X 40' TUNNEL GREENHOUSE GROW TENT

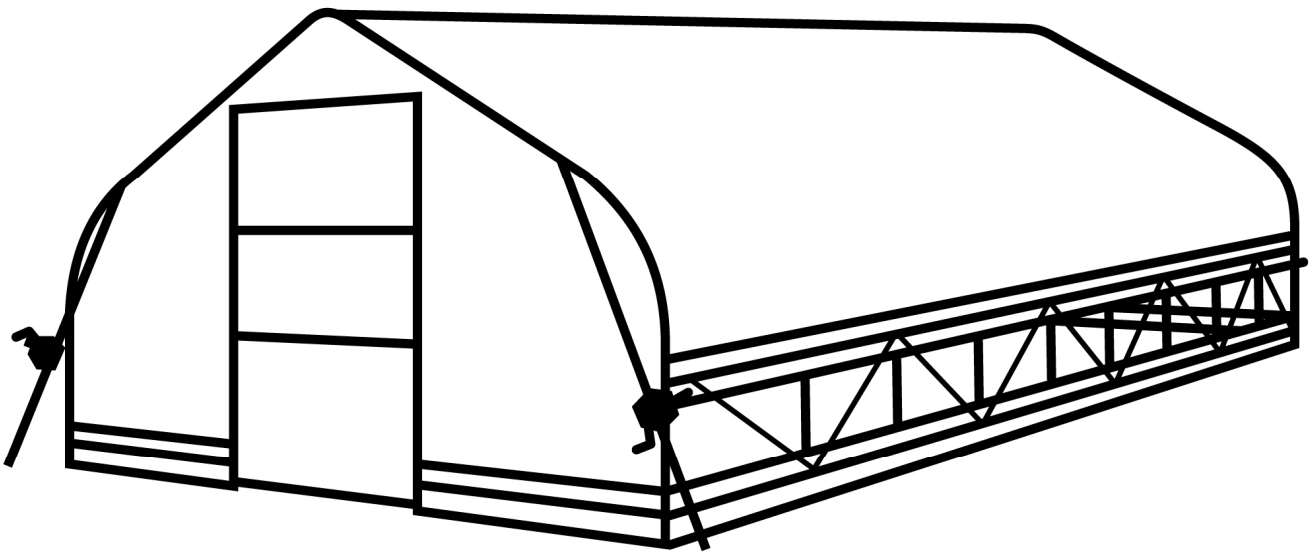

This structure is intended for temporary outdoor storage use only. It is not designed to withstand heavy snow and wind loads and does not come with engineering drawings. To ensure suitable for your specific weather needs, it is your responsibility to verify their appropriateness for your intended use and local weather conditions, especially in areas prone to severe weather.

- Please read and understand the product manual completely before assembly
- Check against the parts list to make sure all parts are received
- Wear proper safety goggles or other protective gears while in assembly
- Do not return the product to dealer. They are not equipped to handle your requests.

Missing parts or have questions on assembly?

Please call: 1-877-761-2819 or email: [cs@tmgindustrial.com](mailto:cs@tmgindustrial.com)

**MAIN SPECIFICATIONS :**

- Overall assembled size : W3.66 x L11.7 x H2.2 (m) / W12 x L38.4 x H7.2 (ft)
- Shoulder height : H1.2 m / 3.9 ft
- Door : W1.2 x H1.8 (m) / 3.9 x 5.9 (ft)

**CONCRETE FOUNDATION SIZE SEE BELOW FIGURE.**

- The layout of foundation (one).

Depth of cement

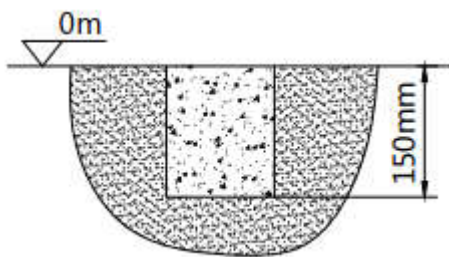

Unit: mm (ft)

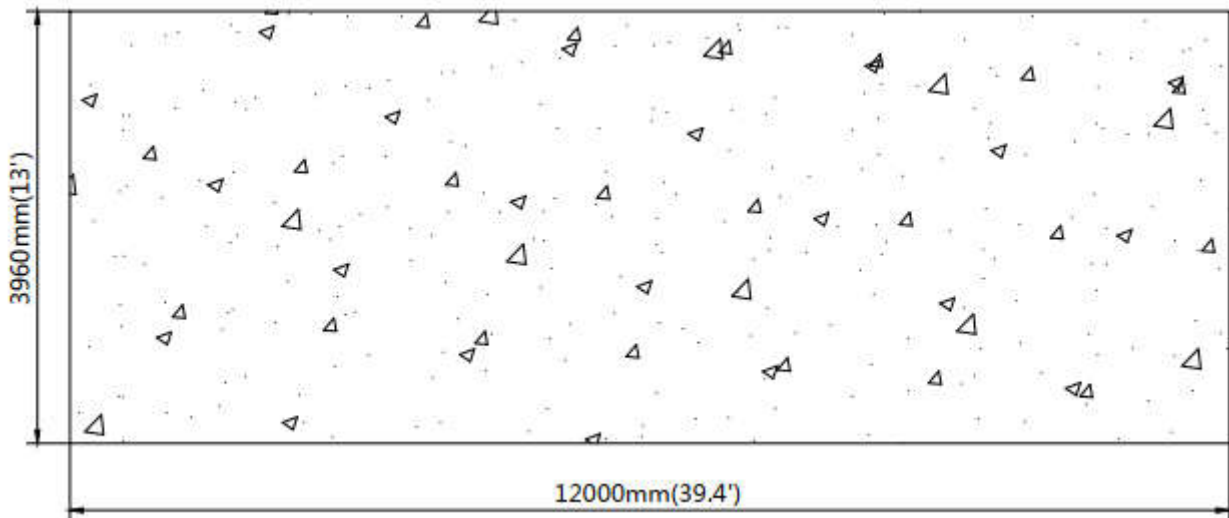

- The layout of foundation(two).

Note: the ground anchor is installed on the cement block.

Depth of cement

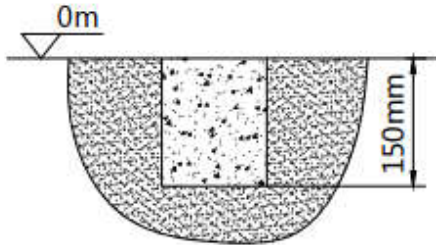

Unit: mm (ft)

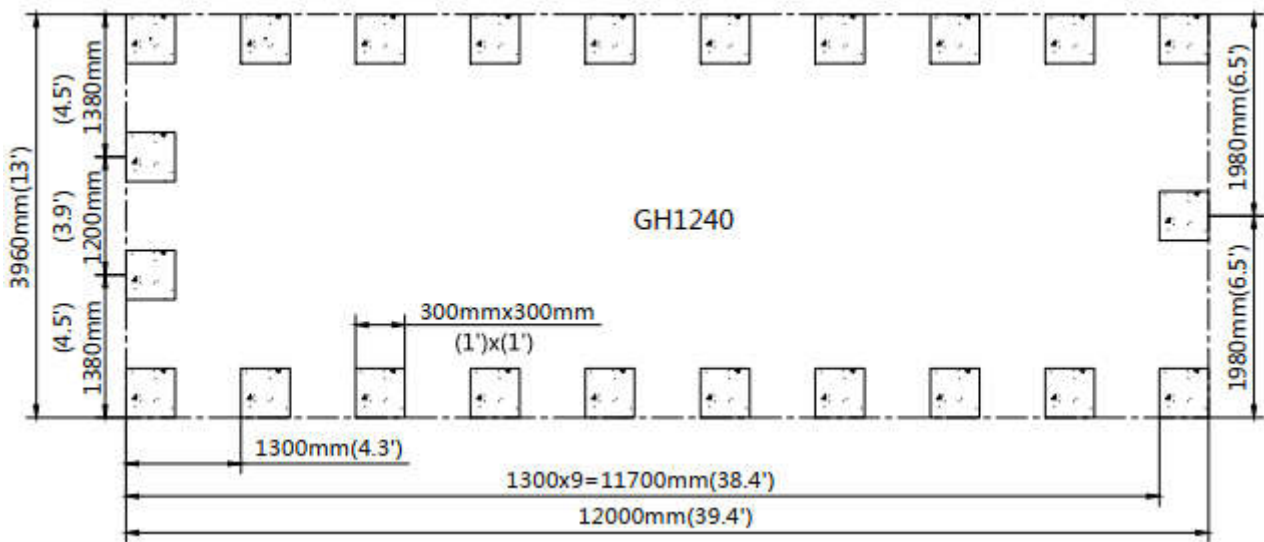

- Baseplate layout.

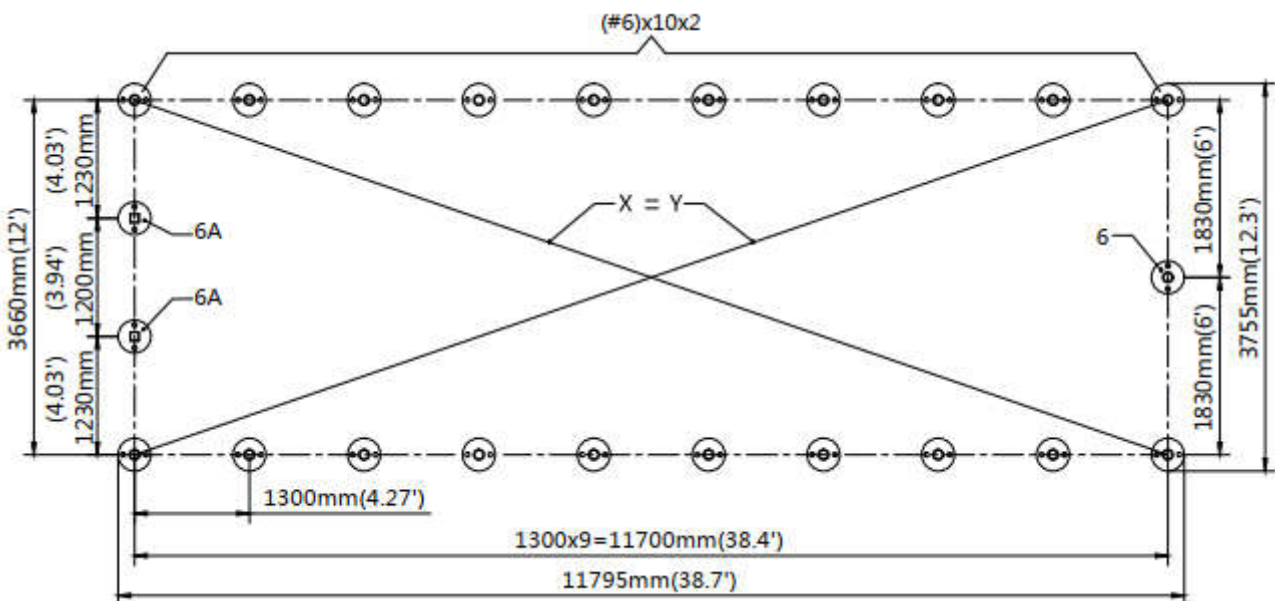

## **PRIOR TO ASSEMBLY**

Please read the instructions carefully before installation. It is important to follow your local safety regulations and industry standards during installation. Regulations may include but are not limited to :

- Safety helmets, protective eyewear, and clothing
- Safety harnesses for all elevated workers
- Proper ladder, cage, and safety operation











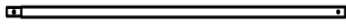



Check all components and parts before installation. All parts are marked with a part number, please refer to the parts list to make sure you have all parts.

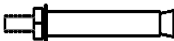













Choose a day with low or no wind to install, assembly is hard in heavy wind. Do not make any alterations to the structure. Do not hang any weights on the frame during installation, including parts. We are not responsible for any damages or injuries caused by inappropriate installation, unauthorized modifications or extreme weather.

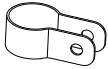









This building is not intended for human occupancy.

It is recommended to tape or add foam/rubber on the frame where joints connect and where it touches the cover. This will help extend the life span of the cover.

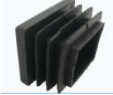
**TMG-GH1240 PART LIST**

<b>PARTS CODE</b>	<b>GRAPHICAL</b>	<b>DESCRIPTION</b>	<b>LENGTH</b>	<b>QTY</b>
1		Peak arch tube	L542mm	10
2		Upper rafter tube	L1404mm	20
3		Shoulder tube	L865mm	20
4		Sidewall tube	L668mm	20
5		Roof purlin (horizontal tube)	L1330mm	45
6		Base plate	L163mm	21
6A		Door column base plate	L83mm	2
6B		Expansion bolt	φ14x100mm	46
7		Front door cross tubes	L1145mm	2
8		Rear door cross tubes	L1745mm	2
9		Upper vertical tubes for rear truss	L1168mm	1
10		Lower vertical tubes for rear truss	L964mm	1
11		Door frame cross pull tube (front truss)	L1170mm	1
12		Door frame left tube (front truss)	L1820mm	1
13		Door frame right tube (front truss)	L1820mm	1

14		Door frame column left tube	L1760mm	1
15		Door frame column right tube	L1760mm	1
16		Door horizontal tube	L1090mm	4
17		Film rolling machine guide tube	L1490mm	2
18		Roll film tube	L1993mm	10
18A		Roll film tube	L2100mm	2
19		Tube clamp	φ32mm	6
20		Door buckle		1
21		Film rolling machine		2
22		Reed groove	L2m	44
22A		Clip spring	L2m	44
23		Eight clip spring	L120mm	20
24		Pressure film carrier	φ25mm	20
25		Half round head bolt	M6x50mm	60
26		Hex bolt	M6x45mm	92

27		Hex bolt	M6x80mm	2
28		Self tapping screw	#12x25mm	240
28A		Self tapping screw	#12x35mm	4
29		Self tapping screw	#12x35mm	94
30		Socket wrench	8mm	1
30A		Hex wrench	4mm	1
31		Square plug	30x30mm	6
32		Round plug	φ25mm	6
33		Braided rope	30m	1 bundle
34		Adhesive tape	10m	2
35		Top cover film	W7.5xL12.5m	1
35A		Front and rear film	W2.5xL5m	2
36		Board (not included)	150x15x2000mm	28

**INSTALLATION STEPS**

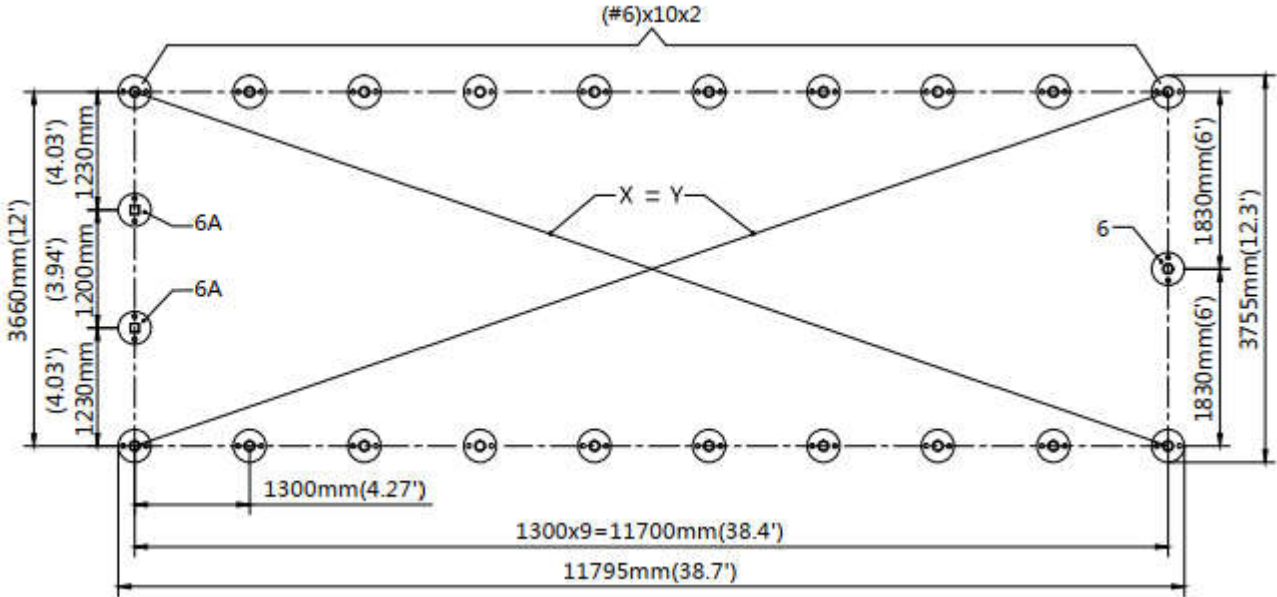

**STEP 1 : REVIEW THE WHOLE STRUCTURE AND CHOOSE THE PROPER INSTALLATION SITE.**

- Mark the ground in the final building location with a line showing the positions of base plates, front doors. All lines should be drawn from center to center of all base plate tubes. Diagonal line X must be equal to Y.

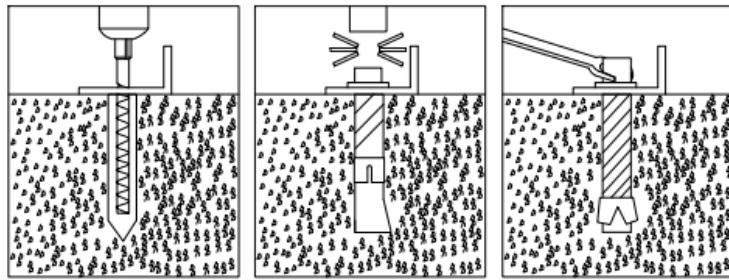

- Installation diagram of expansion bolt.



NO.	PART	QTY
6		21
6A		2

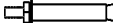

NO.	PART	QTY
6B		46



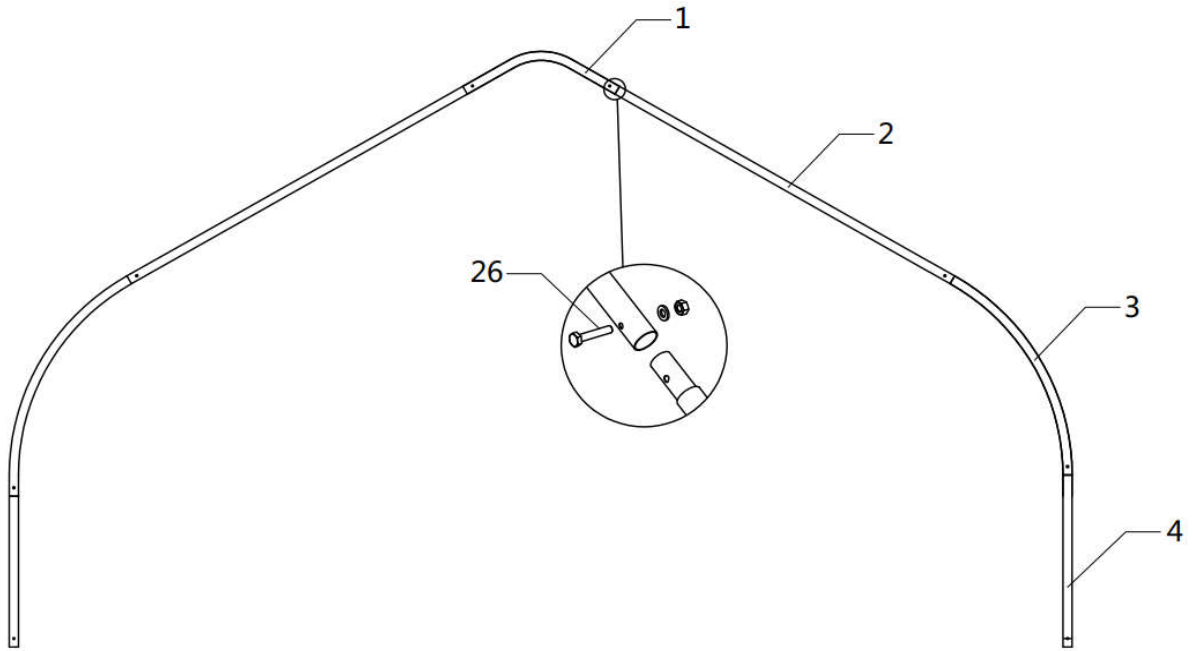

**STEP 2 : ASSEMBLE ALL TRUSSES.**

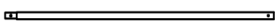
- The building includes 10 trusses , Connect all pipes with hex bolt (#26).



NO.	PART	QTY
1		1x10
2		2x10
3		2x10

NO.	PART	QTY
4		2x10
26		6x10

- Lay down all (10) trusses on the ground when the assembly is all completed and before moving to next step, and then wrap (#34) around the sharp points of the joint to avoid friction between the fabric and the interface, resulting in fabric damage.

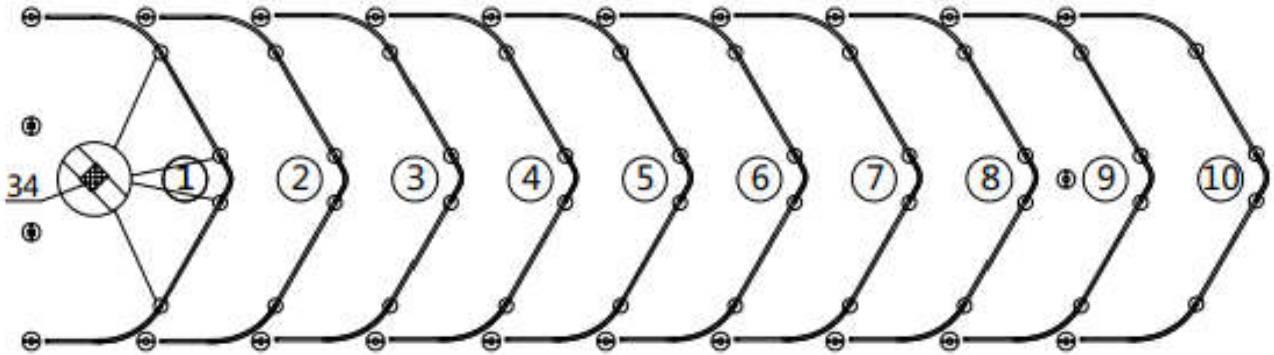

NO.	PART	QTY
34		1



**STEP 3 : PUT UP ALL TRUSSES.**

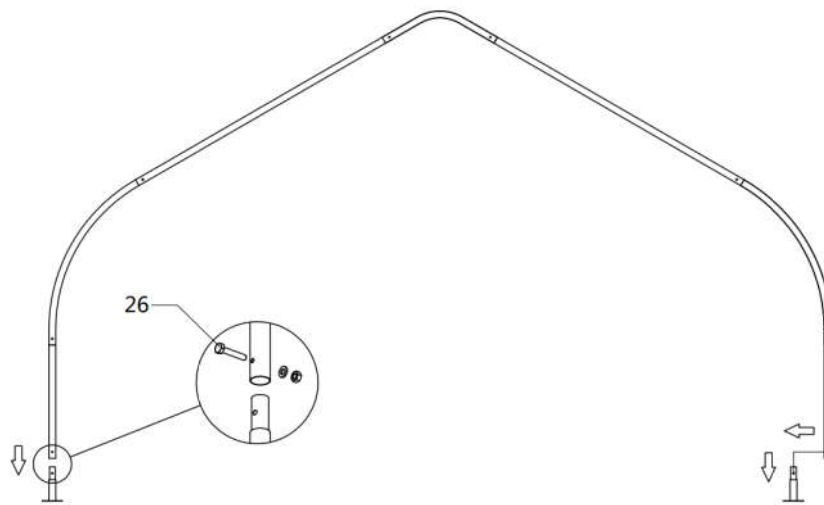

- Put up the truss, use hex bolt (#26) to secure the truss to the base plates.

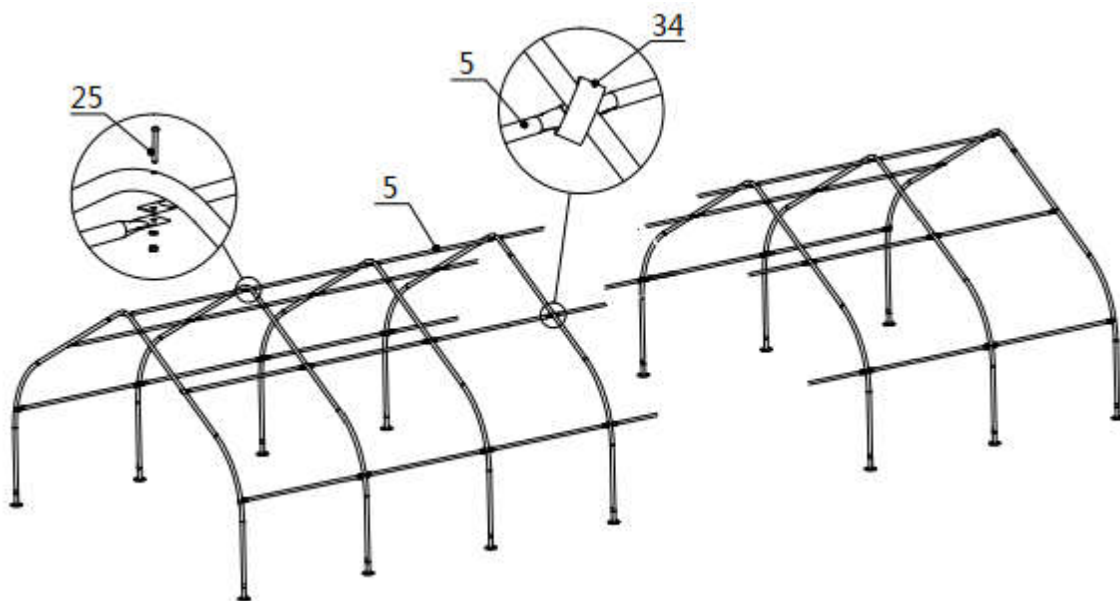

- Connect all purlins, and then wrap (#34) around the sharp points.



NO.	PART	QTY
5		45
25		50

NO.	PART	QTY
26		20
34		1

**STEP 4 : INSTALLATION OF FRONT AND REAR TRUSSES.**

- Installation of the front truss.

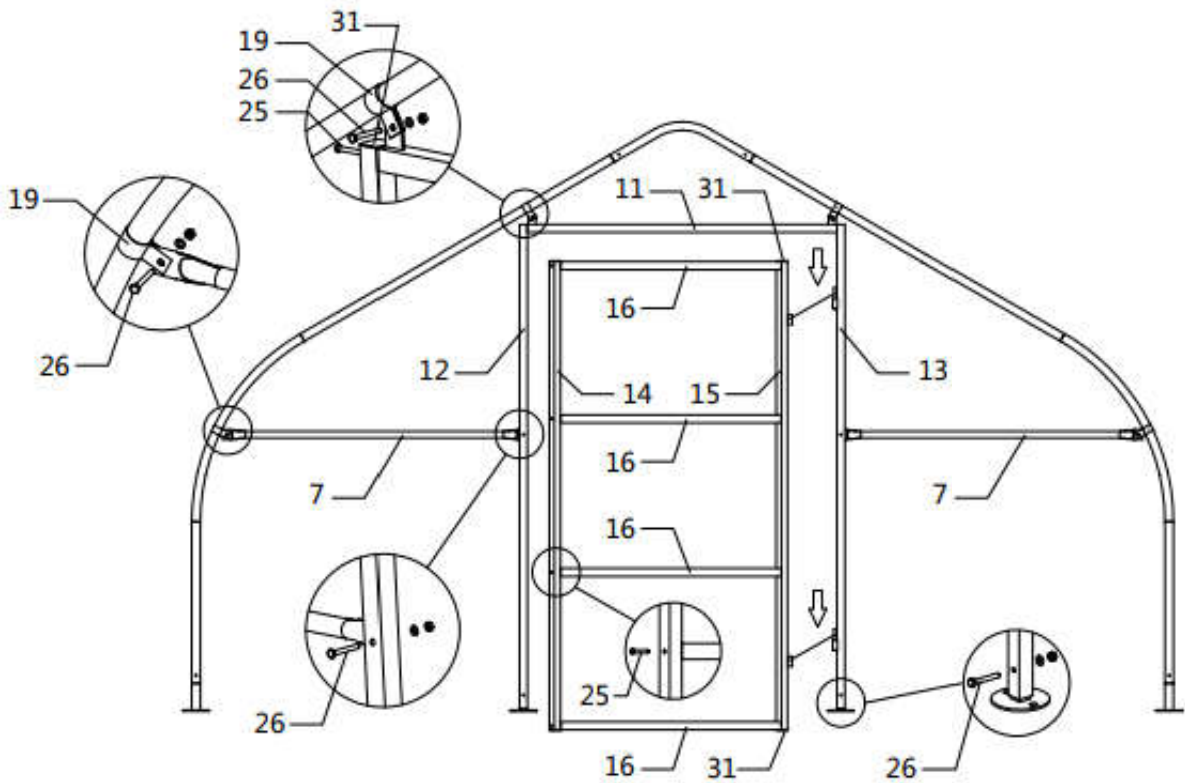



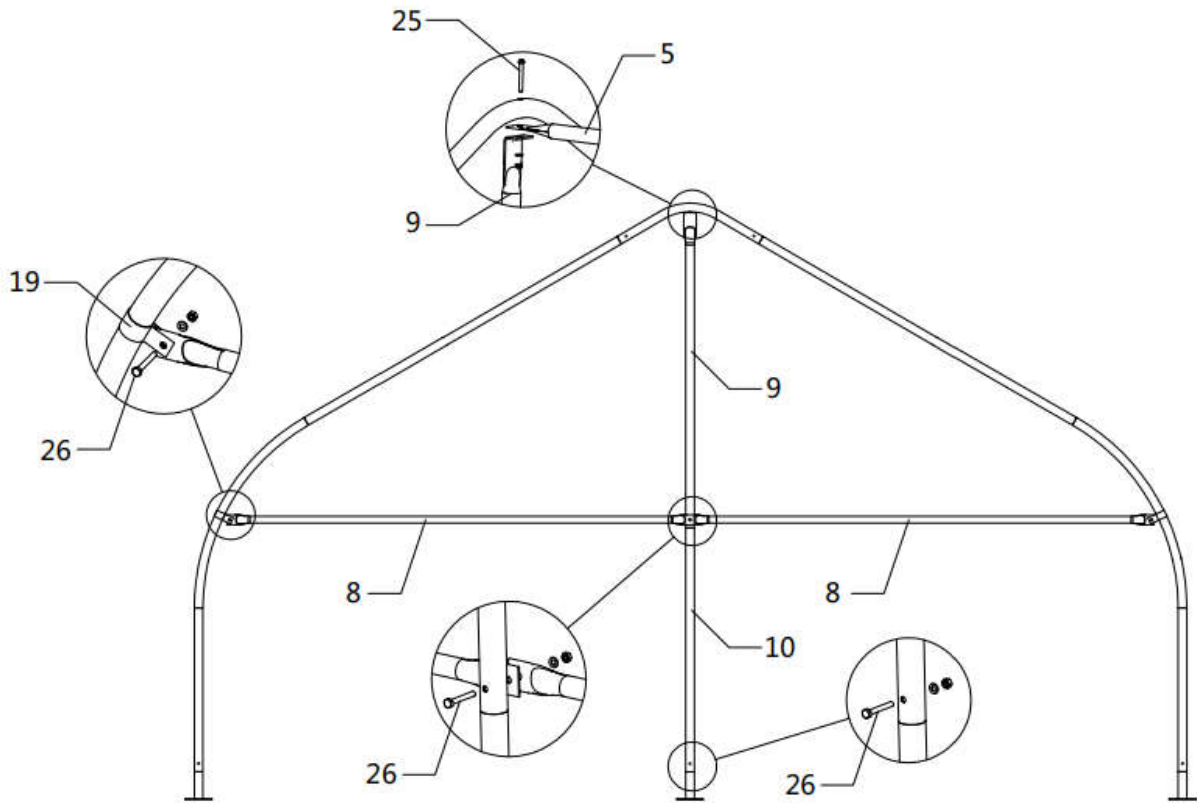

NO.	PART	QTY
7		2
11		1
12		1
13		1
14		1
15		1

NO.	PART	QTY
16		4
19		4
25		10
26		8
31		6

- Installation of the rear truss.

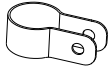

NO.	PART	QTY
8		2
9		1
10		1



NO.	PART	QTY
19		2
26		4

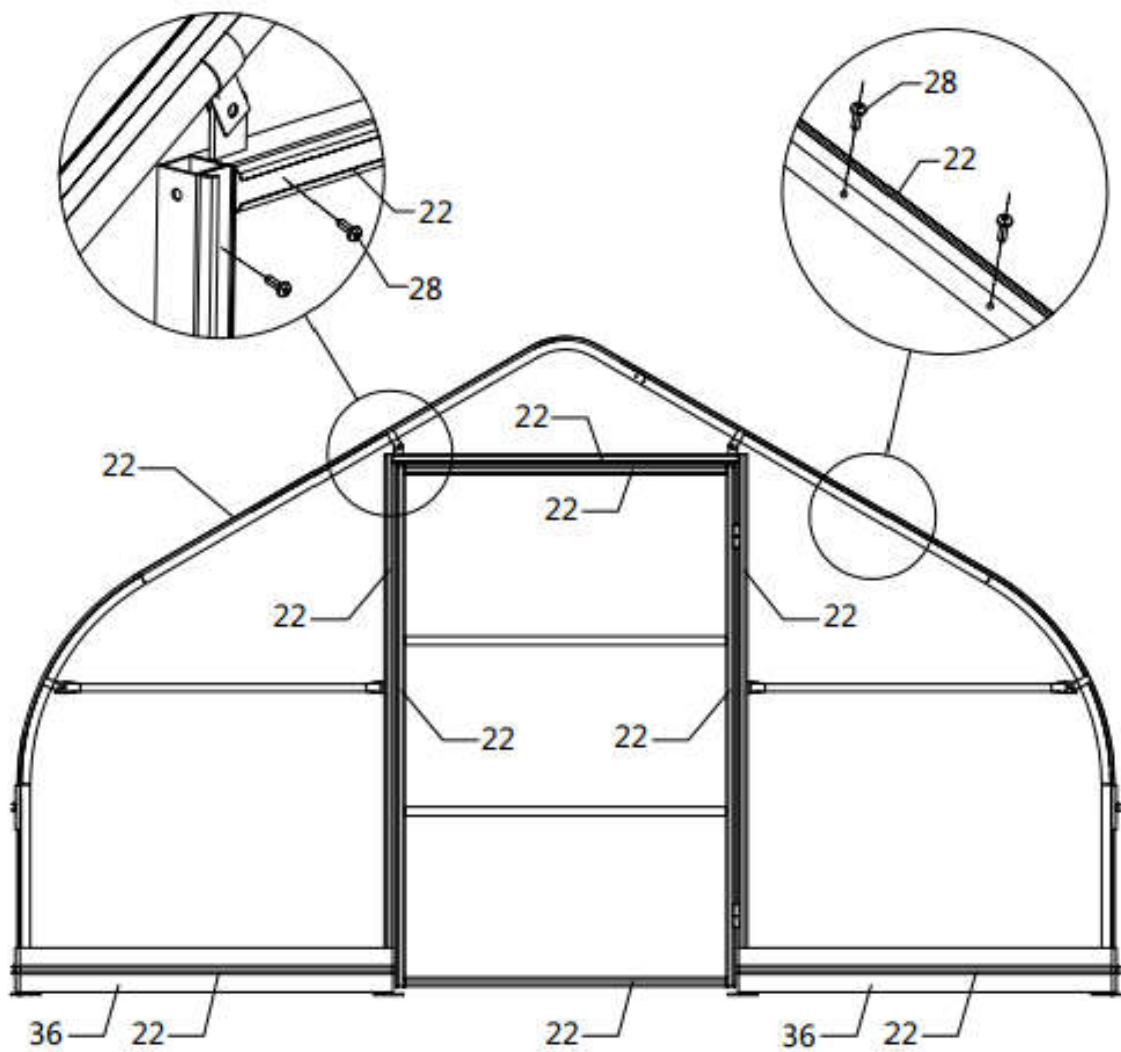

**STEP 5 : INSTALL BOARDS (#36) AND REED GROOVE (#22).**

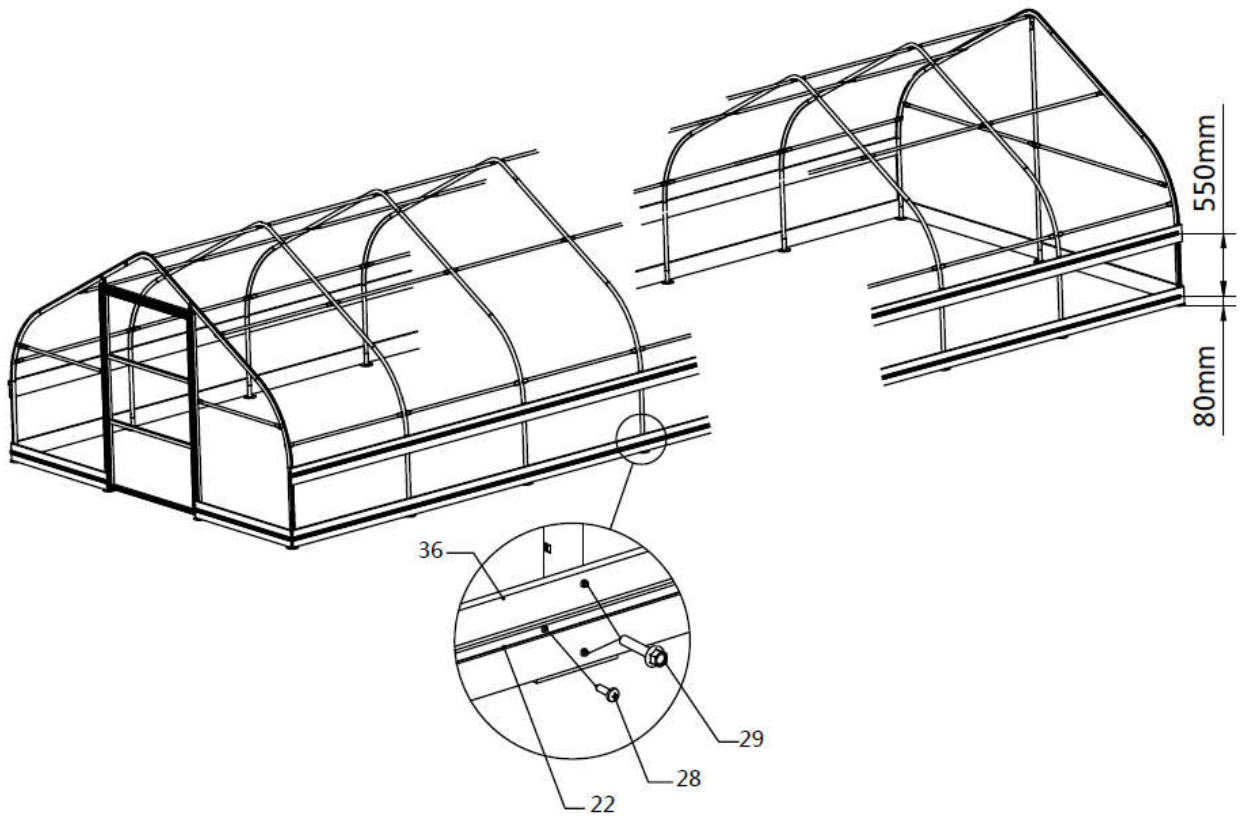
- Fix the board (# 36) with self tapping screw (# 29).
- Fix the reed groove (# 22) with the self tapping screw (# 28).







NO.	PART	QTY
22		44
28		220

NO.	PART	QTY
29		94
36		28

**STEP 6 : INSTALL THE FILM.**

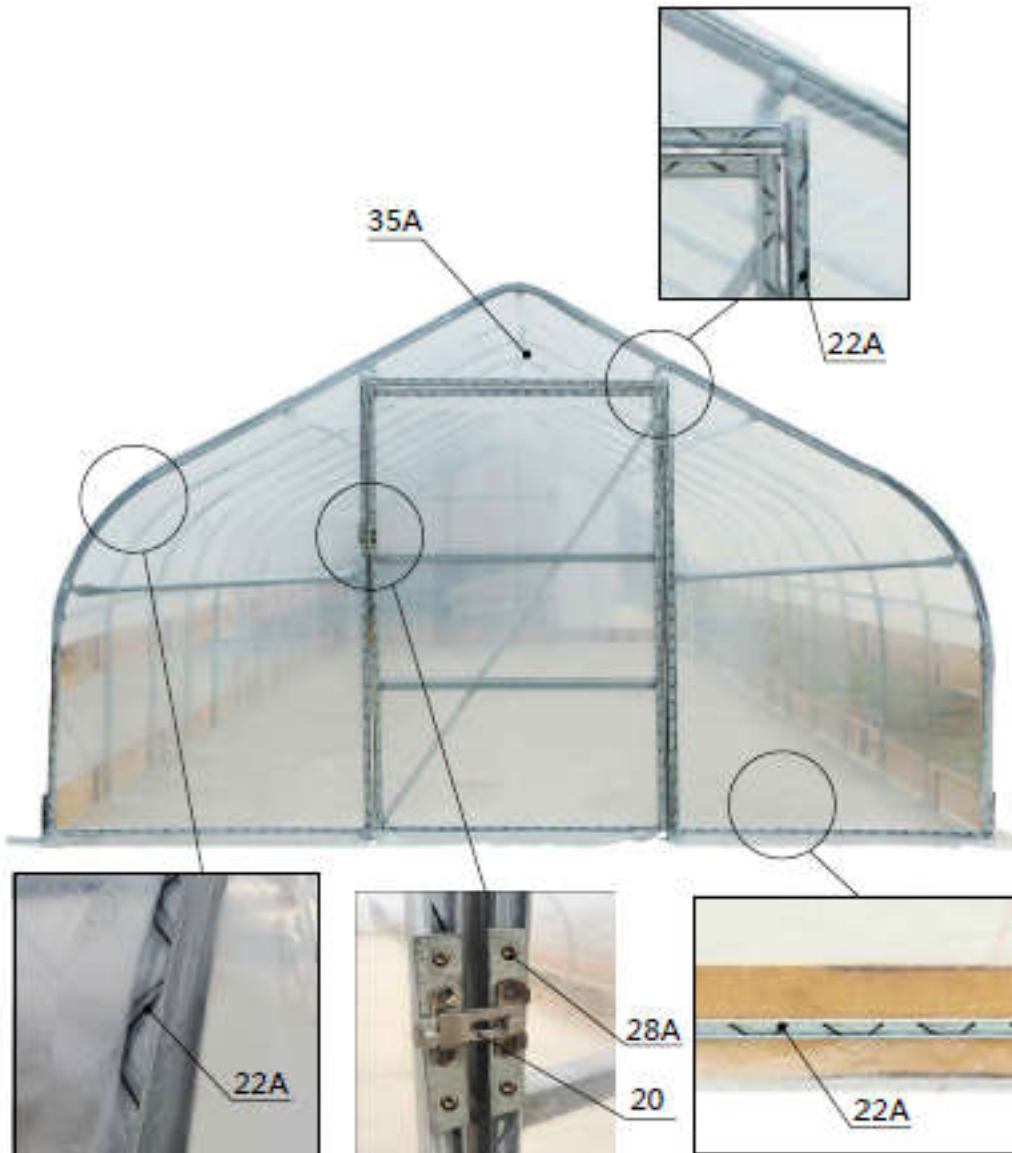
- Install the front film.





NO.	PART	QTY
20		1
22A		11

NO.	PART	QTY
28A		4
35A		1



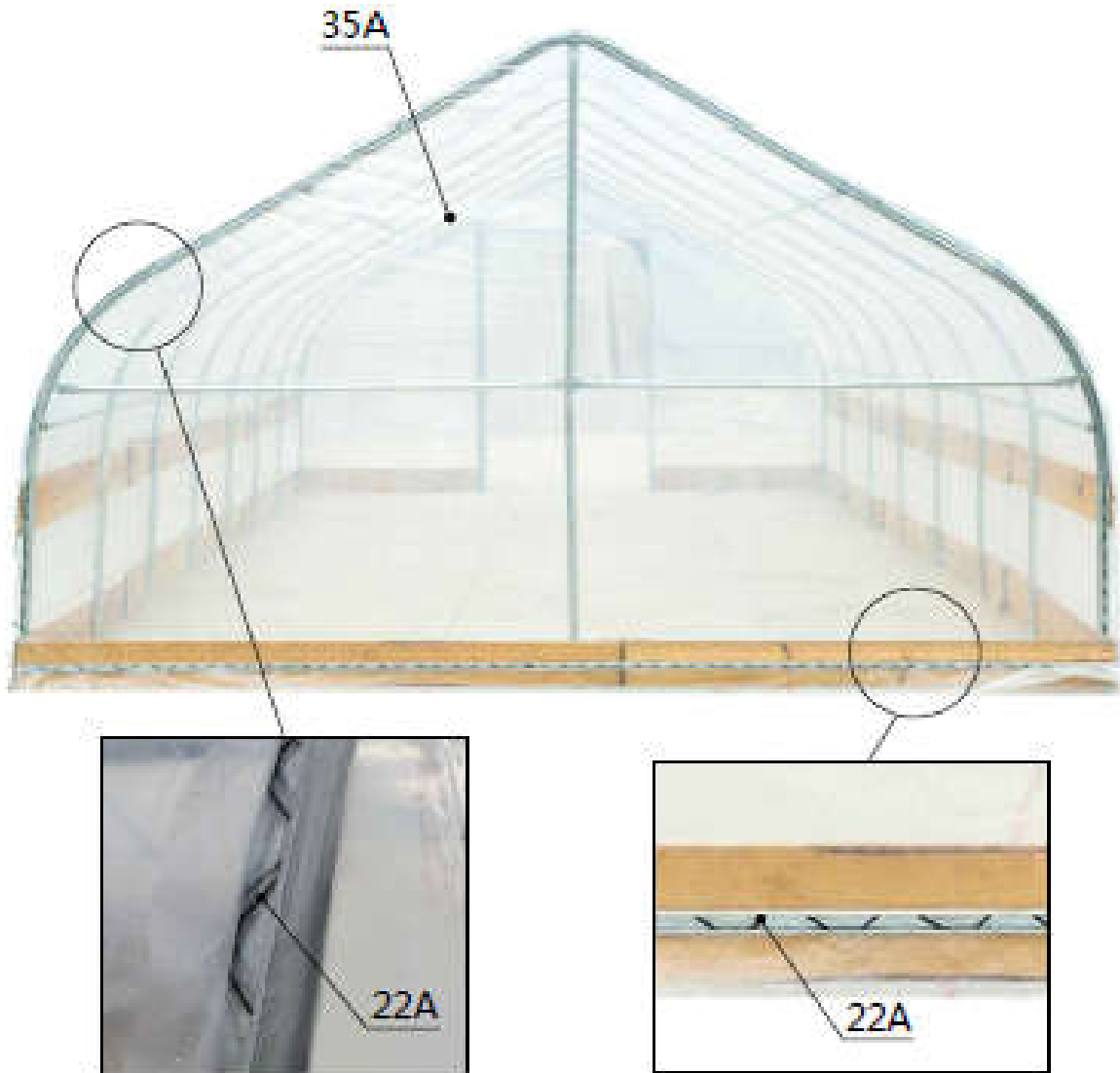

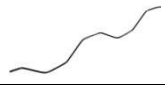
- Install the rear film.

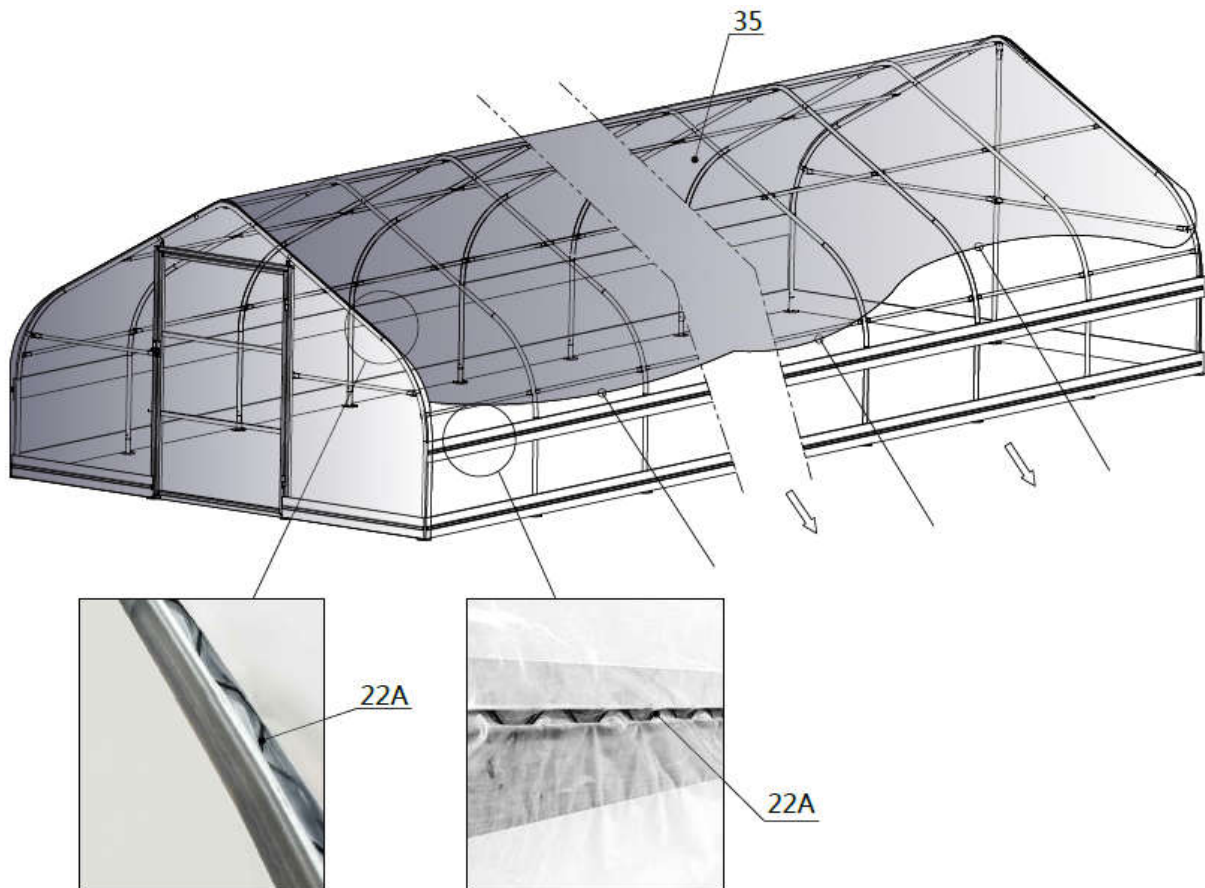

NO.	PART	QTY
22A		6
35A		1

- When you are ready to install the roof cover, unpack the cover and position it parallel to the building frame on one side. the cover must be pulled over the top of the truss frame without being snagged or stressed on any frame members. tighten the film evenly to eliminate wrinkles and make the film flat and smooth. Do not over-tighten during the adjustment process, otherwise it will cause unnecessary damage. At this time, you can install a clip spring (#22A) to fix the film.



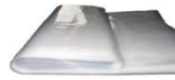

NO.	PART	QTY
22A		27
35		1

**STEP 7 : INSTALL ROLL FILM SYSTEM.**

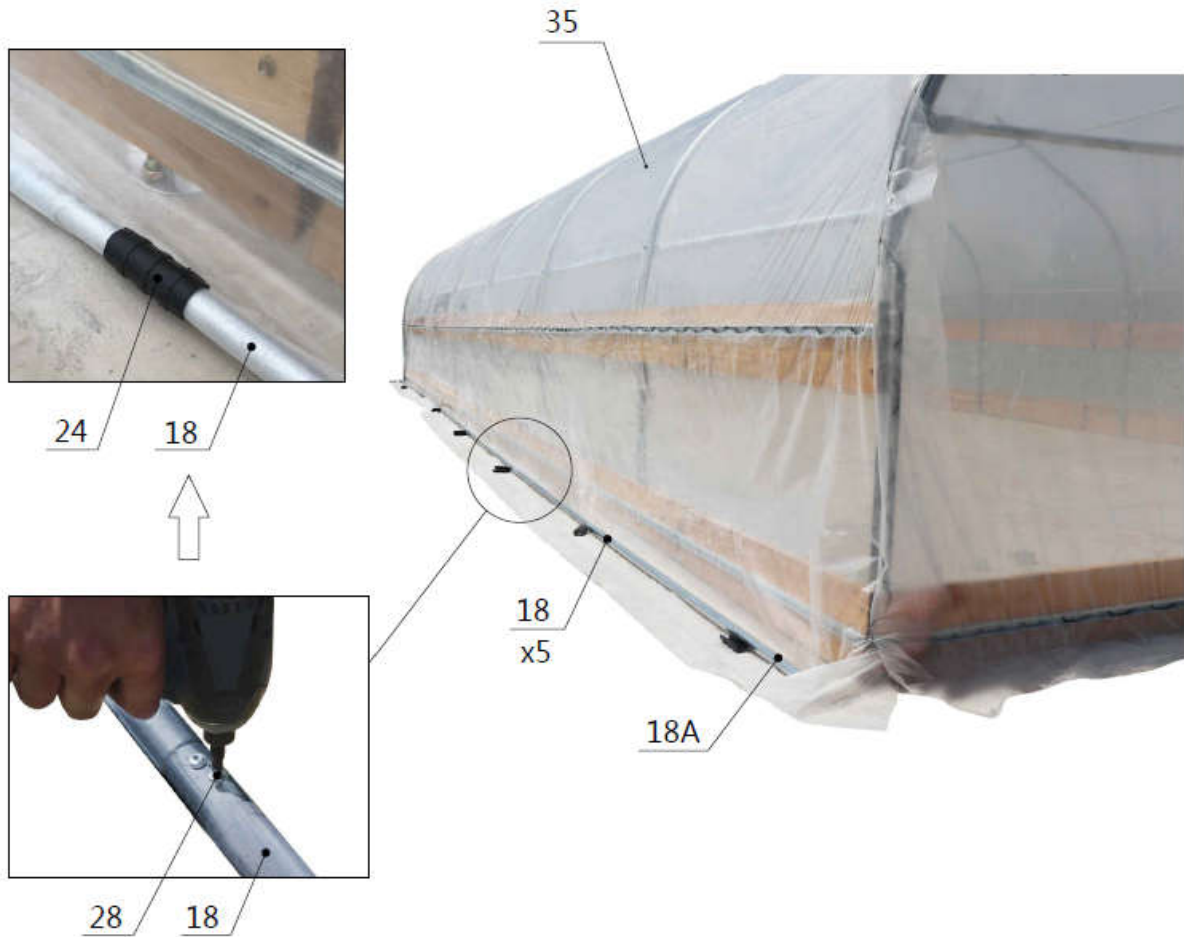
- Install the roll film tube(#18), add a round plug(#32) at the end. the film (#35) is wound on a roll film tube , and clamped with a pressure film carrier (#24).



NO.	PART	QTY
18		10
18A		2
24		20

NO.	PART	QTY
28		20
32		2

- Around plug (#32) is put on both ends of the film rolling machine guide tube (#17), and the guide tube is mounted on the frame with a hex bolt (#27), and it is required to swing freely. The film rolling machine (#21) drives the roll film tube (#18) to be raised and lowered horizontally and flexibly without jamming.
- Install the eight clip spring (#23) and fasten the braided rope (#33).

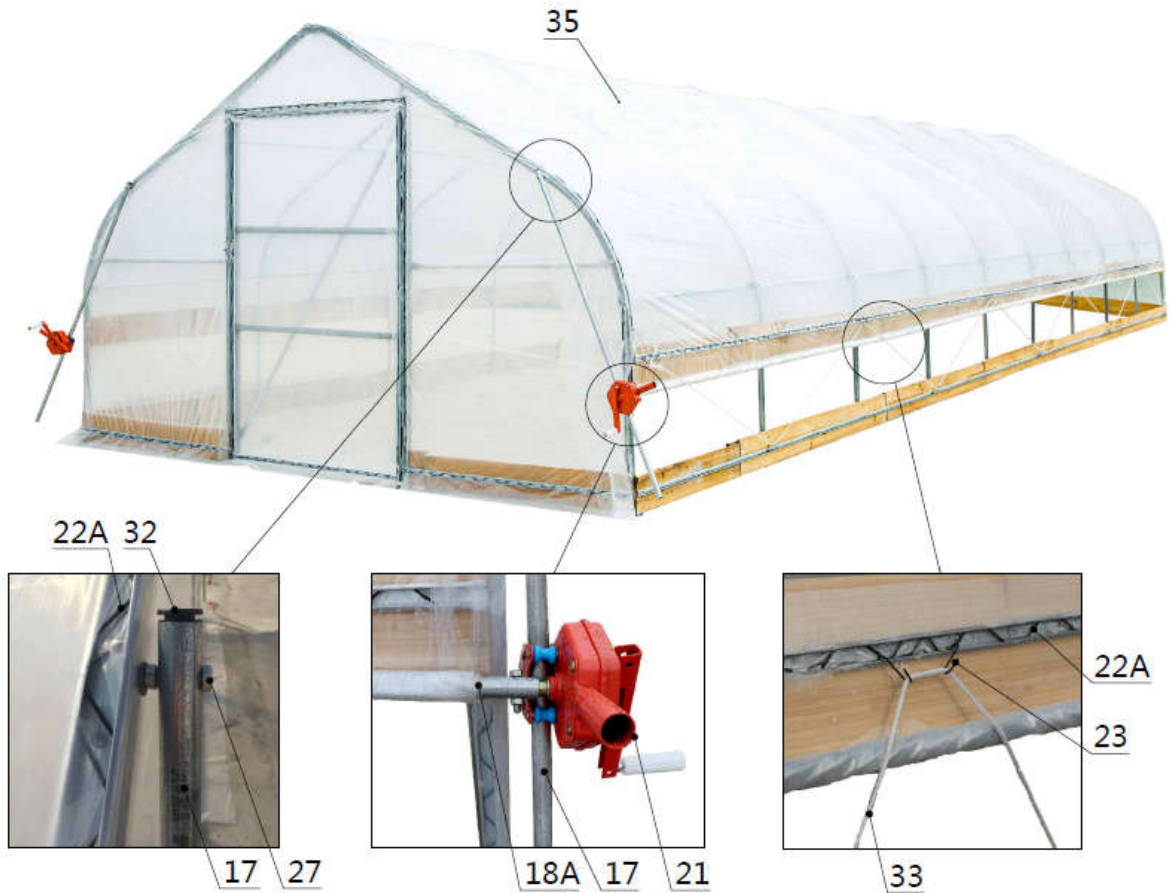

NO.	PART	QTY
17		2
21		2
23		20

NO.	PART	QTY
27		2
32		4
33		1

## **AFTER THE INSTALLATION**

Walk around and inspect the greenhouse periodically to make sure all components are still firmly secured and the whole greenhouse is well supported. Check all bolts and nuts as well as all connection points to make sure they are all in good position.

We strongly recommend you remove any snow from the roof immediately. Do not leave any snow load on the roof overnight. Keep 3 feet of clearance on all sides at all times. Do not allow snow to accumulate and pile up on the sides of the building. Otherwise the pressure from the sides will push inwards and could lead to a collapse.

### **WARRANTY INFORMATION:**

Please refer to our website for detailed warranty conditions and coverage.  
For the most up-to-date and comprehensive warranty information, visit [www.tmgindustrial.com](http://www.tmgindustrial.com)