

# How To Install

## Valance

Wall with Solid Cap | Ceiling / Jamb with Solid Cap

## Tools Needed

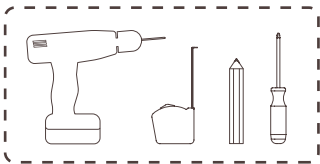

## Need Assistance?

Contact a City Shade Associate for help with Installing.

(877)-224-8974

support@cityshadecompany.com

www.cityshadecompany.com

## Finding The Correct Width

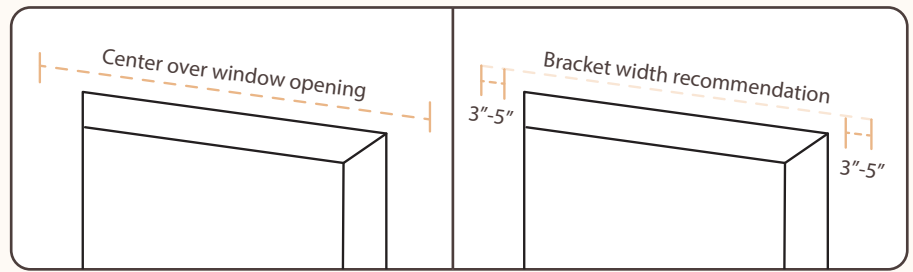

**Finding the Width:** Begin by taking the width measurement of your Valance and center it over the window opening.

After centering, use a pencil to mark on the wall where the Valance ends on each side.

When you install your brackets make sure you install within 3"-5" inward from the marked left and right ends.

Before committing to installing your Valance find your height first.

## Finding The Correct Height

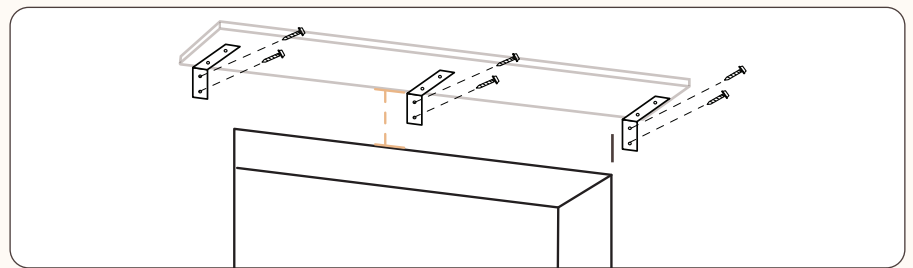

**Finding the height:** You will need minimum of 3" above the window to mount your valance.

However, mount your window covering to your desired height. If there are two people installing this product, always use someone to help hold the Valance up while you confirm your preferred height.

Now you can begin installing your mounting brackets on the left, right and center of the valance.

## Finding The Correct Height

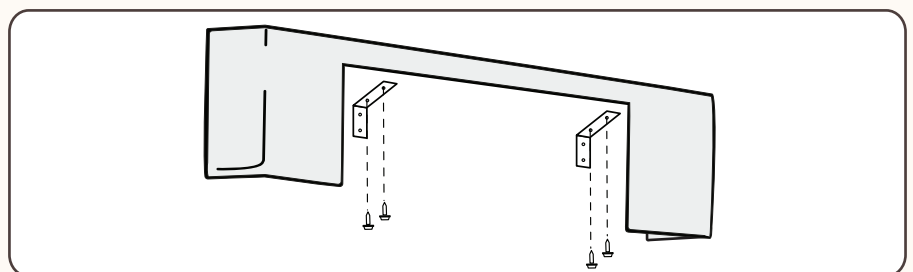

**Installing The Valance:** After Installing your brackets to the correct width and desired height, place your valance over the brackets, center over the window once more.

Once all is centered screw your Valance in to the top of the brackets.

# How To Install

## Valance

## Ceiling / Jamb with Reduced Cap

## Tools Needed

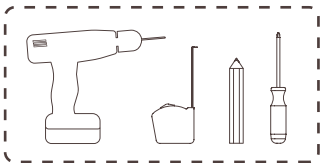

## Need Assistance?

Contact a City Shade Associate for help with Installing.

(877)-224-8974

support@cityshadecompany.com

www.cityshadecompany.com

## Finding The Correct Width

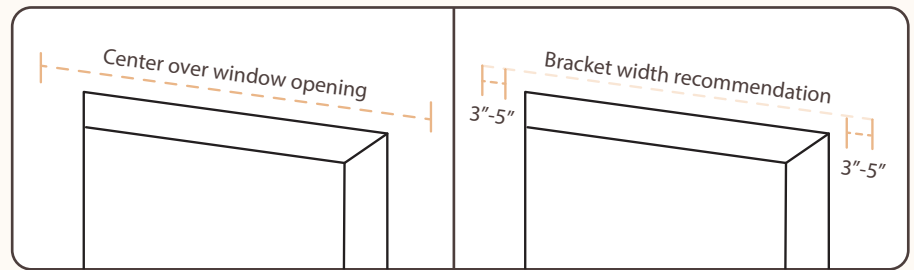

**Finding the Width:** Begin by taking the width measurement of your Valance and center it over the window opening.

After centering, use a pencil to mark on the wall where the Valance ends on each side.

When you install your Z-Brackets make sure you install within 3"-5" inward from the marked left and right ends.

## Finding The Correct Height

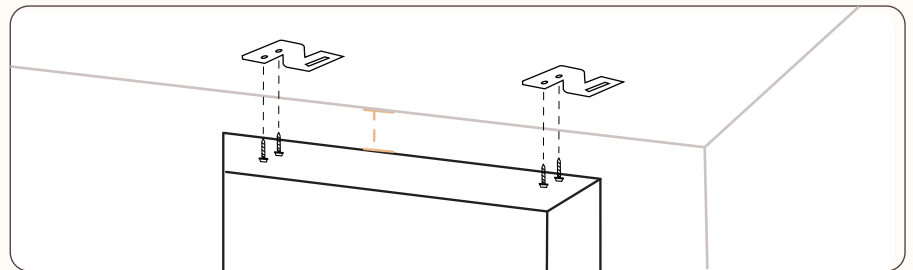

**Ceiling/Jamb Reduced Cap:** Typically mount directly to the ceiling or inside the window jamb.

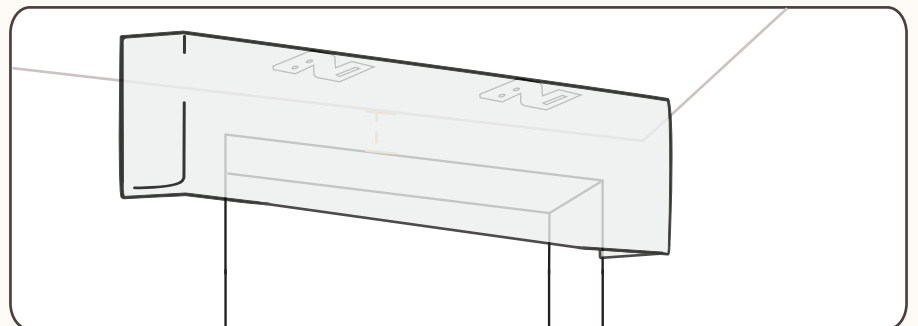

**Installing The Valance:** After Installing your brackets to the correct width place your valance over the brackets, center over the window once more.

Once all is centered screw your valance into the top slot in the brackets.