

How To Install

Cornice

Tools Needed

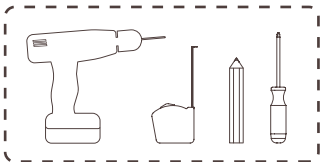

Need Assistance?

Contact a City Shade Associate for help with Installing.

(877)-224-8974

support@cityshadecompany.com

www.cityshadecompany.com

Finding The Correct Width

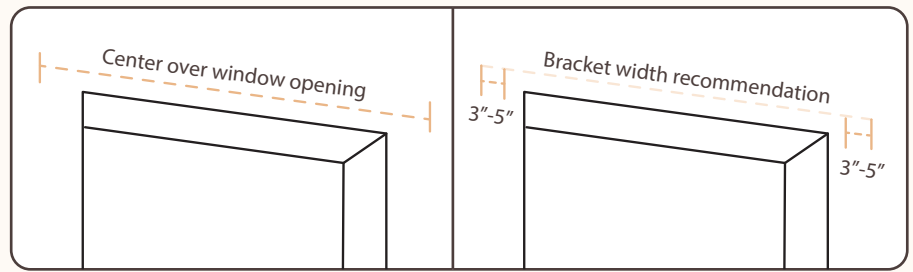

Finding the Width: Begin by taking the width measurement of your Cornice and center it over the window opening.

After centering, use a pencil to mark on the wall where the Cornice ends on each side.

When you install your brackets make sure you install within 3"-5" inward from the marked left and right ends.

Before committing to installing your Cornice find your height first.

Finding The Correct Height

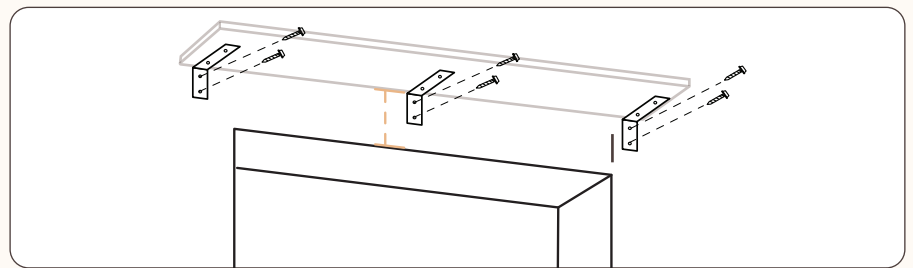

Finding the height: You will need minimum of 3" above the window to mount your cornice.

However, mount your window covering to your desired height. If there are two people installing this product, always use someone to help hold the Cornice up while you confirm your preferred height.

Now you can begin installing your mounting brackets on the left, right and center of the cornice.

Finding The Correct Height

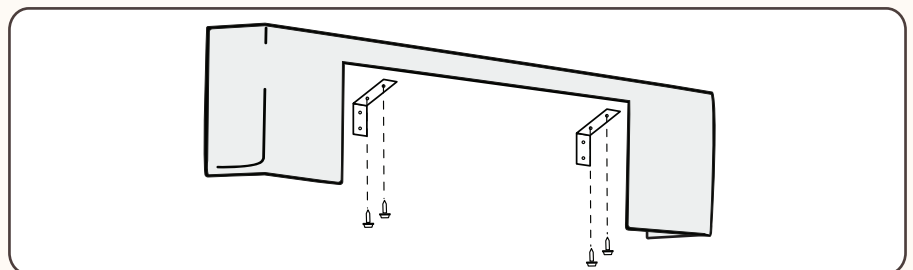

Installing The Cornice: After Installing your brackets to the correct width and desired height, place your cornice over the brackets, center over the window once more.

Once all is centered screw your Cornice in to the top of the brackets.

How To Install

Cornice

Tools Needed

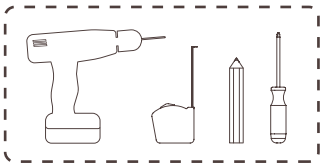

Need Assistance?

Contact a City Shade Associate for help with Installing.

(877)-224-8974

support@cityshadecompany.com

www.cityshadecompany.com

Finding The Correct Width

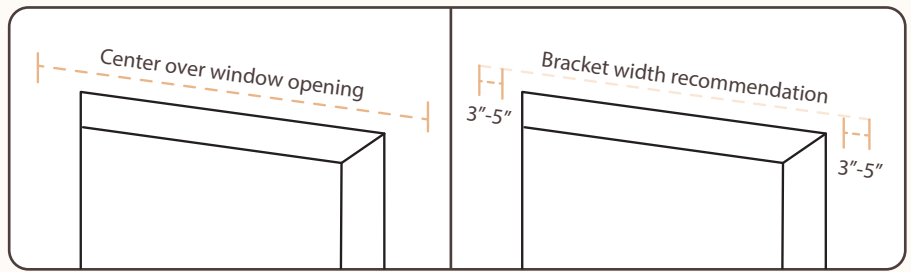

Finding the Width: Begin by taking the width measurement of your Cornice and center it over the window opening.

After centering, use a pencil to mark on the wall where the Cornice ends on each side.

When you install your Z-Brackets make sure you install within 3"-5" inward from the marked left and right ends.

Finding The Correct Height

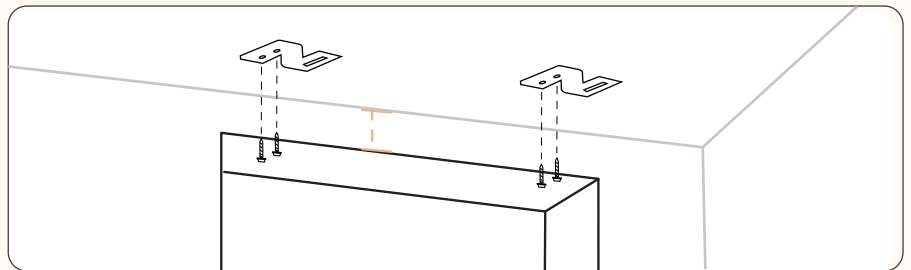

Ceiling/Jamb Reduced Cap: Typically mount directly to the ceiling or inside the window jamb.

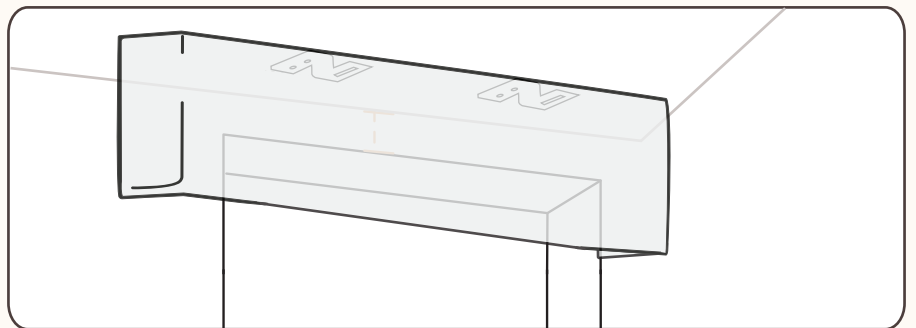

Installing The Cornice: After Installing your brackets to the correct width place your cornice over the brackets, center over the window once more.

Once all is centered screw your cornice into the top slot in the brackets.