

# How To Install

## Select Your Roller Shade

### IMPORTANT

This PDF is interactive. Choose the product that best fits your order, PDF will guide you to the proper installation guide. For control options refer to our “How to Operate” document.

Visual Guides 

## Roller Shade Selections

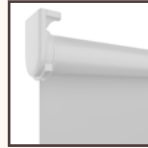

**Decor/Ultra Bracket**

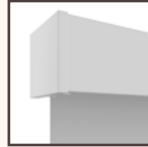

**3” Fascia**

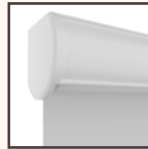

**Fabric Cassette**

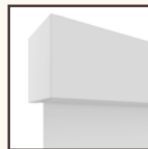

**Square Cassette**

## Day/Night Roller Selections

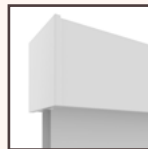

**5” Fascia**

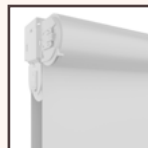

**Standard Dual Bracket**

# How To Install

## Decor & Ultra Brackets

### WARNING

\*According to the Window Covering Manufacturers Association Inc., all labels must not be removed from the product.

\*To comply with child safety standards, all tension devices must be installed.

[Click](#) for Tension Device Guide

### Items Needed

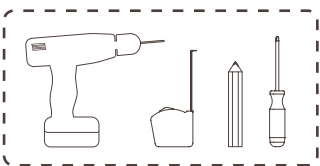

### Need Assistance?

Contact a City Shade Associate for help with Installing.

(877)-224-8974

support@cityshadecompany.com

www.cityshadecompany.com

## Installing Brackets

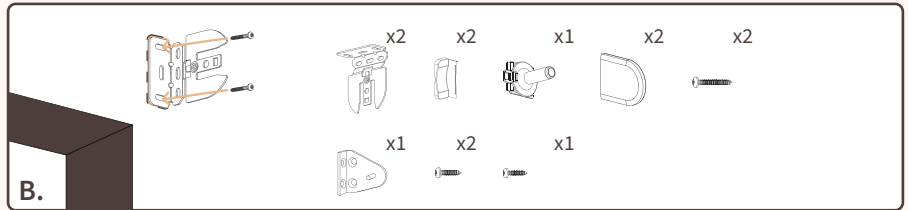
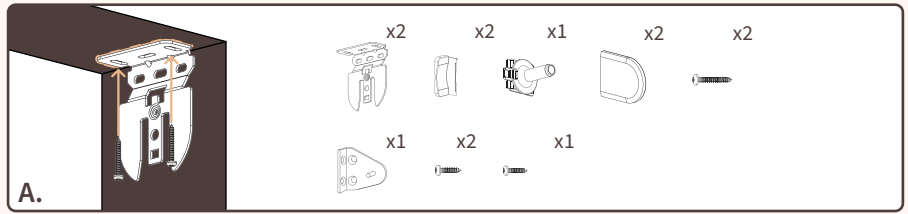

**A. Inside Mount:** Install brackets snug to window frame side.

**B. Outside Mount:** Measure total width of shade and center over the window opening. The start and end of measurement is where brackets will be installed. We recommended installing 3” above window.

Please note that your brackets must be securely attached to the mounting surface. If the screws provided do not hit wood studs you’ll have to use a different fastener which can be found at any hardware store.

**NOTE:** Keep the roller shade up-rolled, do not unroll before installation.

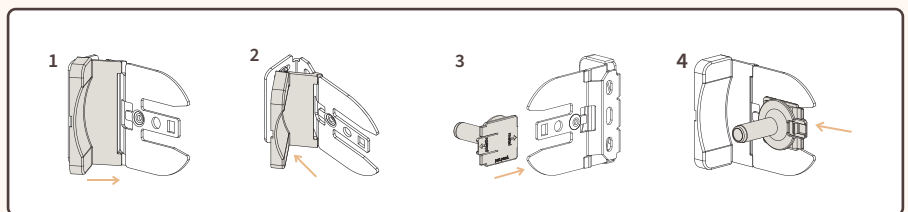

After mounting brackets insert screw cap and bearing pin.

## Installing Shade

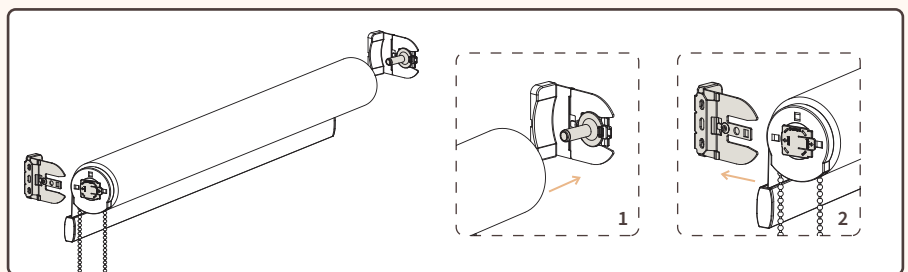

Begin with installing bearing pin side first, once fully inserted slide in the control side until you hear a slight click.

# How To Install

## Decor & Ultra Brackets

### WARNING



\*Young children can strangle in the loop of pull cords, chains and tapes, and cords that operate window coverings.

\*To avoid strangulation and entanglement, keep cords out of the reach of young children. Cords may become wrapped around a child's neck

\*Do not tie cords together. Make sure cords do not twist together and form a loop.

[Click](#) for Tension Device Guide

## Need Assistance?

Contact a City Shade Associate for help with Installing.

(877)-224-8974

[support@cityshadecompany.com](mailto:support@cityshadecompany.com)

[www.cityshadecompany.com](http://www.cityshadecompany.com)

## Installing Cordless Version

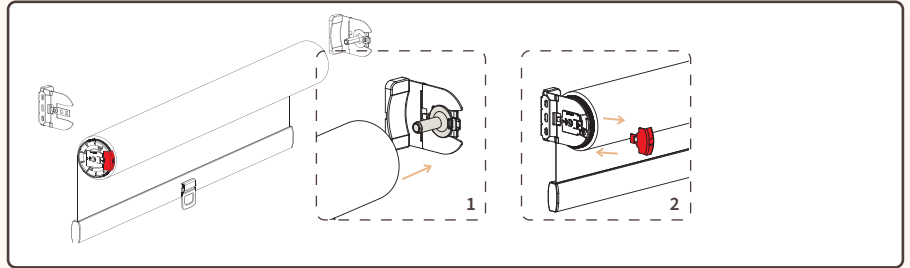

Begin with installing bearing pin side first, once fully inserted slide in the side with red clip. The red clip will pop off the shade once the shade is installed. Please note the red clip should not be taken off prior to installing on to bracket.

## Installing End Caps

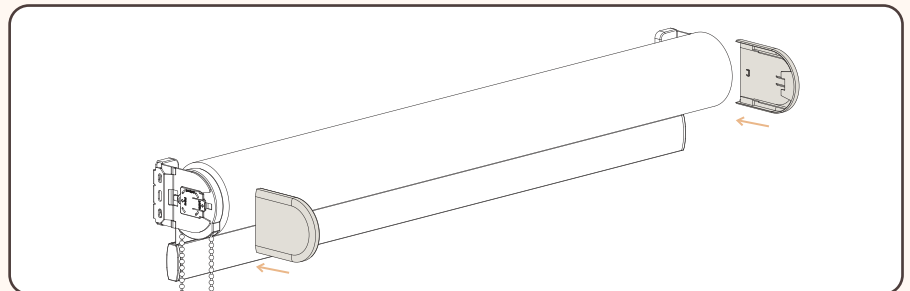

Once successfully installed place the bracket coverings on the roller shade brackets.

# How To Install

## 3” Fascia

### WARNING

\*According to the Window Covering Manufacturers Association Inc., all labels must not be removed from the product.

\*To comply with child safety standards, all tension devices must be installed.

[Click](#) for Tension Device Guide

### Items Needed

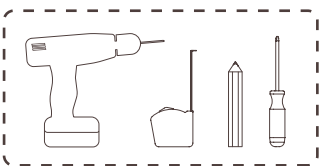

### Need Assistance?

Contact a City Shade Associate for help with Installing.

(877)-224-8974

support@cityshadecompany.com

www.cityshadecompany.com

## Installing Brackets

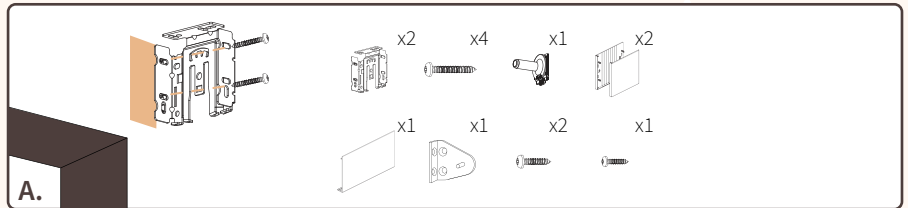
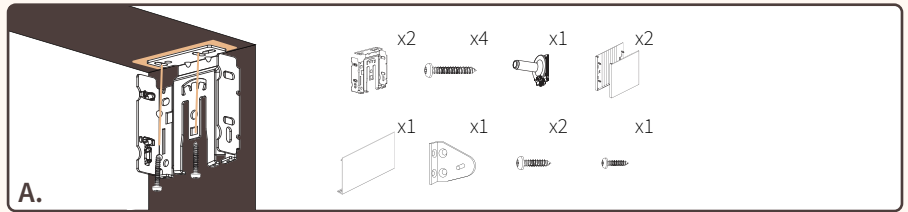

**A. Inside Mount:** Mount brackets snug to window frame.

**B. Outside Mount:** Measure total width of shade and center over the window frame. At the start and end of measurement is where brackets will sit. We recommended installing 3.25” above window opening.

Brackets must be securely attached to the mounting surface. If the screws provided do not hit wood studs you’ll have to use a different fastener which can be found at any hardware store.

**NOTE:** Keep the roller shade up-rolled, do not unroll before installation.

## Installing Shade

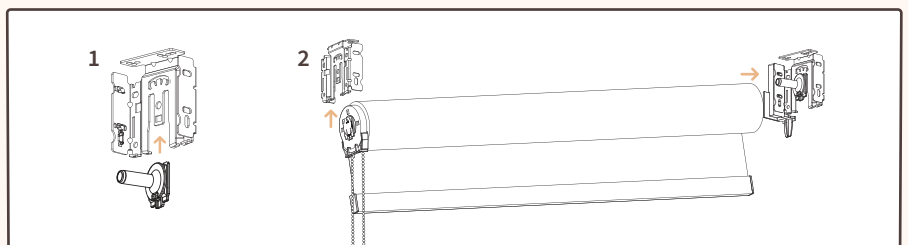

**Step 1-2:** Before installing shade, install bearing pins to the brackets. To install shade slide bearing pin side of shade in first. Then begin to slide the chain side up in to bracket.

# How To Install

## 3” Fascia

### WARNING



\*Young children can strangle in the loop of pull cords, chains and tapes, and cords that operate window coverings.

\*To avoid strangulation and entanglement, keep cords out of the reach of young children. Cords may become wrapped around a child's neck

\*Do not tie cords together. Make sure cords do not twist together and form a loop.

[Click](#) for Tension Device Guide

## Need Assistance?

Contact a City Shade Associate for help with Installing.

(877)-224-8974

[support@cityshadecompany.com](mailto:support@cityshadecompany.com)

[www.cityshadecompany.com](http://www.cityshadecompany.com)

## Installing Cordless Shade

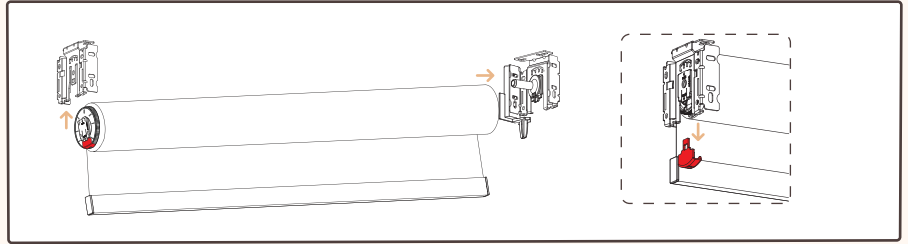

When installing cordless version, reference the same steps on page 1. The side with the spring lock (red clip) is to be installed after the bearing side. The lock will pop off once installed. Do not remove the lock before the shade has been installed.

## Installing Caps & Cover

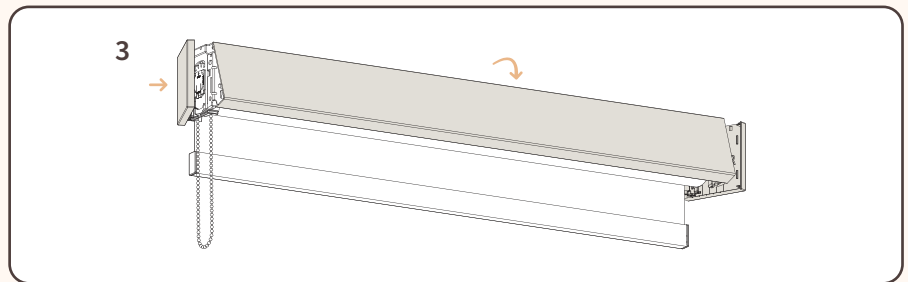

**Step 3:** Complete shade by installing fascia cover then install end caps and enjoy.

# How To Install

## Fabric Cassette

### WARNING

\*According to the Window Covering Manufacturers Association Inc., all labels must not be removed from the product.

\*To comply with child safety standards, all tension devices must be installed.

[Click](#) for Tension Device Guide

### Items Needed

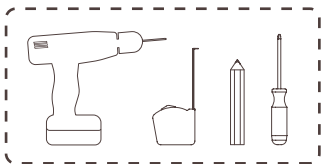

### Need Assistance?

Contact a City Shade Associate for help with Installing.

(877)-224-8974

support@cityshadecompany.com

www.cityshadecompany.com

## Installing Brackets

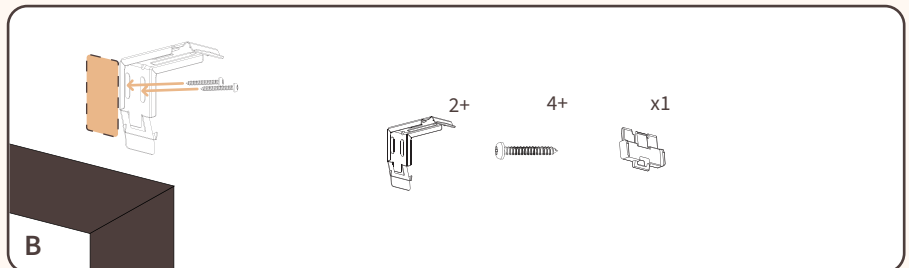
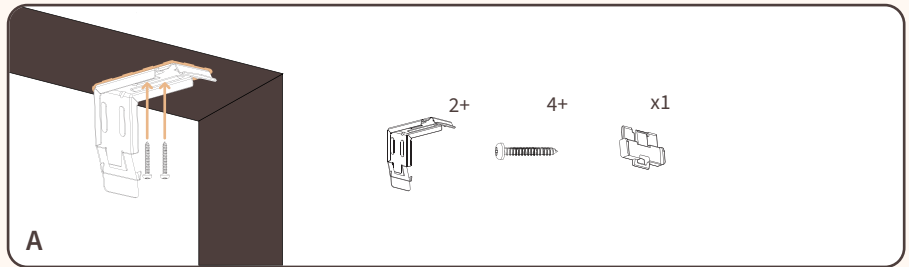

**A. Inside Mount:** Place brackets minimum 2" from the side frame.

**B. Outside Mount:** Measure the total width of shade, then center over the window frame. Place the brackets minimum of 2" in from each end. We recommend installing 3" above window frame.

Brackets must be securely attached to the mounting surface. If the screws provided do not hit wood studs you'll have to use a different fastener which can be found at any hardware store.

**NOTE:** Keep the roller shade up-rolled, do not unroll before installation.

## Installing Shade

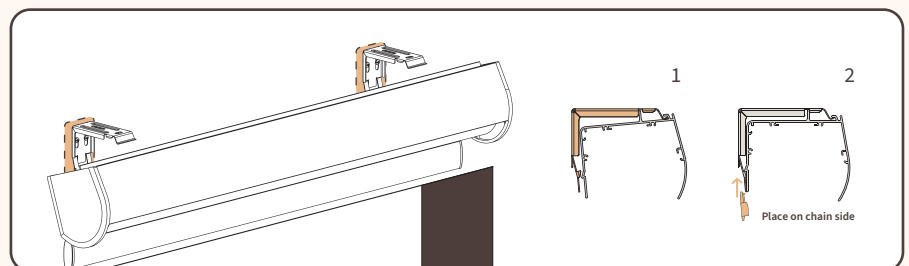

Begin with sliding shade in back end lowered with back end lowered enough for lip of bracket to make contact with lip on top of cassette. Once contact is made begin to lift back end up until you hear a click.

Then place stability block on chain side between mount and wall.

# How To Install

## Square Cassette

### WARNING

\*According to the Window Covering Manufacturers Association Inc., all labels must not be removed from the product.

\*To comply with child safety standards, all tension devices must be installed.

[Click](#) for Tension Device Guide

### Items Needed

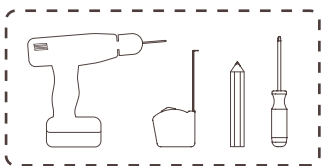

### Need Assistance?

Contact a City Shade Associate for help with Installing.

(877)-224-8974

support@cityshadecompany.com

www.cityshadecompany.com

## Installing Brackets

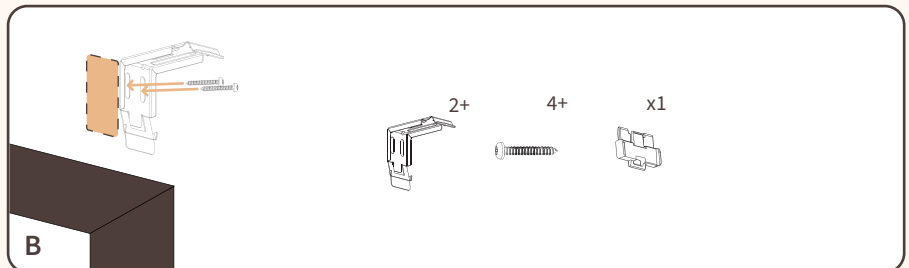
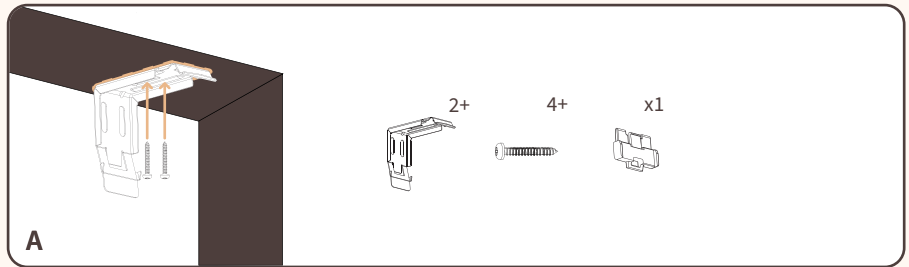

**A. Inside Mount:** Place brackets minimum 2" from the side frame.

**B. Outside Mount:** Measure the total width of shade, then center over the window frame. Place the brackets minimum of 2" in from each end. We recommend installing 3" above window frame.

Please note that your brackets must be securely attached to the mounting surface. If the screws provided do not hit wood studs you'll have to use a different fastener which can be found at any hardware store.

**NOTE:** Keep the roller shade up-rolled, do not unroll before installation.

## Installing Shade

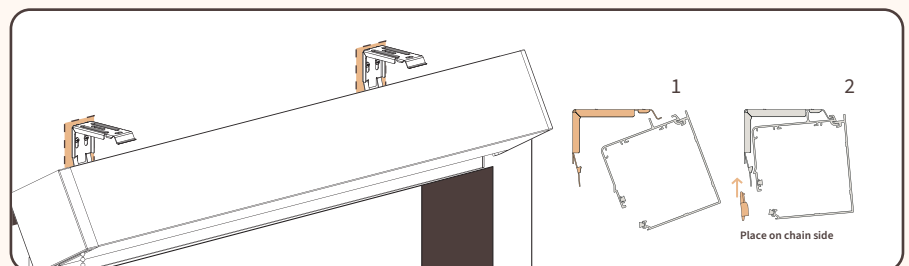

Begin with sliding shade in back end lowered with back end lowered enough for lip of bracket to make contact with lip on top of cassette. Once contact is made beg in to lift back end up until you hear a click.

Then place stability block on chain side between mount and wall.

# How To Install

## Square Cassette with Side Profiles

### WARNING



\*Young children can strangle in the loop of pull cords, chains and tapes, and cords that operate window coverings.

\*To avoid strangulation and entanglement, keep cords out of the reach of young children. Cords may become wrapped around a child's neck

\*Do not tie cords together. Make sure cords do not twist together and form a loop.

[Click](#) for Tension Device Guide

## Need Assistance?

Contact a City Shade Associate for help with Installing.

(877)-224-8974

[support@cityshadecompany.com](mailto:support@cityshadecompany.com)

[www.cityshadecompany.com](http://www.cityshadecompany.com)

## Installing Side channels

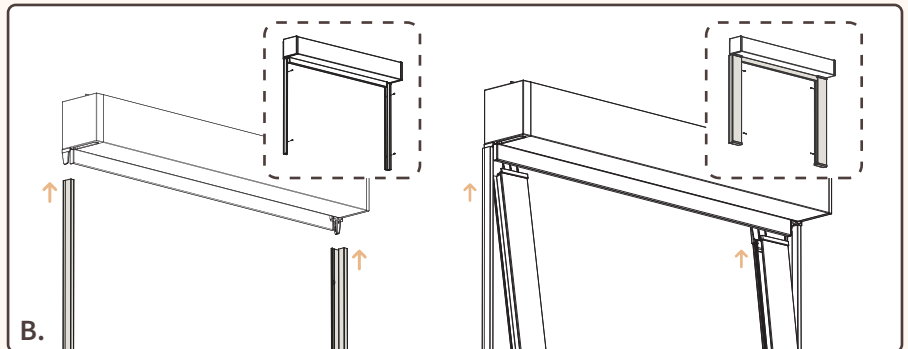
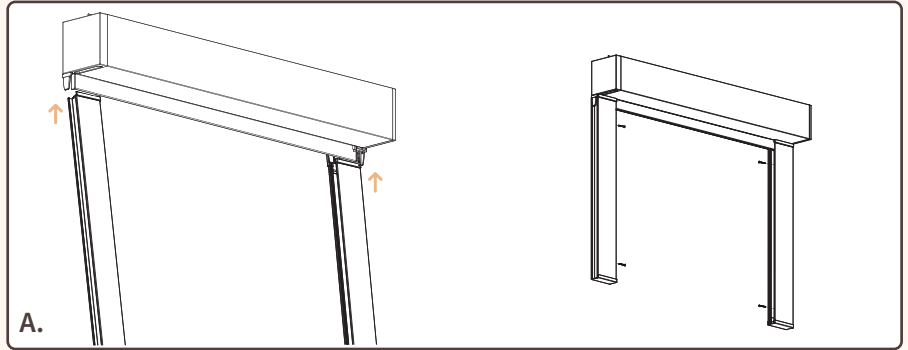

**A. Inside Mount:** Side profiles will need to slide in to hem bar before installing profiles to window frame. Use provided flat headed screws and pre-drilled holes to secure.

**B. Inside Mount:** Follow inside mount steps to install side profiles to profile mounts instead of window frame. Install side profile mounts first by sliding mounts up in to profile connectors, once connected use provided flat headed screws and pre-drilled holes to secure.



# How To Install

## 5" Fascia

### WARNING

\*According to the Window Covering Manufacturers Association Inc., all labels must not be removed from the product.

\*To comply with child safety standards, all tension devices must be installed.

[Click](#) for Tension Device Guide

### Items Needed

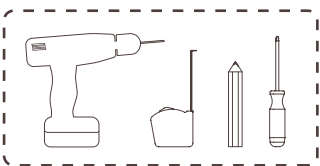

### Need Assistance?

Contact a City Shade Associate for help with Installing.

(877)-224-8974

support@cityshadecompany.com

www.cityshadecompany.com

## Installing Brackets

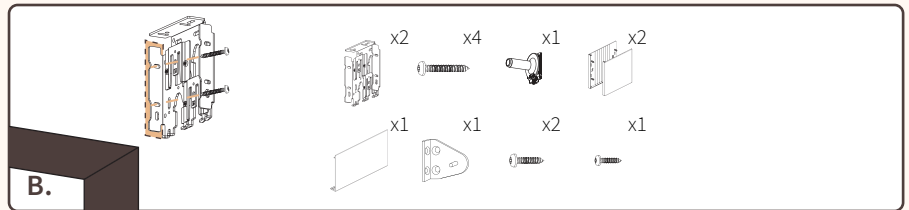
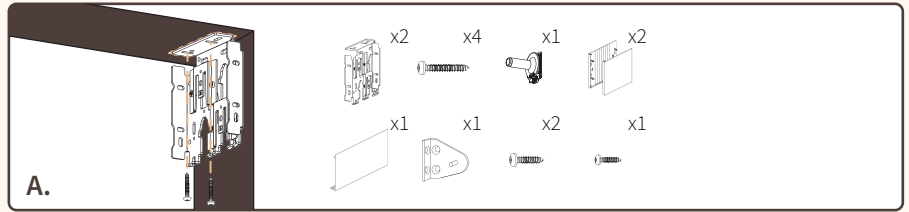

**A. Inside Mount:** Mount brackets snug to window frame.

**B. Outside Mount:** Measure total width of shade and center over the window frame. At the start and end of measurement is where brackets will sit. We recommended installing 5.5" above window opening.

Brackets must be securely attached to the mounting surface. If the screws provided do not hit wood studs you'll have to use a different fastener which can be found at any hardware store.

**NOTE:** Keep the roller shade up-rolled, do not unroll before installation.

## Installing Shades

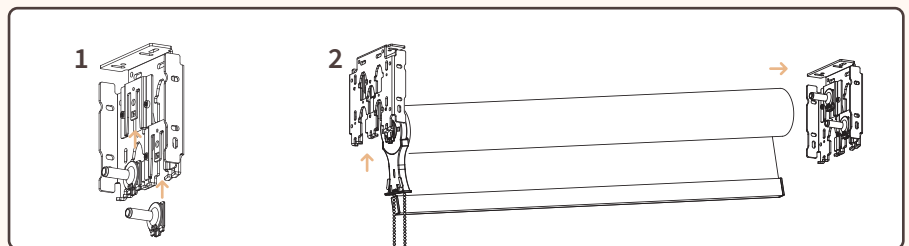

**Step 1:** Before installing shades, bearing pins must be installed in to bracket.

**Step 2:** Insert bearing pin side of shade first, then slide chain side up in to bracket.

# How To Install

## 5” Fascia

### WARNING



\*Young children can strangle in the loop of pull cords, chains and tapes, and cords that operate window coverings.

\*To avoid strangulation and entanglement, keep cords out of the reach of young children. Cords may become wrapped around a child's neck

\*Do not tie cords together. Make sure cords do not twist together and form a loop.

[Click](#) for Tension Device Guide

## Need Assistance?

Contact a City Shade Associate for help with Installing.

(877)-224-8974

[support@cityshadecompany.com](mailto:support@cityshadecompany.com)

[www.cityshadecompany.com](http://www.cityshadecompany.com)

## Installing continued

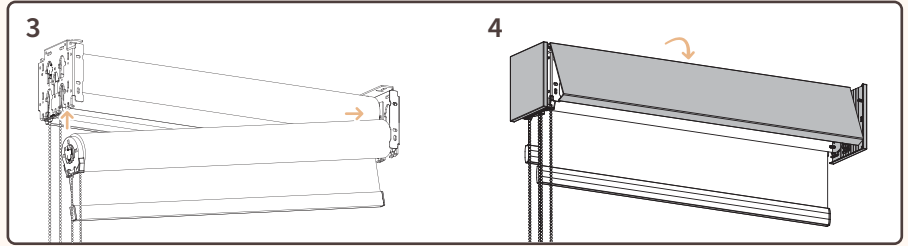

**Step 3:** Repeat step 2 with second shade.

**Step 4:** Begin with placing fascia cover over shades, follow step with inserting end caps to each end.

## Installing continued

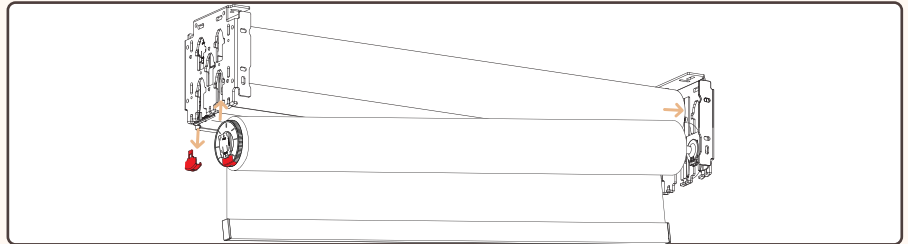

When installing cordless version, reference the same steps on page 1 & 2 . The side with the spring lock (red clip) should be installed after bearing side. The lock will pop off once installed. Do not remove the lock before the shade has been installed.

# How To Install

## Standard Dual Bracket

### WARNING

\*According to the Window Covering Manufacturers Association Inc., all labels must not be removed from the product.

\*To comply with child safety standards, all tension devices must be installed.

[Click](#) for Tension Device Guide

### Items Needed

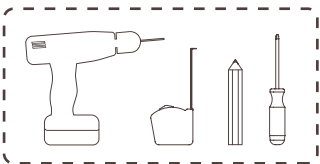

### Need Assistance?

Contact a City Shade Associate for help with Installing.

(877)-224-8974

support@cityshadecompany.com

www.cityshadecompany.com

## Installing Brackets

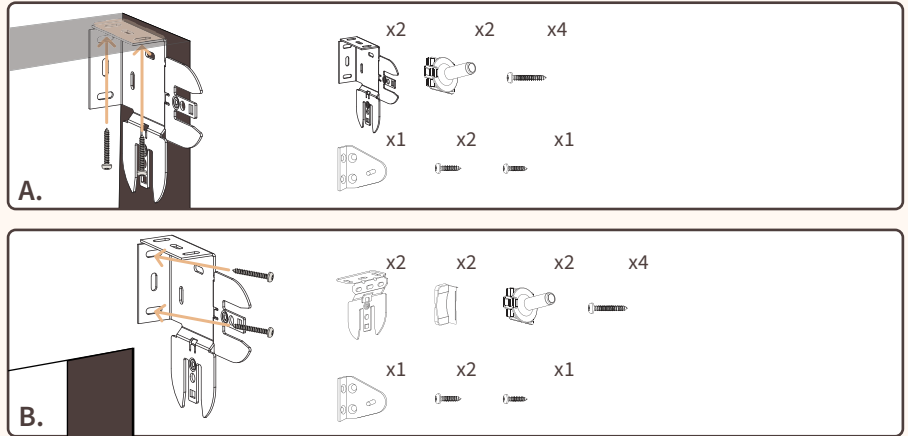

**A. Inside Mount:** Install brackets snug to window frame side.

**B. Outside Mount:** Measure total width of shade and center over the window opening. The start and end of measurement is where brackets will be installed. We recommended installing 5" above window.

Please note that your brackets must be securely attached to the mounting surface. If the screws provided do not hit wood studs you'll have to use a different fastener which can be found at any hardware store.

**NOTE:** Keep the roller shade up-rolled, do not unroll before installation.



After mounting brackets insert bearing pin.

## Installing Shade

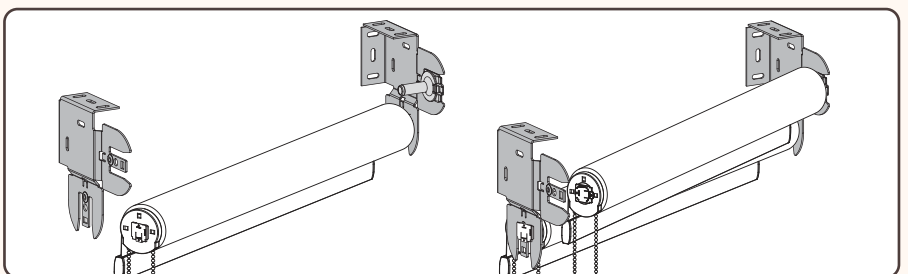

Begin with installing bottom roll first, insert bearing pin side and follow with the control side. Once snapped in to place, repeat with the top roll.

# How To Install

## Standard Dual Bracket

### WARNING



\*Young children can strangle in the loop of pull cords, chains and tapes, and cords that operate window coverings.

\*To avoid strangulation and entanglement, keep cords out of the reach of young children. Cords may become wrapped around a child's neck

\*Do not tie cords together. Make sure cords do not twist together and form a loop.

[Click](#) for Tension Device Guide

## Need Assistance?

Contact a City Shade Associate for help with Installing.

(877)-224-8974

[support@cityshadecompany.com](mailto:support@cityshadecompany.com)

[www.cityshadecompany.com](http://www.cityshadecompany.com)

## Installing Cordless Version

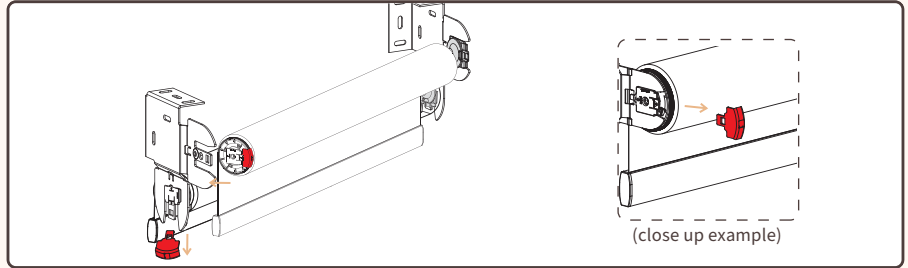

When installing cordless version, insert bearing side following with the side that has the red clip (spring lock), if needed reference page 1 “installing shade” for guidance. It is important to note not to remove the lock on the tension side before installing. When installed the red clip will pop off.

# How To Install

## Safety Tension Device

### WARNING



\*Young children can strangle in the loop of pull cords, chains and tapes, and cords that operate window coverings.

\*To avoid strangulation and entanglement, keep cords out of the reach of young children. Cords may become wrapped around a child's neck

\*Do not tie cords together. Make sure cords do not twist together and form a loop.

## Need Assistance?

Contact a City Shade Associate for help with Installing.

(877)-224-8974

[support@cityshadecompany.com](mailto:support@cityshadecompany.com)

[www.cityshadecompany.com](http://www.cityshadecompany.com)

## Installing Tension Bracket

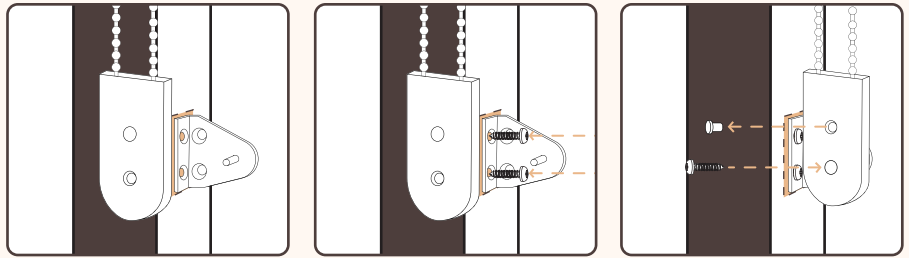

**Step 1:** Pull tension device down to where there is very little slack. Mark the area where the bracket sits.

**Step 2:** When placed in the correct spot, use two screws to secure bracket.

**Step 3:** Place tension device on to bracket, secure with a screw and remove stopper from top hole.