

FOTILE

USER'S HANDBOOK

Please read this instruction manual carefully before using

BUILT-IN ELECTRIC STEAM OVEN

SCD42-C2T / SCD42-F1



Thank you for choosing our products, please read the handbook carefully before use.

CONTENTS



Important safety description	1
Packing list	6
Main technical parameters	6
Circuit diagram	7
Installation method	7
Introduction to product structure	9
Quick use instruction	10
Senior advanced operations	17
Common problems handling	23
Suggestions for cleaning and maintenance	25

Important safety description

In order to prevent damages or property losses to users and other people, the following distinction and identification are made hereby.

The following content is important matters related to safety. Please follow them strictly and use them properly based on fully understanding.

Content difference according to hazard and damage degree





	Warning	Ignorance of the identification and faulty operation may lead to personal injury, serious injury or fire.
	Caution	Ignorance of the identification and faulty operation may lead to personal injury or goods damage.
	Advice	Content to be understood for the safety and proper use.

Icon of caution and forbidden content



 **Caution:** tempered glass in product of the Company goes through quality monitoring . However, tempering mechanism of the glass determines small probability for explosion of tempered glass.

• **Special description:** please use the product in strict accordance with the instruction book. The Company will not be responsible for property loss and personal injury due to improper use.

 Warning	
	Please do not use loose or bad contact power plug, which may lead to electric leakage, short circuit and fire.
	If flexible power supply wire is damaged, please replace it with special flexible wire or special module bought from the manufacturer or repair department; flexible power supply wire must be replaced by special personnel of manufacturer.
	Please open the door of steam oven after 30-60 seconds after completion of operation. Vapor will come out when the door is open. In order to prevent vapor scald, please keep away from it.

Warning



To ensure safety, there should be reliable grounding line of plug. Grounding line should not be connected to gas pipe, tap water pipe, lightning rod and telephone wire. Bad grounding may lead to electric shock or other accidental events.



It can not be used by children and person with limited activity. Keep it away from children; otherwise it may lead to scald, electric shock and other accidental events.



Only professional personnel can disassemble the machine to repair it or replace parts.



The product is for family daily use only. Do not use it for commercial purpose or use it in other special environment.

Caution



Electric steam oven will get hot during usage. Pay attention to avoid getting touch with hot element in steam oven.



The power must be cut off during cleaning. Please use neutral cleaning agent and soft cloth to wipe and wash to prevent from scratching surface.



The whole machine should stay away from inflammable substance such as hot resource, gas and alcohol.



Please do not touch steam oven when hands and feet are wet or feet are naked.



Please put heavy substance on the opening steam oven door.



Do not use multifunctional socket which connects many plugs.



The plug must be pulled off by handling end of the plug. Do not pull off the plug by handling the line. Otherwise it will bring dangers such as an electric shock and short circuit, firing and so on.



Do not use tough cleaning agent or sharp metal knife to clean glass of steam chamber door. Because knife scratches glass surface and results in broken glass.

Suggestion

- The product is only used for family cooking. It will bring risks for other purposes. We will not assume the responsibility of any personnel damage or property loss resulting from deviation of requirement of the instruction.
- Clean the machine before first time use. Take out the water tank at first and wash its inner part with hot water. Do not use any cleaning liquid or agent; inner side scaffold of inner container and attachment can also be taken out for a wash. (Please refer to Maintenance and Cleaning section); it is suggested to use cleaning liquid diluted by hot water to clean inner container and inner wall of steam oven.
- In order to keep it clean, please pour out redundant water after being used each time to avoid concentrated condensate in the machine.

Suggestion

- After being used each time, soft cloth should be used to wipe condensate water groove.
- Open the steam oven door and let damp air disperse until it becomes dry completely.
- If the machine is left alone for a time (for example spending holidays), the machine should be cleaned at first. Then open the steam oven door to avoid peculiar smell.
- Wipe the water in the groove bottom of water tank with cloth at each time of adding water into the water tank.
- When steam oven is not in use, you should ensure it is in close status at first.
- When steam oven function is not unusual, please pull off the power and plug in again. If the problem is not solved, please refer to "Recognition and Treatment on Common problem" for corresponding treatment.
- In order to enhance protection, it is suggested to wear hot insulation gloves when carrying hot vessel at hand. The gloves should avoid being wet otherwise the heat passed through the gloves quickly to cause scald.

Important Instruction

- Proper Installation – Be sure your appliance is properly installed and grounded by a qualified technician.
- Never Use Your Appliance for Warming or Heating the Room.
- Do Not Leave Children Alone – Children should not be left alone or unattended in area where appliance is in use. They should never be allowed to sit or stand on any part of the appliance.
- Wear Proper Apparel – Loose-fitting or hanging garments should never be worn while using the appliance.
- User Servicing – Do not repair or replace any part of the appliance unless specifically recommended in the manual. All other servicing should be referred to a qualified technician.
- Storage in or on Appliance – Flammable materials should not be stored in an oven or near surface units.
- Do Not Use Water on Grease Fires – Smother fire or flame or use dry chemical or foam-type extinguisher.
- Use Only Dry Potholders – Moist or damp potholders on hot surfaces may result in burns from steam. Do not let potholder touch hot heating elements. Do not use a towel or other bulky cloth.
- Use Care When Opening Door – Let hot air or steam escape before removing or replacing food.
- Do Not Heat Unopened Food Containers – Build-up of pressure may cause container to burst and result in injury.
- Keep Oven Vent Ducts Unobstructed.
- Placement of Oven Racks – Always place oven racks in desired location while oven is cool. If rack must be moved while oven is hot, do not let potholder contact hot heating element in oven.

Safety of installation and maintenance

- Before using the machine for the first time, please read important instruction relative to safe machine usage, operation and maintenance in the instruction manual to avoid accidents or damages.
- Ensure the family power voltage and frequency is accordant with that of machine before steam oven installation.
- Ensure your steam oven is handled by specialized service personnel and its safe installation and well grounding. Machine grounding and family grid grounding connection must be ensured to be correct and reliable in order to ensure the electric safety of steam oven. It is a basic safety requirement. The product manufacturer will not assume any responsibility of any damage resulted from problems in family grid.
- Installation, maintenance and repair must be specialized service personnel of FOTILE. Do not install, repair or maintain without authorization.
- The product can not be connected with long distance socket because of its too long cable and it is easily to cause wire overheating and thus brings fire or electric leakage accidents.
- Opening product casing without authorization is forbidden. It is dangerous to touch connection line and electrical element or structure and it may bring electric shock and mechanic trauma.
- Urban transmission line connecting power must be provided with full - pole circuit breaker which can withstand current above 20A independently to satisfy that the steam oven power can be cut off by turn off circuit breaker in case of maintenance or urgent incidents.

Application safety

- Please make sure that the product is installed in cabinet correctively and reliably before operation.
- The product is only used for family cooking and can not be use for cooking of any commercial purpose. There may be safety risk in any other application and may result in personnel damage.
- The power plug or power line can not be immersed by water to prevent dangerous electric shock during using it again.
- From view of safety, please pour out and wipe the water in the water tank to avoid scale.
- After finishing use and cooling, clean the inner container, inner side of door and condensate water groove with clean cloth.
- If it will be not used for a long time, the steam oven should be cleaned completely to avoid peculiar smell. See details in Maintenance and Cleaning section.

About children's safety

- During application, steam comes out from outlet. Even after use, there is still hot temperature on the inner and outer side of the door. Please tell your children to keep a distance with the product for safety.
- When steam oven is in use, it is necessary to take care of children near the product.
- It is forbidden to let your children lean or suspend on the door of the steam oven.
- In order to reduce the risk of damaging your children, do not let your children take the steam oven as plaything or let them play around the steam oven.
- Ensure the plastic bags are saved in place where your children can not reach to prevent suffocating during children playing.

Production safety

- Do not heat the food in the closed container or otherwise it will result in explosion by increasing pressure of container, which is harmful to both machine and operator.
- Please clean and dry the machine after being used each time in time. Because condensed concentration may be corrosive to the machine after a long time.
- Do not use substance that will rust machine or otherwise steam oven will be damaged.
- Try to use the citric acid rust remover when cleaning the rust. Using other rust removers may be harmful to your steam oven.
- Steam cleaner should not be used for cleaning your steam oven because the steam will enter into electric element, which may result in short circuit leading to machine stoppage or even getting an electric shock.
- Please cut off the plug-in strip of steam which supplies chamber power resource in unusual condition and call Service Department of FOTILE for personnel treatment in time. Please stay away from it and do not get close to machine before treatment.
- Relative operations such as maintenance and installation must be finished by professional service staff of FOTILE.

Personnel safety

- The steam oven must be installed at the safe and proper height for convenience of opening or closing the chamber door and taking out food during cooking. Otherwise the coming out steam may scald you. Besides, proper installation height will reduce risks of scalding your child when putting hands on the chamber door.
- Take care of hinge, edge or corner of the chamber door when opening it. Please do not touch it to avoid injury caused by machine.
- Open the chamber door slightly at first when observing or taking out food to let the large amount of steam come out. Then open the chamber door completely to prevent scalding by avoiding the body to touch the steam directly.
- Please take care of the falling drops from condensed water tank when opening the chamber door.
- During cooking, please operate carefully and do not tilt the food in container to make liquid or food come out from the container.
- When getting or putting hot container, please wrap it with thick cloth to prevent it from scalding your hand.
- When removing or moving your steam oven, please pull off power plug of steam oven.

Packing list

Please check whether product and accessory are in a complete set one by one after opening package.

- Please call distributor for treatment if it is the responsibility of us or distributor.
- Please call nearby After-sales Service Centre of company if it is the responsibility of user.

■ Complete machine	1 set	■ Steam tray	1 piece
■ Instruction manual	1 piece	■ Oil-receiving tray	1 piece
■ Sealing ring of water tank interface	2 pieces	■ Wood screw	2 pieces

Main technical parameters

Type	SCD42-C2T/SCD42-F1	Rated capacity	1.48Cu.Ft.
Rated voltage	240V	Net weight	53.6 lbs
Rated power	2400W	Heating method	Steam heating
Rated frequency	60Hz	Control method	Touch

Circuit Diagram

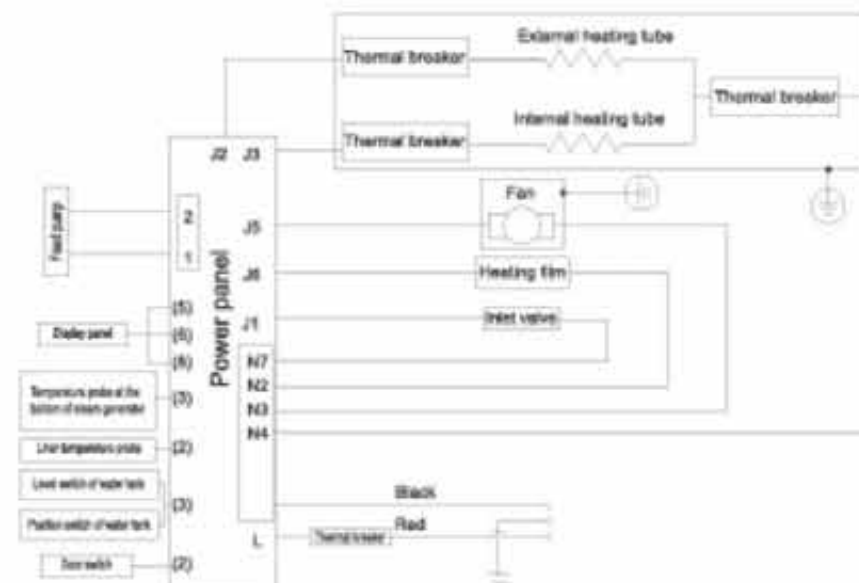

Installation method

- Electric steam oven should be installed at fixed places with easy access for operation and maintenance and should not be installed obliquely.
- Electric steam oven and power outlet should not be installed at places with easy access of being damp or wet by water.
- During removal and placement, electric steam oven should be lifted from handle hole and bottom. Electric steam oven can not be moved by pulling door or handle.
- The electric steam oven is embedded in cabinet. The bottom board of cabinet hole must be able to withstand the weight above 132.3lbs.

Attention: 1. Cabinet material (wood and adhesive) for steam oven installation must be able to withstand the temperature above 212°F.

2. In order to maintain ventilation, the gap larger than 1⁴⁹/₆₄ inches should be saved at the back side.

3. Space larger than 31¹/₂ inches must be saved in front the steam oven during installation.

4. Secure the steam oven to the cabinet with the wood screws in the accessory pack (see the schematic drawing for screwing).

5. The steam oven needs to use 10A socket alone and make sure that the socket contacts well. Do not share it with other electrical steam ovens.

6. After installation, the left, right and upper panels of the steam oven should maintain a distance of more than 1/8 inches from the surrounding walls, cabinets, steam ovens, etc., and the bottom panel of the steam oven should maintain a distance of 7/16 inches or more from the surrounding walls, cabinets, steam ovens, etc.

7. As the steam oven is subject to a full-inspection aging test before delivery, it is normal that there is small amount of residual water remaining in the internal piping and there are a few water droplets in the liner and the water tank.

Remove the outer packaging of the steam oven and the membrane bag, and place the steam oven closer to the mounting hole. One end of the power cord is plugged to the power socket at the back of the steam oven, and the other end is connected to the mains socket (no power). With one hand lifting the steam oven at the grasping location of the steam oven and the other hand supporting the bottom of the steam oven, gently place the steam oven into the hole of the cabinet. Release one hand, and gently push the steam oven to the end. Place the front end of the steam oven on the bottom board of the cabinet. Secure the steam oven to the cabinet with the wood screws in the accessory pack (see the schematic drawing for screwing).

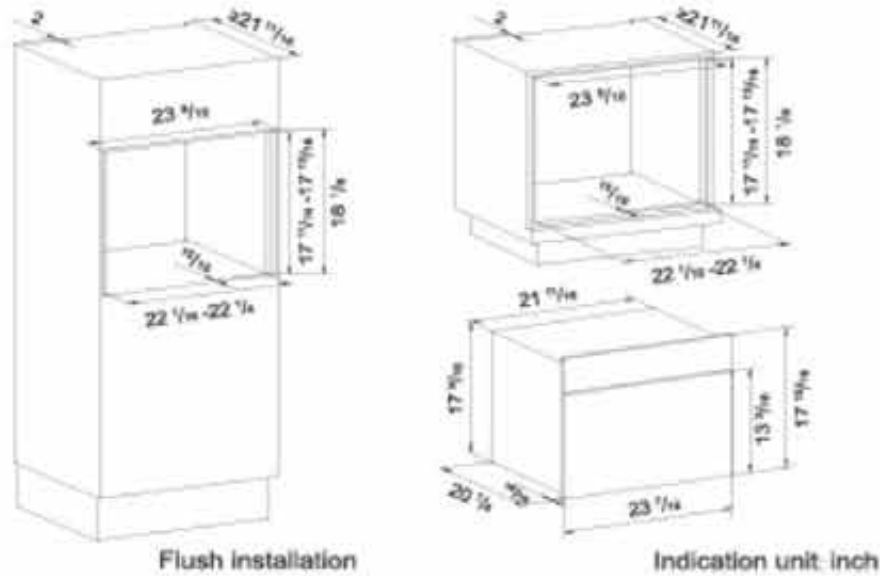

Schematic Drawing for Screwing

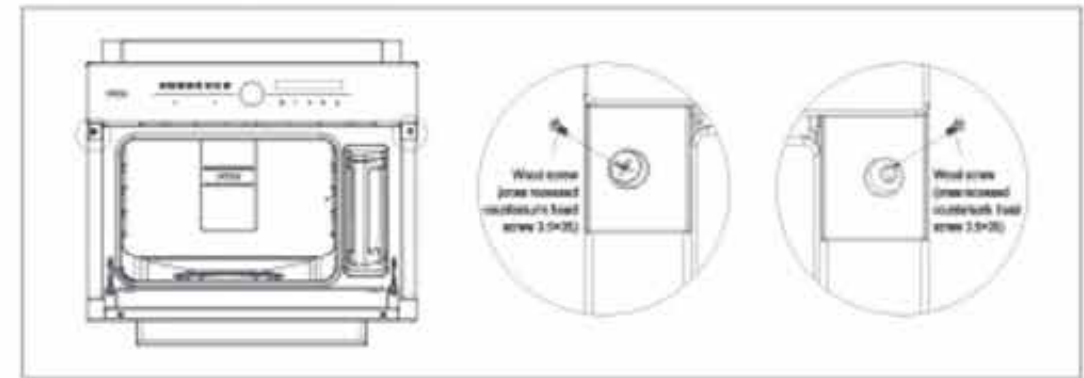

SCD42-C2T

Schematic Drawing for Screwing

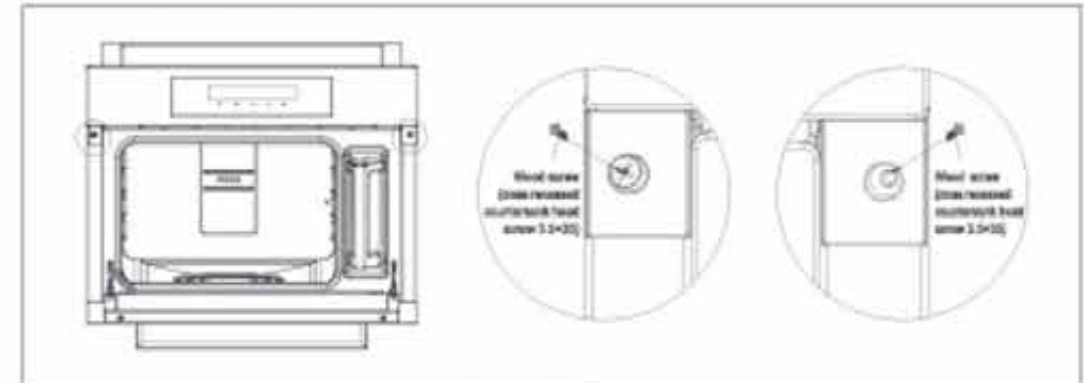

SCD42-F1

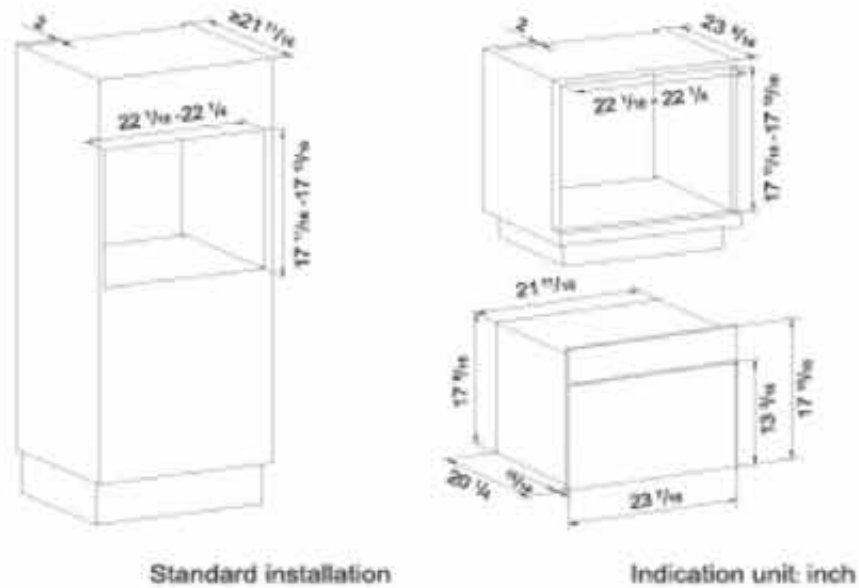

Introduction to product structure

★ SCD42-C2T



- ① Control panel
- ② Touch key
- ③ Display screen
- ④ Erection column for whole machine
- ⑤ Steam oven door
- ⑥ Water tank
- ⑦ Temperature sensor of inner container
- ⑧ Inner container heater
- ⑨ Sealing of rubber door

★ SCD42-F1

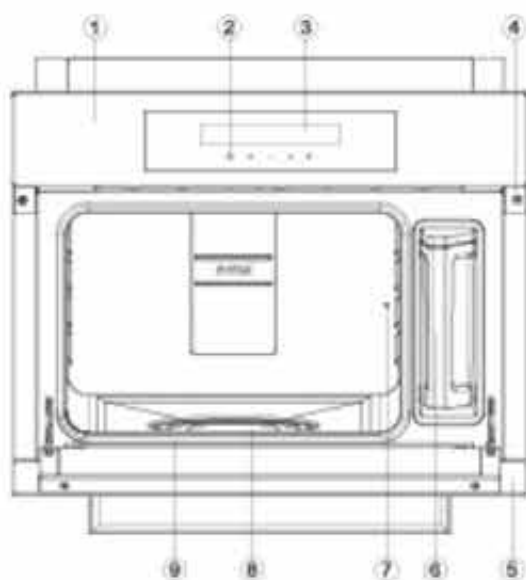

- ① Control panel
- ② Touch Key
- ③ Display screen
- ④ Erection column for whole machine
- ⑤ Steam oven door
- ⑥ Water tank
- ⑦ Temperature sensor of inner container
- ⑧ Inner container heater
- ⑨ Sealing of rubber door

Accompanying accessories

A steam tray with several-hole design:



An oil-receiving tray:



Quick use instruction

★ SCD42-C2T

I. Control panel figure

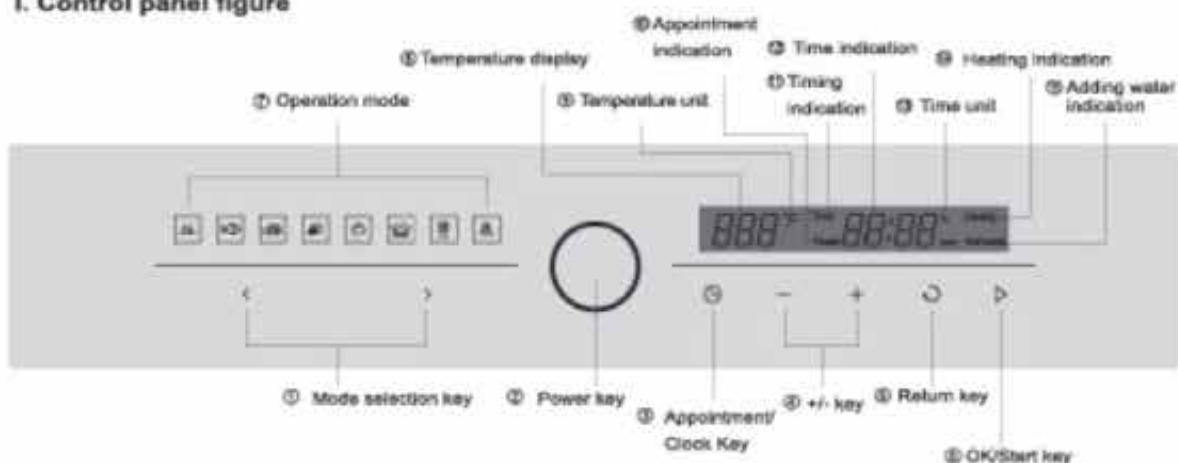

■ Description of the control panel, keys, and display interface

● Operation keys

- ① Mode selection key: Touch this key to select operation mode in a loop.
- ② Power key: Touch this key to turn on. Touch this key to turn off when it is on.
- ③ Appointment/Clock Key: Touch this key to set the clock and appoint cooking time. (See Section: Clock settings, using appointment function for cooking)
- ④ +/- key: Touch this key to set the value required for cooking temperature, cooking time, or clock time.
- ⑤ Return key: During setting, touch this key to return to the previous setting interface: when working, touch this key to return to the mode selection interface.
- ⑥ OK/Start key: Touch this key to confirm the set cooking temperature , time and start cooking.

● Icons and text on the display interface

- ⑦ Operation mode: The operation mode icon is used to identify the available steaming operation mode. There are 8 operation modes available: ordinary steaming, steaming fish , steaming meat, steaming vegetables, steaming pasta, fermenting, defrosting and descaling.
- ⑧ Temperature display: It can display the temperature you set and the real-time temperature inside the steam oven.
- ⑨ Temperature unit: This icon shows the temperature unit you set (°F).
- ⑩ Appointment indication: This icon indicates that you have chosen the appointment mode for cooking.
- ⑪ Timing indication: This icon shows that you are setting or have set the cooking time.
- ⑫ Time indication: It displays the set cooking time and the scheduled countdown time.
- ⑬ Time unit: It displays the unit of time you are setting.
- ⑭ Heating indication: When the icon "heating" is constantly on, it means that the steam oven is in operation. When the door of steam oven is opened during operation, this icon flashes.
- ⑮ Adding water: When this icon flashes, it means you need to add water into the water tank of the steam oven, then push the tank into the tank slot and push it into place.

II. Precautions before every use

■ Water tank filling

Before operation of the steam oven, firstly fill fresh water into the water tank to the highest water level mark of 'MAX', and then insert the water tank into the tank slot, and push it in place. (pure water is preferred).

■ Insert the oil pan (no holes) in the bottom layer of the tank before using the steaming pan (with holes).

Function list

Steaming mode icon	Steaming function	Default temperature (°F)	Default time (min)	Temperature range (°F)	Time range
	Ordinary steaming	212	20	86-212	1 minute - 5 hours
	Steaming fish	212	15	194-212	1 minute - 5 hours
	Steaming meat	212	30	194-212	1 minute - 5 hours
	Steaming vegetables	212	20	194-212	1 minute - 5 hours
	Steaming pasta	212	15	194-212	1 minute - 5 hours
	Fermenting	95	30	95-113	1 minute - 12 hours
	Defrosting	122	30	104-122	1 minute - 5 hours
	Descaling	Fixed settings of program	Fixed settings of program	Fixed settings of program	Fixed settings of program

Note: The default temperature is for reference only. The cooking temperature can be selected according to the characteristics of the cooking ingredients: for example, in the "steaming fish" mode, the default temperature (212°F) is more appropriate when cooking salted or older fish, while when cooking fish with relatively tender meat, cooking temperature and cooking time shall be reduced appropriately. For detailed cooking methods, please refer to the steam oven recipe provided together with the steam oven.

III. Cooking with steam oven

Operation steps: place the dishes in the steam oven → fill water in the tank → turn on the steam oven → select the cooking mode → set the cooking temperature → set the cooking time → confirm and start cooking → finish cooking and shut down → daily cleaning

1. Power on/off

Touch the 'Power' key to turn it on (Operation ①), then enter the mode selection interface; touch the 'Power' key in the power-on state and any operation mode to shut down, and the display screen will go out.

2. Choose the cooking mode

In the mode selection interface, the display screen shows all operation mode icons and the first mode icon flashes. At this time, touch the <, > key to cycle through the mode, touch < to select to the left, touch > to select to the right (Operation ②). For example, when the "ordinary steaming" mode is selected, only the "ordinary steaming" icon will flash in the cooking mode icon displayed on the interface. The display interface at this time is shown in the figure below.

Note: The icon or text "Flash" mentioned in the manual is to remind you to set the corresponding item.

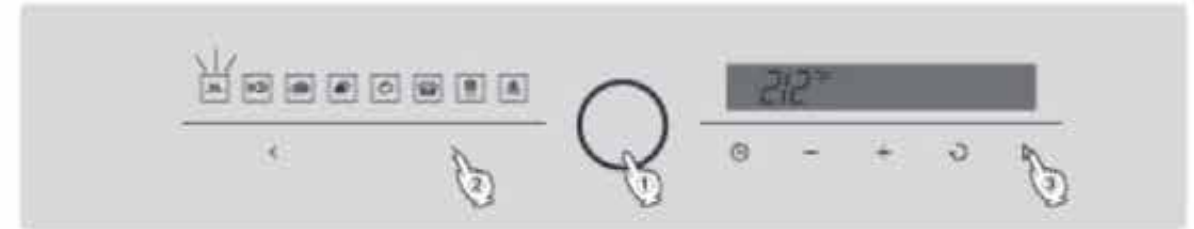

3. Set cooking temperature

Touch key to confirm the cooking mode is "Ordinary steaming" (operation ③), the corresponding default temperature value is flashing, touch - or + key to set the required cooking temperature. For each touch, subtract 1 or add 1. Long press the touch to fast forward, as shown in the figure (operation ④). For example, set the cooking temperature to 203°F. Then, touch the to enter the cooking time setting interface (Operation ⑤)



4. Set cooking time

When entering the cooking time setting interface, the time value on the display interface starts to flash. At this time, touch the - or + key to set the required cooking time (in minutes). For example, set the cooking time to 30 minutes, as shown below (Operation ⑥).



5. Start cooking

After the time setting is completed, touch the key (Operation ⑦) and the steam oven starts cooking.

6. Finish cooking

After the set cooking time is reached, the steam oven automatically stops working, and the buzzer sounds for 10 times to remind the user to enter the mode selection interface, and the cooking ends.

Note: Since the steam oven has no cooling function, when the ambient temperature is higher than the set cooking temperature, the steam oven will not be able to cook according to the set temperature.

Preheat

In the cooking process, the oven needs a certain preheating time (preheating time is about 5-10 minutes according to the use environment and the set temperature). When the temperature in the steam oven reaches the set cooking temperature, the steam oven is preheated. At this point, the steam oven starts cooking and counts down according to the set cooking time.

★ SCD42-F1

I. Control Panel Diagram

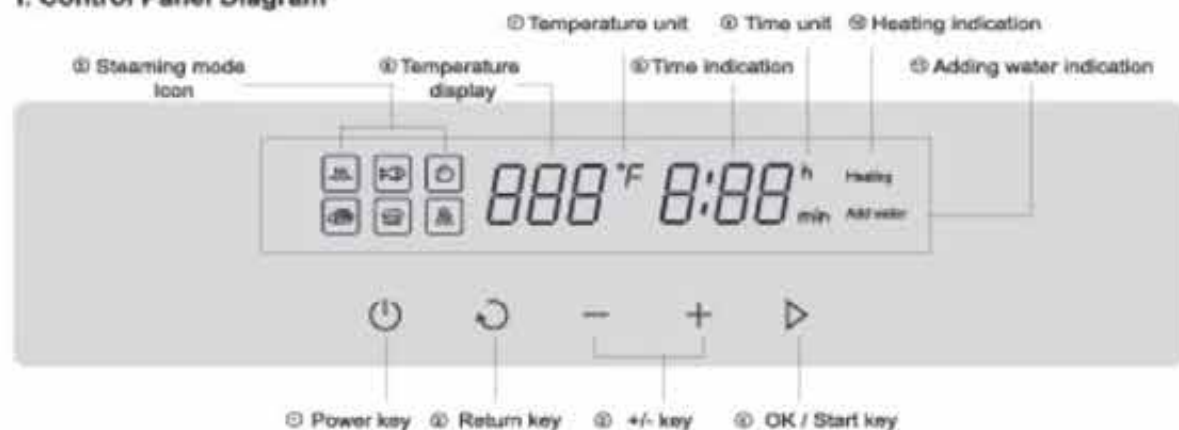

■ Description of the control panel, keys and display interface

● Operation keys

- ① Power Key: Touch this key to start the steam oven, and touch this key to turn off the steam oven when it is on.
- ② Return key: Touch this key to exit the existing interface, setting or function.
- ③ +/- key: Touch this key to set the value required for cooking temperature and time.
- ④ OK/Start key: Touch this key to confirm the set cooking temperature and time, and start cooking.

● Icons and text on the display interface

- ① Steaming Mode Icon: It is used to identify the available steam cooking modes. There are 6 kinds of available steam cooking modes: Ordinary steaming, steaming fish, steaming pasta, steaming meat, fermenting, descaling.
- ② Temperature display: It can display the temperature you set and the temperature inside the steam oven.
- ③ Temperature unit: This icon shows the temperature unit you set (°F).
- ④ Time indication: It can display the cooking time you set.
- ⑤ Time unit: It can display the time unit you are setting.
- ⑥ Heating indication: When the icon "heating" is constantly on, it indicates that the steam oven is in operation. When the door of steam oven is opened during operation, this icon flashes.
- ⑦ Adding water indication: When this icon flashes, it indicates you need to add water into the water tank of the steam oven, then push the tank into the tank slot and push it into place.

II. Precautions before use

■ Water tank filling

Before operation of the steam oven, firstly fill fresh water into the water tank to the highest water level mark of 'MAX', and then insert the water tank into the tank slot, and push it in place. (Please use pure water for cooking to avoid damage to the steam oven due to scale accumulation)

- Insert the oil pan (no holes) in the bottom layer of the tank before using the steaming pan (with holes).

■ Function list

Steaming mode icon	Steaming function	Default temperature(°F)	Default time (min)	Temperature range (°F)	Time range
	Ordinary steaming	212	20	86-212	1 minute - 5 hours
	Steaming fish	212	15	194-212	1 minute - 5 hours
	Steaming pasta	212	15	194-212	1 minute - 5 hours
	Steaming meat	212	30	194-212	1 minute - 5 hours
	Fermenting	95	30	95-113	1 minute - 9 hours 59 minutes
	Descaling	Fixed settings of program	Fixed settings of program	Fixed settings of program	Fixed settings of program

Note: The default temperature is for reference only. The cooking temperature can be selected according to the characteristics of the cooking ingredients: for example, in the "steaming fish" mode, the default temperature (212°F) is more appropriate when cooking salted or older fish, while when cooking fish with relatively tender meat, cooking temperature and cooking time shall be reduced appropriately.

III. Use Steam oven for Cooking

Operation steps: place the dishes in the steam oven → fill water in the tank → turn on the steam oven → select the cooking mode → set the cooking temperature → set the cooking time → confirm and start cooking → finish cooking and shut down → daily cleaning

1. Power on/off

Touch the 'Power' key to start the steam oven, then enter the standby interface; touch the 'Power' key in the power-on state to complete the power-off, and the display goes out at the same time.

2. Choose the cooking mode

When the standby interface is set, the required cooking mode is selected by touching the '+/-' key, for example, the 'Ordinary Steam' mode is selected, and all cooking mode icons are displayed on the display interface, in which the 'Ordinary Steam' icon flashes and displays the corresponding default temperature. The display interface at this time is shown in the following figure (Operation ①).

Note: The icon or text "Flash" mentioned in the manual is to remind you to set the corresponding item.



FOTILE 方太

使用说明书

请妥善保管，以备参阅

使用产品前请仔细阅读
本说明书

电 蒸 箱

SCD42-C2T/SCD42-F1

1107000404310

宁波方太厨具有限公司 NINGBO FOTILE KITCHENWARE CO.,LTD.

尊敬的用户，您好！感谢您选购方太公司为您精心制造的方太系列产品，使用前请通读本说明书，您将从中了解正确的操作规范，并享受到全新的下厨乐趣。

方太对您的承诺是“让家的感觉更好”，我们有责任使您对崭新的方太产品感到满意，请您在使用前务必认真阅读《使用说明书》，并遵从说明书要求进行使用，本说明书的操作说明对于维持产品的良好工作状态十分重要，若因使用不当造成产品故障，您将丧失免费保修的权利，任何直接或间接的免费保修申请将不被本公司售后服务中心所接受，同时我们建议您在质量保修期内及保修期后需要维修时请致电方太售后服务中心，这对您和我们都是非常重要的。如果没有好的服务，您等于只购买到一半的产品，方太更佳感觉星级服务宗旨就是“努力，让顾客完全满意”。我们的售后服务中心将为您提供宁波方太厨具有限公司纯正的零部件及专业的技术支持，使您的产品得到优质快捷的维修保障，同时让您得到轻松细心的服务。

目录

目录	1
产品结构介绍	2
安全注意事项	3
快速使用指南	7
高级进阶操作	14
装箱清单	18
安装方法	18
主要技术参数	20
电气接线图	20
清洁保养建议	20
常见问题处理	22

产品结构介绍

图例

★SCD42-C2T



- ① 控制面板
- ② 触摸按键
- ③ 显示屏
- ④ 整机安装柱
- ⑤ 蒸箱门
- ⑥ 水箱
- ⑦ 内胆温度传感器
- ⑧ 内胆底部发热盘
- ⑨ 橡胶门封

★SCD42-F1

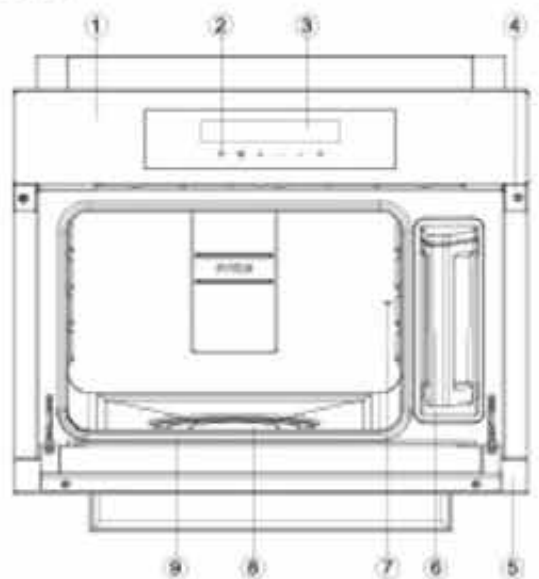

- ① 控制面板
- ② 触摸按键
- ③ 显示屏
- ④ 整机安装柱
- ⑤ 蒸箱门
- ⑥ 水箱
- ⑦ 内胆温度传感器
- ⑧ 内胆底部发热盘
- ⑨ 橡胶门封

随机附件



一个多孔式设计的蒸盘。



一个接油盘。

安全注意事项

为了避免对使用人员及其他人员造成危害及财产损失，特作如下区分及标志，以下均为有关安全的重要事项，敬请严格遵守，并在充分理解内容的基础上正确使用。

根据危害、损害程度进行的内容区分

- 危险** 若忽视这一标志，并进行错误操作，极有可能导致人员危险，重伤或引起火灾。
- 警告** 若忽视这一标志，并进行错误操作，有可能导致人员危险，重伤或引起火灾。
- 注意** 若忽视这一标志，并进行错误操作，有可能导致人员受伤或造成物品损害。
- 建议** 为了安全，正确地进行使用，希望予以了解的内容。

警告、禁止内容的图标



- 警告：**本公司产品上的钢化玻璃进行了品质监控，但玻璃的钢化机理决定存在极小概率的钢化玻璃自爆。
- 特别说明：**请严格按照本说明书规定使用，由于本产品不当使用造成的任何财产损失、人身损害，本公司不承担责任。

危险	
	请不要使用松动或接触不良的电源插座，否则易导致触电、短路、起火。
	如果电源软线损坏，为了避免危险，必须由制造商、其维修部或类似部门的专业人员更换。
	插座必须具有可靠的接地线，以确保安全，不得将接地线接于煤气管、自来水管、避雷针及电话线上。接地不良可能引发触电或者其他意外事故。
	非专业人员不得擅自拆机维修或更换零件。
	请使用纯净水进行烹饪，以免水垢积攒后损坏机器。
	如果蒸箱出现任何故障请立即断电停止使用，并按照‘常见故障识别与处理’进行相应处理。
	工作完毕后，请在30-60秒后打开蒸箱门，开门时有蒸汽喷出，人应站在离蒸箱门稍远处，以免蒸汽烫伤。
	请不要让儿童和行动不方便者自己使用，更不要放在幼儿可以触及到的地方使用，否则可能导致烫伤、触电和其它意外伤害。
	本产品仅供家庭日常使用，请不要用于商业用途或在其它特殊环境中使用。
	工作完毕后，内胆底部仍有较高温度，请勿立即清洁内胆以免烫伤，需要等内胆冷却后再清洁。

警告

 电蒸箱在使用期间会发热，注意避免接触蒸箱内的发热元器件。	 清洗时必须切断电源，注意使用中性和清洗剂，同时注意使用柔软抹布擦洗，防止划伤表面。
 整机远离热源，煤气和酒精等易燃品。	 请不要在手脚潮湿、赤脚的状态下触摸蒸箱。
 请不要将重物放在开启的蒸箱门上。	 请不要使用连接多个插头的多功能插座。
 拔出插座上的插头时，必须手握插头的端部将其拔出，请不要手拿电源线拔插头，否则易发生触电、短路、起火等危险。	 不要使用粗糙清洗剂或锋利的金属刮刀清洁蒸箱门的玻璃，因为它们会擦伤玻璃表面，从而导致玻璃破碎。
 在使用时可触及部分可能会发热，儿童应远离。	

注意

- 本产品仅供家庭烹饪使用，如作其他用途会有危险。未按照本说明书要求使用所造成的任何人身损害、财产损失，本公司不承担任何责任。
- 首次使用前清洁。首先取出水箱，用热水冲洗水箱内部，切勿使用任何清洁剂或清洁剂。内胆内部侧支架、随机附件亦可取出冲洗（请参阅[保养清洁]部分），建议使用经热水稀释的清洁剂清洁蒸箱内胆内壁。
- 为保持卫生，请在每次使用后把水箱里多余的水倒出，避免积累冷凝物在机内。
- 每次使用后，应用柔软抹布抹干冷凝水槽。
- 打开蒸箱门，让箱内的湿气散去，直至干透为止。
- 如将不使用本机一段时间（如度假），应先彻底清洁本机，随后打开蒸箱门，以免产生异味。
- 水箱在使用中每加一次水要用布抹干水箱卡槽底部积水。
- 蒸箱在不使用时，应先确认蒸箱处于关闭状态。
- 蒸箱出现功能不正常时，请拔掉电源重新上电，若仍有问题，请按照“常见故障识别与处理”进行相应处理。
- 为加强保护，拿烫手的器皿时，建议戴上隔热手套。避免手套湿水，否则热力很快传过手套，造成烫伤。

重要说明

- 正确安装——确保由合格技术人员正确安装本产品并接地。
- 严禁将本产品用于房间取暖或加热。
- 请看护好孩子——请勿将儿童单独留在使用本产品的区域。绝不能让儿童坐在或站在本产品的任何部位上。
- 穿着适当——使用本产品时，请勿穿宽松肥大的衣服。
- 用户检修——除产品说明书中的明确建议外，切勿自行修理或更换本产品的任何零部件，所有其他检修工作应交给合格技术人员处理。
- 产品内外存放物品——请勿在蒸箱内或其表面装置附近存放易燃物。
- 油脂着火时，请勿用水扑灭——将火或火焰闷熄，或使用干粉灭火器或泡沫灭火器。
- 仅使用干的隔热手套——使用潮湿的隔热手套接触高温表面可能会导致蒸汽烫伤。请勿用隔热手套触碰高温加热元件，勿使用毛巾或其他粗布块。
- 开门时请小心——取食物或更换食物前，先让热空气或热蒸汽散离。
- 请勿给未开启的食物容器加热——压力集聚可能会导致容器爆炸，造成人员伤害。
- 请勿堵塞蒸箱排气管。
- 蒸盘的放置——应始终在蒸箱冷却状态下把蒸盘放在预定位置。如果必须在蒸箱处于高温状态下移动烤架，请勿让隔热手套触碰蒸箱内的高温加热元件。

安装维修安全

- 首次使用本机前，请先阅读本操作说明书有关本机的安全使用、操作及护理的重要说明，从而避免意外及损坏。
- 在安装蒸箱前确保家庭所用电源的电压和频率与本机相符。
- 确定您的蒸箱由专业的安装服务人员完成，并且确定安装安全可靠并接地良好。为了保证蒸箱的用电安全，必须确保机器接地和家庭电网接地连接正确并可靠。这是一项基本的安全要求。如果家庭电网存在问题，并由此产生的伤害，本产品制造商不负任何责任。
- 安装、修理必须由方大专业的服务人员完成，请勿擅自安装、修理。
- 为保障安全和正确使用，本产品必须由本公司指派的专业人员进行安装和维修，如因消费者委托非本公司指派的人员或消费者自行安装和维修，而导致产品不能正常使用的，即使在保修期内，也不属于免费维修范围。
- 不能使用长距离的插线板来连接本产品，因为线缆过长，机器工作时容易引发电线过热而造成火灾或漏电事故。
- 禁止擅自打开本产品外壳，接触连接线、电气件或者结构件是危险的，有可能会触电或引起机械创伤。
- 电蒸箱安装后，如果不能触及电源插头，则应由符合布线规定的固定布线的开关完成，以满足维修或突发事件时，通过此开关切断电源。

使用安全

- 请确保本产品正确可靠地安装在橱柜中后再进行操作。
- 本产品仅限于家庭烹饪，而不能用于任何商业目的烹饪。其他任何应用也会存在安全风险，并有可能造成人身伤害。
- 不能将电源插头、电线等浸入水中，以免再次使用时发生触电危险。
- 从卫生考虑，每次使用完毕后请将水箱中的水倒干擦净，避免产生水垢。
- 使用完毕并冷却后，用干净的布擦干内胆、门体内侧和冷凝水槽。
- 如果打算长时间不再使用，则应将蒸箱彻底清洁，避免气味产生。详见[保养清洁]部分。

对于儿童安全

- 在使用中，有蒸汽通过出风口溢出，即便在停止使用后，门的内外都会有点温度，所以请您的孩子与本产品保持一个安全距离，并予嘱咐。
- 在蒸箱工作时，有必要照着产品附近孩子。
- 不允许您的孩子靠着或悬挂在蒸箱的门体上。
- 为减少伤害您孩子的风险，请不要让您的孩子将蒸箱作为游戏的道具，也不要让您的孩子在蒸箱附近玩耍。
- 确保塑料袋放在您孩子够不到的地方保存，防止孩子玩耍时窒息。

产品安全

- 不要加热盛于密闭容器的食物。在加热下会增加容器内压力，可能会引起爆炸，使机器受到损伤，同时人体也会受到伤害。
- 在每次使用后，请及时清洗并擦干机器，因为冷凝后的浓缩物在长时间下可能会对机器产生腐蚀作用。
- 不要使用使蒸箱生锈的物体，这样会损伤您的蒸箱。
- 在除锈时，尽量采用柠檬酸除锈剂，使用其他除锈剂可能会损害您的蒸箱。
- 不要用蒸汽清洁器来清洗您的蒸箱，蒸汽会渗透到电子元器件，造成短路而使机器无法正常工作，甚至导致触电。
- 如果发生异常情况，请关掉提供蒸箱电源的闸刀，立即联系方太公司服务部门来人处理。在未处理前请远离机器，不要靠近。
- 维修、安装等相关工作必须由方太专业的服务人员操作。

人员安全

- 蒸箱必须安装安全合适的高度，方便在烹饪时开关门体并取放食物。否则溢出的蒸汽可能会烫伤您。另外合适的安装高度将降低您的孩子将手放在门体上烫伤的风险。
- 开门时，小心门体的铰链、边沿及角落，请勿触摸，避免产生机械创伤。
- 在观察或拿取食物时，先微微开启门体，让大量蒸汽溢出，然后再打开门体，避免手或身体部位直接接触蒸汽，防止烫伤。
- 在开门时，请注意冷凝水槽中的水溅落。
- 在烹饪食物时，请小心操作，不要将食物的容器倒倾而使积液流出或食物流出。
- 在取放热的容器时，请用厚布包裹后取放，避免烫伤您的手。
- 在丢弃或移动您的蒸箱时，请先拔下蒸箱的电源插头。

快速使用指南

★SCD42-C2T

一、控制面板图

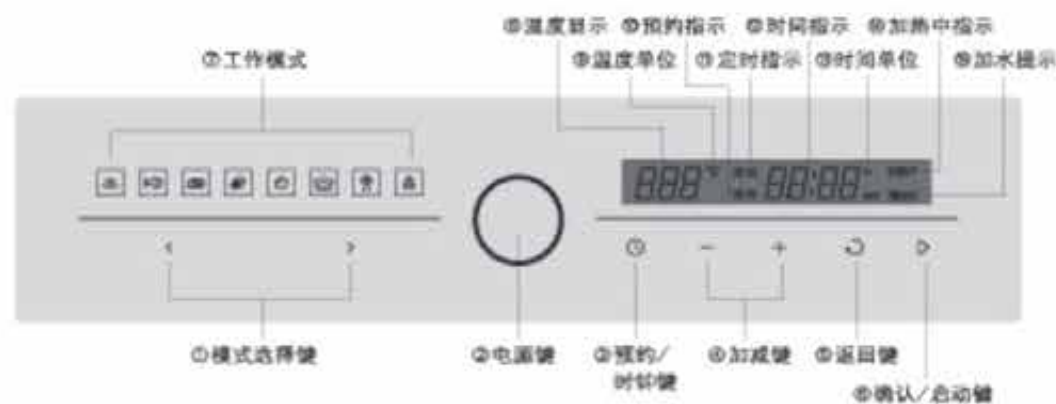

■ 关于控制面板、按键及显示界面的说明

● 操作按键

- ① 模式选择键：触摸此键可循环选择工作模式。
- ② 电源键：触摸此键可开机，开机状态下触摸此键可关机。
- ③ 预约/时钟键：触摸此键可以设置时钟和预约烹饪时间。（参见章节：时钟设置、使用预约功能进行烹饪）
- ④ 加减键：触摸加减键可设置烹饪温度、烹饪时间或时钟时间所需的数值。
- ⑤ 返回键：设置过程中，触摸此键返回至上一设置界面，工作中，触摸此键返回至模式选择界面。
- ⑥ 确认/启动键：触摸此键可以确认设置的烹饪温度、时间以及启动烹饪。

● 显示界面的图标和文字等

- ① 工作模式：工作模式图标用于标识可用的蒸汽工作模式，工作模式有8种可选模式：普通蒸、蒸鱼、蒸肉、蒸蔬菜、蒸面食、发酵、解冻、除垢。
- ② 温度显示：可显示您设定的温度以及箱体内的实时温度。
- ③ 温度单位：此图标显示您设置的温度单位(°F)。
- ④ 预约指示：此图标标识您选择了预约模式进行烹饪。
- ⑤ 定时指示：此图标显示表示您正在设置或者已经设定好了烹饪时间。
- ⑥ 时间指示：可显示您设定的烹饪定时时间以及预约倒计时时间。
- ⑦ 时间单位：显示您正在设置的时间的单位。
- ⑧ 加热中指示：图标“加热中”常亮时，表示您的蒸箱正在烹饪工作中，工作中打开门时，此图标闪烁。
- ⑨ 加水提示：此图标闪烁时，表示需要您为您的蒸箱水箱加水，然后将水箱推入水箱卡槽中，并且推到位。









二、每一次使用前注意事项

■ 水箱注水

蒸箱工作前，首先往水箱里注入饮用淡水至“MAX”最高水位刻度线处，然后将水箱插入水箱卡槽中，并且推到位。（最好采用纯净水）。

■ 在使用蒸盘（有孔）前请在内胆中的底层插入接油盘（无孔）。

■ 功能一览表



蒸模式图标	蒸功能	默认温度(°F)	默认时间(min)	温度范围(°F)	时间范围
	普通蒸	212	20	86-212	1分钟 - 5小时
	蒸鱼	212	15	194-212	1分钟 - 5小时
	蒸肉	212	30	194-212	1分钟 - 5小时
	蒸蔬菜	212	20	194-212	1分钟 - 5小时
	蒸面食	212	15	194-212	1分钟 - 5小时
	发酵	95	30	95-113	1分钟 - 12小时
	解冻	122	30	104-122	1分钟 - 5小时
	除垢	程序固定设置	程序固定设置	程序固定设置	程序固定设置

注：默认温度仅作参考，可根据烹饪原料的特点，选择合适的烹饪温度。例如，“蒸鱼”模式，默认温度（212°F）在烹饪腌制或肉质较老的鱼类时较为合适，而烹饪肉质相对细嫩的鱼时，应当降低烹饪温度以及缩短烹饪时间。详细烹饪方法可参考随本机赠送的蒸箱菜谱。





三、使用蒸箱进行烹饪

操作步骤：放置菜肴于箱体内→水箱注水→开机→选择烹饪模式→设定烹饪温度→设定烹饪时间→确认并开始烹饪→烹饪结束并关机→日常清洁

1. 开机\关机

触摸“电源”键  即可开机（操作①），随即进入模式选择界面；在开机状态以及任何工作模式下触摸“电源”键  即完成关机，显示屏熄灭。



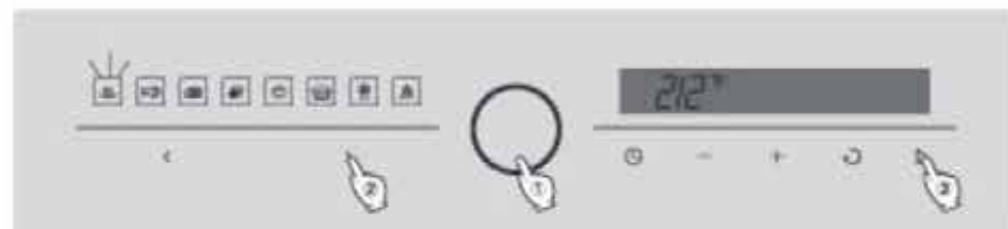

2. 选择烹饪模式

在模式选择界面时，显示屏显示所有工作模式图标且第一个模式图标  闪烁，此时触摸 、 键可进行模式的循环选择。触摸  键向左选择，触摸  键向右选择（操作②）。例如选择了“普通蒸”模式，界面显示的烹饪模式图标中，仅有“普通蒸”图标在闪烁，此时的显示界面如下图。

注：说明书中提到的图标或文字“闪烁”，即为提醒您对该项进行设置。





3. 设置烹饪温度

触摸  键，就确定了烹饪模式为“普通蒸”（操作③）；此时对应的默认温度值在闪烁，触摸  或  键设置需要的烹饪温度，每触摸一下相应减1或加1，长按触摸以快速的方式进行。如图所示（操作④），例如设置烹饪温度为203°F。设置好烹饪温度后，触摸  键进入烹饪时间设置界面（操作⑤）。



4. 设置烹饪时间

进入烹饪时间设置界面时，显示界面上的时间数值开始闪烁，此时触摸  或  键设置所需要的烹饪时间（单位为分钟），例如设置烹饪时间为30分钟，如下图所示（操作⑥）。



5. 开始烹饪

时间设置完成后，触摸  键（操作⑦），此时蒸箱开始烹饪。

6. 烹饪结束

到达设置的烹饪时间后，蒸箱自动停止工作，蜂鸣器短鸣10次进行提醒后进入模式选择界面，烹饪结束。

注：由于蒸箱无制冷功能，当环境温度高于设置的烹饪温度时，蒸箱将无法按照设置的温度进行烹饪。

■ 预热

烹饪过程中，蒸箱需要一定的预热时间（预热时间根据使用环境以及设定的温度不同大约为5-10分钟），当箱体内温度达到设定的烹饪温度时蒸箱即完成预热，此时蒸箱开始烹饪并按照设定的烹饪时间进行倒计时。

四、产品展示\功能设置的说明

■ 接通电源

蒸箱接通电源后，发出一声蜂鸣声，进入时钟设置界面。接通电源2分钟内无操作，则进入数字时钟待机界面。数字时钟界面显示40秒后进入关机界面。

■ 时钟设置

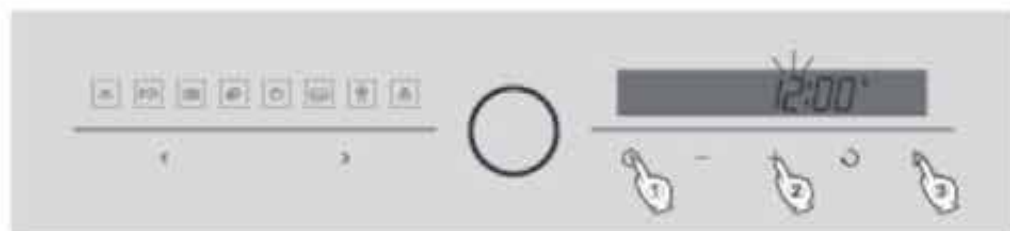

在模式选择界面，触摸  键可进入时钟设置界面（操作①）。此时时间数值闪烁，如下图所示。



通过触摸  键或  键设置时间数值（小时）（操作②）。

先设置小时，再设置分钟；设置好小时值后，触摸  键进入分钟值设置（操作③）。



通过触摸  键或  键设置时间数值（分钟）（操作④）。时钟设置完毕后触摸  键完成时钟设置（操作⑤），此时界面返回至模式选择界面。

■ 模式选择界面

触摸“电源”键  即可开机。随即进入模式选择界面。

注：在未开机状态时，只有“电源”键  有效。

模式选择界面如下图所示。其中第一个模式图标在闪烁。



注：模式选择界面时，若2分钟内无操作，则进入关机界面。



数字时钟待机界面







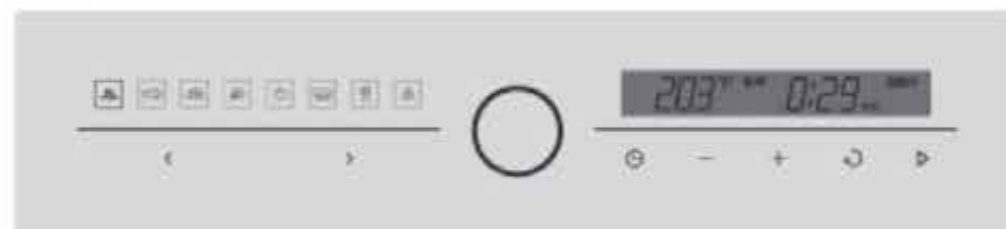

关机界面

■ 烹饪工作界面



预热过程中，“时间显示”显示的时间为设定的烹饪时间，“温度显示”显示的温度为箱体内的实时温度。当箱体内实际温度达到设定温度，即完成预热。此时“时间显示”显示的时间为烹饪倒计时，“温度显示”为设定温度。

■ 其他七个功能的设置

其它七个功能的设置：蒸鱼 、蒸肉 、蒸蔬菜 、蒸面食 、发酵 、解冻  的设置与普通蒸模式一样。

由于不同食材对烹饪温度、不同时间段的火力有不同的要求，故为了达到更好的烹饪效果，建议根据菜肴的主要食材材质选择恰当的烹饪模式。

★SCD42-F1

一、控制面板图



■ 关于控制面板、按键及显示界面的说明

● 操作按键

- ① 电源键：触摸此键可开机，开机状态触摸此键可关机。
- ② 返回键：触摸此键退出现有界面、设置或功能。
- ③ 加减键：触摸加减键可设置烹饪温度、烹饪时间所需的数值。
- ④ 确认/启动键：触摸此键可以确认设置的烹饪温度、时间以及启动烹饪。

● 显示界面的图标和文字等

- ⑤ 蒸模式图标：蒸模式图标用于标识可用的蒸汽烹饪模式。蒸汽烹饪模式有6种可选模式：普通蒸、蒸鱼、蒸面食、蒸肉、发酵、解冻。
- ⑥ 温度显示：可显示您设定的温度以及箱体内的温度。
- ⑦ 温度单位：此图标显示您设置的温度单位（°F）。

- ④ 时间指示：可显示您设定的烹饪定时时间以及预约倒计时时间。
- ⑤ 时间单位：显示您正在设置的时间的单位。
- ⑥ 加热中指示：图标“加热中”常亮时，表示您的蒸箱正在烹饪工作中，工作中打开门时，此图标闪烁。
- ⑦ 加水提示：此图标闪烁时，表示需要您为您的蒸箱水箱加水，然后将水箱推入水箱卡槽中，并且推到位。

二、每一次使用前注意事项

■ 水箱注水

蒸箱工作前，首先往水箱里注入饮用淡水至“MAX”最高水位刻度线处，然后将水箱插入水箱卡槽中，并且推到位。（请使用纯净水进行烹饪，以免水垢积攒后损坏机器。）

■ 在使用蒸盘（有孔）前请在内胆中的底层插入接油盘（无孔）。

■ 功能一览表

蒸模式图标	蒸功能	默认温度(°F)	默认时间(min)	温度范围(°F)	时间范围
	普通蒸	212	20	86-212	1分钟-5小时
	蒸鱼	212	15	194-212	1分钟-5小时
	蒸面食	212	15	194-212	1分钟-5小时
	蒸肉	212	30	194-212	1分钟-5小时
	发酵	95	30	95-113	1分钟-9小时59分钟
	除垢	程序固定设置	程序固定设置	程序固定设置	程序固定设置

注：默认温度仅作参考，可根据烹饪原料的特点，选择合适的烹饪温度。例如，“蒸鱼”模式，默认温度（212°F）在烹饪腌制或肉质较老的鱼类时较为合适，而烹饪肉质相对细嫩的鱼时，应当降低烹饪温度以及缩短烹饪时间。

三、使用蒸箱进行烹饪

操作步骤：放置菜肴于箱体内→水箱注水→开机→选择烹饪模式→设定烹饪温度→设定烹饪时间→确认并开始烹饪→烹饪结束并关机→日常清洁

1. 开机\关机

触摸“电源”键即可开机，随即进入待机界面；在开机状态下触摸“电源”键即完成关机，显示屏同时熄灭。

2. 选择烹饪模式

待机界面时，通过触摸“加减”键选择所需的烹饪模式。例如选择了“普通蒸”模式，此时显示屏显示所有的烹饪模式图标，其中“普通蒸”图标闪烁，同时显示对应的默认温度，此时的显示屏界面如下图（操作①）。

注：说明书中提到的图标或者文字“闪烁”，即为提醒您对该项进行设置。



3. 设置烹饪温度

触摸“确认/启动”键，就确定了烹饪模式为“普通蒸”（操作①），此时默认温度值在闪烁，触摸“加减”键可设置所需的烹饪温度，如下图所示（操作②），例如设置烹饪温度为212°F，设置好烹饪温度后，触摸“确认/启动”键进入时间设置界面（操作③）。

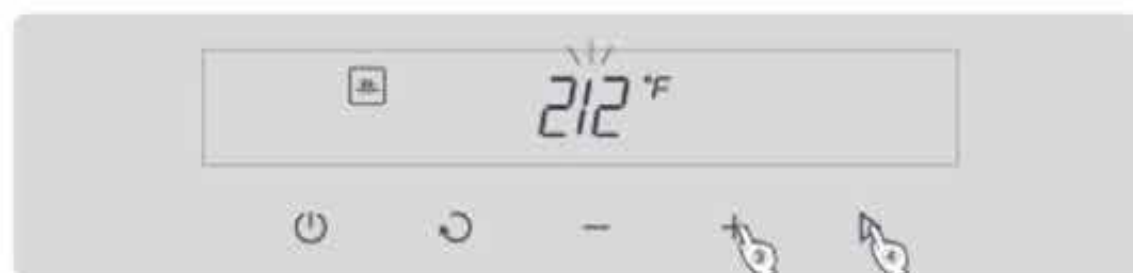

4. 设置烹饪时间

进入烹饪时间设置界面时，显示界面上的时间数值开始闪烁，此时通过触摸“加减”键设置所需要的烹饪时间（单位为分钟），例如设置烹饪时间为1小时30分钟，如下图所示（操作⑤）。



5. 开始烹饪

温度设置完成后，触摸“确认/启动”键（操作⑤），此时蒸箱开始进行烹饪。

6. 烹饪结束

到达设置的烹饪时间后，蒸箱自动停止工作，蜂鸣器短鸣10次进行提醒后进入模式选择界面，烹饪结束。

注：由于蒸箱无制冷功能，当环境温度高于设置的烹饪温度时，蒸箱将无法按照设置的温度进行烹饪。

■ 预热

烹饪过程中，蒸箱需要一定的预热时间（预热时间根据使用环境以及设定的温度不同大约为5-10分钟），当箱体内温度达到设定的烹饪温度时蒸箱即完成预热，此时蒸箱开始烹饪并按照设定的烹饪时间进行倒计时。

高级进阶操作

★SCD42-C2T

一、除垢功能设置

由于蒸箱工作一段时间后，内胆底部加热盘可能出现水垢，为了提高其工作效率以及延长使用寿命，用户可选择 除垢程序进行除垢。

“除垢”功能的基本操作流程：

- 将一包专用水垢清除剂加入水箱中，加温水至水箱刻度线的“除垢水位”，充分搅拌直至完全溶解。
- 将水箱放入水箱卡槽中，在模式选择界面下，触摸 <、> 键选择“除垢”功能图标 除垢，触摸 ▷ 键开始除垢，除垢过程中的显示界面如下图所示：



- 除垢完成后，蒸箱自动停止工作，蜂鸣器短鸣10次后进入模式选择界面，除垢结束，除垢结束后请倒掉水箱中剩余的水并清洁蒸箱腔体和水箱。

注：除垢工作状态下，温度和定时时间不可选择，均为程序固定设置。

二、使用预约功能进行烹饪

操作步骤：水箱注水→放置菜肴于箱体内→开机→选择烹饪模式→设置烹饪温度→设置烹饪时间→设置预约烹饪时间→确认，完成预约设置→等待到达设置的预约时间后开始烹饪→烹饪进行中→烹饪结束并自动关机→清洁

以上前6个操作步骤，即到“设置烹饪时间”这一操作时，与【使用蒸箱进行烹饪】完全相同，以下从“设置预约烹饪时间”开始介绍。

1. 设置预约烹饪时间

设置好烹饪时间后，不触摸 ▷ 键，且在2分钟内触摸 ⊖ 键进入预约烹饪时间的设置（操作①）。此时时间数值闪烁，如下图所示。



通过触摸 ⊖ 键或 ⊕ 键设置需要预约的时间（小时）（操作②）。

先设置小时，再设置分钟；设置好小时值后，触摸 ▷ 键进入分钟值设置（操作③）。



2. 完成预约设置

通过触摸 ⊖ 键或 ⊕ 键设置时间数值（分钟）（操作④），时间设置完毕后触摸 ▷ 键完成（操作⑤），如下图所示，此时界面显示预约开始烹饪的时间。如不触摸 ▷ 键确认，2分钟后进入时钟界面。



3. 开始烹饪

等待到达设置的预约烹饪时间后蒸箱自动开始烹饪，待蒸箱工作到达设置的烹饪温度后，显示烹饪倒计时。

4. 烹饪结束

到达设置的烹饪时间后，蒸箱自动停止工作，蜂鸣器短鸣10次进行提醒后进入模式选择界面，烹饪结束。

三、其他附加功能

功能名称	功能内容
修改烹饪温度、烹饪时间功能	在整机工作时，触摸 ⊖ 键或 ⊕ 键可重新设置烹饪温度，然后触摸 ▷ 键确认，烹饪温度设置完成后再触摸 ⊖ 键或 ⊕ 键可重新设置烹饪时间，再触摸 ▷ 键确认。
修改预约的时间功能	在预约等待时，触摸 ⊖ 键进入预约时间修改，再触摸 ⊖ 键或 ⊕ 键修改预约时间，然后触摸 ▷ 键确认。如不触摸 ▷ 键确认，则新设置的预约时间无效，整机工作过程中预约设置或修改无效。
风扇降温功能	在蒸箱定时工作结束后，风扇会再持续运转20分钟。
缺水提示功能	当水箱内的水低于最低水位后，显示屏上的“请加水”闪烁，并每隔30秒蜂鸣器提示三声，此时请取出水箱并注入常温饮用纯净水至“MAX”最高水位线处，然后将水箱推入水箱卡槽中，并且推到位（请使用纯净水进行烹饪，以免水垢积攒后损坏蒸箱）。

★SCD42-F1

一、产品显示\功能设置的说明

■ 接通电源

蒸箱接通电源后，显示屏全部显示后显示屏关闭，蜂鸣器蜂鸣一声后并进入关机状态。
关机状态：显示屏无任何显示。

■ 待机界面

触摸“电源”键，即可开机，随即进入待机界面。
注：在未开机状态时，只有“电源”键有效。
待机状态时，显示界面如下图所示



待机状态

注：待机界面时，若2分钟无操作，则蒸箱关机。

注：设置状态下，2分钟内无任何操作则蒸箱进入待机状态。

■ 烹饪工作界面



预热过程中，“时钟显示”显示的时间为设定的烹饪时间，“温度显示”显示的温度为箱体内的实时温度；当箱体内实际温度达到设定温度，即完成预热时，“时钟显示”显示的时间为烹饪倒计时，温度显示为实时温度。

■ 除垢功能设置

由于蒸箱在工作一段时间后，内胆底部发热盘可能会出现水垢，为了提高其工作效率以及延长使用寿命，用户可选择“鱼”除垢程序进行除垢。

除垢功能的基本操作流程：

- 将适量的专用水垢清除剂加入水箱中，加温水至水箱刻度线的“除垢水位”，直到水垢清除剂充分溶解；
- 将水箱放入水箱卡槽中，在模式选择界面下，触摸“加减”键选中“除垢”功能图标“鱼”，触摸“确认/启动”键开始除垢，除垢过程中的显示界面如下图所示；



- 除垢完成后，蒸箱自动停止工作，蜂鸣器短鸣10次后进入模式选择界面，除垢结束，除垢结束后请倒掉水箱中剩余的水并清洁蒸箱腔体和水箱。

注：除垢工作状态下，温度和定时时间不可选择，为默认的设置。

二、其他附加功能

功能名称	功能内容
修改烹饪温度、烹饪时间功能	在整机工作时，可触摸“加减”键来重新设置烹饪温度，然后触摸“确认/启动”键确认，烹饪温度设置完成后再触摸“加减”键可重新设置烹饪时间，再触摸“确认/启动”键确认。
风扇降温功能	在蒸箱定时工作结束后，风扇会再持续运转20分钟。
缺水提示功能	当水箱内的水低于最低水位后，显示屏上的“请加水”闪烁，并每隔30秒蜂鸣器提示三声，此时取出水箱并注入常温饮用纯净水至“MAX”最高水位线处，然后将水箱推入水箱卡槽中，并且推到位（请用纯净水进行烹饪，以免水垢积累后损坏蒸箱）。

装箱清单

请您开箱后逐一检查以下产品和附件是否齐全。

- 属于本公司或销售商责任的，请与销售商联系处理。
- 属用户自行责任的，请致电附近的售后服务中心。

■ 整机	1台	■ 水箱密封胶	2个
■ 使用说明书	1份	■ 木螺钉	2枚
■ 接油盘	1个	■ 蒸盘	1个

安装方法

- 电蒸箱应平稳安装在操作、保养方便且牢固的地方，不得倾斜安装。
- 严禁将电蒸箱及电源插座安装在可能受潮或容易被水淋湿的地方。
- 搬运放置时应从拉手孔或底部抬起，轻搬轻放，切不可通过拖拉门体或把手来移动电蒸箱。
- 本电蒸箱是嵌入在橱柜内的，橱柜孔的底板必须能承受132.3lbs以上的重量。

注意：1. 安装蒸箱的橱柜材料(木材和粘合剂)必须耐温212°F以上。

2. 为保持通风，请保持后部有大于1¹³/₁₆英寸的空隙。
3. 安装时必须在蒸箱前留有3¹/₂英寸以上的空间。
4. 用附件袋内的木螺钉将蒸箱固定在橱柜上(见打螺钉示意图)。
5. 本机需单独使用10A插座，且确定插座接触良好，请勿与其他电器共用。
6. 安装后，蒸箱面板左右边及上边应与周边墙壁、橱柜、器具等保持¹/₈英寸以上间隙，蒸箱面板下边应与周边墙壁、橱柜、器具等保持⁷/₁₆英寸以上间隙。
7. 蒸箱在出厂前会进行全检老化测试，因此在内部管路中会有少量的余水残留，在内胆和水箱中有少量水珠是正常现象。

去除蒸箱的外包装和薄膜袋，将蒸箱放置在离安装孔较近的地方，电源线一端插入蒸箱中背部电源线插座，另外一端接上电源插座(不带电)。一手提在蒸箱的挖手处，一手托住底部，将蒸箱慢慢地放在橱柜孔内，一手放开，轻轻地 将蒸箱推至尽头，将蒸箱的前端搁在橱柜底板上，用附件袋内的木螺钉将蒸箱固定在橱柜上(见打螺钉示意图)。

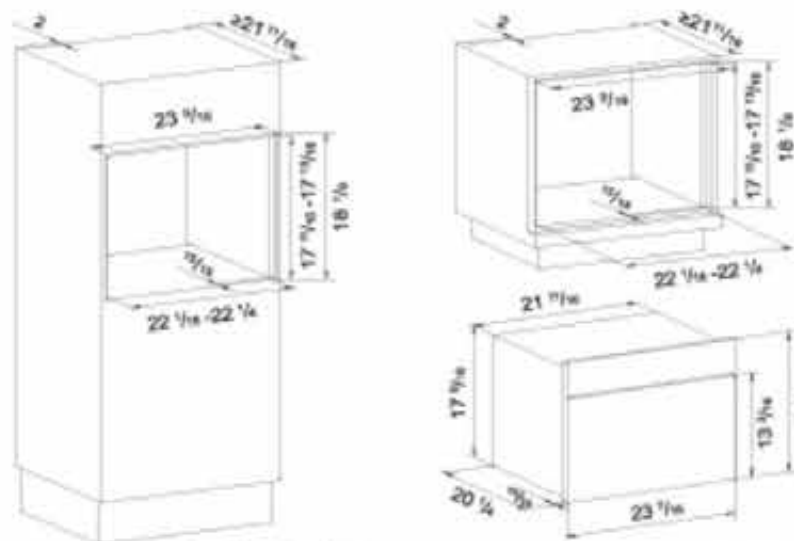

全嵌安装示意图

标注单位：英寸 (inch)

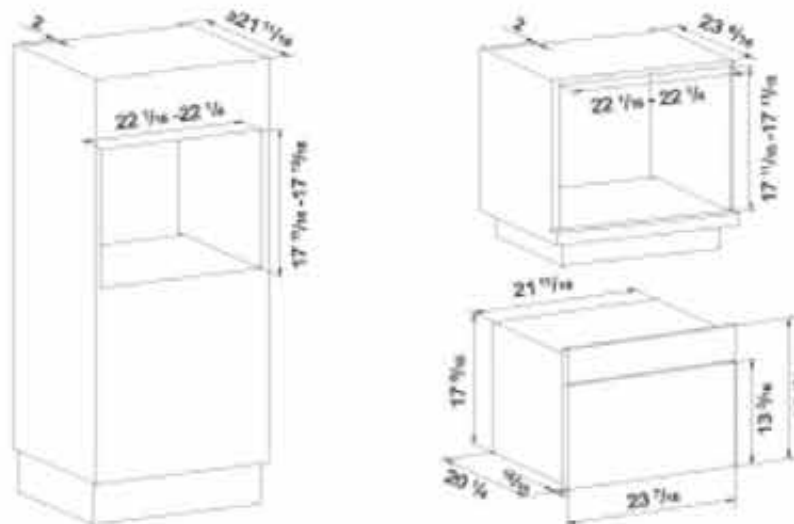

半嵌安装示意图

标注单位：英寸 (inch)

打螺钉示意图

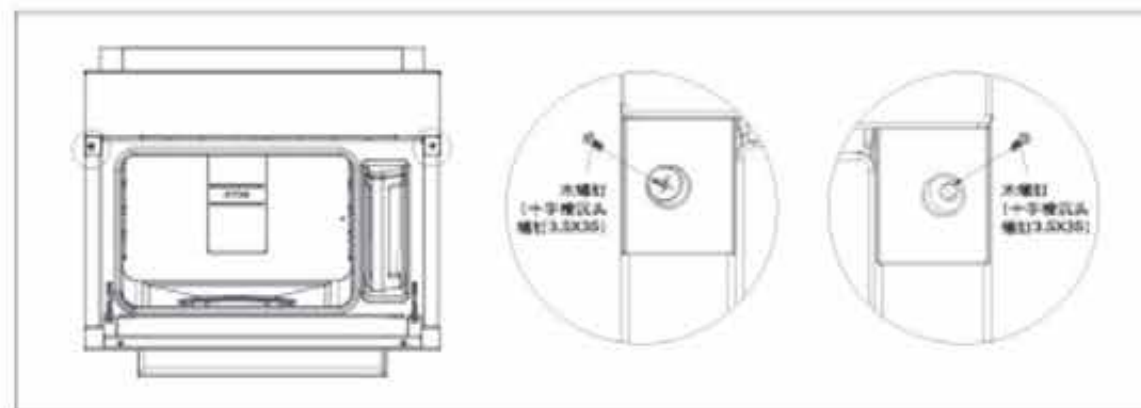

主要技术参数

机型	SCD42-C2T/ SCD42- F1		
额定电压	240V	净重	53.6 lbs
额定功率	2400W	加热方式	蒸汽加热
额定频率	60Hz	控制方式	触摸
额定容量	1.48Cu.Fl.		

电气接线图

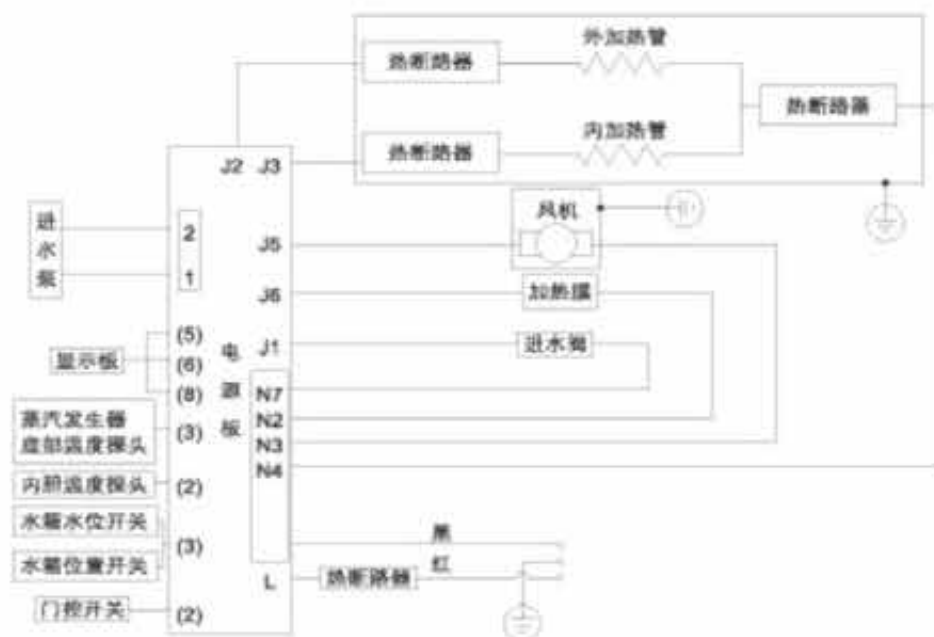

清洁保养建议

一般注意事项

每次使用后，需清洁内胆和冷凝水槽，清洁时待内胆冷却后才能进行。关上蒸箱门时，确保内胆已完全干透。

警告：切勿使用蒸汽清洁器清洁本机，加压蒸汽会对表面和配件造成永久损害。对此本公司概不负责。切勿使用含碱/苏打、酸或氯的清洁剂，亦不要使用清洁喷雾、洗碗碟机清洁剂或腐蚀性清洁剂。硬刷、百洁布及钢丝刷等。沾有磨蚀性清洁剂的海绵亦不要使用，以免刮花表面。

封边/蒸箱门封边

每次使用后，请清洁及抹干蒸箱门封边。请使用布海绵，再加上热水。不要使用清洁剂。蒸箱门封边可能会因日久而穿孔或裂开。如出现此情形，请更换新的封边。

警告：不要使用含表面活性剂的清洁剂，请确定没有清洁剂粘在蒸箱门封边。

蒸箱面板和外壳

蒸箱的面板，蒸箱门体及外壳可以用热水加少量的清洁液进行清洁，用布拭抹，清洁后用软布抹干。面板丝印区域容易划花和受酸性物质侵蚀，因此请按上述要求小心清洁。尽量不要使用不锈钢清洁剂和除垢剂，如使用，则应尽快抹除污渍，避免残留污渍损害您的蒸箱表面。

不锈钢面板及/或外壳：

建议使用不磨蚀清洁剂及护理剂。请沿着“钢纹”方向拭抹。力度要均匀。

蒸盘、接油盘及烹饪容器

每次使用蒸盘、接油盘及烹饪容器后，都要洗净和抹干。

注意：以上附件可放入洗碗碟机清洗。

蒸箱内壁

每次使用后，请清洁蒸箱内部。使用海绵或吸湿力强的软布抹去内胆内壁的凝结物。

大部分烹调残留物都可用布及温和清洁剂加热水清洁。在水质较差的地区，蒸箱内壁可能会有一层白色的沉积物，可用湿布和少量醋抹掉，用清水抹净内壁并抹干，同时清洁及抹干蒸箱顶部、凝结凹槽、箱门内壁及放置水箱的水箱卡槽。

建议：1. 同时清洁及抹干蒸箱顶部、内胆底部发热盘、箱门内壁及放置水箱的水箱卡槽。

2. 每次使用后，请将水箱中的水倒净并擦干水箱。

水箱

每次使用后请将水箱中的水倒出并晾干。

水箱接口密封圈为易损件，多次使用后，可能会出现磨损严重及破损情况，若出现此类情况进而影响水箱与水箱支座之间的密封效果时，可自行更换水箱接口密封圈(随整机赠送2个)。注意更换后检查安装是否到位。



水箱接口密封圈安装后

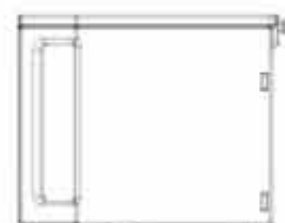

水箱接口密封圈安装前

内胆底部发热盘

每次使用后请将内胆底部发热盘中的水抹干。

蒸箱工作一段时间后，内胆底部发热盘难免会产生污垢。为了提高其工作效率及延长使用寿命，请使用食品级除垢剂进行除垢，具体操作详见“除垢功能设置”。

警告：因蒸箱使用后内胆底部发热盘会有较高温度，清洁工作要等内胆底部发热盘温度降低到合适温度再进行。

注意：为保持卫生，每次使用蒸箱后，请将水箱、内胆内壁及内胆底部发热盘中的水抹干，避免积累凝结物，请勿使用百洁布及钢丝刷等清洁。