



FOTILE
A BREATH OF FRESH ENGINEERING®

2-IN-1 IN-SINK DISHWASHER

SD2F-P3/SD2F-P3L

Use and Care Manual P2-P17

LAVAVAJILLAS DE LAVAPLATOS 2 EN 1

SD2F-P3/SD2F-P3L

Uso y Cuidado P20-P37

创新二合一 水槽洗碗机

SD2F-P3/SD2F-P3L

使用与保养说明 P40-P53

THANK YOU FOR MAKING FOTILE A PART OF YOUR HOME

Dear Customer,

Thank you for choosing the FOTILE In-Sink Dishwasher. Please read the Use and Care Manual carefully before using your new Sink Dishwasher. Please also retain this manual for further reference.

If you have any questions during your initial use, please call the FOTILE Service hotline at 1-884-315-0315 .

FOTILE
Happiness Starts In Your Kitchen!

Table of Contents

Safety Instructions	2
Main Technical Specifications	6
Operation Guidance	7
Tableware Placement	10
Washable Tableware/Material	11
Daily Cleaning	12
Maintenance Recommendations	13
Troubleshooting	14
Customer Service	15
Exploded View	16

Safety Instructions

To avoid injury and property damage to users and others, we have categorized the safety instructions and assigned symbols as shown in the table below.



Please review all the instructions carefully, and strictly observe each one of them. Failure to do so can result in personal injury or product damage.

This appliance is not intended for use by people (including children) with reduced physical, sensory, or mental capabilities, or lack of experience and knowledge.







Please keep children away from an unattended appliance.

If the Power Cord becomes damaged, it must be replaced by the manufacturer. Please call FOTILE Customer Service to schedule a Service Visit.

Categories by Degree of Damage or Injury

 DANGER	Ignoring this symbol and operating incorrectly can cause danger, serious injuries or fire.
 WARNING	Ignoring this symbol and operating incorrectly can cause danger, serious injuries or fire.
 CAUTION	Ignoring this symbol and operating incorrectly can cause injuries or property damage.











Icons for Caution and Prohibition





 Risk of Scalds	 Risk of Electric Shock	 Mandatory Action	 Grounding	 No	 No Open Flames	 No Touching	 Do not Operate with Wet Hands	 Do not Disassemble
--	--	--	---	--	--	--	---	--

 **CAUTION:** The tempered glass on FOTILE product has a minimal probability of spontaneous glass breakage due to its reinforcing mechanism. For spontaneous glass breakage not caused by improper usage, our company promises to change this accessory free of charge.









If there are any conflicts between terms in this operation manual and national laws and regulations, the national laws and regulations shall govern.

* **Special notes:** Please use this product by strictly following the instructions in this operation manual. The company is not responsible for any property damage or bodily injuries caused by improper usage of this product.

















 DANGER	
 No	Do not get the power cord, or any electric parts wet as this may cause electric shock or other accidental damages.
 No	Do not modify, stretch, knot or place heavy objects on the power cord. Doing so may cause damage to the power cord and result in electric shock, fire, and personal / property damage.
 No	Do not leave children unattended when using this product as this could cause electric shock or other accidental damages.
 Do not Operate with Wet Hands	Do not touch the power plug, connector or electrical parts with wet hands, this may cause electric shock.
 Risk of Electric Shock	Before installation and repair, please disconnect the power cord to avoid electric shock.
 No	Do not use flammable solvents such as alcohol to clean the sink..
 Mandatory Action	When moving the unit, please pay attention to the edges and corners of the sink to avoid scratches or injury.
 Risk of Scalds	During operation of this product, do not forcibly open the door, as you can be scalded by hot water and cause personal injury.
 Grounding	The electrical socket used with this appliance, must have reliable grounding to ensure safety. The grounding wire shall not be connected to a gas pipe, water pipe, lightning rod, or telephone line. Poor grounding may cause electric shock, personal injury, or property damage.

 WARNING	
 No	Do not use power sockets with loose or poor contact, this may cause electric shock, short circuit or fire. Ensure secure connection of the power cord, or it may cause electric shock.
 Mandatory Action	To avoid personal injury, property damage or product damage, this product is not intended for use by children, people with reduced mobility, or reduced sensory judgement unless supervised by a responsible individual.
 No	Do not forcibly close the functional sink door when it is automatically opened; otherwise the door may be damaged.
 No	Do not fill hot water into the inlet pipe directly, or it may affect the normal use of the product.

⚠ WARNING

 Do not touch heating units when in use, as it may cause scalds.	 If water leaks during operation, please stop using and contact FOTILE after-sales service center immediately at 1-888-315-0366.
 Disassembly of the product for repair or changing parts should only be performed by a certified FOTILE Service Technician.	 In the process of washing dishes in the functional sink (dishwasher cavity), use light liquid dish soap for tableware only, and do not use any foaming detergents.
 When you open the door after operation, hot steam may escape. Please stand away from the door to avoid scalds.	 Knives and other utensils with sharp points must be loaded in the basket with their points down or placed in a horizontal position.
 Please use new hoses to connect appliances to the water source. Do not reuse old hoses.	 Keep the plastic film and packing cases away from children to avoid suffocation accidents.
 For any operational errors, please stop using the product, unplug the power cord from the electrical outlet, and take the appropriate actions according to the "Troubleshooting" section in the Manual. If the problem still persists, please call FOTILE Customer Service at 1-888-315-0366.	

⚠ Caution

 Do not put objects with a lot of silt into the dishwasher, or it may disturb the normal operation of the product.	 Do not put jewelry, gold and other valuables into the sink for cleaning to avoid causing damage to the product and cleaned articles.
 Do not clean the glass with coarse cleaning agents, a metal pot scourer, a scouring pad with a rough surface, or sharp metal scrapers. These materials may scratch the glass surface and cause damage.	 The countertop the sink dishwasher will be installed into must have sufficient strength and height to support the product, and the dishwasher must be firmly installed in the countertop.
 The product may get hot during use. Please do not touch the heating elements of the product and their surrounding areas.	 In case the power cord is damaged, it must be replaced by a professional from the manufacturer's service department or similar department to avoid danger.
 Do not put heavy objects on the glass door of the product.	 Do not press the Start/Pause key frequently.
 Do not clean meat in the functional sink.	 Do not use multi-functional sockets with many plugs.
 Do not forcibly open the cover of the dishwasher door during power outage.	 Keep the complete machine away from heat sources and flammable materials such as gas and alcohol.
 During the operation of the product, do not pour water directly into the dishwasher sink, or it may cause abnormal operation of the product.	 After each cleaning, please clean out food debris in the debris basket before using it again in time.
 Do not use elongated materials such as chopsticks to poke the door lock hole, or the machine will not function properly.	 Please ensure the sewer pipe is not blocked. Blockage may cause abnormal operation of the product.

Notice: This product contains chemicals known to the State of California to cause cancer, and birth defects or other reproductive harm. For more information, please go to: www.P65Warnings.ca.gov

Main Technical Specifications

		2-IN-1 In-Sink Dishwasher		
Model		SD2F-P3/SD2F-P3L (dishwasher on the left)		
Overall Dimensions	W x D x H	35 1/4" x 19 5/16" x 21 11/16"		
	Height of Fully Opened Door (inch)	16 3/8"		
Counter Cutout Size	W x D x H	33 11/16" x 18 1/8" x ≥25"		
Basic Parameters	Power	1500W		
	Current	13A		
	Voltage	120V		
	Frequency	60Hz		
	Length of Power Cord	4ft		
	Water Pressure	20.3 psi -145.04 psi		
	Max Noise Level	57.8dB		
	Gross Weight	67.9lbs		
	Net Weight	49.8lbs		
	Power Consumption	178 kWh/year		
Included Accessories	1 Dish Washing Basket			
Function/Performance	Rinse Mode	For Dishes		
		Delicate	Normal	Intensive
	Highest Washing Temperature	122°F	158°F	158°F
	Washing Time	20minutes	45minutes	80minutes
	Total Water Consumption (gallon)	1.85	2.50	3.17
	Number of Water Cycle in the Full Process	3	5	5
	Maximum Washable Dinnerware Diameter	10inches		
	Variable Dish Rack	Yes		
	3D Fan Drying	Yes		
	Hidden Heating Plate	Yes		
	Standard Capacity	3sets		
	Material of Cavity	Food-grade Stainless Steel		
	Operation Mode	Micro-pressure Waterproof Touchscreen		
Digital Display Screen	Yes			
Automatic Reminder	Yes - When Cleaning Completed			
Water Leakage Protection	Yes			
Child Lock	Yes			

Overall Dimensions

Unit: inch(mm)

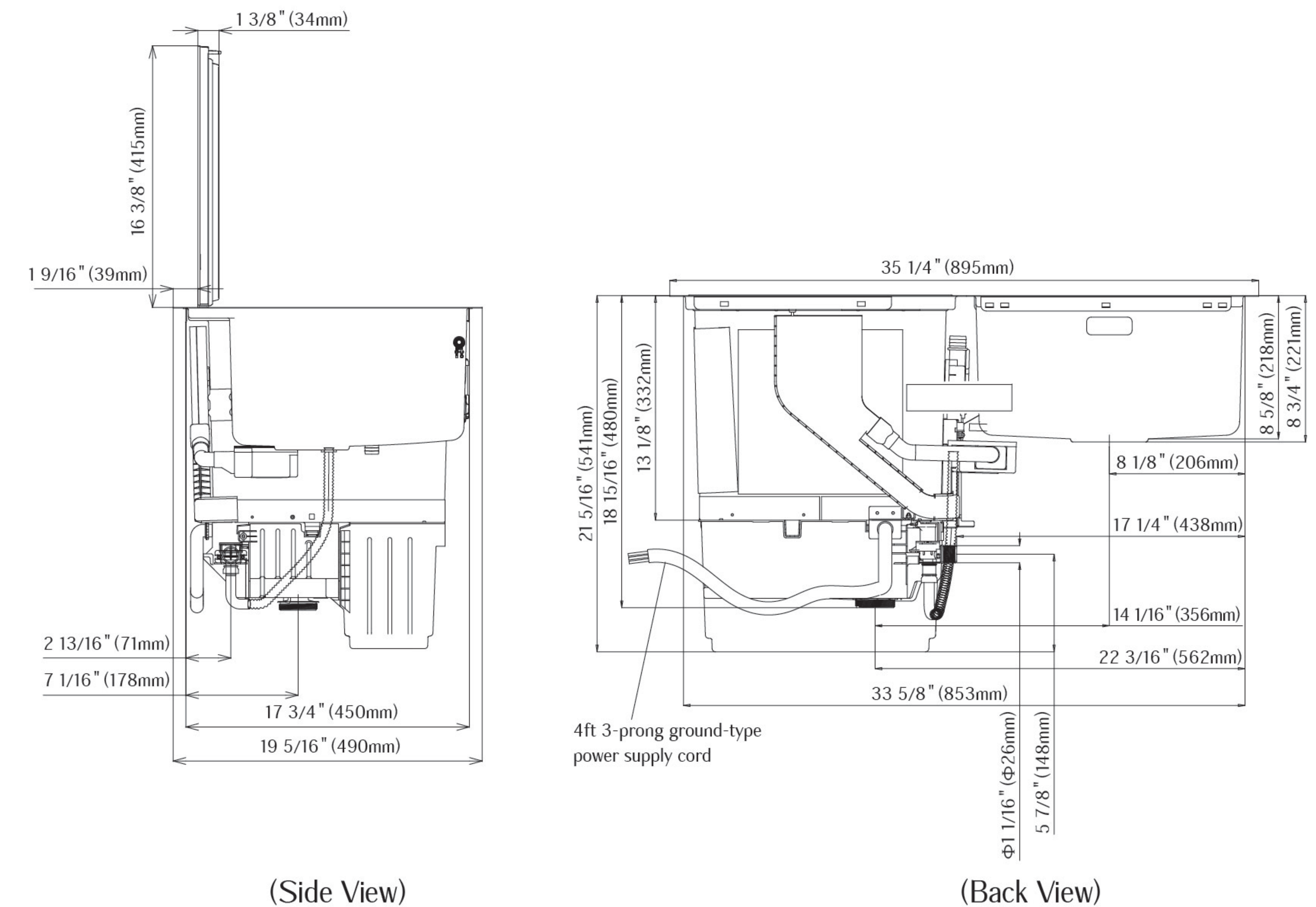





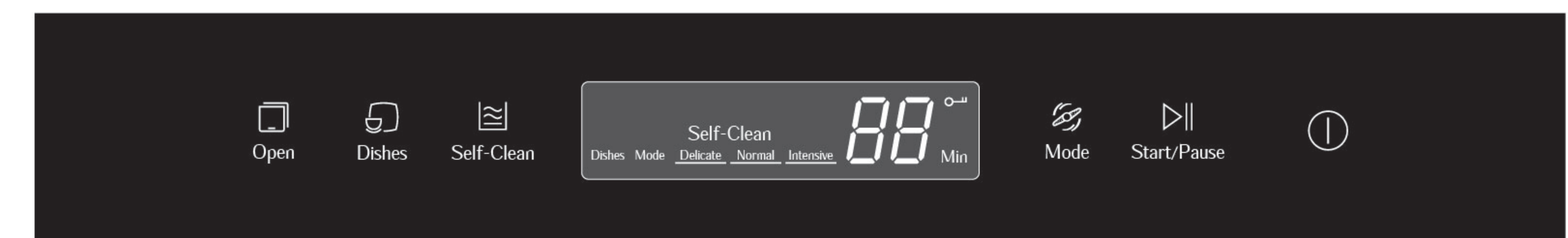

(Side View)

(Back View)

Operation Guidance

I. Operation Interface



1. Open key : Press the key to open the door in the non-working state; and press the Start/Pause key and then the Door key to open the door in the working state.
2. Dishes key : Press it to perform the Dishes Washing Program.
3. Self-clean key : Press the key to initiate the cavity cleaning procedure.
4. Display screen: It mainly displays information about the washing time, mode.
5. Mode key : Select delicate, normal or intensive washing programs.
6. Start/Pause key : Controls the start and pause functions of the product.
7. Power key : Controls power on and off.

II. Operation Instructions

■ Dish Washing Program

Place the dishes washing basket in the Dishwasher Chamber. Load all your dishes and tableware. Press and hold the Power key, and the number flashes → Press the Open key → Put in bowls and dishes → Select Dishes → Select mode (optional) → Press the Start/Pause key to start washing → Wash and dry the dishes → End of washing → Turn off the machine.



- Notes: 1. Bowls and dishes should be placed into the rack for cleaning.
2. Upon completion of washing, the screen displays 00. For emergency quick use of bowls and dishes, please press the Power Key and then press and hold the Open Key. Otherwise, the system enters the dishes drying state and then shuts down automatically after 30 minutes.

Washing Mode	Delicate	Normal	Intensive
Washable Dinnerware	Slightly dirty tableware	Generally dirty tableware	Heavily dirty tableware
Maximum Washing Temperature (°F)	122°F	158°F	158°F
Washing Time (minutes)	20 minutes	45 minutes	80 minutes
Total Water Consumption (gallon)	1.85 gallons	2.40 gallons	3.17 gallons
Recommended Amount of Detergent	5g/0.18oz	15g/0.53oz	15g/0.53oz

- Notes: 1. To have a better cleaning effect, add your dishwasher detergent before the placement of your tableware. If you are using dishwashing powder, place it at the bottom of the tank. If you are using a dishwasher pod, place it in the debris basket.
2. It's suggested that you pre-rinse your tableware to avoid any food debris that may interfere with the rotating spray arm which could affect the normal operation of the dishwasher.

■ Self-Cleaning

Press and hold the Power key, and the number flashes → Press the Open key → Select Self-clean key → Press the Start/Pause key → to start washing and drying → End of washing → Turn off the machine.



- Notes: 1. Upon completion of the washing, 00 is displayed on the screen. For emergency use of the dishwasher, please press the Power key, and then press and hold the Open key. Otherwise, the system shall enter the drying state and will shut down automatically after 30 minutes.
2. For an even better cleaning effect, add a descaling agent during self-cleaning.

◆ Usage of Secondary Sink Cover Accessory

- * If you purchase the Secondary sink cover accessory, you can use the dishwasher portion as a second sink. In order to use the Secondary Sink Cover accessory, take out the dishwasher basket from the dishwasher, and replace it with the Secondary Sink Cover covering the rotary spray arm.
- Water inflow: press and hold the Mode key for 2 seconds, when you hear a "click" sound, the drainage valve shall close, and the sink will start to fill with water.
 - Water drainage: press and hold the Start/Pause key for 2 seconds, when you hear a "click" sound, the drainage valve shall open, draining out the water. The drainage valve shall close automatically when its open time has exceeded 30 minutes.

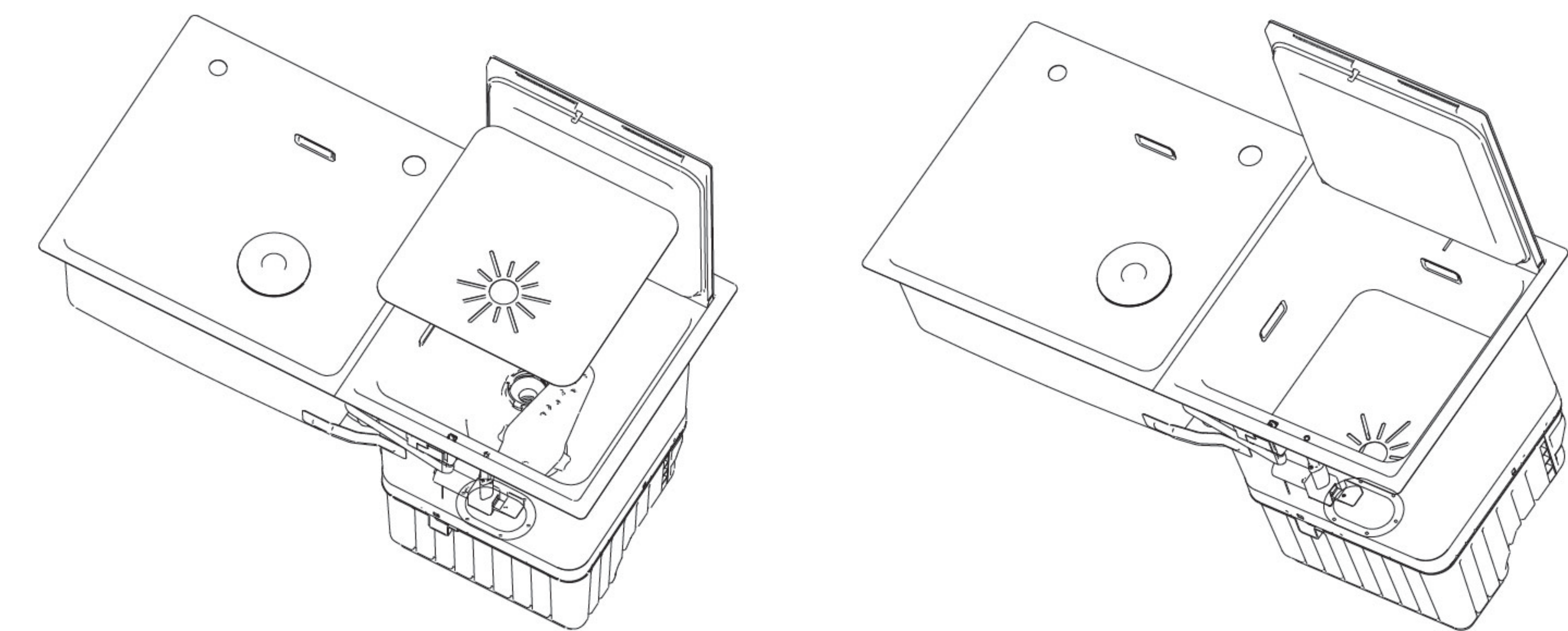

Tableware Placement

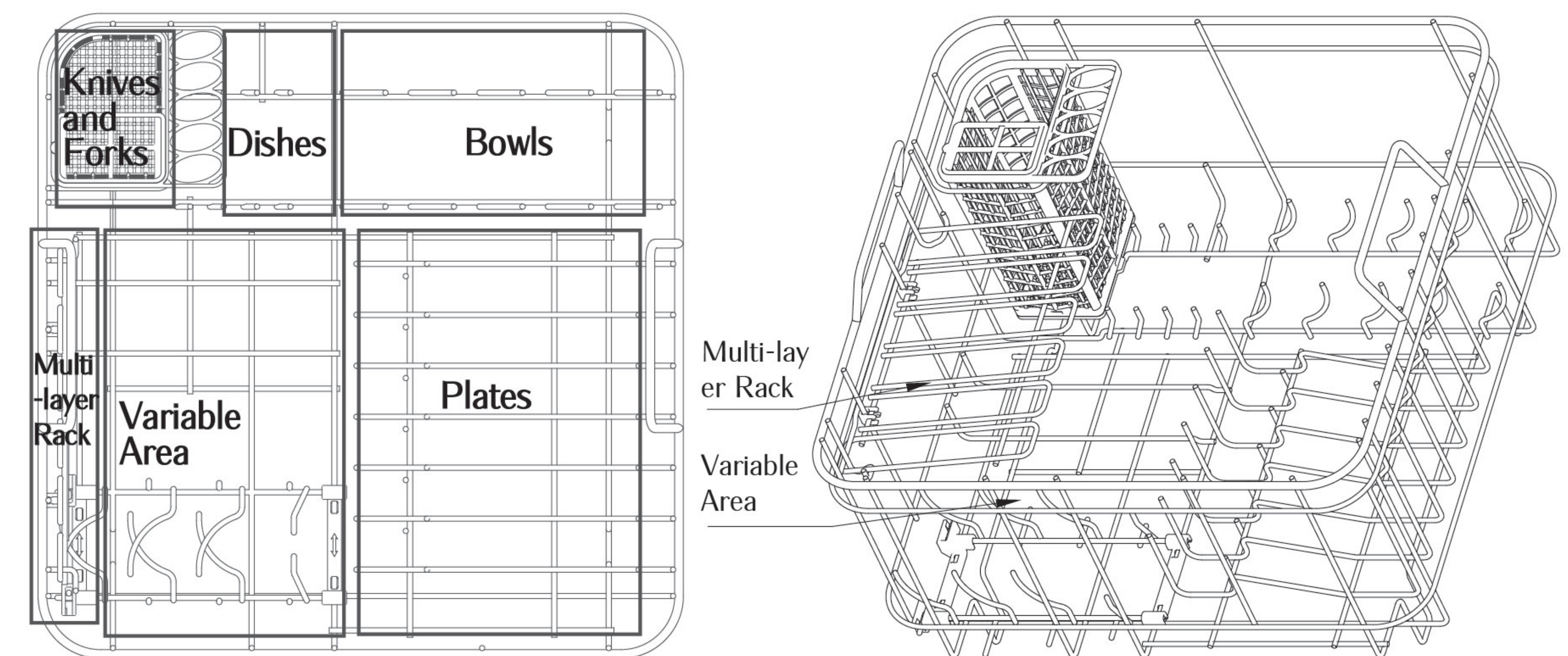

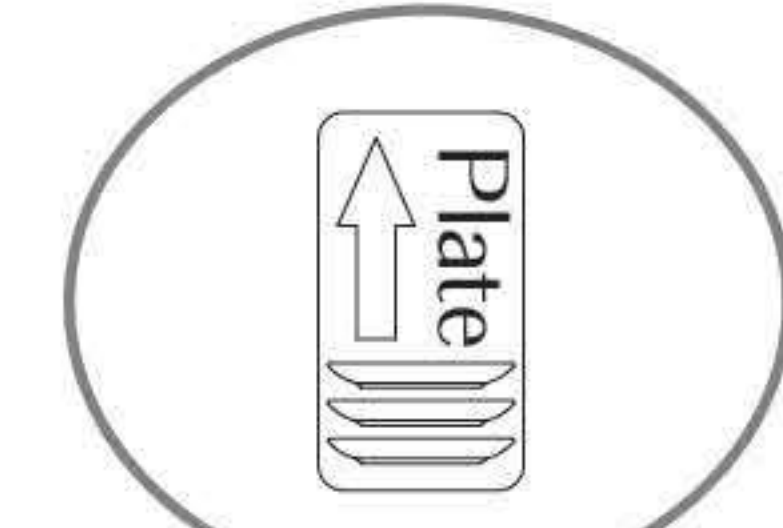
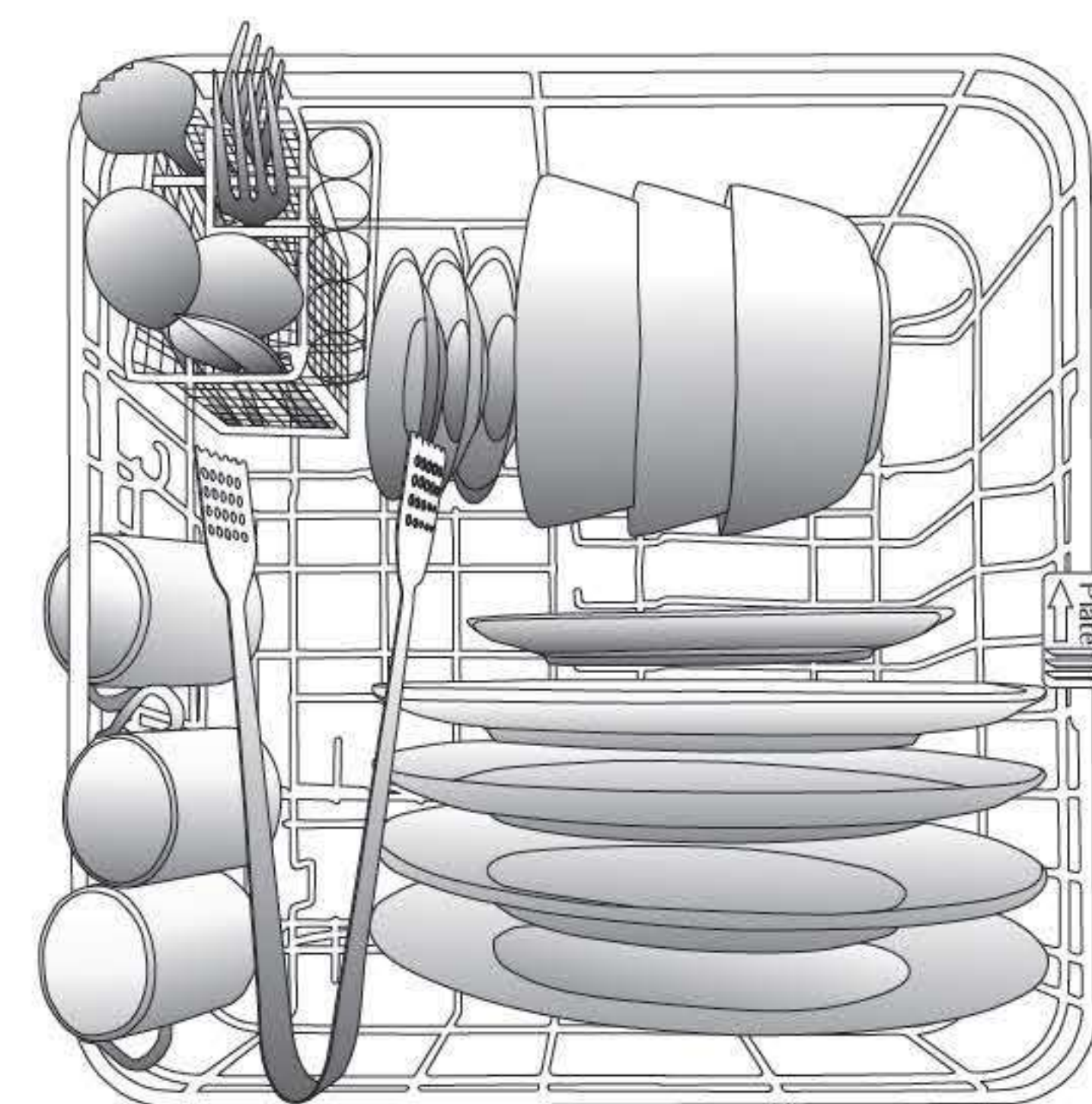
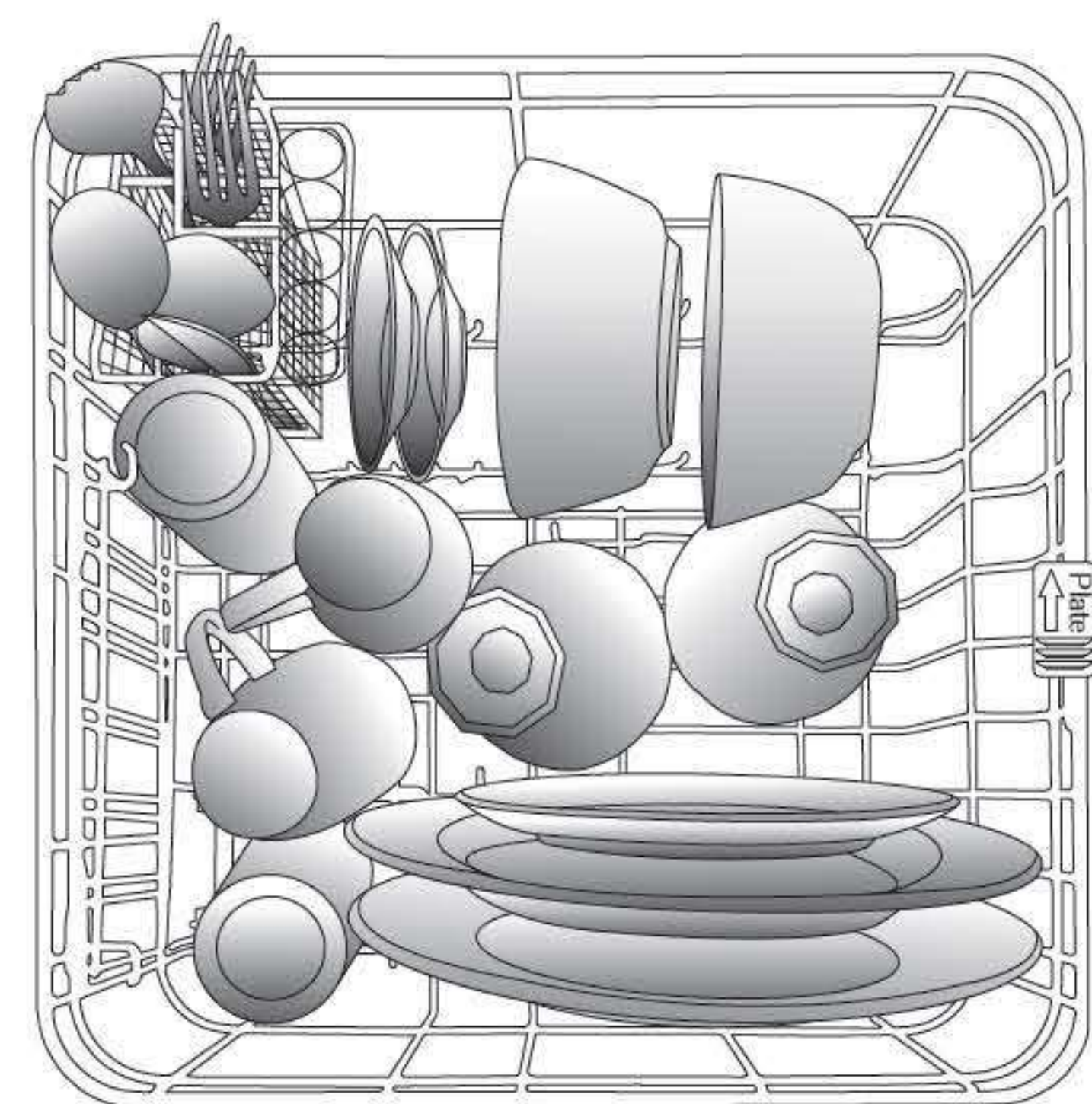

Please note:
To ensure effective washing, please keep the dishes in the same orientation as the pointed arrow on the side of the dishes washing basket.

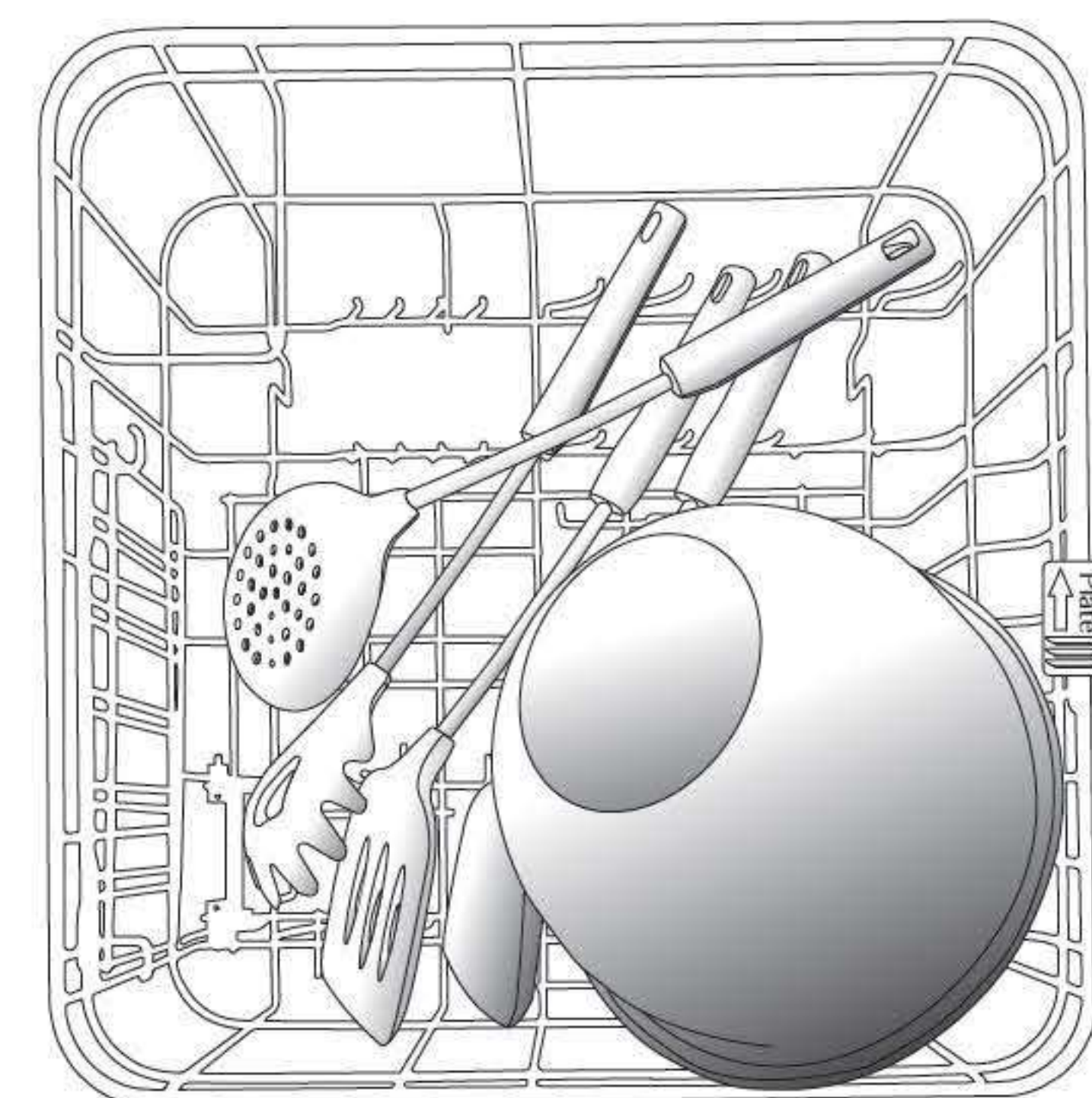
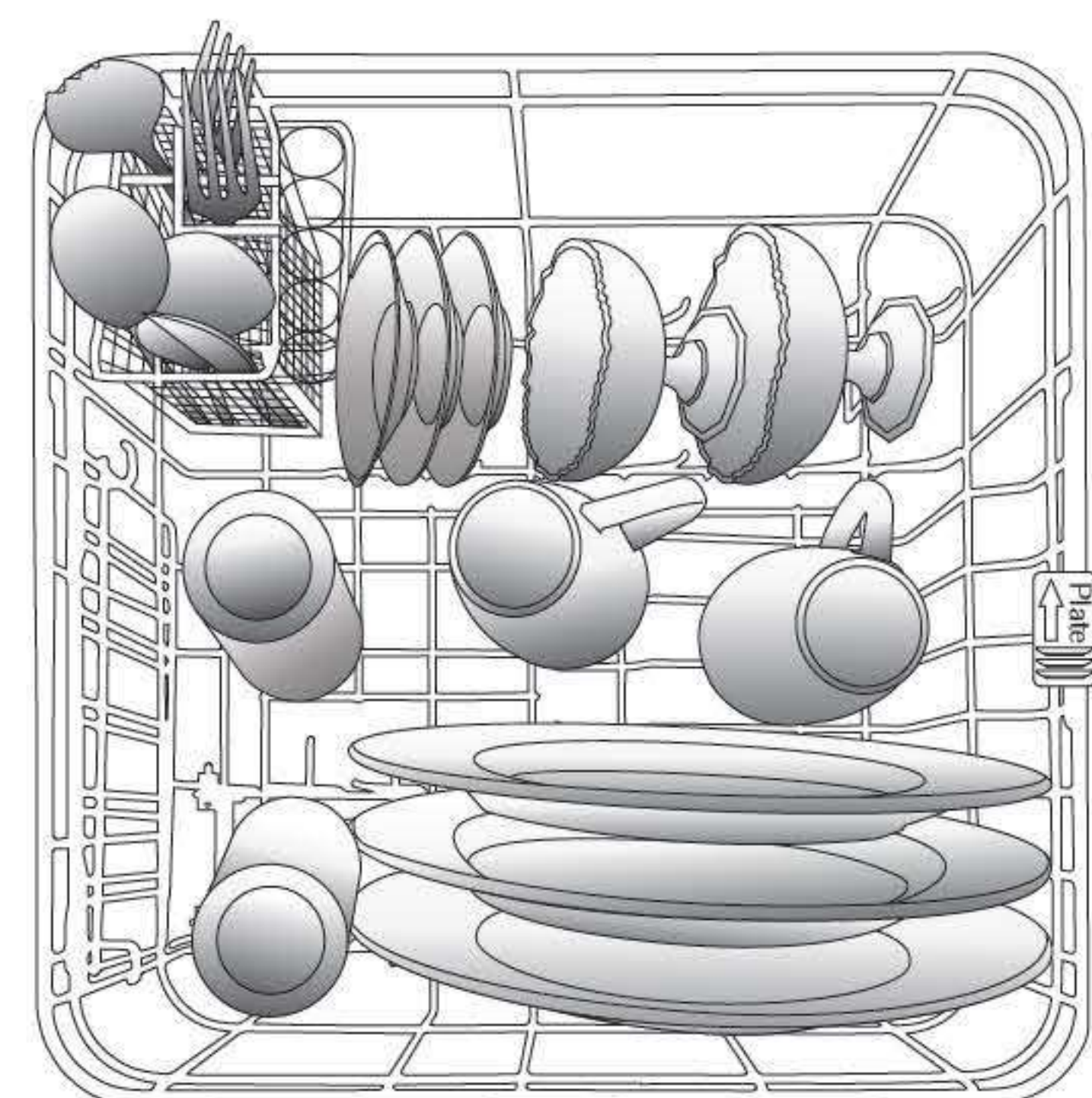

Schematic Diagram of Tableware Placement

Instructions for Tableware Placement:

1. Do not allow fragile items such as wine glasses to touch other tableware.
2. Avoid overlapping when loading tableware to ensure a good cleaning effect.
3. For fewer dishes, load tableware in intervals to improve the cleaning effect.
4. For tableware placement, please ensure that spoon handles and other tableware do not go beyond the bottom of the dish rack, which can interfere with the rotary spray arm.
5. When closing the door, please ensure that tableware, such as knives, forks, and spoons do not lean against the door. This will avoid damage to the dishwasher door.

Washable Tableware/Material

Tableware and Material	Washable or not	Tableware and Materials	Washable or not
Aluminum	Yes	Stainless Steel	Yes
Disposable Aluminum	No. The materials will break off and adhere to other dinnerware.	Pure Silver	Yes
Bottle and Can	No. The label is adhesive. It may block the spray arm and affect washing results.	Tin	No. It may erode and rust.
Cast Iron	No. It may rust.	Wooden Ivory	No. Unprocessed wood may distort and crack.
Ceramics	Yes	Knife with Hollow Handle	No. Adhesive from the knife may loosen and fall off due to the hot water under the heat of hot water.
Crystal	Yes	Copper and Bronze	No. It may distort and discolor due to hot water and detergent.
Aurum	No. It may discolor.		
Glass	No. It may discolor.		
Disposable Plastics	No. It cannot withstand hot water and detergent.		
High Temperature Plastics	Yes		

Note: For other special materials, please consult the FOTILE Customer Service Center.

Daily Cleaning

1. Open the door to gently clean any residual dirt left on the door.
2. Clean the walls and all the corners of the sink.
3. Remove the residue basket by turning it counterclockwise, pour out the residue and wash it.
4. Turn the rotary spray arm counterclockwise to remove and clean it.
5. Remove the filter screen and clean it.
6. Clean the bottom of the sink.
7. After cleaning, install the components to their original positions and make sure they are properly installed.

Remove and wash the debris basket:
Remove the debris basket counterclockwise, pour out the residue and wash it.

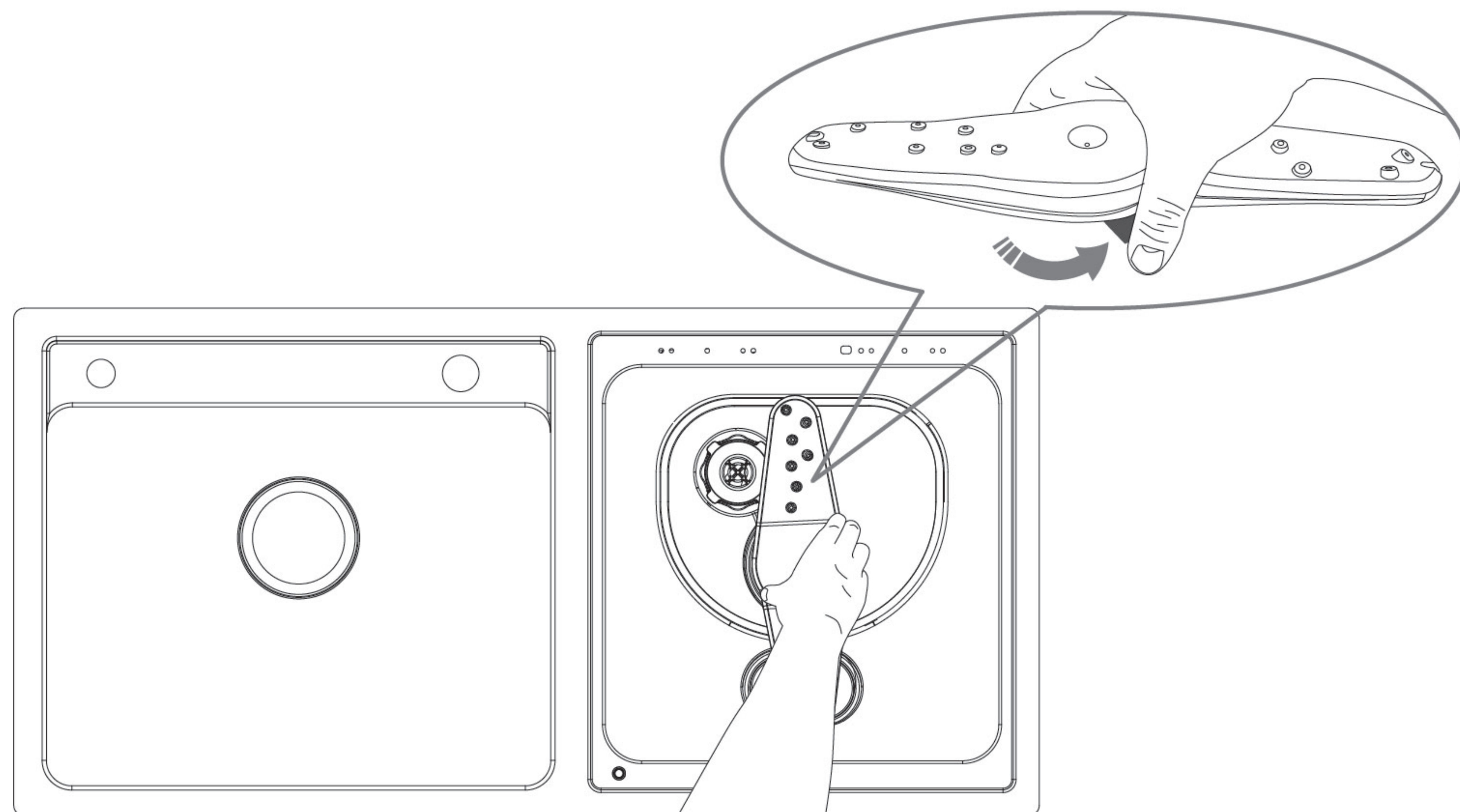
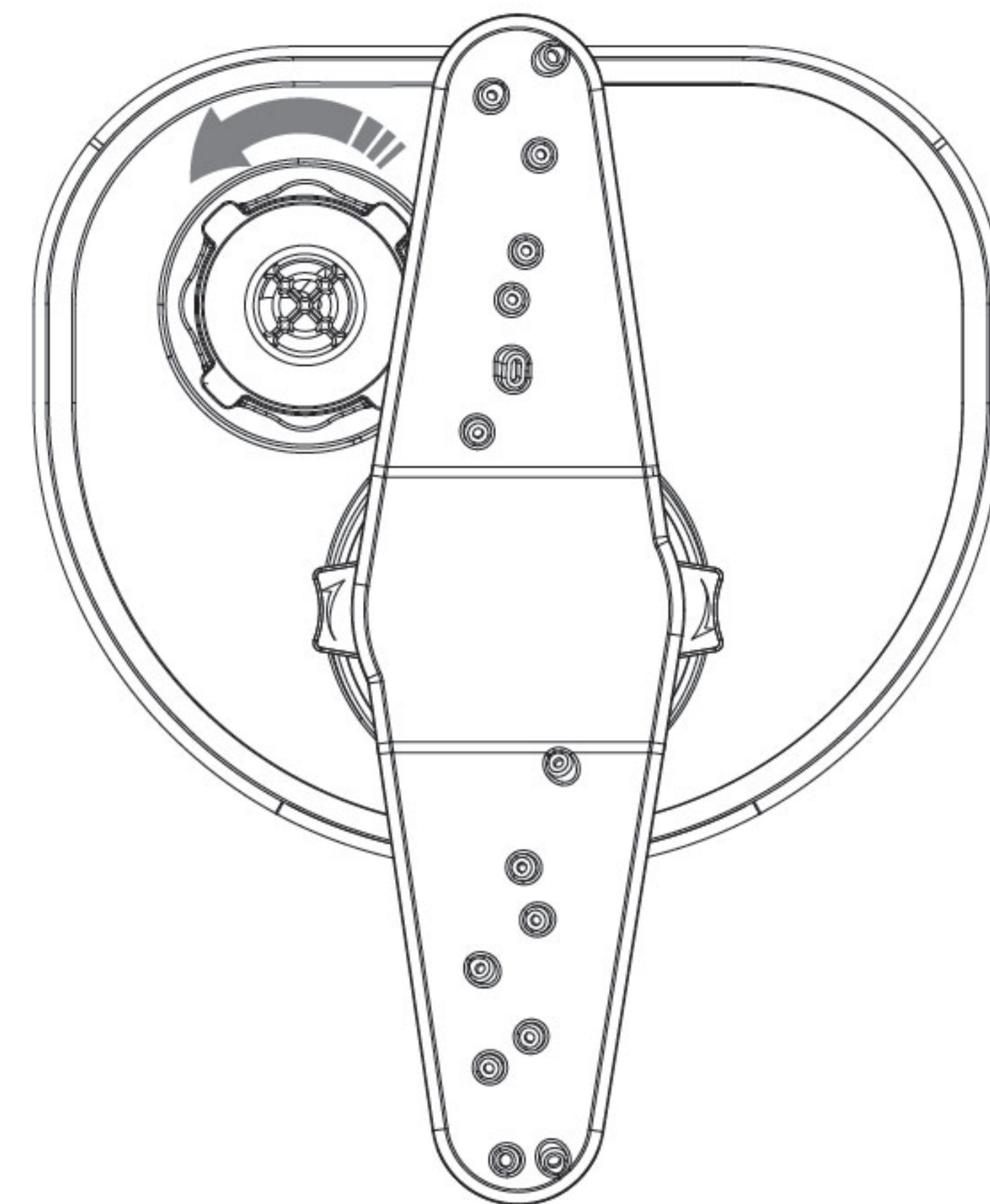

Remove and wash the spray arm:
Pinch the two gray raised snaps under the spray arm, press and rotate them counterclockwise to remove the spray arm for cleaning.

Install the spray arm:
Pinch the two gray raised snaps under the spray arm, press and rotate them clockwise. After hearing a "click" sound and if the spray arm rotates smoothly without any abnormal sound, the installation is considered to be complete.

Maintenance Recommendations

1. Do not use detergent to clean the sealing strip. The sealing strip may have holes or cracks as time elapses. If there are any holes or cracks, please change the sealing strip with a new one.
2. Cleaning the tempered glass panel of the door.
Wash by hand using hot water and a small amount of dishwashing liquid and a soft sponge. Dry it with a soft cloth after cleaning.
Do not use scouring pads, metal scourers or similar materials to rub against the glass surface.
3. Cleaning of the stainless-steel sink:

Daily Maintenance Techniques for the 304 Stainless Steel Sink

The sink dishwasher is made of 304 stainless steel. Please protect the sink from scratches!

1. If you are in the process of decoration, you may apply a layer of oil on the surface of the sink to prevent metal fragments from rusting. In addition, if you will not be using the sink dishwasher for a long time, please apply a layer of oil on the sink to protect it.
2. Wash the sink frequently with a neutral detergent and clean it thoroughly and gently with clean water.
Do not use steel brushes or coarse brushes. After cleaning, please dry it with a sponge or rag.
3. Do not put food with high salt content or erosive foods, such as lemons, sauce, pickles and mustard in the sink or on the panel for a long time to avoid erosion of the sink.
4. Try to keep the sink from contacting strong bleaching powder, household chemicals and soaps for a long time.
5. Try to keep sharp and hard utensils such as knives, forks and other kitchenware away from the sink to avoid scraping, scratching or denting the sink.
6. Do not put kitchenware made of low carbon steel or cast iron in the sink for a long time or leave steel wool, rubber dishwashing tablets, wet dishwashing sponges and other cleaning pads in the sink to prevent rust, mildew, etc., from forming overtime.
7. If the sink has rust, mildew, etc., please apply household toothpaste on the rust stain and spots and then wipe it off with a rag. Do not clean the sink with wire wool, polishing wheels or polishing materials.

4. The spray arm and the debris basket can be removed and washed by turning them counterclockwise to remove.
5. After washing, do not leave water on the control panel or it may affect normal usage.
6. After each washing session, please clean out the food debris in the debris basket immediately, or it may affect the machine's washing capability, and may also cause an unpleasant smell.
7. In case incrustation is formed in the functional sink (whitening of the surfaces of sink, heating plate, dish rack, etc.), please clean the sink with vinegar and soda ash / carbonate.
8. Self-cleaning of the sink is recommended at regular intervals or when reused after a long period of not being used.

Troubleshooting

If you find anything abnormal during the usage, please stop using the machine, pull out the power plug, and check following items:

Fault	Possible Cause	Repair Method
Abnormal sound	The spray arm is not installed properly.	Remove and reinstall the spray arm.
	Tableware is not placed as specified, causing collision.	Check if the tableware is placed in accordance with the standard requirements.
The display screen fails to launch and the key does not respond.	The power source is not connected.	Check if the power plug is plugged in.
Smelly	Lack of Cleaning.	Please maintain the product according to the daily cleaning steps.
Secondary Sink cannot drain	Accidentally touching the Mode key causing the drain valve to close.	In the shutdown state, please press and hold the Start/Pause for 2 seconds to open the drain valve.
Door cannot open	The power is cut off when the dishwasher is in use.	Open the lower cabinet, find the white door string, and gently pry the door armrest with a straight screwdriver at the same time of pulling down the string.
Display Code E1	Door opened.	Gently press the door downward.
	Door lock fault.	Please consult FOTILE customer service.
Display Code E2	Low water pressure.	Ensure the inlet valve is fully open.
		Please consult FOTILE customer service.
Display Code E8	Water leakage, or the door is not tightly sealed.	Ensure the inlet valve is fully open.
		Please consult FOTILE customer service.
Other Display Codes	/	Please consult FOTILE customer service.

Customer Service

All FOTILE dishwasher products enjoy five-year limited warranty, including 1 Yr full warranty on Parts and Labor, and 4 Yr limited warranty on the dishwasher motor only.

The following circumstances do not fall into the scope of warranty:

- Free door-to-door service, confirming installation conditions, or guiding how to use the product, etc.
- Improper transportation, installation or maintenance conducted by user voluntarily.
- Product failure caused by abuse, misuse, modification, or use for other purposes or commercial purposes.
- Damage caused by cleaning and maintenance not in accordance with the instructions.
- Product damage caused by accident, fire, flood, force majeure, etc.
- Failure and damage caused by using the product beyond the normal operating conditions, e.g. the voltage is too high.
- Discrepancy between the information on the purchase voucher and the warranty registration information of the product.

This warranty covers original purchasers and any subsequent owners purchased the product in US. If the product is located in a place where authorized service of FOTILE cannot reach, you shall be responsible for paying the corresponding transportation expenses, or you shall need to take the product to the authorized service office for maintenance.

- If you have purchased FOTILE sink dishwasher product, please register as soon as possible, so we can communicate with you and provide our services when you need them. You can register your product using two methods:
 - Fill out the paper product registration card attached in the product package

and mail it to FOTILE.

- Log into the FOTILE Website for product registration: <https://us.fotileglobal.com/pages/product-warranties-registration>
 - If you have purchased the FOTILE sink dishwasher product, please inform us of the product model and serial number when communicating, which can help us serve you better.
- You can find the information at position A in the diagram:

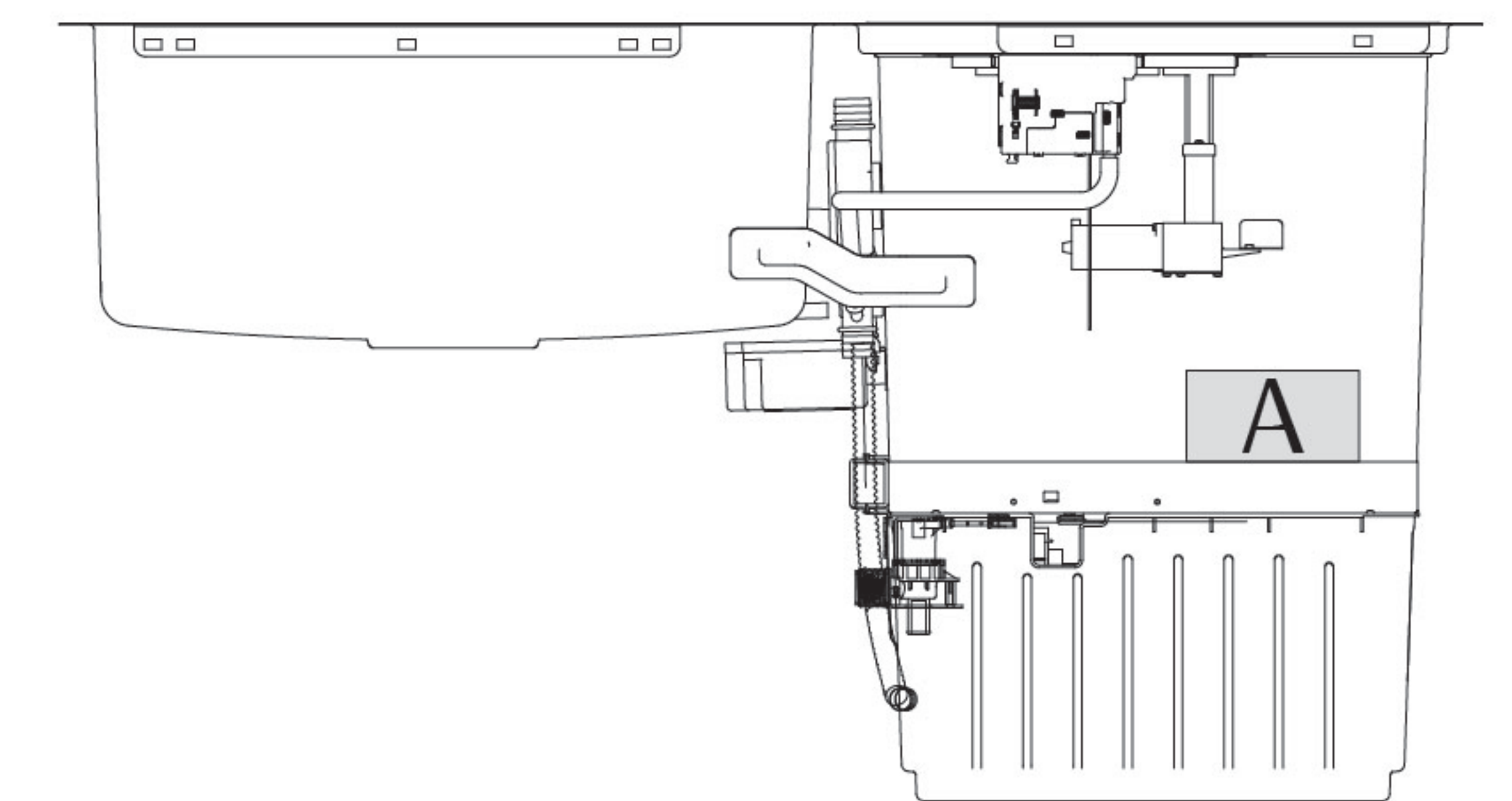

- If you need to buy accessories, you can go for one of the following selections:
 - Visit the official mall of FOTILE: <https://shop.fotile-global.com/>, to understand and purchase our product.
 - Call the FOTILE Customer Service Center 1(888)-315-0366, for consultation and purchase.
 - Contact the official authorized store of FOTILE (you can inquire the authorized store in your city by visiting the official website of FOTILE, <https://us.fotileglobal.com/>, for consultation and purchase.
- If you need other services, please feel free to contact FOTILE by the following ways:
 - Toll Free: 1(888)315-0366
 - Customer service email: serviceusa@FOTILE.com (Please leave a phone number for daytime contact)
 - Mailing address: 6 Campus Dr, Suite 210, Parsippany, NJ 07054

Exploded View

SD2F-P3

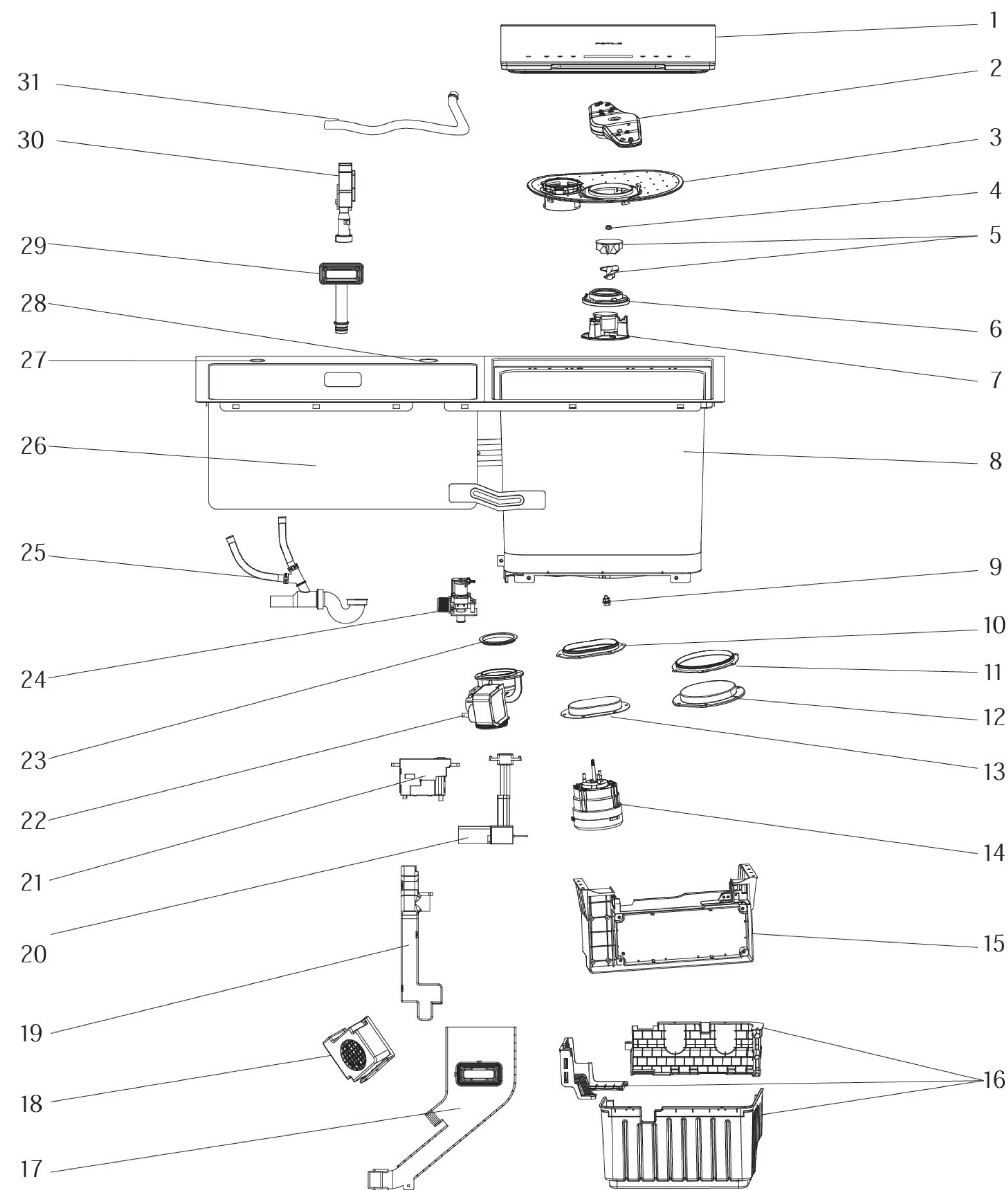

- | | |
|--|---|
| 1. Door | 17. Assembly of air intake seat |
| 2. Spray arm | 18. Fan assembly |
| 3. Filtering screen | 19. Cable bracket |
| 4. Vane locknut | 20. Door motor |
| 5. Impeller (upper and lower) | 21. Door lock |
| 6. Motor cover | 22. Drain valve |
| 7. Diversion base | 23. Seal ring of drain valve |
| 8. Functional sink | 24. Inlet valve |
| 9. Temperature sensor | 25. Sewer adapter hose assembly for functional sink |
| 10. Sealing gasket for ultrasound transducer | 26. Sink |
| 11. Sealing gasket for heating plate | 27. Installation hole of soap dispenser |
| 12. Heating plate | 28. Faucet mounting hole |
| 13. Cover plate | 29. Overflow port for the sink |
| 14. Motor | 30. Overflow port for functional sink |
| 15. Electrical box | 31. Power cable |
| 16. Bottom cover | |

SD2F-P3L

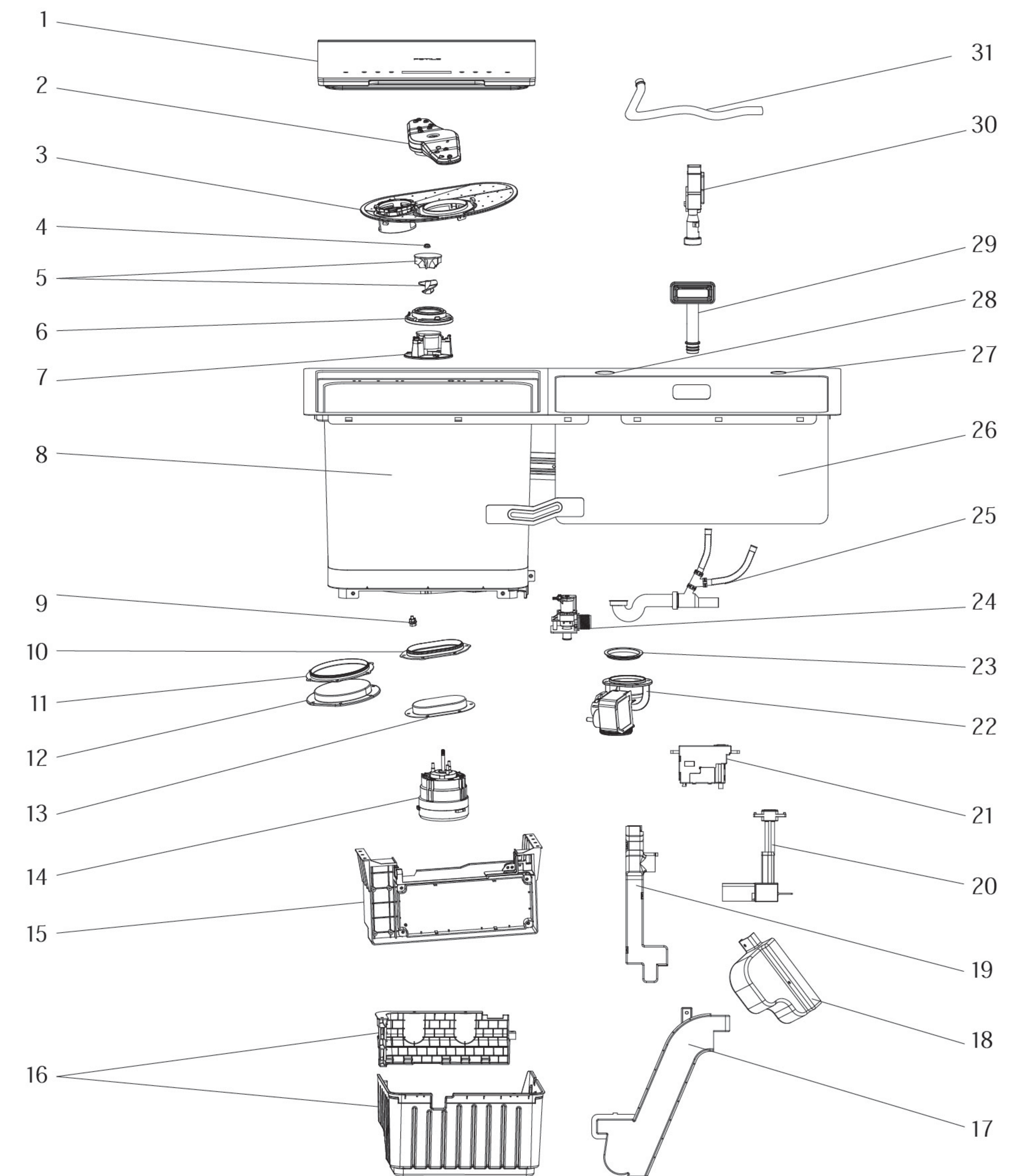

- | | |
|--|---|
| 1. Door | 17. Assembly of air intake seat |
| 2. Spray arm | 18. Fan assembly |
| 3. Filtering screen | 19. Cable bracket |
| 4. Vane locknut | 20. Door motor |
| 5. Impeller (upper and lower) | 21. Door lock |
| 6. Motor cover | 22. Drain valve |
| 7. Diversion base | 23. Seal ring of drain valve |
| 8. Functional sink | 24. Inlet valve |
| 9. Temperature sensor | 25. Sewer adapter hose assembly for functional sink |
| 10. Sealing gasket for ultrasound transducer | 26. Sink |
| 11. Sealing gasket for heating plate | 27. Installation hole of soap dispenser |
| 12. Heating plate | 28. Faucet mounting hole |
| 13. Cover plate | 29. Overflow port for the sink |
| 14. Motor | 30. Overflow port for functional sink |
| 15. Electrical box | 31. Power cable |
| 16. Bottom cover | |

目 录

尊敬的用户，您好！

感谢您选购方太公司为您精心制造的方太系列产品。
 使用和安装前，请您务必认真阅读此说明书相应内容并遵从要求操作。这对于维持产品的良好工作状态十分重要，也有助于您获得满意的下厨体验。
 我们建议您，任何时候如有需要维修或服务时，请与方太公司服务中心联系，以便我们能及时为您服务。

方太厨电，全球厨房的幸福选择！

安全须知	40
产品参数	43
操作指导	44
餐具摆放	47
可清洗餐具/材料	48
日常清理	48
保养建议	49
故障排除	50
客户服务	51
爆炸图	52

安全须知

为了避免对使用人员及其他人员造成危害及财产损失，特作如下区分及标志。



以下均为有关安全的重要事项，敬请严格遵守，并在充分理解内容的基础上正确使用。

本产品不适合具有身体、感官或精神缺陷或缺乏经验及知识的人士（包括儿童）使用，但由其安全负责人对其使用提供监督或指导的情况除外。

请照看好儿童，本产品不能用于玩耍。

若电源线损坏，为避免危险，必须由制造商、其服务代理或具有类似资格的人员予以更换。

根据危害、损害程度进行的内容区分

 危险	若忽视这一标志，并进行错误操作，易导致人员危险、重伤或引起火灾。
 警告	若忽视这一标志，并进行错误操作，有可能导致人员危险、重伤或引起火灾。
 注意	若忽视这一标志，并进行错误操作，有可能导致人员受伤或造成物品损害。

注意、禁止内容的图标





注意：玻璃的钢化机理决定了存在极小概率的钢化玻璃自爆。一旦发生非使用不当造成的自爆，我公司承诺免费更换该配件。

本说明书各项规定若有与国家法律强制性规定相冲突之处，请以法律规定为准。

* 特别说明：请严格按照本说明书规定使用，由于本产品不当使用造成的任何财产损失、人身损害，本公司不承担责任。

 危险	
 严禁电源插头、电源线接头、接插件等电器部件沾水，如果沾水使用可能会导致触电或其他意外伤害。	 请不要对电源线进行改制、拉伸、结扣及施加重物挤压等。否则易导致电源线破损而发生触电和火灾等事故。
 请勿让儿童单独使用本产品或靠近产品底部，否则有可能会造成触电或其他意外伤害。	 请勿用湿手触摸电源插头、电源线接头或电器部件，否则易发生触电事故。
 在提供安装和维修服务之前，必须切断电源，以免触电。	 禁止使用酒精等易燃溶剂清洗槽体。

 危险	
 严格执行 移动产品时注意槽体边角，以免割伤。	 小心烫伤 产品运行时，请勿强行打开门体，溅出的热水可能会导致烫伤。
 需要接地 插座必须具有可靠的接地线，以确保安全。不得将接地线接于煤气罐、自来水管、避雷针及电话线上。接地不良可能引起触电及其他事故。	

 警告	
 禁止 请勿使用接触不良或松动的电源插座，否则可能导致触电、短路、起火。保证电源线固定布线稳定可靠连接，否则可能导致触电、短路、起火。	 严格执行 儿童、行动不便者或缺乏相关经验和知识的人士，必须在负责其安全人员的监督下或了解设备安全及相关危险的人员指导下才可使用本洗碗机，否则可能造成烫伤、触电或其他意外伤害。
 禁止 功能槽门体自动顶开状态下，请勿强行关闭门体，否则会导致门体损坏。	 禁止 不要直接用热水接通进水管路，会影响产品正常使用。
 小心烫伤 不要在产品运行时触摸加热装置，可能会导致烫伤。	 严格执行 如果产品使用中发生漏水，请停止使用并立即与方太售后联系。
 禁止拆卸 非专业人员不得擅自拆机维修或更换零件。	 禁止 清洗餐具，禁止在槽体内放入洗洁精或泡沫类洗涤剂，否则会造成洗不干净。
 严格执行 工作完毕后，开门有热气喷出，人应站在离门稍远处，以免被热气烫伤。	 严格执行 刀和锋利的用具必须装在碗架里，并且尖端朝下或水平放置。
 严格执行 建议使用全新进水组件。请勿重复使用旧的进水组件。	 严格执行 请勿让儿童玩耍塑料薄膜和包装箱，这可能会产生窒息事故，所以请让包装材料远离儿童，包装材料不是玩具。
 严格执行 如果出现任何故障，请切断产品电源，停止使用，并按“常见故障识别与处理”进行相应处理。	

⚠ 注意	
 请勿将带大量泥沙的清洗物放置产品中，可能会导致产品无法正常工作。	 请勿将珠宝、黄金等贵重物品放入洗涤槽内清洗，以免损坏产品及清洗物。
 请勿用粗糙的擦洗剂、金属清洁球、百洁布的粗糙面或锋利的金属刮刀清洁玻璃，会划伤玻璃表面。	 请勿使用多个插头的多功能插座。
 产品在使用期间会发热，注意避免接触产品的发热元器件及周边位置。	 请勿将重物放置在产品的玻璃上。
 如果电源软线损坏，为了避免危险，必须由制造商、维修部或类似部门的专业人员更换。	 请勿连续频繁的按压“开始/暂停”键。
 请勿将肉类放置于功能槽内进行洗涤。	 安装产品的台面要有足够的支撑强度和高度，整机必须牢固的安装在台面上。
 停电时，请勿强行打开功能槽门体盖板。	 整机应远离热源以及煤气和酒精等易燃物。
 产品运行时，不得直接将水倒入功能槽中，否则可能会导致产品无法正常工作。	 每次洗涤结束后，渣篮中的食物残渣请及时清理。
 请勿使用筷子等细长物品来捅门体锁孔，否则机器可能无法正常工作。	 保证下水管道畅通，管道堵塞可能导致产品无法正常工作。

提示：本产品可能会使您暴露于化学物质，加利福尼亚州已知该化学物质可致癌和出生缺陷或其它生殖危害。
如需了解更多信息，请访问：www.P65Warnings.ca.gov

产品参数

		2-In-1 In-sink Dishwasher		
型号		SD2F-P3/SD2F-P3L(功能槽在左侧)		
产品尺寸	长 x 宽 x 深 (inch)	35 1/4" x 19 5/16" x 21 11/16"		
	完全打开后的门体高度 (inch)	16 3/8"		
开孔尺寸	长 x 宽 x 深 (inch)	33 11/16" x 18 1/8" x ≥25"		
基础参数	功率(W)	1500W		
	电流(A)	13A		
	电压(V)	120V		
	频率(Hz)	60Hz		
	电线长度(ft)	4ft		
	水压(psi)	20.3 psi -145.04 psi		
	最大噪音(dB)	57.8dB		
	毛重(lb)	67.9lbs		
	净重(lb)	49.8lbs		
	耗电量	178 千瓦时/年		
随带附件	1个碗碟清洗篮			
产品功能/性能	清洗模式	碗碟清洗		
		轻柔	适中	强劲
	最高清洗温度(°F)	122°F	158°F	158°F
	清洗时间(分钟)	20分钟	45分钟	80分钟
	总耗水量(加仑/次)	1.85	2.50	3.17
	全过程水循环数	3	5	5
	最大可清洗餐盘直径	10inches		
	可变碗架	是		
	3D风扇烘干	是		
	隐藏式加热盘	是		
	可容餐具套数	3		
	内腔材质	食品级不锈钢		
	操作方式	微压屏防水触控		
	数码屏显示	是		
自动提醒	是-结束清洗后			
漏水保护	是			
童锁	是			

产品尺寸



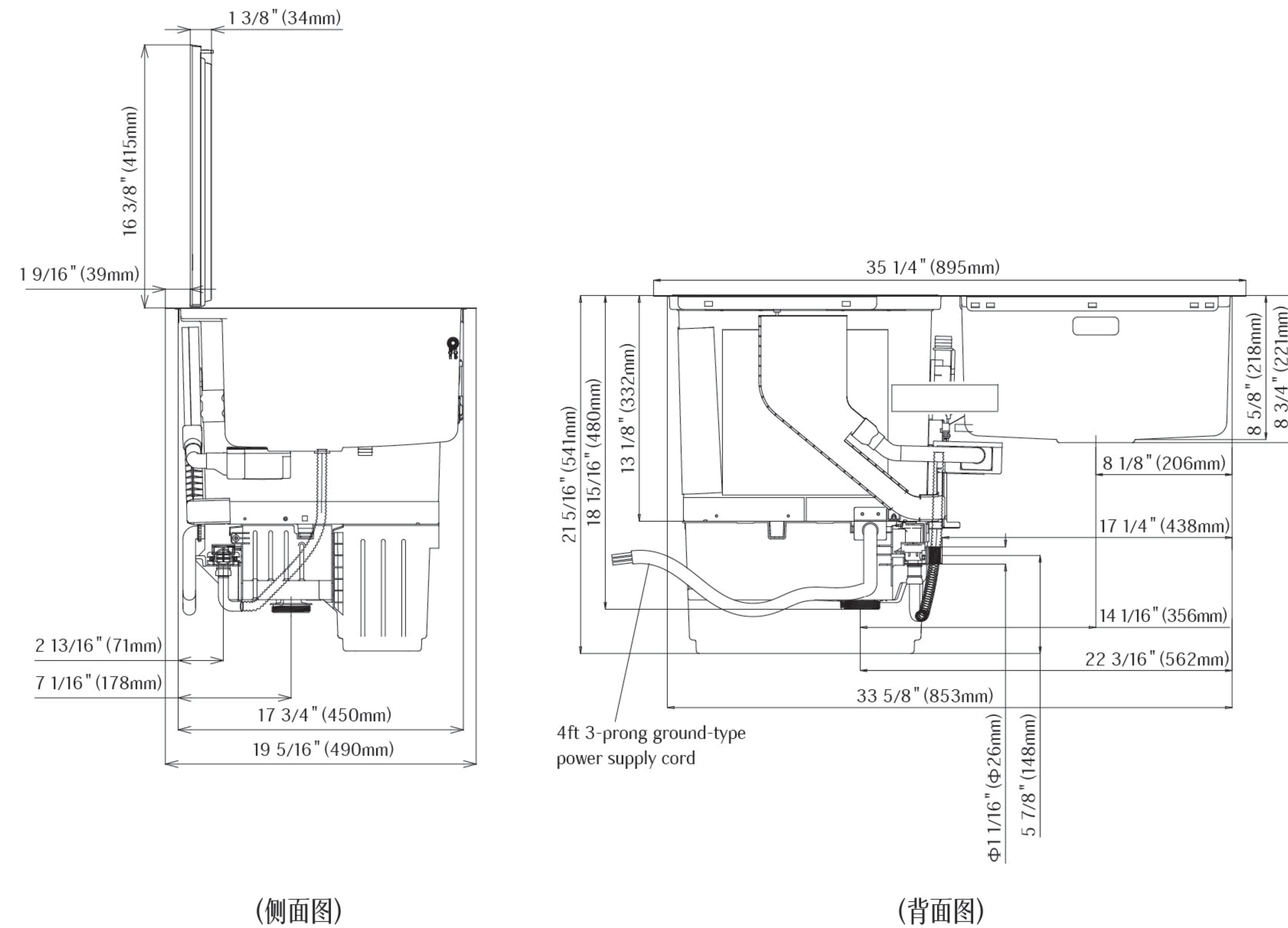



单位: in(mm)

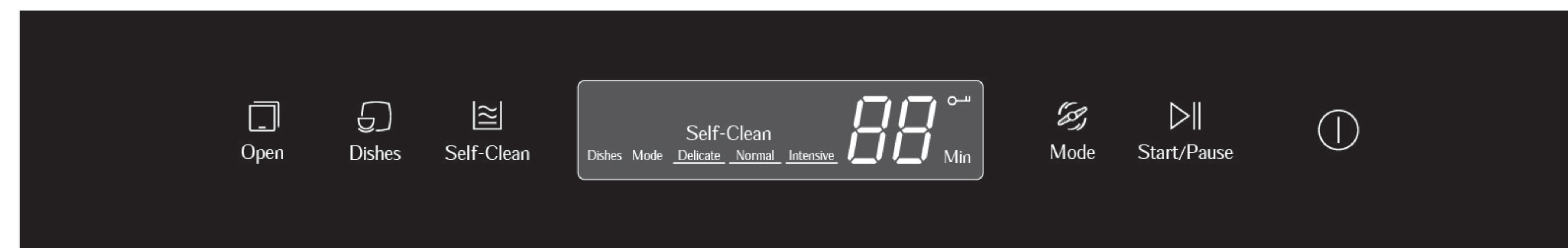

操作指导

一、操作界面



1. “开门”键 : 按压开门键, 非工作状态下可打开门体; 工作状态下需按压“开始/暂停”键, 再按“开门”键, 可打开门体。
2. “碗碟”键 : 按压碗碟键, 可进入洗碗程序。
3. 自清洁键 : 按压自清洁键, 可进入腔体自清洁程序。
4. 显示屏: 主要显示洗涤时间、模式等相关信息。
5. “强度”键 : 洗碗程序中, 可选择轻、中、强三个档位。
6. “开始/暂停”键 : 控制产品的开始和暂停。
7. “开关”键 : 控制电源的开启和关闭。

二、操作说明

■ 碗碟清洗

长按“开关”键, 此时数字闪烁→ 按压“开门”键→ 放入碗碟→ 选择“碗碟”→ 选择强度(可选)→ 按“开始/暂停”键开始洗涤→ 洗涤并烘干餐具→ 洗涤结束→ 关机。



注: 1. 碗碟需放入碗架, 才能入洗碗机清洗。

2. 洗涤完成后, 屏幕显示 00。若急需取碗碟, 按压电源键, 然后长按开门键即可。否则系统进入餐具烘干状态, 30分钟后自动关机。

清洗强度	轻柔	标准	强劲
建议清洗	轻油污餐具	一般脏污的餐具	严重脏污的餐具
最高清洗温度(°F)	122°F	158°F	158°F
洗涤时间(分钟)	20分钟	45分钟	80分钟
总耗水量(加仑)	1.85加仑	2.40加仑	3.17加仑
建议洗涤剂用量	5g/0.18oz	15g/0.53oz	15g/0.53oz

注: 1. 为获得更好的清洗效果, 在放入餐碟之前, 可先放入洗涤剂。洗碗粉直接撒入洗碗槽底部即可, 如果使用洗碗块, 请放置于滤篮中。

2. 清洗的碗碟建议进行预处理, 以免残渣干扰喷淋臂旋转, 影响正常使用和清洗效果。

■ 自清洁

长按“开关”键, 此时数字闪烁→ 按压“开门”键→ 选择“自清洁”→ 按“开始/暂停”键→ 开始洗涤并烘干→ 洗涤结束→ 关机。

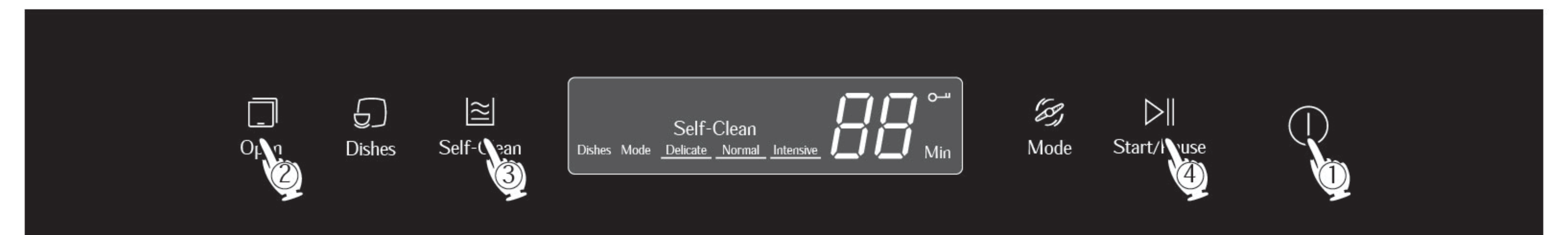

注: 1. 洗涤完成后, 屏幕显示 00。若急需使用, 按压电源键, 然后长按开门键即可。否则系统进入烘干状态, 30分钟后自动关机。

2. 自清洁时, 加入除垢剂, 更有利于清洁效果。

◆ 魔术底的使用

* 若您购买了魔术底水槽配件，可将洗碗机槽作为第二个水槽使用。使用时，取出菜篮/碗架，将魔术底撑脚向下，放入功能槽，盖住喷淋臂即可。

- 进水：长按强度键2s，听到咔哒声，排水阀关闭，可进水。

- 排水：长按开始/暂停键2s，听到咔哒声，排水阀打开，即可排水。排水阀打开时间超过30分钟，就会自动关闭。

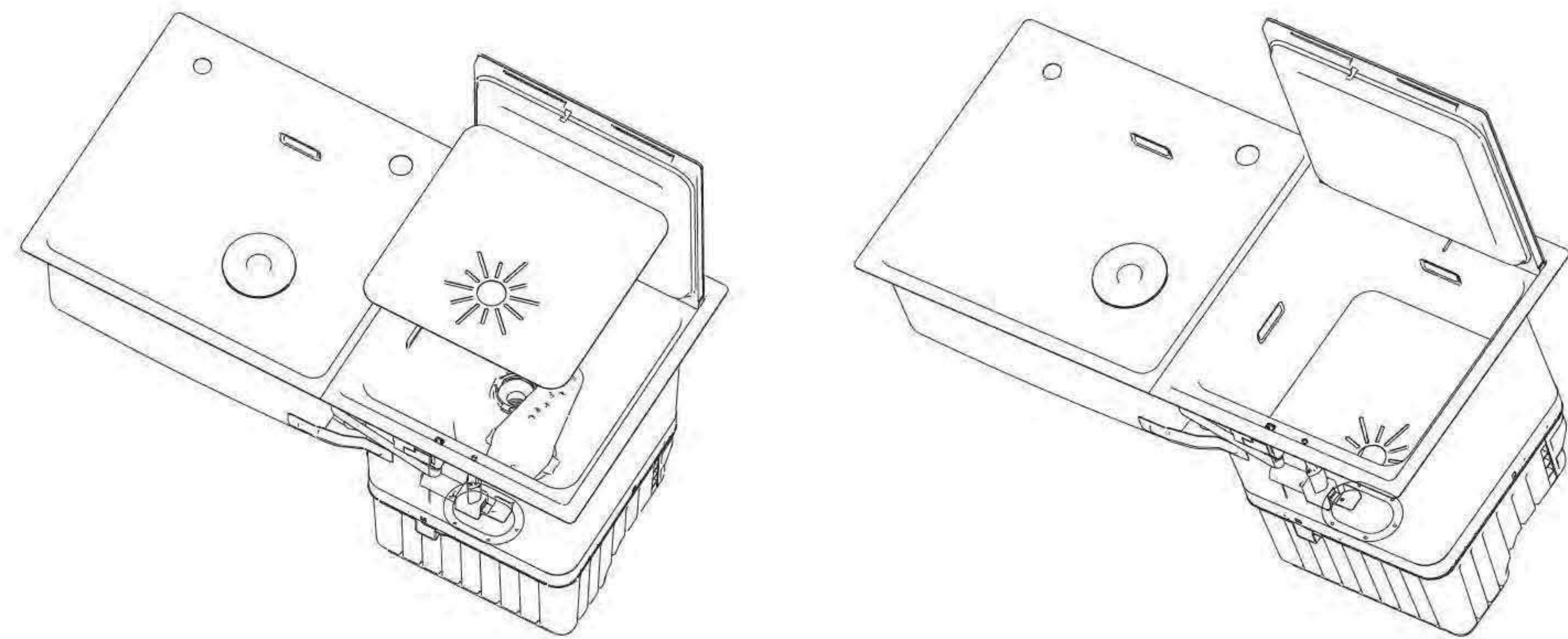

餐具摆放

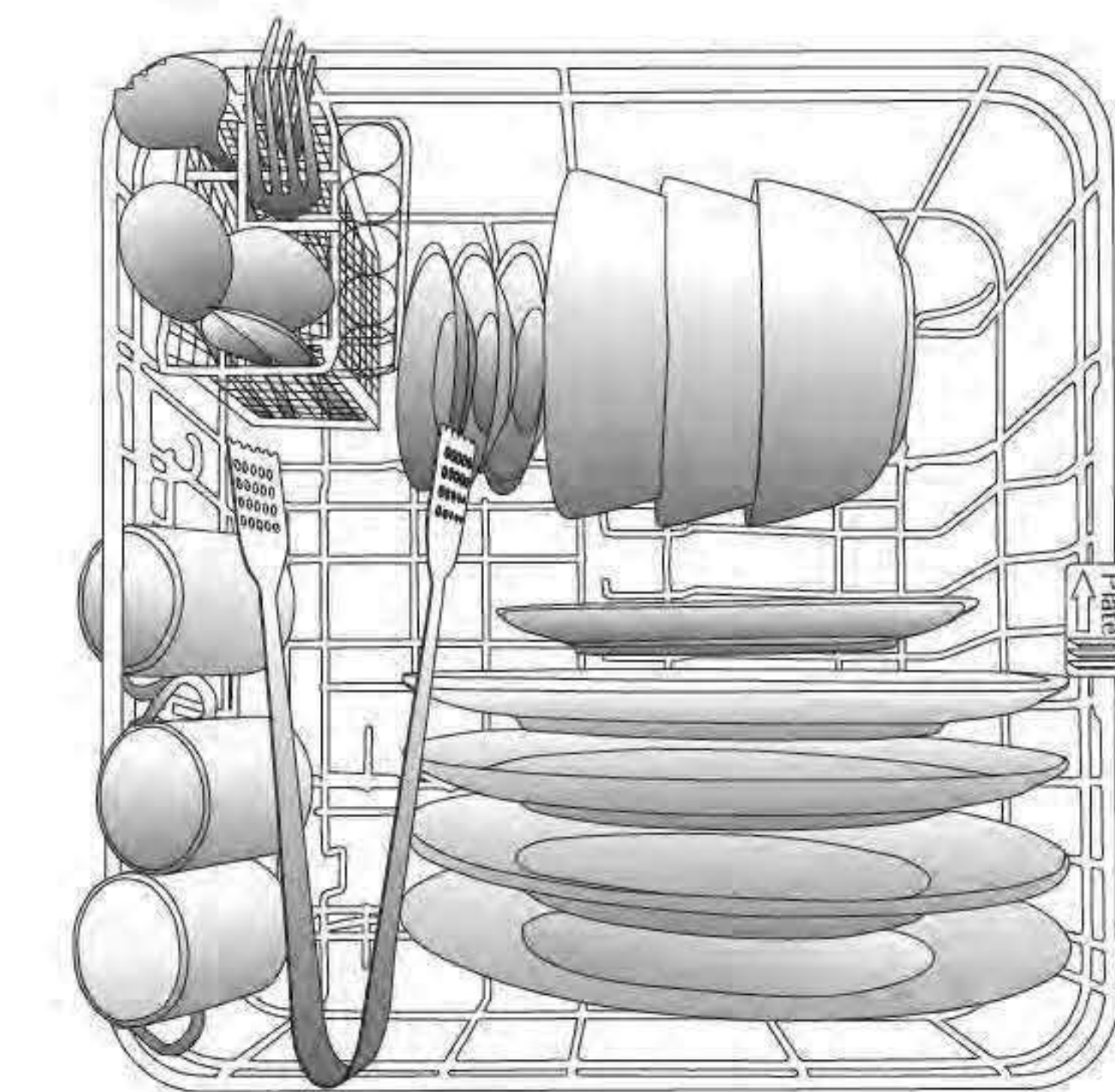
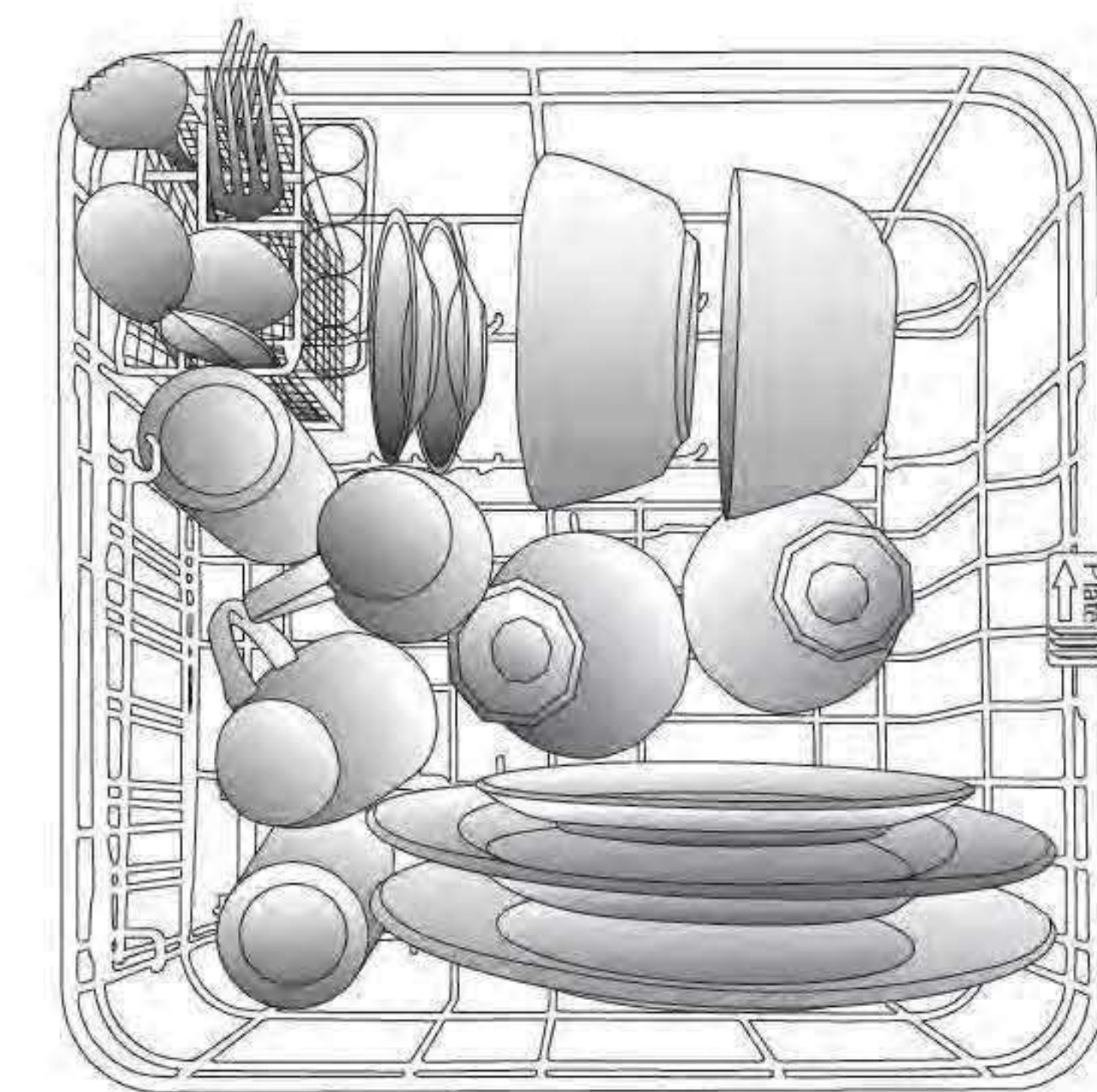
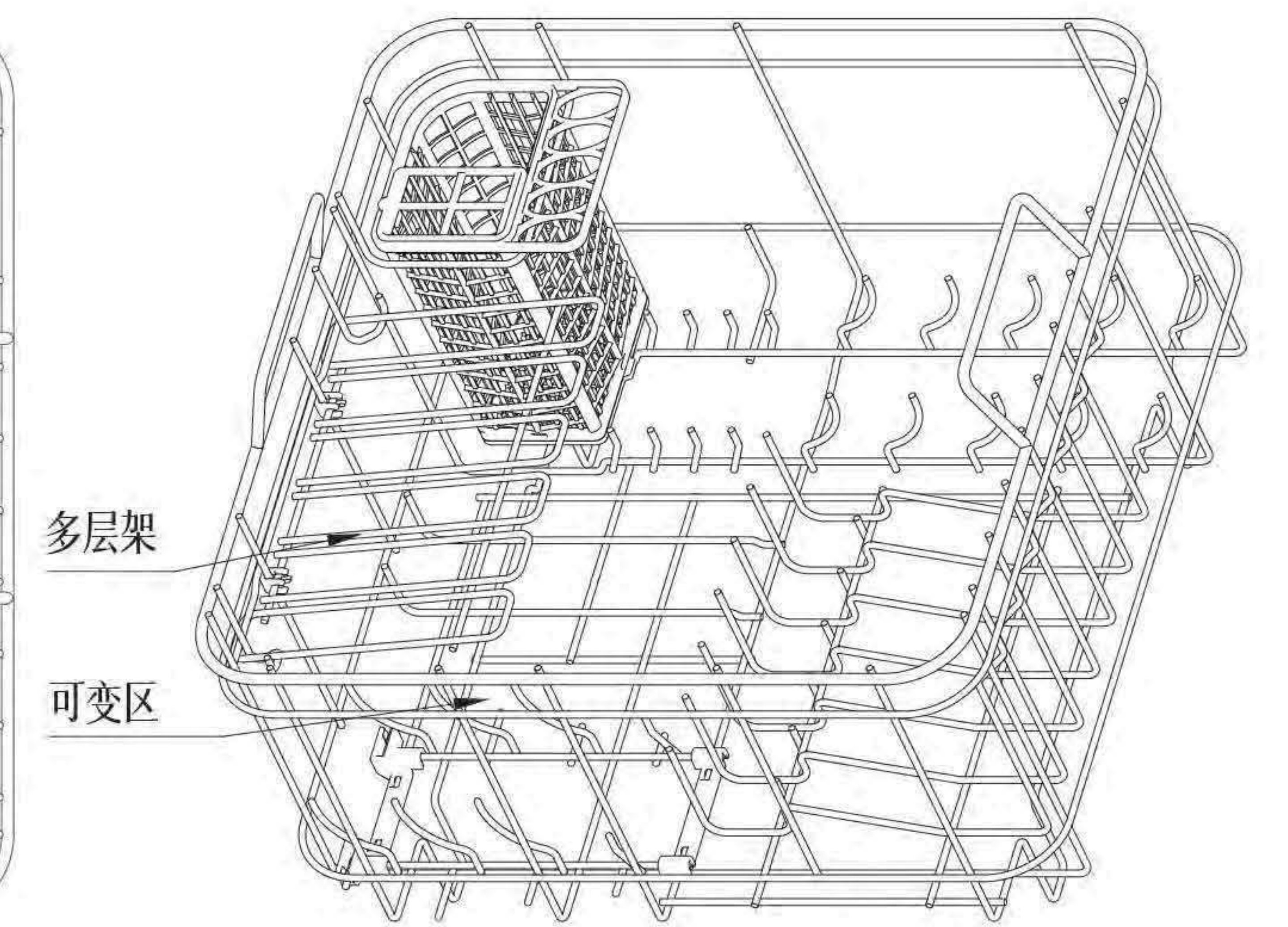
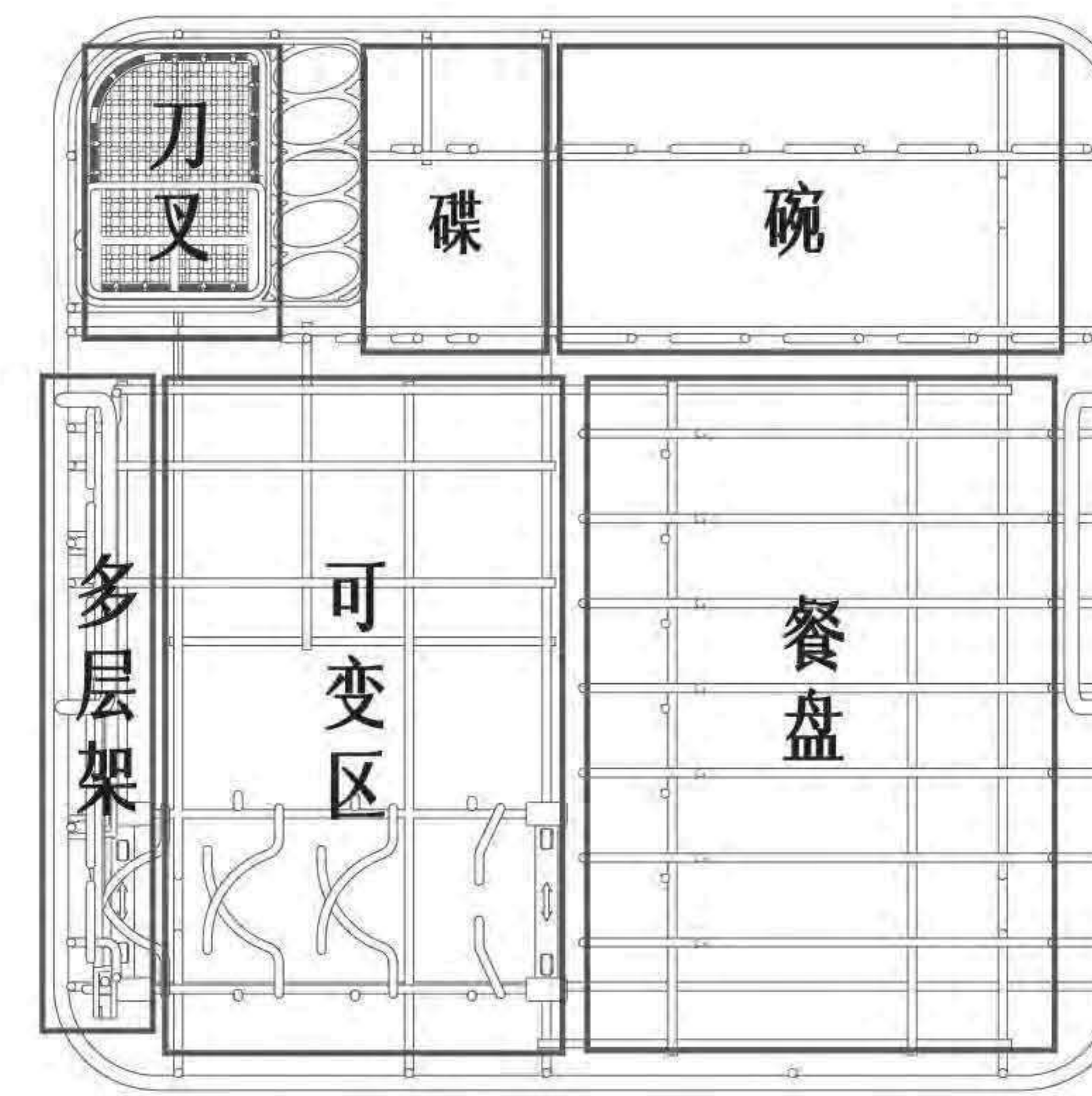

请注意：
为确保更好的洗涤效果，请将餐碟口的朝向，和箭头保持一致。

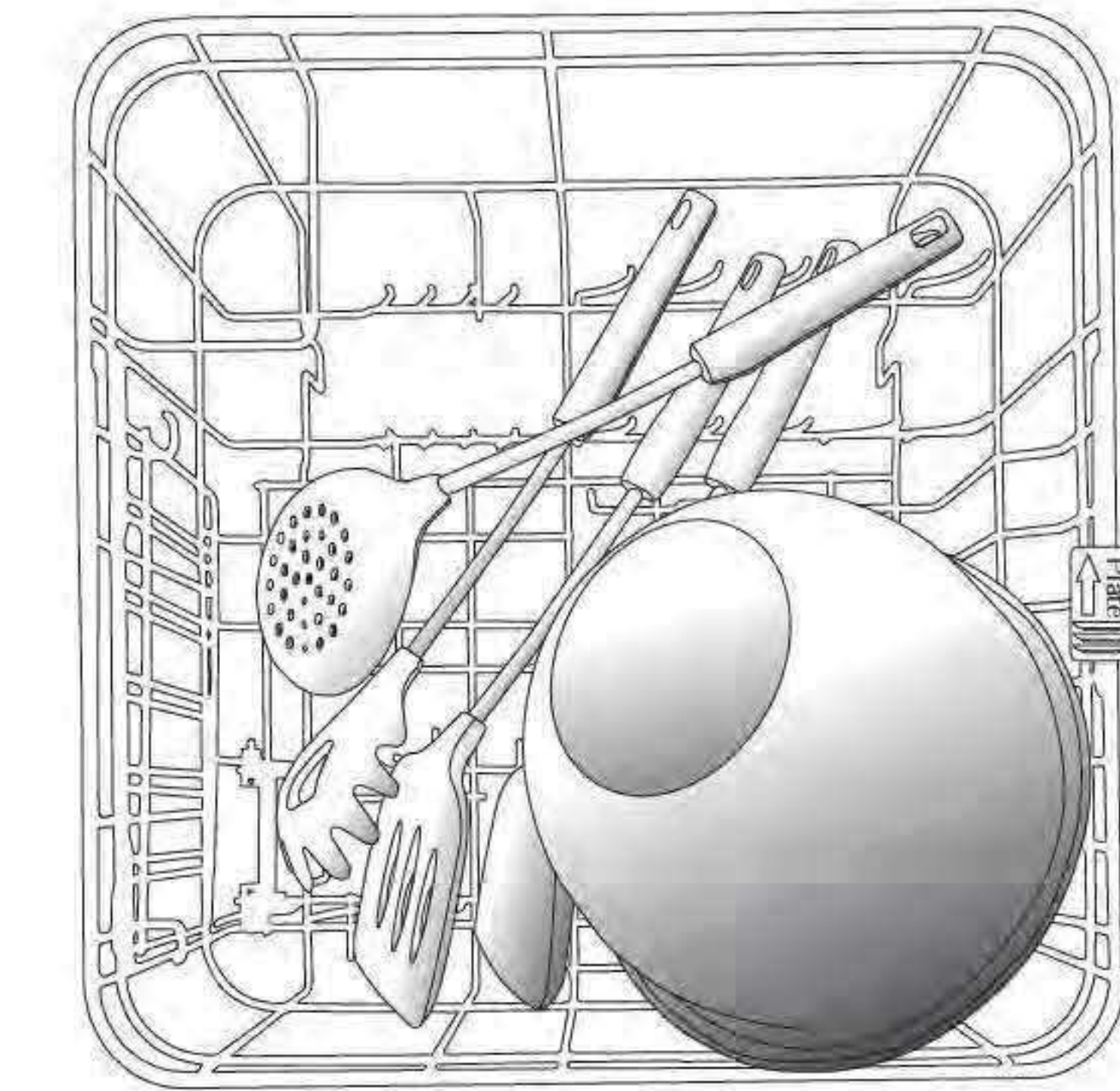
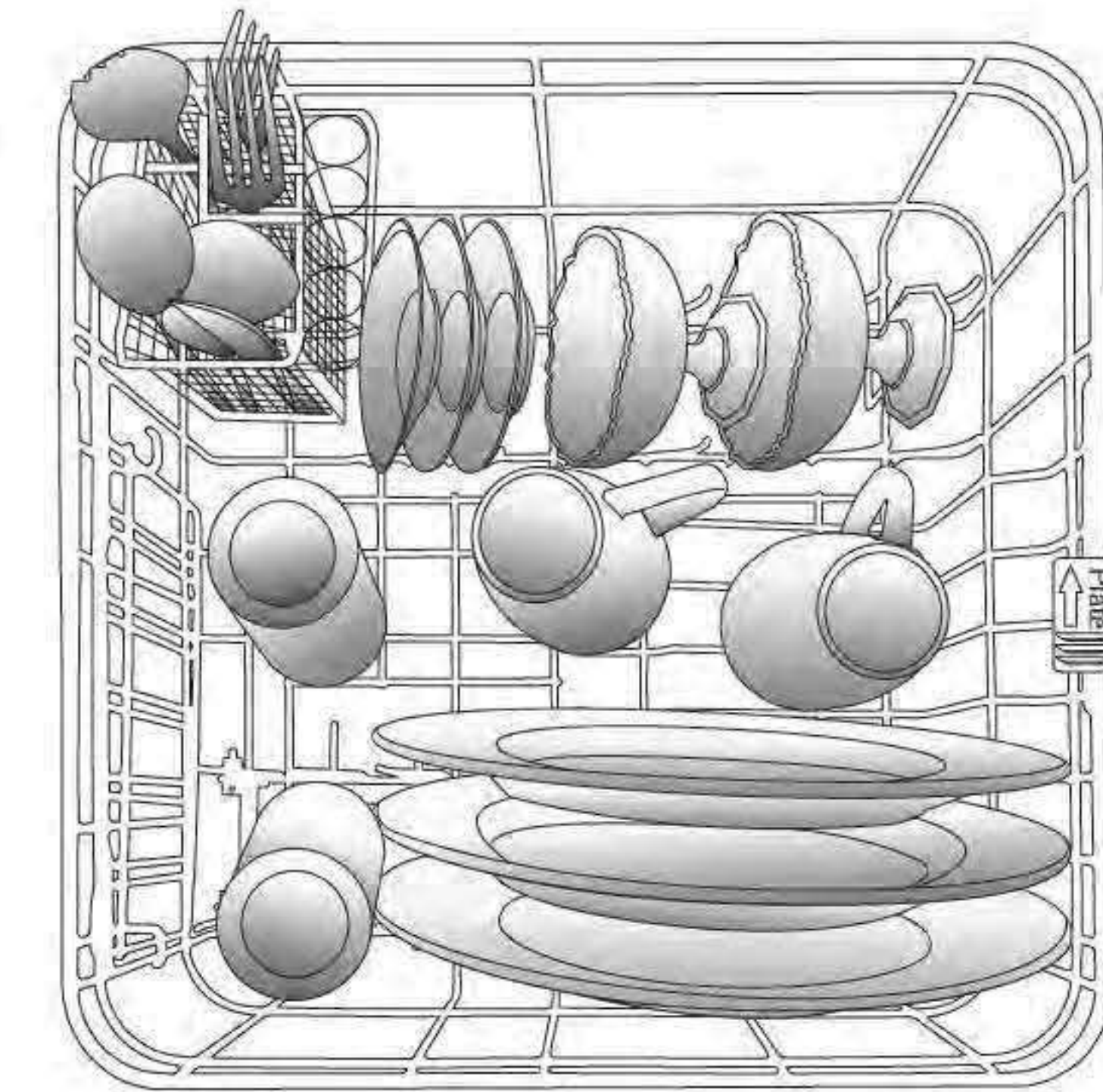

餐具摆放示意

餐具摆放说明：

1. 不要让酒杯等易碎物品触碰其它餐具。
2. 餐具放置时，避免餐具叠在一起，影响清洗效果。
3. 餐具较少时，间隔放置餐具有助于提升清洗效果。
4. 餐具放置时，请确保勺子类餐具的手柄不会从碗架底部伸出，以免阻挡喷淋臂的正常旋转，影响清洗效果。
5. 关门时请确保餐具或刀叉、筷子等不会顶门，以免门变形或者碗碟、刀叉、筷子等洗不干净。

可清洗餐具/材料

餐具和材料	是否可清洗	餐具及材料	是否可清洗
铝	是	不锈钢	是
一次性铝	否 它的材料会脱落附着在其它餐具上	纯银	是
瓶子和罐子	否 标签有胶, 会堵塞喷淋臂, 不利于洗涤	锡	否 会腐蚀生锈
铸铁	否 会生锈	木质象牙类	否 未经处理的木质会产生扭曲、裂纹
陶瓷	是	空心手柄 刀具	否 刀具里粘合剂在高温水的作用下会松脱
水晶	是	铜、青铜	否 在高温水和洗涤剂作用下会变形和变色
金	否 会变色		
玻璃	是		
一次性塑料	否 不能承受高温水和洗涤剂		
高温塑料	是		

注: 如果是其它特殊材料, 请咨询当地售后服务中心。

日常清理

1. 打开门体, 清除门体上残留的污垢。
2. 清洁槽体四壁和壁角, 可以适当的加入洗涤剂。
3. 逆时针旋转移除滤篮, 倾倒残渣并清洗。
4. 逆时针旋转移除喷淋臂并清洗。
5. 拿下过滤网板并清洗。
6. 清洗槽体底部。
7. 清理后请将各零部件按原位置安装, 并检查是否安装到位。

拆洗滤篮:
逆时针旋转移除滤篮,
倾倒残渣并清洗滤篮。

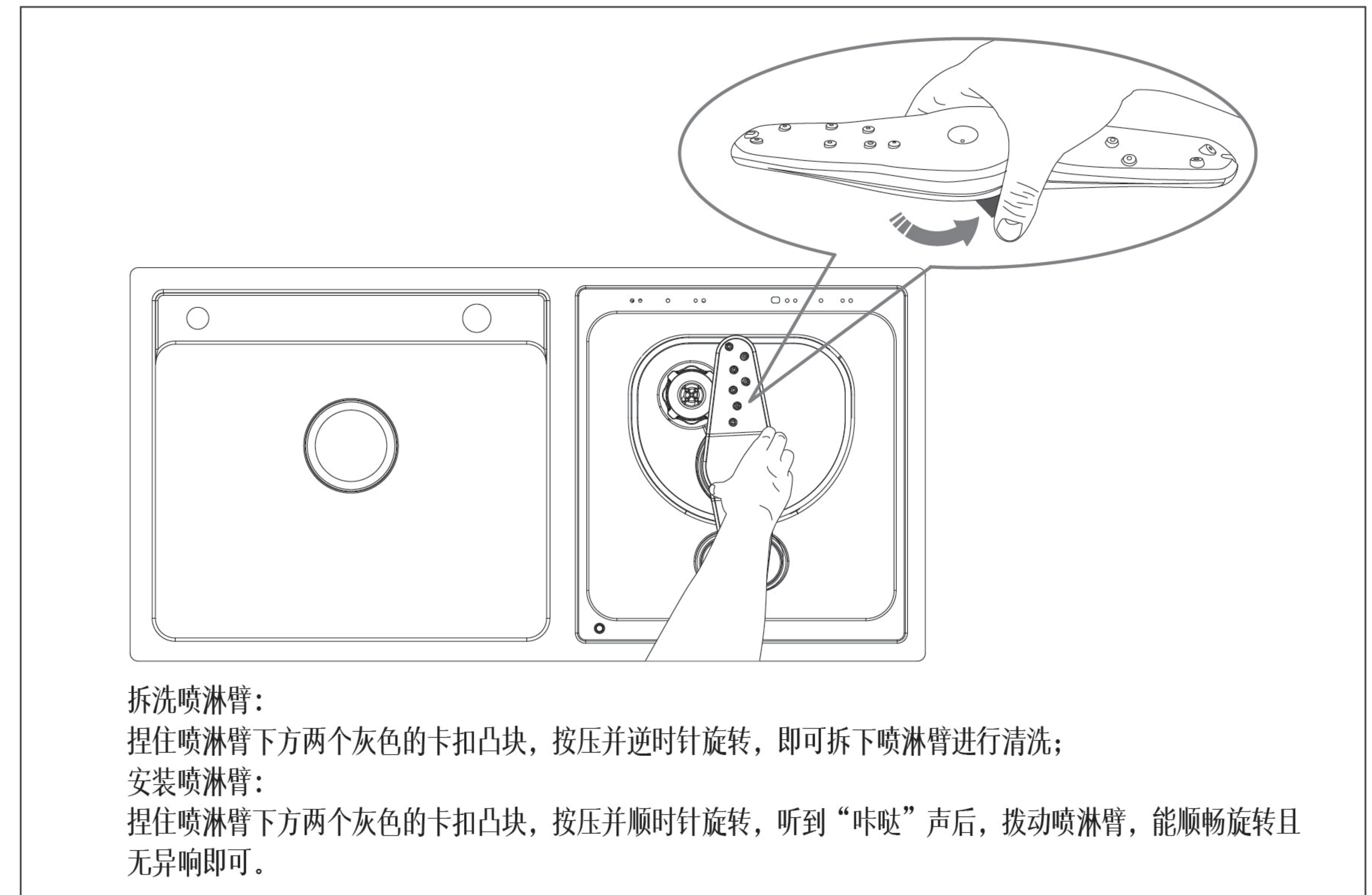
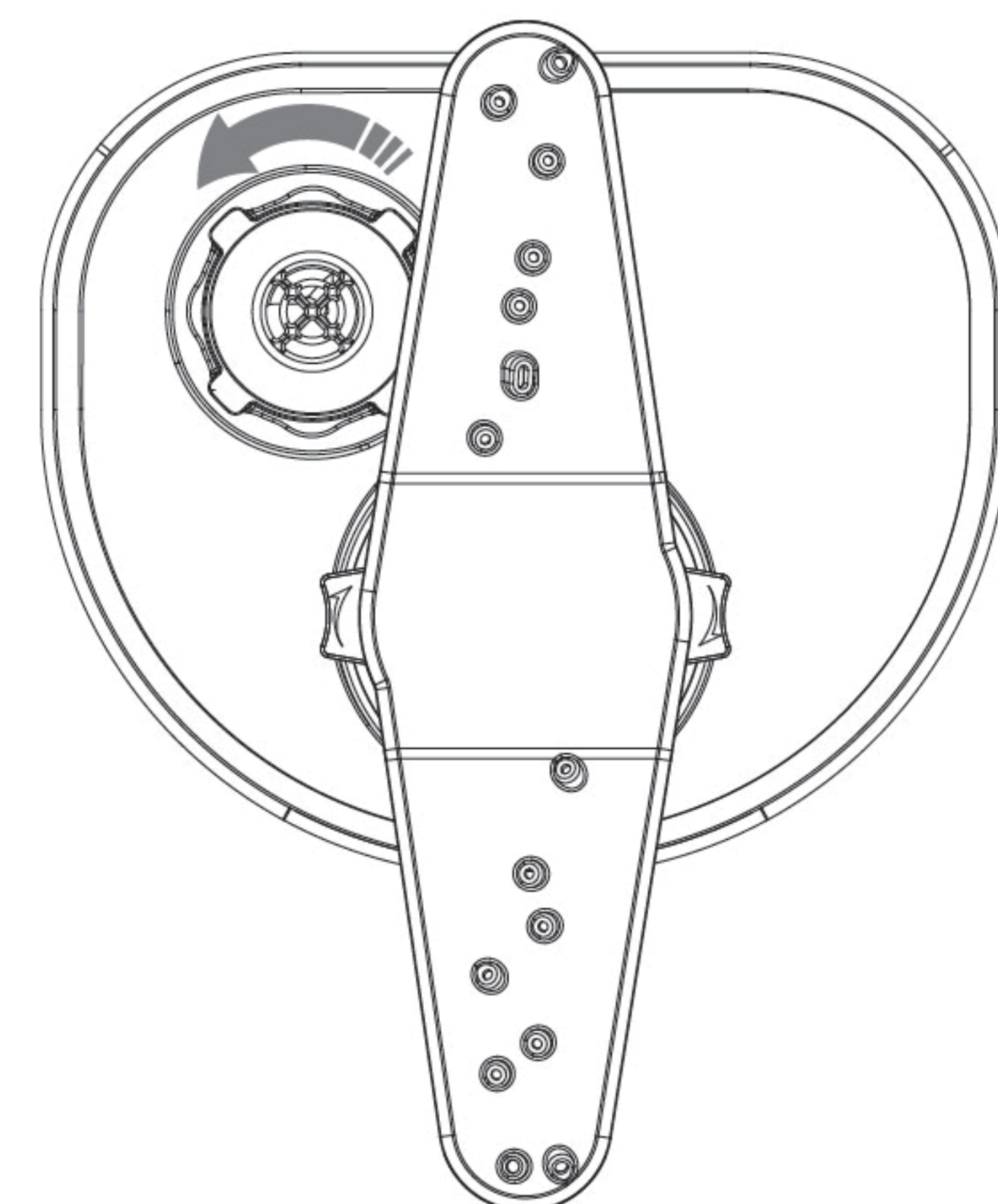

拆洗喷淋臂:

捏住喷淋臂下方两个灰色的卡扣凸块, 按压并逆时针旋转, 即可拆下喷淋臂进行清洗;

安装喷淋臂:

捏住喷淋臂下方两个灰色的卡扣凸块, 按压并顺时针旋转, 听到“咔哒”声后, 拨动喷淋臂, 能顺畅旋转且无异响即可。

保养建议

1. 清洁门封条时请勿使用洗涤剂。门封条可能会因为日久而穿孔或者裂开, 如出现此情况, 请及时更换新的门封条。
2. 面板和门体玻璃的清洁:
可以用热水和少量清洗剂进行手动清洗, 用海棉布拭抹, 清洁后用软布抹干。不要用百洁布、金属丝状物等摩擦, 以免刮伤表面。
3. 不锈钢槽体的清洁:

304不锈钢槽体的日常养护技巧

水槽洗碗机采用304不锈钢槽体, 请注意保护谨防划伤!

1. 如果您是新装修的用户, 可以在槽体外观涂一层不锈钢防锈油, 避免装修过程中的金属碎屑产生浮锈。此外, 假如长期不用水槽洗碗机, 也可用一层不锈钢防锈油涂刷在槽体上, 以保护槽体。
2. 经常清洗槽体, 采用中性清洁剂, 并用清水完全清洁干净。
清洁过程要轻柔, 避免用钢刷或粗糙的刷子。洗净后用海绵或抹布擦干。
3. 不要把柠檬、酱汁、泡菜、芥末或其余富含盐分的或带侵蚀性的食物长时间置于槽体内及面板上, 以防止其腐蚀槽体。
4. 尽量避免槽体与强力漂白粉、家用化学品和肥皂长期的接触。
5. 尽量避免刀叉、炊具等尖锐坚硬的器皿撞击水槽, 以防止刮花、划伤或碰凹槽体外观。
6. 不要把低碳钢或铸铁炊具长期放于槽体内, 也不要钢丝球、橡胶洗碗片、湿润的洗碗海绵或其余清洁垫置于槽体中, 避免长此以往形成“浮锈”、“霉斑”等。
7. 若槽体出现“浮锈”、“霉斑”等, 可用牙膏涂在锈迹和斑点处, 用抹布清洗干净即可, 不要用百洁丝、打磨片或打磨材料来清洁槽体。

4. 喷淋臂和渣篮逆时针旋转即可取出，可用清水进行清洗。
5. 清洗后请不要让控制面板上有积水，会影响正常使用。
6. 每次清洗后，渣篮内的食物残渣要及时清理，否则会影响下次清洗效果，并产生异味。
7. 若发现功能槽有结垢现象（如槽体、加热盘、碗架等表面发白等），请使用食醋、苏打粉对槽体进行清洗。
8. 每隔一定的时间或长期不用后重新使用，建议进行腔体自清洁。

故障排除

如果您在使用中发现异常状况，请停止使用，切断产品电源，并检查以下内容：

故障现象	可能原因	检修方法
有异响	喷淋臂没有安装到位	重新拆装喷淋臂
	餐具没有按指定要求放置，导致餐具碰撞	检查餐具摆放是否符合标准要求
显示屏不亮，按键无反应	未接通电源	检查电源连接是否正常
有异味	未清洁	请按日常清理步骤进行维护保养
功能槽无法排水	意外碰触模式键，导致牵引阀关闭	关闭状态下，请长按“开始/暂停”键2秒打开牵引阀
门体不能开启	洗碗机使用中电源切断	打开下柜，找到白色门弦绳，往下拉的同时，用一字螺丝刀轻轻撬动门体扶手处
显示代码E1	门体未关住	轻轻往下按压门体
	门锁故障	请咨询方太公司客服
显示代码E2	水压太小	确保进水阀完全打开
		请咨询方太公司客服
显示代码E8	漏水，或门体密封性不好	确保进水阀完全打开
		请咨询方太公司客服
显示其它代码	/	请咨询方太公司客服

客户服务

方太所有洗碗机产品，享有1年全保，包含零部件和人工费用，洗碗机电机享有额外4年零件有限质保。

以下情况不在保修条款覆盖范围内：

- 免费上门，确认安装条件，或指导如何使用产品等。
- 用户自行运输、安装或维护不当。
- 因产品被滥用、误用、修改或用于其他目的或商业用途，导致产品故障。
- 未按照说明书要求进行清洁保养，导致损伤。
- 事故、火灾、洪水或不可抗力等因素造成的产品损坏。
- 超出正常使用条件，强行使用本产品造成的故障和损伤，如电压不符合。
- 购买凭证和产品的保修注册信息不符。

本保修范围覆盖在美国购买产品的原始购买者以及任何继任所有者。如产品位于方太公司授权服务不可到达之处，则需要由您负责支付相应交通费用，或者您可能需将产品带至授权服务处，进行维修保养。

- 如果您已购买方太水槽洗碗机产品，请尽快进行产品注册。以便在您有需要时，我们可及时与您沟通并提供服务。您有如下两种方式进行产品注册：
 - 本产品包装内附有纸质版产品注册卡，您可填写信息后邮寄至方太公司
 - 登录方太官方网站进行产品注册：
<https://us.fotileglobal.com/pages/product-warranties-registration>
- 如果您已购买方太水槽洗碗机产品，在沟通时告知该产品型号、序列号，可以帮助我们更好地为您服务。

您可以在图示A位置找到以上信息：

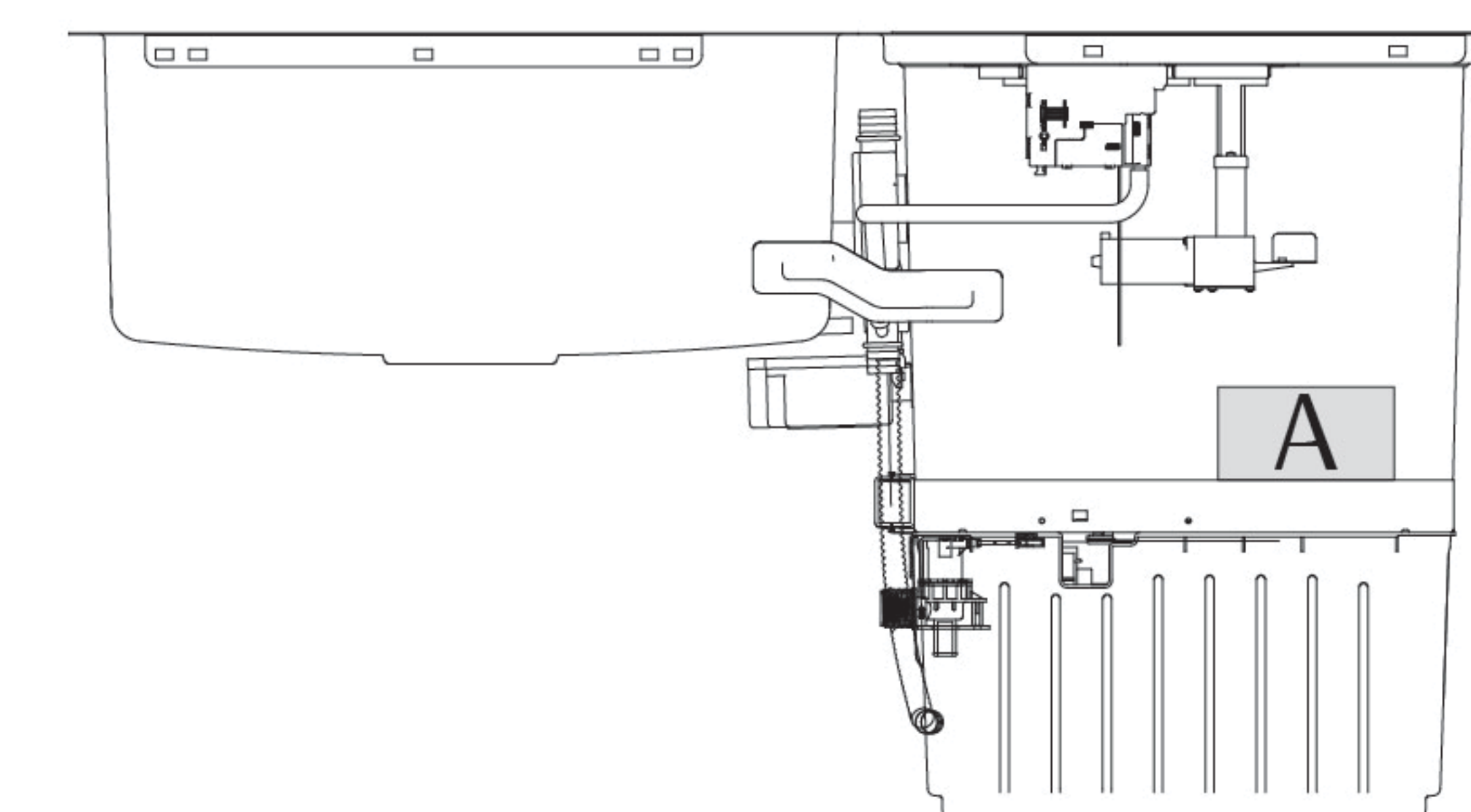

- 如果您需要购买配件，您可以有如下选择：
 - 访问方太官方商城：<https://shop.fotileglobal.com/>，进行了解和购买
 - 致电方太公司免费中英文服务热线：1(888)-315-0366，进行咨询和购买
 - 联系方太公司官方授权门店（可通过访问方太官网 <https://us.fotileglobal.com> 查询您所在城市的授权门店），进行咨询和购买
- 如果您需要其它服务，您可通过以下方式联系方太公司：
 - 免费中英文热线电话：1(888)315-0366
 - 客服邮箱：serviceusa@fotile.com（请您留下方便日间联系的电话号码）
 - 收信地址：6 Campus Dr, Suite 210, Parsippany, NJ 07054

爆炸图

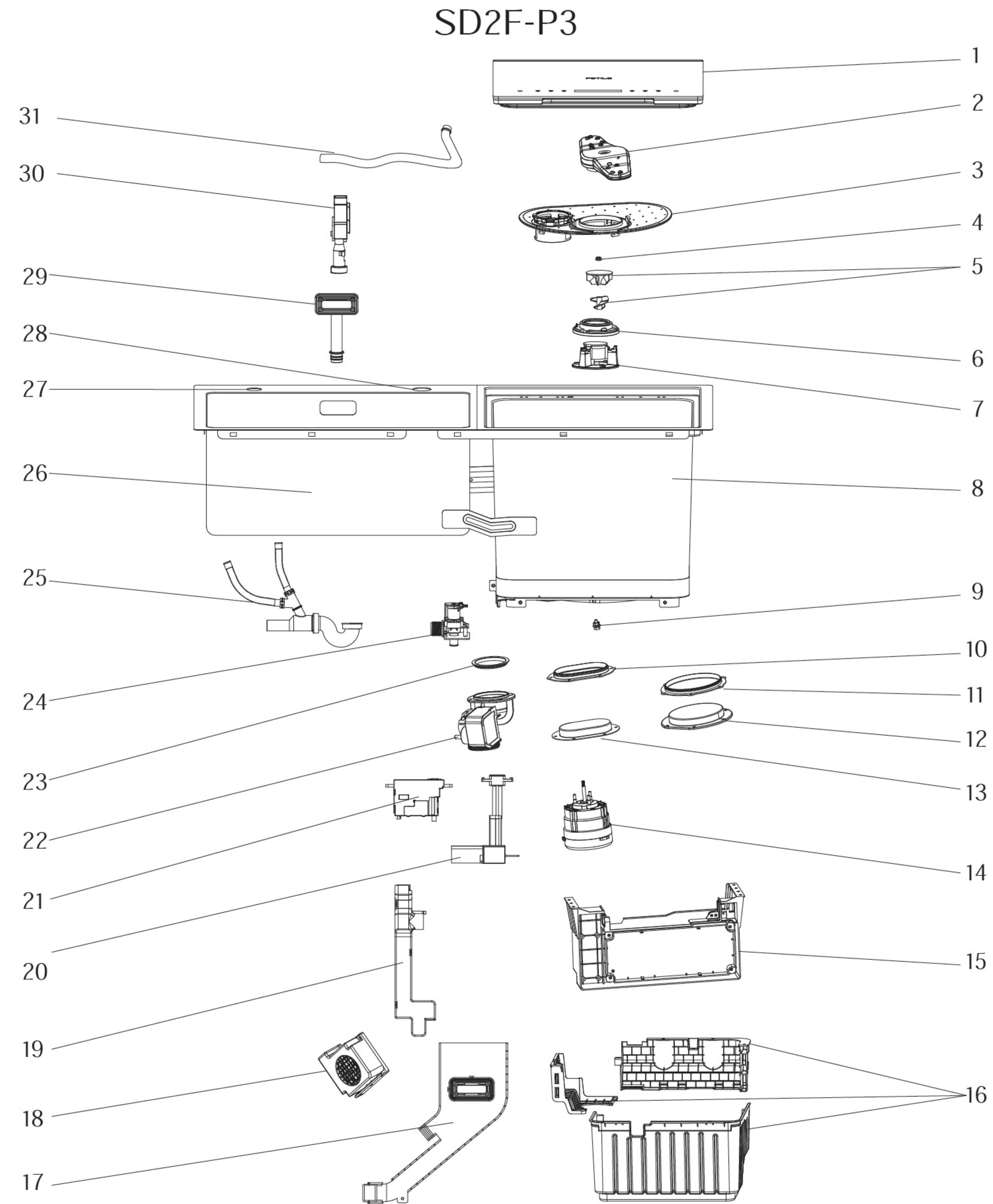

- | | |
|---------------|---------------|
| 1. 门体 | 17. 进气座组件 |
| 2. 喷淋臂 | 18. 风扇组件 |
| 3. 过滤网板 | 19. 走线支架 |
| 4. 叶片锁紧螺母 | 20. 顶门电机 |
| 5. 叶轮 (上、下) | 21. 门锁 |
| 6. 电机上盖 | 22. 牵引阀 |
| 7. 导流座 | 23. 牵引阀密封圈 |
| 8. 功能槽槽体 | 24. 进水阀 |
| 9. 温度传感器 | 25. 功能槽下水接管组件 |
| 10. 超声波换能器密封圈 | 26. 水槽槽体 |
| 11. 加热盘密封圈 | 27. 皂液器安装孔 |
| 12. 加热盘 | 28. 水龙头安装孔 |
| 13. 盖板 | 29. 水槽溢水组件 |
| 14. 电机 | 30. 功能槽溢水组件 |
| 15. 电器盒 | 31. 电源线 |
| 16. 底盖 | |

SD2F-P3L

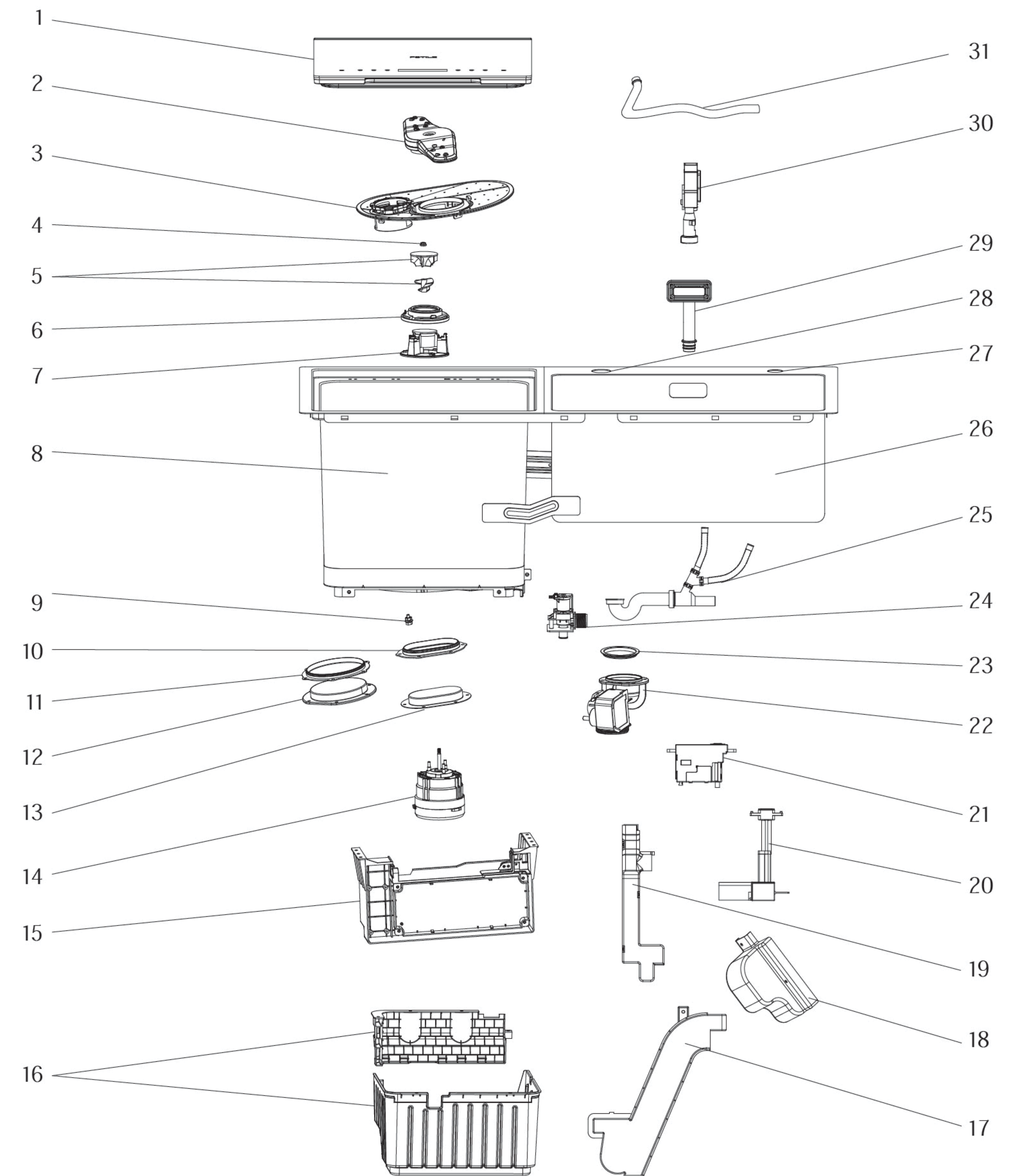

- | | |
|---------------|---------------|
| 1. 门体 | 17. 进气座组件 |
| 2. 喷淋臂 | 18. 风扇组件 |
| 3. 过滤网板 | 19. 走线支架 |
| 4. 叶片锁紧螺母 | 20. 顶门电机 |
| 5. 叶轮 (上、下) | 21. 门锁 |
| 6. 电机上盖 | 22. 牵引阀 |
| 7. 导流座 | 23. 牵引阀密封圈 |
| 8. 功能槽槽体 | 24. 进水阀 |
| 9. 温度传感器 | 25. 功能槽下水接管组件 |
| 10. 超声波换能器密封圈 | 26. 水槽槽体 |
| 11. 加热盘密封圈 | 27. 皂液器安装孔 |
| 12. 加热盘 | 28. 水龙头安装孔 |
| 13. 盖板 | 29. 水槽溢水组件 |
| 14. 电机 | 30. 功能槽溢水组件 |
| 15. 电器盒 | 31. 电源线 |
| 16. 底盖 | |