

FOTILE

USER'S HANDBOOK

Please read this instruction manual carefully before using

BUILT-IN OVEN

KSS7002A
KSG7003A

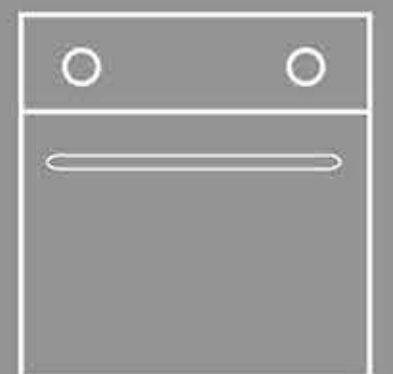

CONTENTS

Warning and Safety Instructions	2
Caring for the Environment	5
Guide to the Appliance	5
Packing List	5
Parts Name	6
Technical Data	7
Features	7
Cleaning and Heating up for the First Time	7
Controls	8
Function set up - KSS7002A	8
Function set up - KSG7003A	12
Temperature Set up	13
Oven Interior Light	13
Child Lock	14
Clock/Timer	14
Programming Cooking Durations	17
Oven Functions	19
Oven Functions	19
Cooking Suggestions	20
Cleaning and Care	21
Problem Solving Guide	24
Installing the Oven	24
Electrical Connection	24
Installing the Oven	25

Warning and Safety Instructions

This appliance conforms to current safety requirements. Inappropriate use can, however, lead to personal injury and damage to property. To avoid the risk of accidents and damage to the appliance, please read these instructions carefully, before using it for the first time. They contain important notes on installation, safety, use and maintenance. Keep these instructions in a safe place and ensure that new users are familiar with the content. Pass them on to any future owner.

■ Correct application

1. The appliance is intended for domestic use to cook food, and in particular to bake, roast, grill, defrost and dry fruit. Any other usage is at the owner's risk and could be dangerous. The manufacturer cannot be held liable for damage resulting from incorrect or improper use or operation.
2. This oven is not intended for use by persons (including children) with reduced physical, sensory or mental capabilities, or lack of experience and knowledge, unless they have been given supervision or instruction concerning its use by a person responsible for their safety.
3. **WARNING-** Accessible parts may become hot during use. To avoid burns young children should be kept away.

■ Safety with children

1. Children should be supervised to ensure that they do not play with the appliance.
2. Older children may only use the oven when its operation has been clearly explained to them and they are able to use it safely, recognizing the dangers of misuse.
3. Great care should be taken to ensure that children do not touch the appliance when it is being used. Children's skin is far more sensitive to high temperature than that of adults. External parts of the oven such as the door glass, and the vent will become quite hot.
4. During use, the appliance becomes hot. Care should be taken to avoid touching heating elements inside the oven.

■ Technical safety

1. Installation, maintenance and repairs may only be carried out by a suitably qualified and competent person in accordance with current national and local safety regulations. Repairs and other work by unqualified persons could be dangerous. The manufacturer cannot be held liable for unauthorized work.
2. Before installation, check the appliance for visible signs of damage. Under no circumstances should you use a damaged appliance. A damaged appliance could be dangerous.
3. The electrical safety of this appliance can only be guaranteed when continuity is complete between it and an effective earthing system. It is most important that this basic safety requirement is present and tested regularly, and where there is any doubt the household wiring system should be inspected by a qualified electrician. The manufacturer cannot be held liable for the consequences of an inadequate earthing system (e.g. electric shock).
4. Before connecting the oven to the mains supply, make sure the rating on the data plate corresponds to the voltage and frequency of the on-site supply. Consult a competent person if in doubt.
5. **WARNING:** Accessible parts may become hot during use, young children should be kept away.
6. Do not connect the appliance to the mains electricity supply by a multi-socket unit or an extension lead. These do not guarantee the required safety of the appliance (e.g. danger of overheating).

7. For safety reasons, this appliance may only be used when it has been built in.
8. Never open the housing of the appliance. Tampering with electrical connections or components and mechanical parts is highly dangerous to the user and can cause operational faults.
9. While the appliance is under guarantee, repairs should only be undertaken by a service technician authorized by the manufacturer. Otherwise the guarantee will be invalidated.
10. During installation, maintenance and repair work, the appliance must be switched off.
11. Faulty components must only be replaced by genuine FOTILE original spare parts. The manufacturer can only guarantee the safety of the appliance when FOTILE replacement parts are used.
12. If the supply cord is damaged, it must be replaced by a FOTILE approved service technician to avoid a hazard.
13. In countries where there are areas which may be subject to infestation by cockroaches or other vermin, pay particular attention to keeping the appliance and its surroundings in a clean condition at all times. Any damage which may be caused by cockroaches or other vermin will not be covered by the guarantee.
14. Warning: Ensure that the appliance is switched off before replacing the lamp to avoid the possibility of electric shock.

■ Correct use

Caution: Danger of burning. High temperature are produced by the oven.

1. Use oven gloves etc. when placing food in the oven, turning or removing it and when adjusting oven shelves etc. in a hot oven. Be very careful that you do not burn yourself on the top heating / grill element.
2. Never leave the appliance unattended when you cooking with oil or fats, as these are a fire hazard if allowed to overheat.
3. Do not use the oven to finish drying flowers or herbs. Fire hazard!
4. If using alcohol in your recipes, high temperature can cause the alcohol to vaporize and even to ignite on the hot heating elements. Alcohol should be burnt off before the dish is placed in the oven to avoid this danger.
5. Cover any food which is left in the oven to be kept hot. Any moisture in the food could lead to corrosion damage in the oven. This also prevents the food from drying out.
6. If you wish to complete a cooking process using the residual heat in the oven, leave the function selector at the position set and turn the temperature selector to the lowest setting. Do not switch the appliance off until the food has been removed. Increased moisture in the oven could cause condensation to form, which could lead to corrosion in the oven compartment and damage to the control panel, worktop and surrounding kitchen furniture.
7. Never line the floor of the oven with aluminium foil. This would cause concentrations of heat which could cause damage to the floor of the oven. For this reason do not place a dish, tin, or baking tray directly on the oven floor.
8. Never add water to food on a hot baking tray or directly onto food in a hot oven. The steam created could cause serious burns or scalding and the sudden change in temperature can damage the enamel.
9. Always ensure that food is suitably cooked or reheated. Some foods may contain micro-organisms which are only destroyed by thorough cooking at temperature over 70 °C for a minimum of 10 minutes. Therefore when cooking or reheating foods, e.g. poultry, it is particularly important that food is fully cooked through. If in doubt select a longer cooking or reheating time. It is important that the heat is allowed to spread evenly throughout the food being cooked. This can be achieved by stirring and/or turning the food during cooking.

10. If using plastic containers for cooking, they must be declared by the manufacturer as being suitable for use in an oven. Other types of plastic containers melt at high temperatures, and could damage the oven.
11. Do not heat up unopened tins or jars of food in the oven. Pressure can build up and they may explode, resulting in injury or damage.
12. Do not push pots and pans around on the oven floor, as this could damage the surface.
13. Do not lean or sit on an open oven door, or place heavy items on it. The oven door can support a maximum load of 15 kg. Make sure that nothing gets trapped between the door and the oven compartment. This could damage the oven.
14. Do not use the appliance to heat up the room. Due to the high temperature radiated, objects left near the oven could catch fire.
15. Please make sure the door is closed when the oven is heating.
16. Proper Installation - Be sure your appliance is property installed and grounded by a qualified technician.
17. Never Use Your Appliance for Warming or Heating the Room.
18. Do Not Leave Children Alone - Children should not be left alone or unattended in area where appliance is in use. They should never be allowed to sit or stand on any part of the appliance.
19. Wear Proper Apparel - Loose-fitting or hanging garments should never be worn while using the appliance.
20. User Servicing - Do not repair or replace any part of the appliance unless specifically recommended in the manual. All other servicing should be referred to a qualified technician.
21. Storage in or on Appliance - Flammable materials should not be stored in an oven or near surface units.
22. Do Not Use Water on Grease Fires - Smother fire or flame or use dry chemical or foam-type extinguisher.
23. Use Only Dry Potholders - Moist or damp potholders on hot surfaces may results in burns form steam. Do not let potholder touch hot heating elements. Do not use a towel or other bulky cloth.
24. Use Care When Opening Door - Let hot air or steam escape before removing or replacing food.
25. Do Not Heat Unopened Food Containers - Build-up of pressure may cause container to burst and result in injury.
26. Keep Oven Vent Ducts Unobstructed.
27. Placement of Oven Racks - Always place oven racks in desired location while oven is cool. If rack must be moved while oven is hot, do not let potholder contact hot heating element in oven.
28. DO NOT TOUCH HEATING ELEMENTS OR INTERIOR SURFACES OF OVEN - Heating elements may be hot even though they are dark in color. Interior surfaces of an oven become hot enough to cause burns. During and after use, do not touch, or let clothing or other flammable materials contact heating elements or interior surfaces of oven until they have had sufficient time to cool. Other surfaces of the appliance may become hot enough to cause burns - among these surfaces are (indentification of surfaces - for example, oven vent openings and surfaces near these openings, oven doors, and windows of oven doors).
29. This product contains chemicals known to the State of California to cause cancer, and birth defects or other reproductive harm. For more information, please go to: www.P65Warnings.ca.gov

■ Accessories

Only use genuine FOTILE spare parts and accessories with this appliance. If spare parts or accessories from other manufacturers are used, this will invalidate the guarantee, and FOTILE cannot accept liability. The manufacturer cannot be held liable for damage caused by non-compliance with these Warning and Safety instructions.

Caring for the Environment

Disposal of the packing material

The transport and protective packing has been selected from materials which are environmentally friendly for disposal and can normally be recycled.

Ensure that any plastic wrappings, bags etc. are disposed of safely and kept out of the reach of babies and young children. Danger of suffocation!

Rather than just throwing these materials away, please ensure they are offered for recycling.

Disposal of your old appliance

Electrical and electronic appliances often contain materials which, if handled or disposed of incorrectly, could be potentially hazardous to human health and to the environment. They are, however, essential for the correct functioning of your appliance. Please do not therefore dispose of it with your household waste.

Please dispose of it at your local community waste collection / recycling centre or contact your dealer for advice. Ensure that it presents no danger to children while being stored for disposal. It should be unplugged or disconnected from the mains electricity supply by a competent person.

Guide to the Appliance

Packing list

1. Take the packing material out of oven, and examine carefully whether the oven is intact.
 - a. Is the oven impacted or pressed by heavy object?
 - b. Is the oven door flat and switch unhindered?
 - c. Is there any scarcity or shatter in accordance with packing list?
 - d. Is the power cord damaged or loose?

If you find any one of the above happens, please contact FOTILE authorized service people.

2. Packing list

The following accessories are supplied with this oven.

Item	Quantity	Picture
Electrical built-in oven	1 Pcs	
Handbook	1 Pcs	
Tray	1 Pcs	

Item	Quantity	Picture
Grill/Tray clip	1 Pcs	
Grill grid	1 Pcs	
Woodscrew & Shim (for installation)	4 Pcs	

Parts name

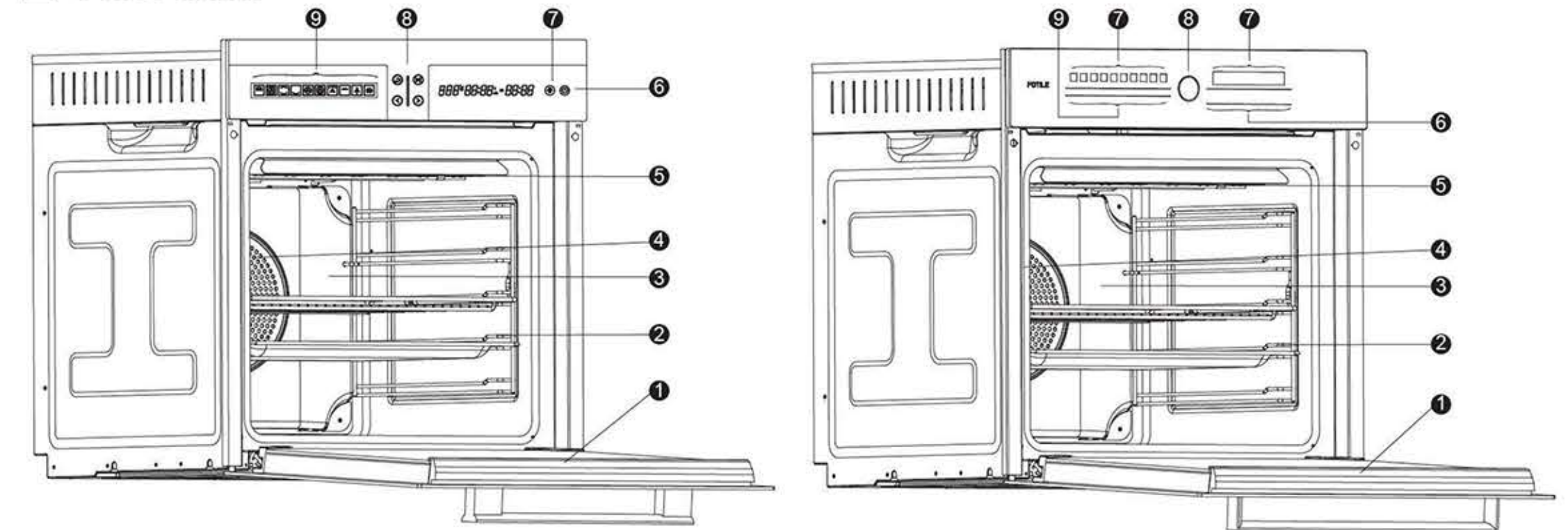

KSS7002A

KSG7003A

KSS7002A		KSG7003A	
1. Door	6. Power	1. Door	6. Touch keys for: Clock/Timer, Child lock, Minus, OK, Alarm, Light, Plus
2. The right support	7. Lamp key	2. The right support	7. Touch keys for: Return, Confirmation/Pause, Reduce, Increase
3. Air inlet back panel of fan	8. Touch keys for: Return, Confirmation/Pause, Reduce, Increase	3. Air inlet back panel of fan	8. Power
4. The left support	9. Cooking duration has been set, The oven is working, The started time has been set	4. The left support	9. Function touch keys
5. Top heat / grill element(inside)		5. Top heat / grill element(inside)	



Please refer to the different description according to the actual oven you purchased.

Technical data

Model	KSS7002A	KSG7003A
Rating	240V 60Hz	240V 60Hz
Rated Power	3800W	3800W
Product Size(W x H x D)	23 7/16" x 23 7/16" x 21 3/4" (595X595X552mm)	23 7/16" x 23 7/16" x 21 3/4" (595X595X552mm)
Oven Capacity	2.47cu.ft.	2.47cu.ft.
Net Weight	88.2 lbs	88.2 lbs

Features

Oven controls

The oven controls are used for selecting the various cooking programmes for baking, roasting and grilling.

Appliances with a clock-timer also feature the following:

- Clock display
- Minute minder
- Timer to automatically switch cooking programmes off, or on and off.

Cooling fan

A cooling fan will come on automatically when a cooking programme is started. The cooling fan mixes hot air from the oven cavity with cool room air before venting it out through vents located between the appliance door and the control panel. The cooling fan will continue to run for a while after the oven has been switched off to prevent any humidity building up in the oven, on the control panel or on the oven housing unit. When the temperature in the oven has fallen sufficiently, the cooling fan will switch off automatically.

Cleaning and heating up for the first time

New ovens have a slight smell on first use and this will dissipate the smells before you use it to cook any food.

Before use, please

- remove any stickers from the floor of the oven, baking trays, rack etc.
- take all accessories out of the oven and wash them.
- wipe the oven out with a damp cloth first. By way any dust or bits of packaging that may have accumulated in the oven cavity during storage and unpacking will be removed.

Then heat the oven up once with nothing in it.

- Turn the function to .
- Use the temperature touch keys to set the highest temperature.
- Heat the empty oven up at least an hour. Please ensure that the kitchen is well ventilated during this operation. Close the doors to other rooms to prevent the smell spreading throughout the house.
- On models with a clock/timer, you can set this procedure to finish automatically, see the appropriate section.

Please wait until the oven has cooled down to room temperature. Then wipe out the oven cavity with a solution of hot water and a mild detergent and dry it thoroughly with a clean cloth. Leave the oven door open until the oven interior is completely dry.



Controls

Function set up - KSS7002A





1) Power on:

Press the “” touch key for 0.5 second; the power is on.

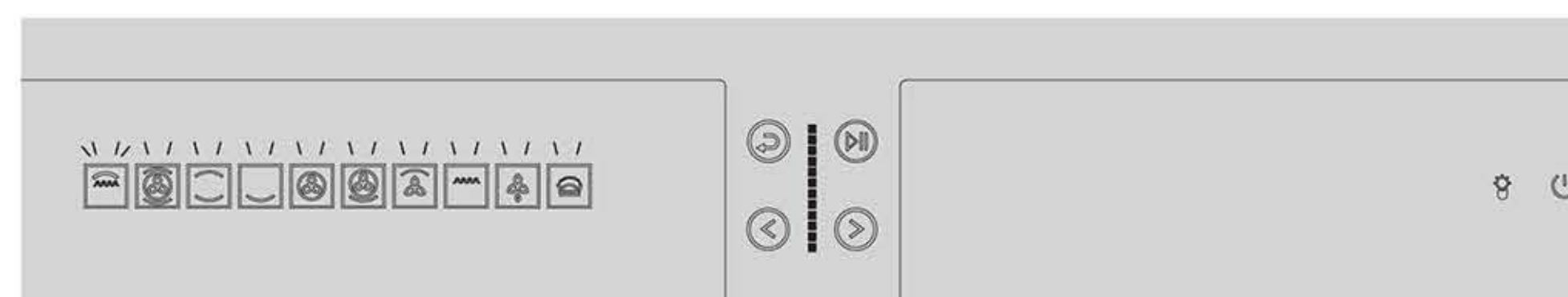
2) Oven setting:

- After the power is on, all the left area cursors of cooking mode are bright; enter into the cooking setting mode; at this time, the "Return" key “” and "Confirm" key “” are invalid.



- Press direction key “” or “” and the corresponding function cursor lights. The function of Return key “” and "Confirm" key “” resume.

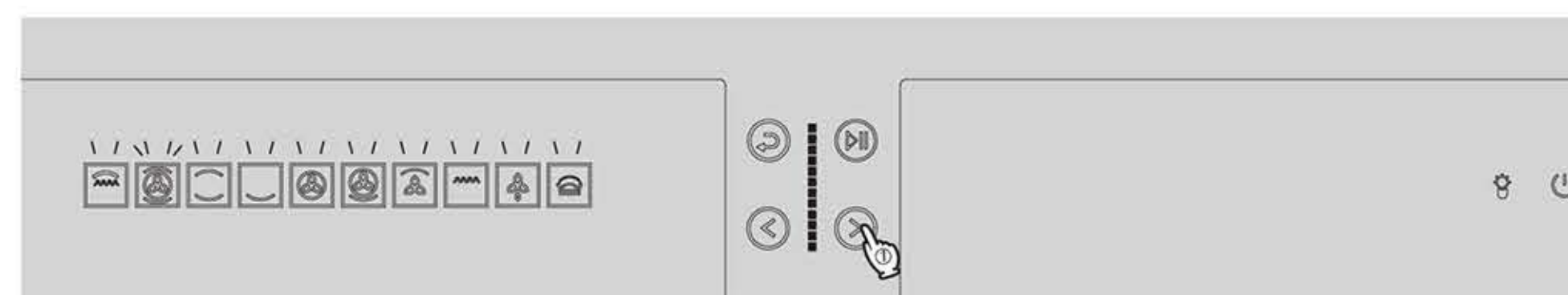

- Press the "Confirm" key “”, the selected mode cursor highlights and the other mode cursors go out.

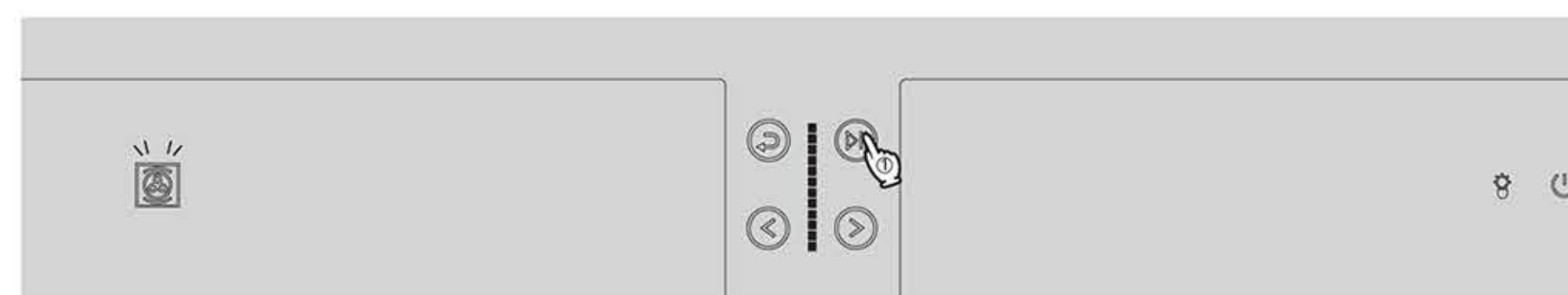

- After mode selection is completed, temperature (default display is “ 160°C ”) lights. Then enter into the cooking temperature setting mode.

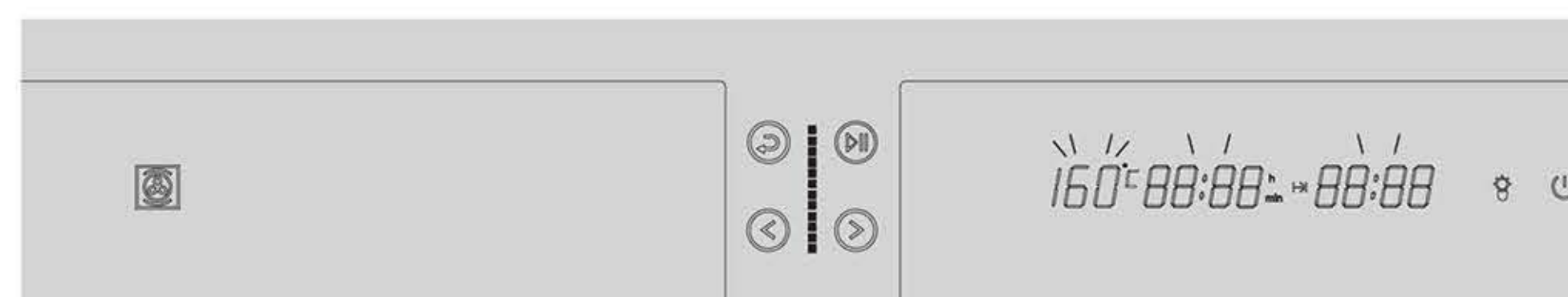

- Press direction key “<” or “>” to set the temperature (1°C one jump, Press it long, and the number will jump fast 5°C one jump). After the temperature is appropriate, press “▶▶”; (for example, we need to set the temperature at 170°C)

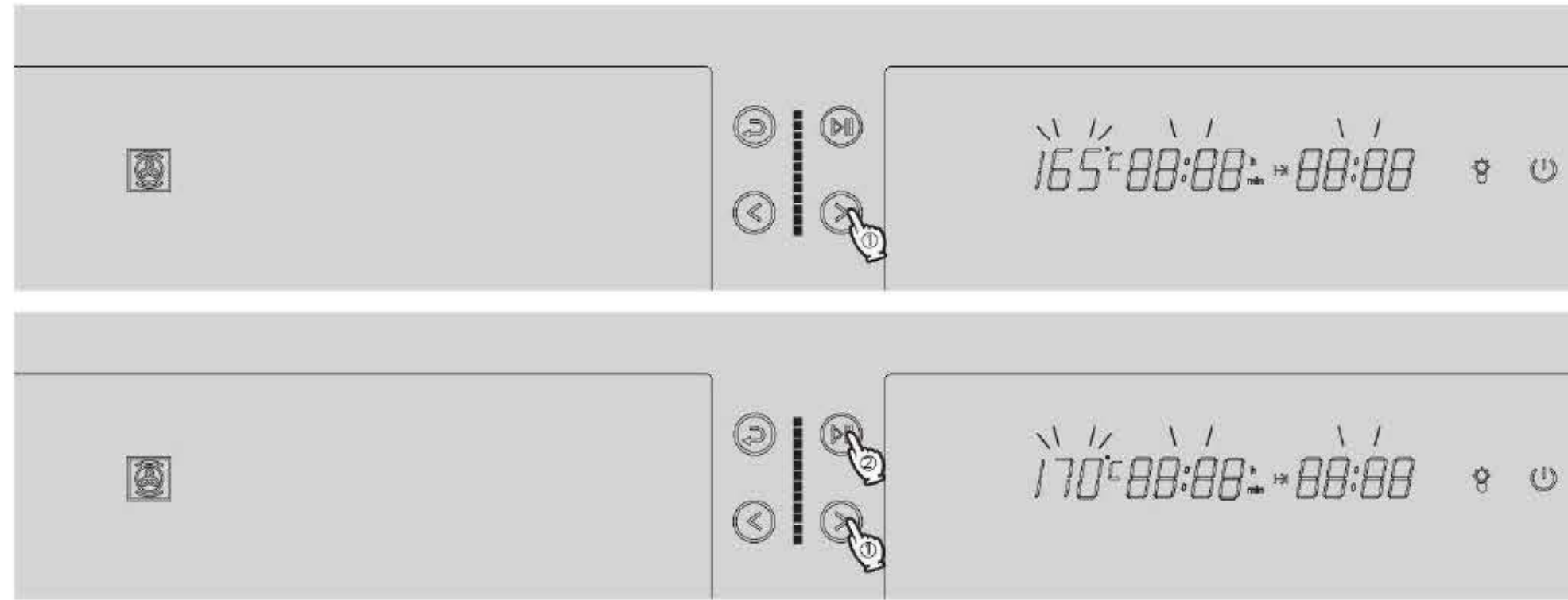

- After the temperature setting is completed, the cooking time (default display is 00:25) lights; the direction key “<” or “>” lights, entering into the cooking time setting mode. Press the direction key “<” or “>” to set hour and minute (one minute one jump) and the corresponding unit "h" and "min" light. Press it long, and the number will jump fast until the time is appropriate; then press "Confirm" key “▶▶” for confirmation, and the "h" and "min" will not light since then;

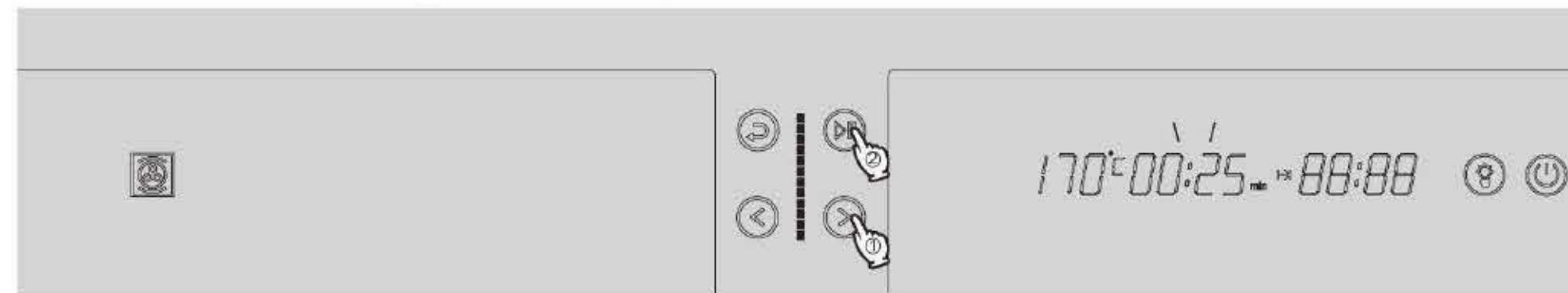

- Press direction key “<” or “>” to set the time (one minute one jump, press it long, and the number will jump fast). After the time is appropriate, press “▶▶”; (for example, we need to set the time at 30 minutes)

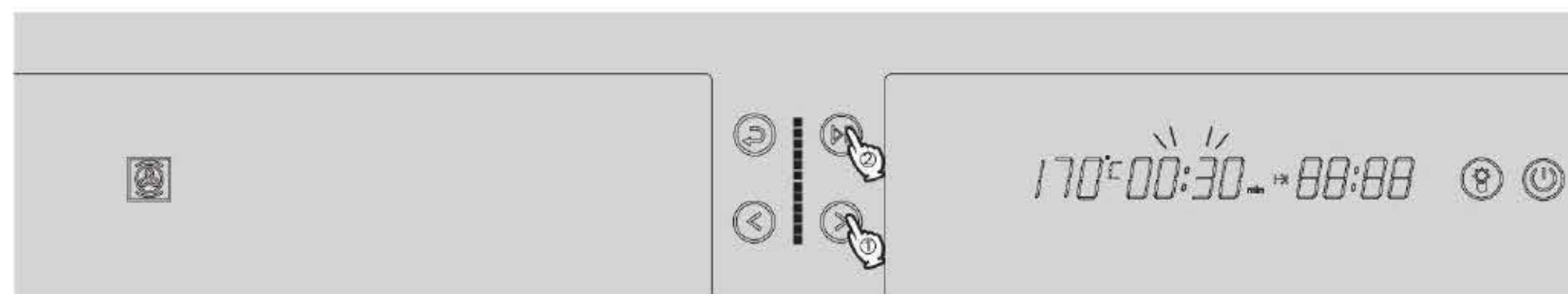

- After cooking time setting is completed, the appointment time lights (default display is 00:00). If there is need to make an appointment, then enter into appointment time setting mode. Press direction key “<” or “>” to set the time. Press it long, and the number will jump fast. When the time is appropriate, press “▶▶” to confirm. Then enter appointment time state and the time is started time. If there is no need to make an appointment, then press “▶▶” twice to enter into the cooking state directly after the cooking time is set. The direction key is invalid when the oven is working;

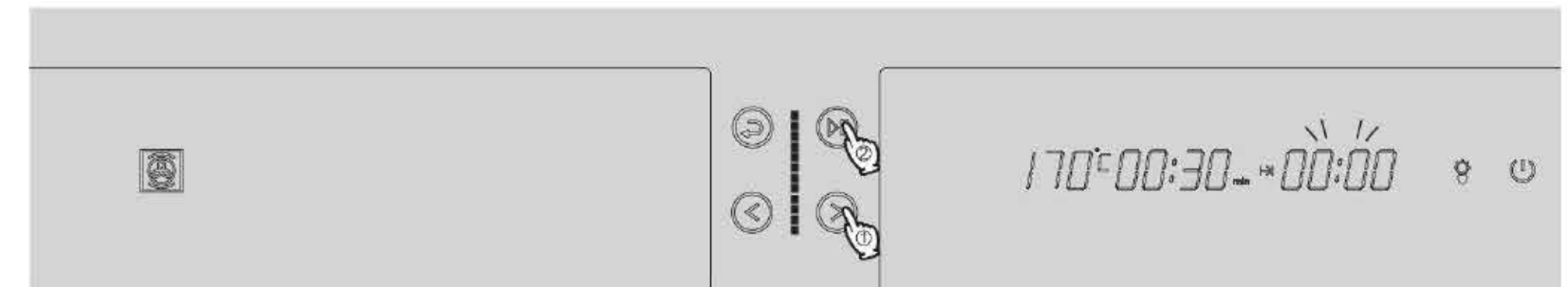

- * No appointment state: the light-emitting bar displays red and the working time is counted down. When it reaches the set working temperature, the light-emitting bar displays orange, and there will be a prompt tone (0.5 second);

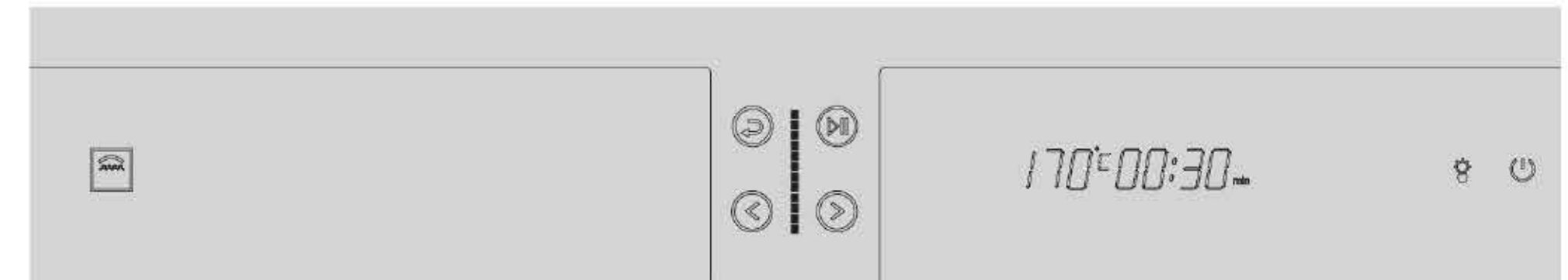

- * Appointment time state: the light-emitting bar displays no color, and the appointment time is counted down. The direction key is invalid when the oven is working. When it reaches the appointment time, there is prompt tone (0.5 second). Then enter into working state (the same as no appointment state);

- * For example: we need to set the appointment time for 30 minutes.

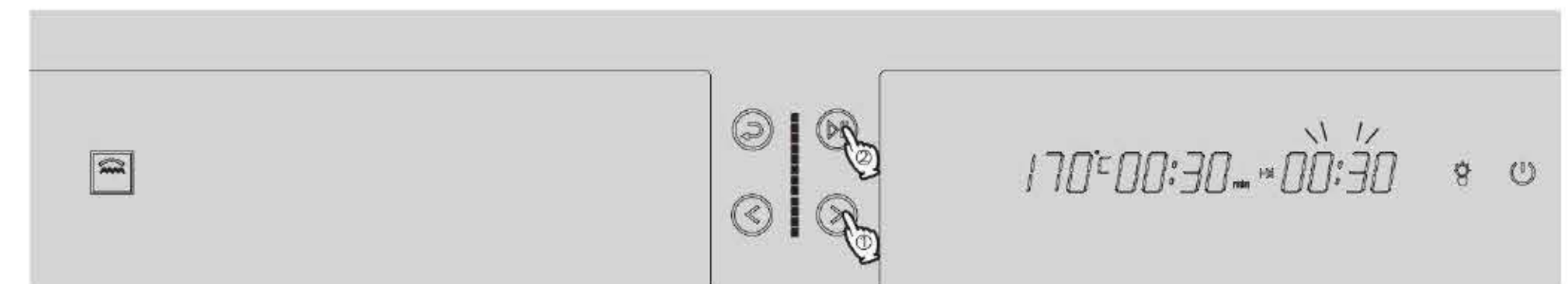

- The end of baking:

- * When it reaches the cooking time, there is prompt tone (5 seconds of multiple short sounds), and the light-emitting bar does not display color;

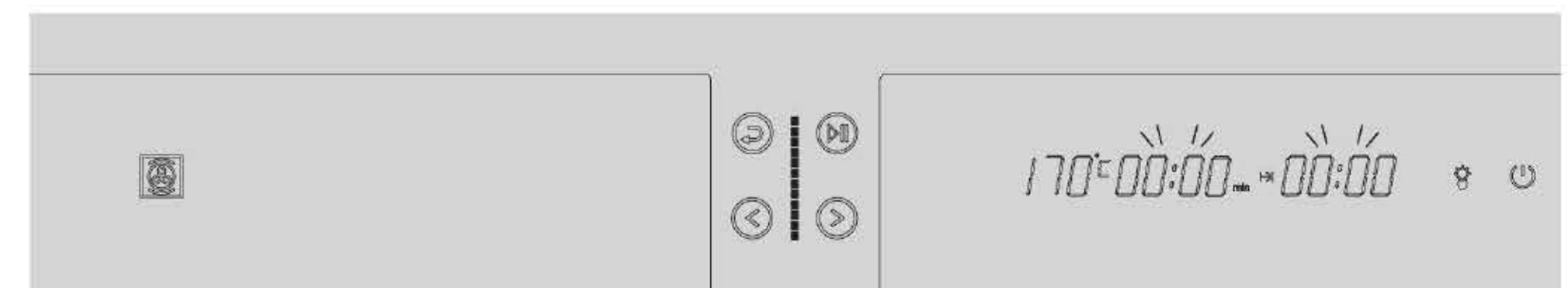

- If you want to suspend the cooking, press “▶▶” in the central area. If you want it to start working again, press “▶▶” to make it continue to work.

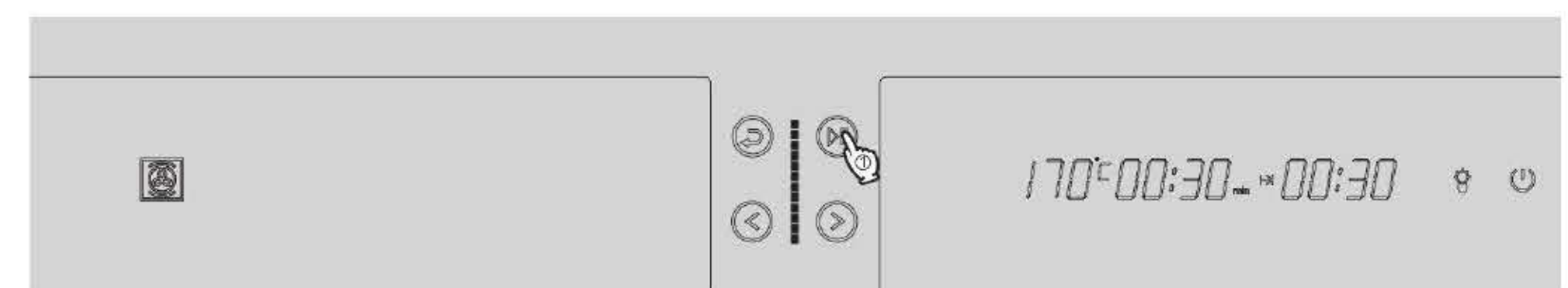

3) Return function:

When all parameters are set and it starts to work officially, press return key “↵” in the central area to modify the parameters. After pressing return key “↵”, the first step in the default will be going back to the left mode area for modification. At this time, the cursor of the setting mode begins to be highlight and flashing. Then, press direction key “<” or “>” key to select. After that, press the confirm key “▶” in the central area and it will automatically jump to modify temperature, time and appointment time on the right. At this time, all steps of modification, selection and confirmation are the same as those said above.

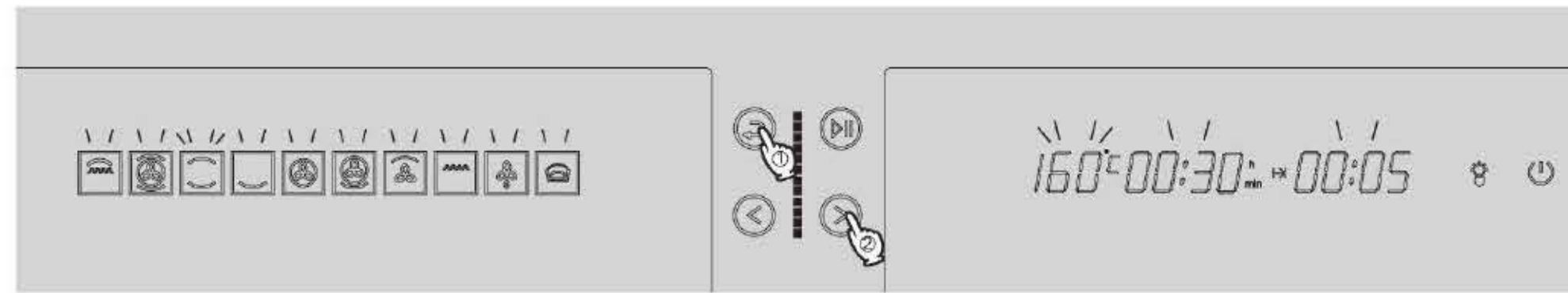

4) Lamp function:

During the cooking process, touch “💡” in the right area, the cooking lamp will light. Press it again, and it will go out. In the parameter setting, press any key, and all lamps are lit.

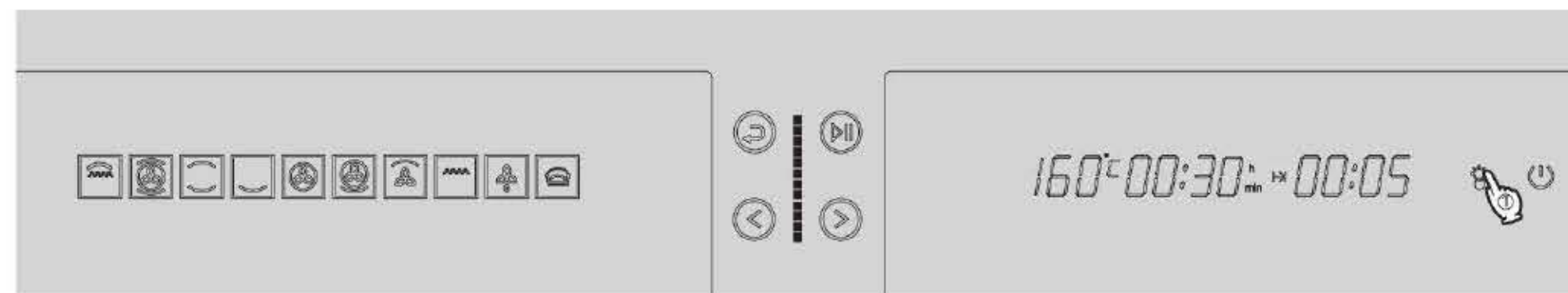

5) Conversion of degree Fahrenheit to degree Celsius:

Press “💡” for long time to switch the temperature unit. This setting will be the default in the next working.

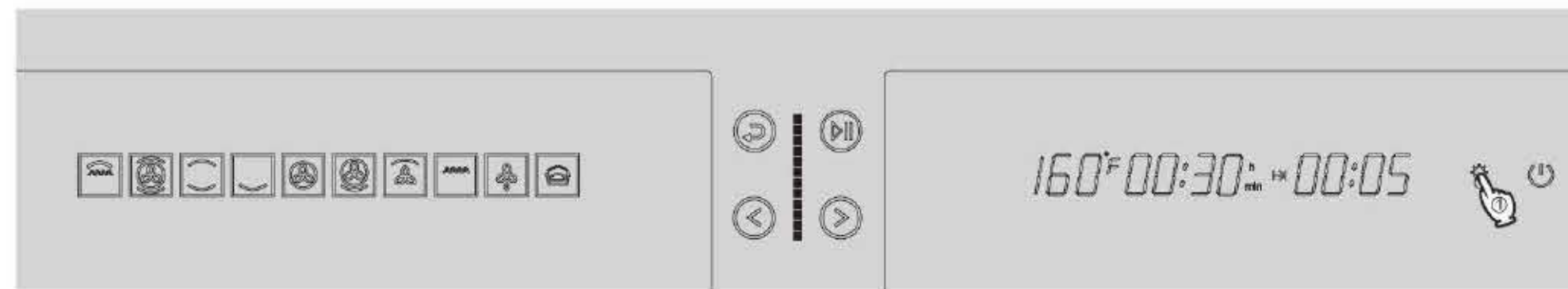

6) Child-Lock function

Press “▶” for 3 seconds to start the Child-Lock function; at this time, all keys are invalid, and the Child-Lock function will not be closed until “▶” key is pressed for 3 seconds again.

■ Function set up - KSG7003A

There are ten heating modes for selection. Every heating mode has its correspondingly default temperature.

1) Touch the “○” key to turn the oven on, and the display will be as following. If there is no any key touched, the screen will go out after two minutes.

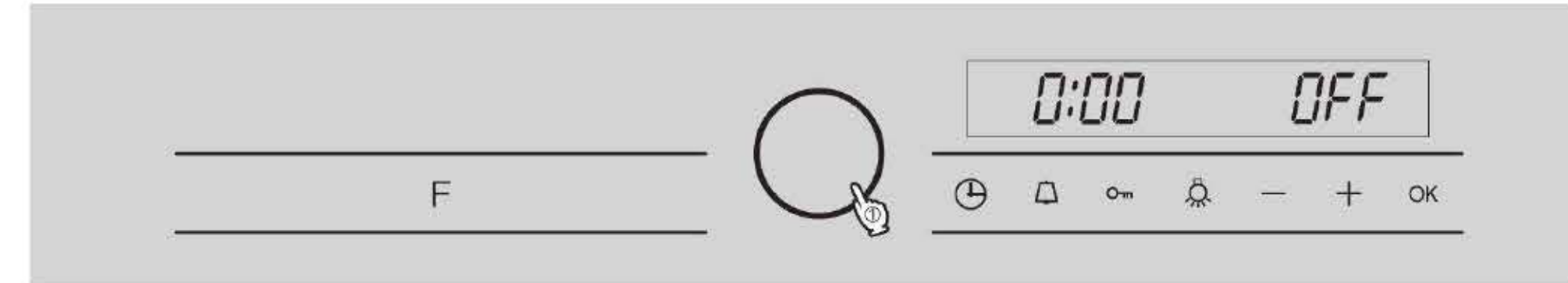

2) Touch the “F” key, and the display will be as following.

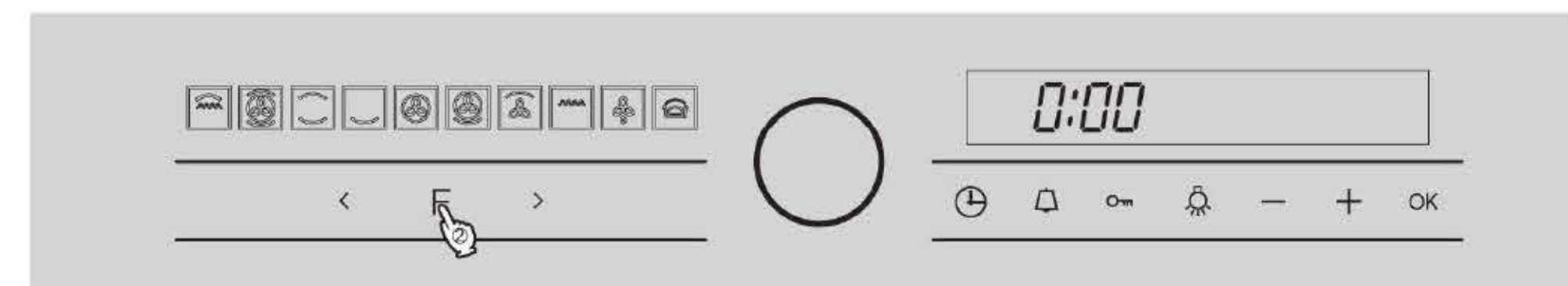

3) Then touch the “<” or “>” near the “F” to select the required function whose icon will flash accordingly, and the display will be as following.

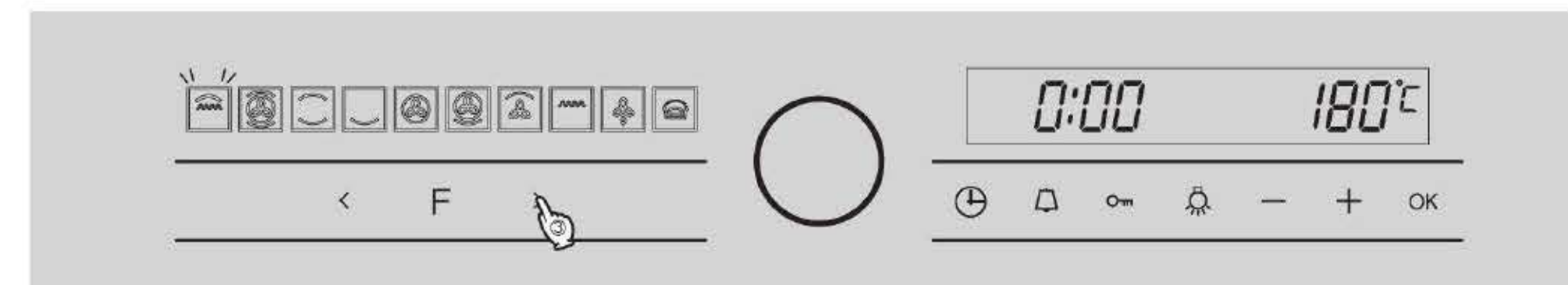

4) Slightly touch the “OK” to confirm your request, and the display will be as following.

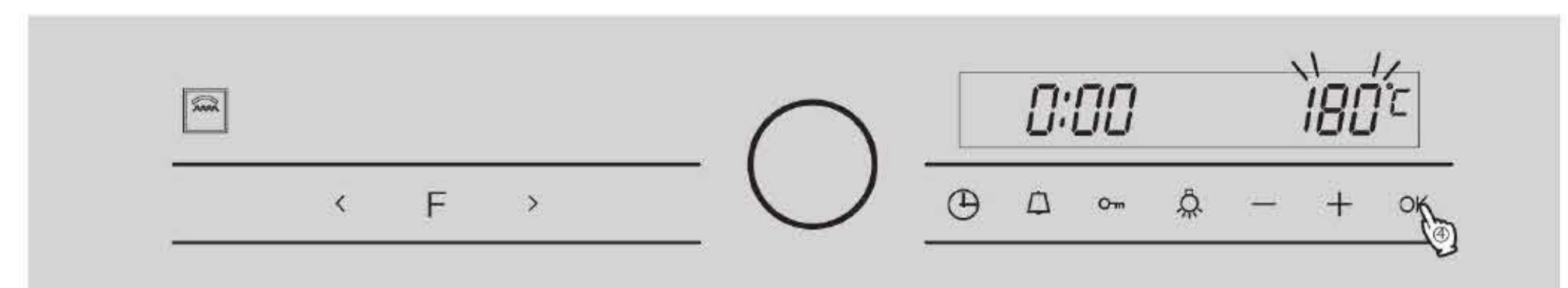

If you want to change your setup, please touch the “F” twice, then repeat step 3)~4).

Temperature set up

Set the required cooking temperature after cooking function is set. Because every cooking mode has its recommended heating temperature.

Please set the function which you want. Refer to "Function set up".

- 1) The temperature icon will flash as soon as the function has been set, please touch the "—" or "+" to select the required temperature (touch it long and the number will jump fast 5°C one jump). Refer to the following fig.

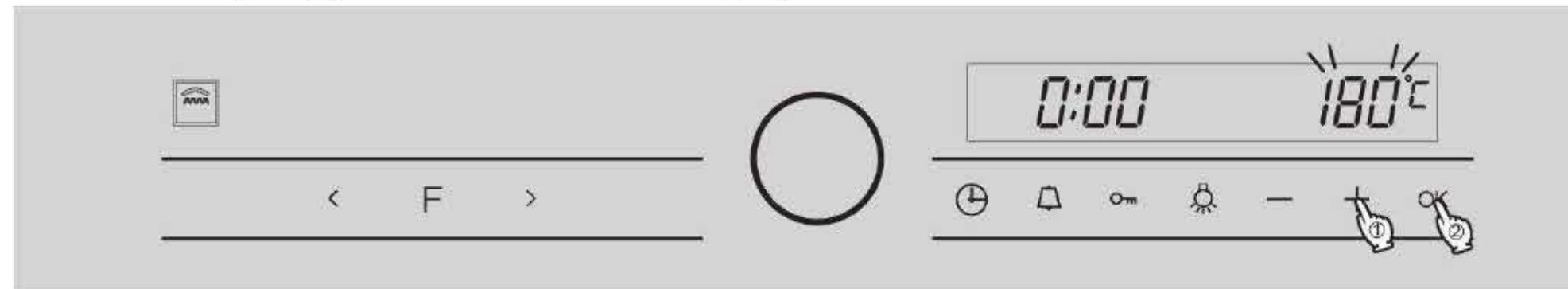

- 2) Please confirm the required temperature through touching the "OK" key.
- 3) The oven starts heating up as soon as the cooking programmes are set.



1. If you want to change the temperature you set, please touch the "—" or "+" to repeat step 3).
2. Each touch of the "—" or "+" key alters the temperature in one Fahrenheit or Celsius unit increments. Constantly touch one of these keys, it will speed up the process.

Temperature display





The oven starts heating up as soon as the cooking programmes are set, and the display will show the oven inner cavity temperature. There is a temperature process bar beside the temperature icon, which reflects the difference between the actual temperature of cavity and the temperature you set.

Simultaneously touch "—" and "+", which can change the temperature unit between Fahrenheit and Celsius.

During the heating, touch "—" or "+" can view the set temperature.



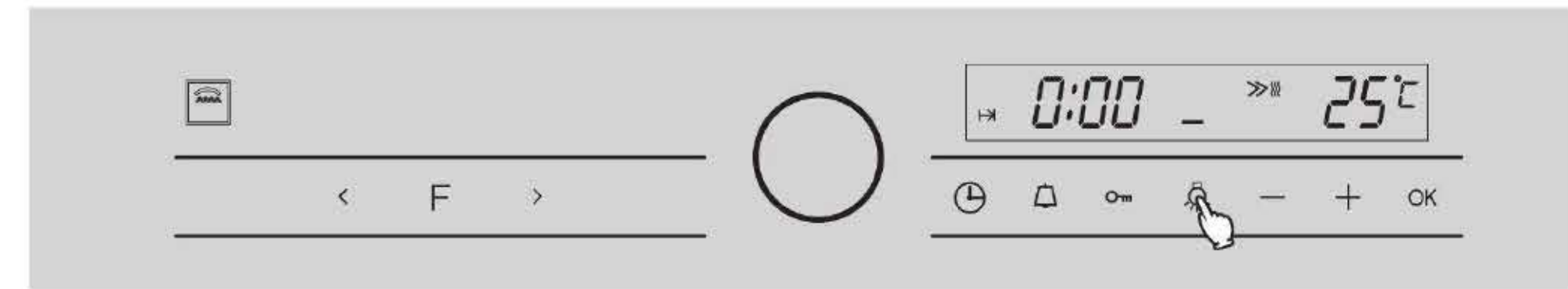

When the set temperature is reached, a sound like "D" is heard.

Oven interior light

"" can switching on the oven light independently. Slightly touch the Key "", the light in the oven will be switched on. Touch it again, the light will be switched off. This can be useful when cleaning the oven.



Child Lock

Set the child lock: touch the Key "", and the icon "" appears, then any key will be invalid besides the power key. Release the child lock: touch the Key "" for three seconds, the icon "" will disappear.

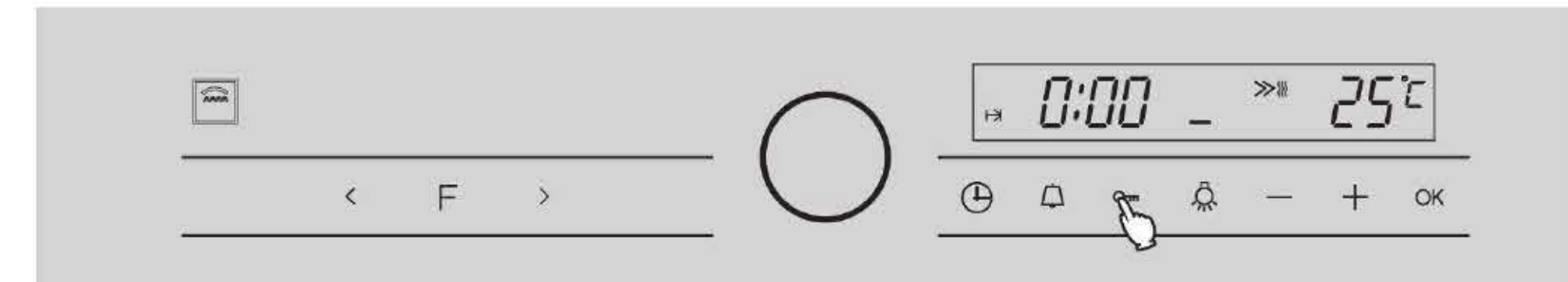













Clock/Timer

The clock/timer can:

- show the time of day,
- be used as a minute minder,
- switch the oven off, or on and off automatically.

Controls

The clock/timer is operated by using the "", "", "", "", and "OK" keys together with the display.

Keys	Function
	-To select the "Cooking duration" function -To select the "Time of day" function -To select the starting time of the cooking programme
	-To select the "Minute minder" function
OK	- Confirmation
	-To decrease the time or temperature
	-To increase the time
Display icon	Meaning
	Alarm has been set .
	Cooking duration has been set
	The oven is working
	The started time has been set

Operation

When you select a function, and the icon displaying hour will flash to remind the user to input time. You can only enter a time/duration while the icon is flashing (6 seconds approx.). If you fail to make an entry during these 6 seconds you will have to call up the icon in the display again.

Each touch of the “-” or “+” key alters the time in one minute or one hour increments. Constantly touch one of these keys, it will speed up the process.

Touching the “OK” key to save your setting.

When the display screen is displaying for more than two minutes without cooking, the display will be off automatically, turn into energy-saving mode.

To set the time of date for the first time



After connecting the appliance to the mains electricity supply, the machine will utter a sound like “D”. The display window flashes “0:00” for six times, reminding the user to input the present time. Please enter the time by touching “-” or “+” key immediately, then touch “OK” to confirm your setting.

e.g. eight o'clock, then the display will be the following:

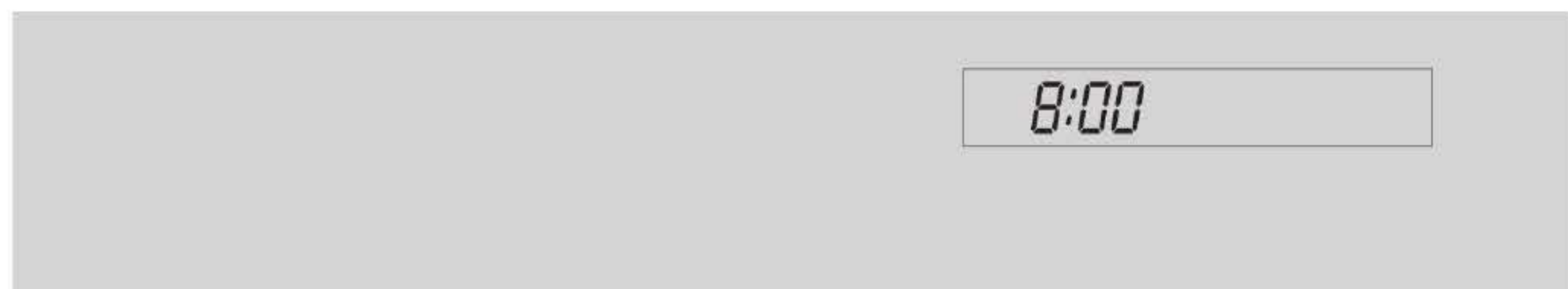

If the user does not input the time in six seconds, the window will display 0:00 and the clock begins automatically timing.

Changing the time of date

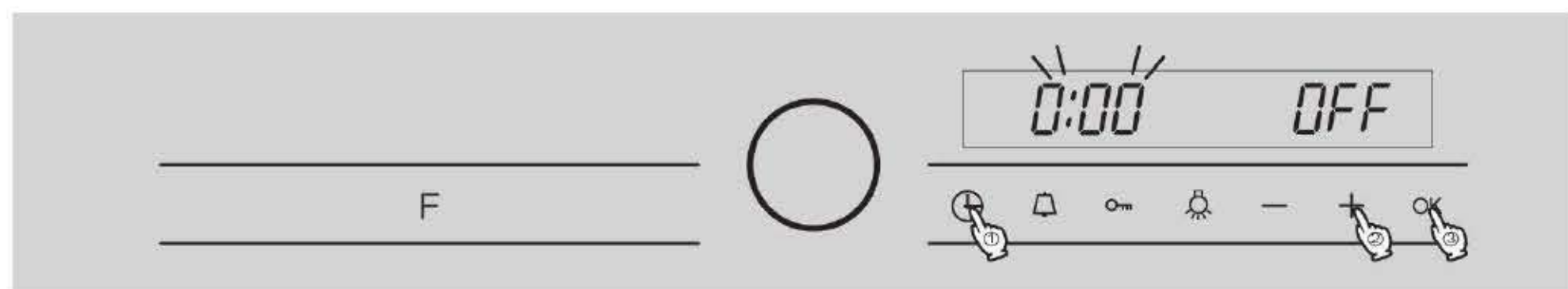

1. Touch the Key “min”, and the icon displaying hour will flash to remind the user to input time.
2. Touch the Keys “-” or “+” to set the hour. Touch the Key “min”, then the minute will flash. If you don't set the hour, Please wait for 6 seconds till the digital screen automatically changes to the minute setting. Touch the Keys “-” or “+” to set the minute.

3. Touch the Key “OK” or “min” to confirm the time, or wait for 6 seconds till the time is automatically confirmed, and then the icon will stop flashing.

The clock has a 24 hours display.

The timer counts down in minutes.

If there has been a power cut off, the time of day has to be re-entered.



The time of day can not be adjusted during cooking or in the preset roast state.

Using the minute minder

The minute minder can be used to time any activity in the kitchen, e.g. boiling eggs.

You can set the minute minder at the same time as another timed programme, e.g. as a reminder to baste your roast or add seasoning etc.

A minute minder time can be entered between 1 minute and 23 hours 59 minutes.

To set the minute minder

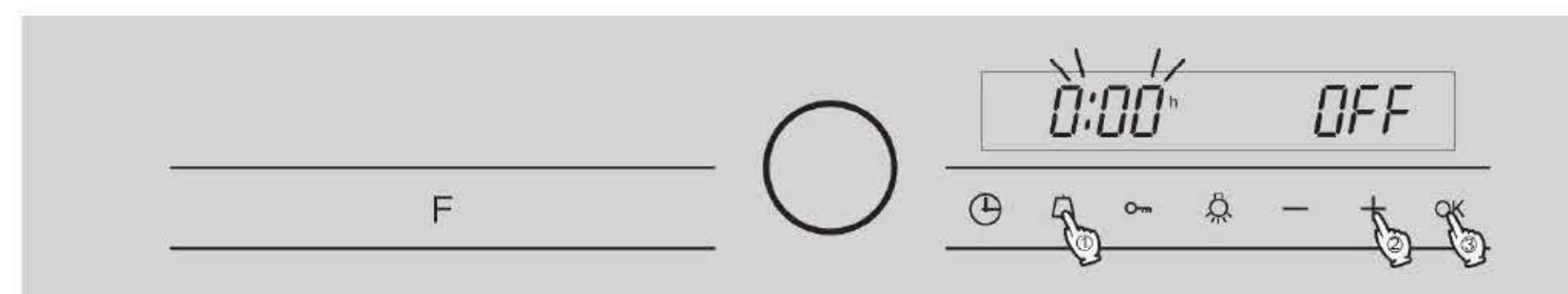

- Touch the Key “min”, the “hour” icon displaying and flash. After setting the hour, touch the “min” Key then minute will flash. Enter the time required for the minute minder whilst the bell symbol “min” is flashing. The method is the same as setting the time of date such as the above. After the setting, the display will revert to showing current clock. The “min” icon continues to be visible as a reminder that the minute minder is working.
- When current clock is on display, the user can touch the Key “min” to view the remaining time through the display. Six seconds later the display will revert to display current clock. The minute minder time set can be changed as long as the “min” icon is flashing.
- Cancel the minute minder: Whilst “min” icon is flashing in the display use the “-” or “+” keys to set the minute minder time to “0:00”. The minute minder time is deleted and the time of day reappears in the display.
- At the end of the time set for the minute minder – the oven will sound for approx. 10 times. Then display will show current clock.



The minute minder can be used independently, that is, its work will not influence other functions. The alarm will not stop work when the oven is turned off. When oven is turned off and the it reaches the alarm time, there is prompt tone and the screen will show current time. After two minutes, the screen will go out.

■ Programming cooking durations

Oven will start cooking as long as the heating mode and temperature are set. the cooking duration is a maximum of 10 hours.

On oven with a clock/timer you can also programme cooking durations so that the oven switches off, or on and off automatically.

When baking, the oven should not be set to work for a long time. Otherwise batter or dough will dry out, and raising agents will lose their effectiveness.

Timed roast:

Place the food in the oven.

Set the required function and set the temperature.

- Touch the Key “⌚”, the icon displaying hour and the icons “⌚” will flash to remind the user to entry cooking duration. The user can touch the Keys “-” and “+” to adjust the hour. Six seconds later the display will automatically switched to the “minute” setting or switched to the “ minute ” setting by touched the key “⌚” and the icons “⌚” will flash. Please adjust the min by touch “-” or “+”.

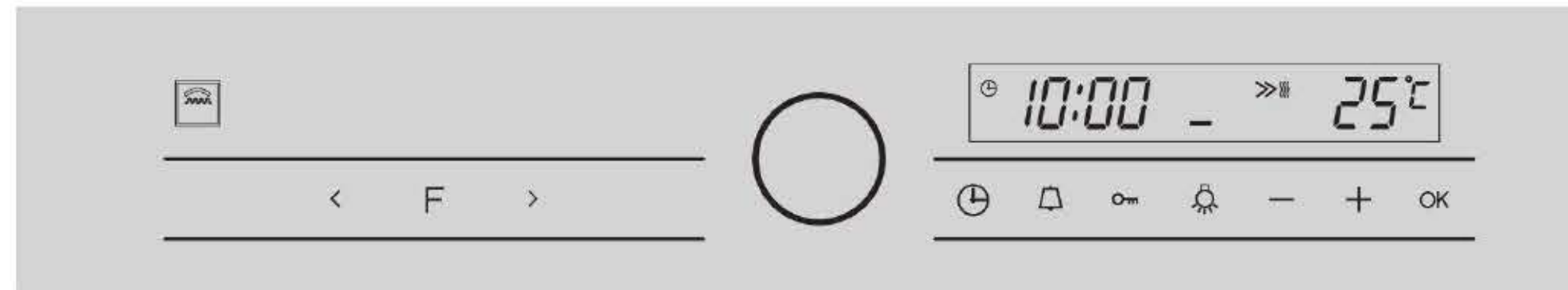

- Touch the “OK”, then the oven will start a timed roasting, the display will show current clock as well as the icons “⌚” and “>>”.
- After the setting
Touch the icon “⌚”, and the remaining time will appear in the display. And 6 seconds later, it will come back to the former state. You can adjust the duration when flashing. and the operation will be as the same as setting.
If you want to stop timed roast, please touch “F” or “○”.
- When the cooking ends, the heating is stopped too. The appliance will beep 10 times in order to notify the user. Then it will show current clock.



The longest cooking duration is ten hours. When the time duration for roasting is between 0 and 6, the icon “⌚” will appear. When it starts a timed roasting, touch the key “⌚” one time to modify cooking duration.

Preset roast:

Place the food in the oven.

Select the required function and set the temperature.

- Touch the Key “⌚” once to input time duration for roasting. It is the same as setting timed roasting.
- Touch the key “⌚” again, the preset started time and the icon “⌚” will flash. Touch the key “+” to set the started time. The key “-” can't be touched at this moment (the started time must be more than the clock time). Then touch the key “OK” to confirm.
Before reaching the started time, the screen shows the clock time and when reaching the started time, the screen shows the duration time and starts count down. If you don't touch the key “OK” to confirm, the icon “⌚” will flash to remind and temperature will be shown.

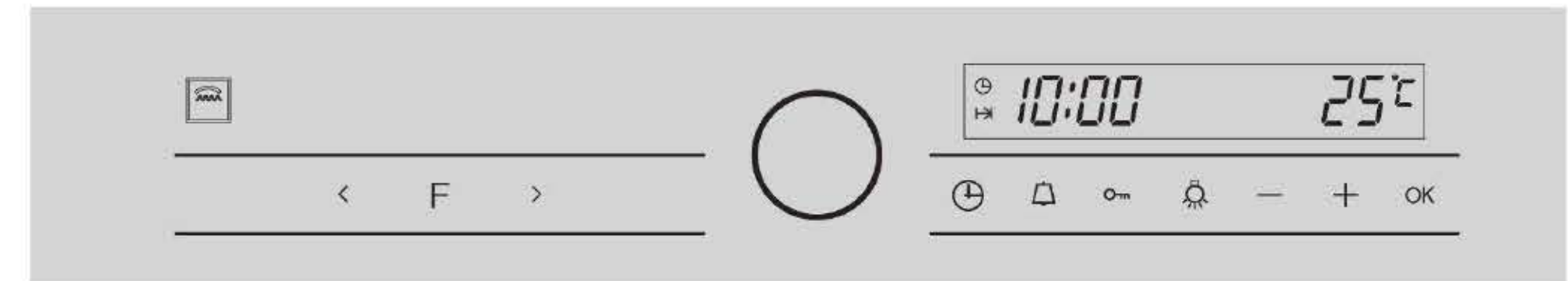

- After the setting
Touch “⌚” twice, it will show the ending time. and six seconds later, it will come back to the former state.
You can adjust the time when flashing, and the operation will be the same as setting.
Touch “⌚” once, it will show the heating duration that you set. and six seconds later, it will come back to the former state.
You can adjust the time when flashing, and the operation will be as the same as setting.
If you want to stop Preset roast, please touch “F” or “○”.
- When the roasting is finished, the appliance will beep 10 times in order to notify the user. Then it will display current clock.









The duration from time-setting point to finish time point is at most 23 hours and 59 minutes.











Oven Functions

Oven functions

Your oven has ten function modes to choose.

Clockwise sequence	Icon	Desirable cooking function	Remarks
1		Top heating, applicable for making golden surface of the foods that are cooked by other appliances. For example, plate-filled broad noodles, potatoes, cheese and varied sausage foods.	The cooking result is similar to the heating elements on the top will be working. Set directly to the highest temperature for food needing high surface temperature. Put the grill on "3" and "4". Put the food in the middle of the grills.
2		Quickly roast foods on several grills at the same time. Applicable for large-volume meat. Remain the original flavor. Like a rotisserie, applicable for large-volume food.	The cooking result is similar to the back heating elements start working with the upper and lower heating pipes and the fans; two grill racks at most can be used at the same time.
3		Preheat the oven to required temperature, applicable for cooking large-volume food (e.g. cakes). Place the food in the middle of the oven.	The cooking result is similar to the upper and lower elements are working simultaneously. Use one grill rack, otherwise, the heat may not be evenly distributed.
4		Applicable for crispy cakes and pizzas, as well as preserving heat.	The cooking result is similar to the lower heating element working. Set temperature at 40°C to preserve heat for cooked foods, ferment dough and brew wines.
5		Applicable for various foods and frozen foods in particular. Remain the original flavor. Long cooking time but more delicious taste.	The cooking result is similar to the back heating element and fan working together. When the temperature is set at 40°C it can be used to defrost meat even in winter.
6		Applicable for cooking foods like pizza, cheese biscuit, and fruit pies that should not be overcooked.	The cooking result is similar to the back heating element and lower heating element will be turned on and off together.
7		Applicable for making crispy foods.	The cooking result is similar to the upper element is working with fan.
8		Applicable for small food like steak to save energy.	The cooking result is similar to the upper also middle element.
9		Defrost	
10		fermentation	Put the kneaded clough into a container and cover with a plastic wrap. Then put the container on the baking tray which is placed in the second layer. Add a bowl of water of 200ml and select the mode " ", It will work after setting time.

Cooking Suggestions

Number	Icon	Food	Weight(Kg.)	Suggested temperature/°C	Cooking time (minutes)	Location of grills
1		Cookies	0.25	140-160	20-30	2
		Chiffon cake	0.5	150-160	30-50	2
		Bread	0.5	160-220	15-40	2 or 3
		Tart&Pie	0.5	170-190	20-60	2
		Puff	0.5	190-210	25-45	3
2		Cupcake	0.5	160-180	20-35	2
		Toast	0.5-1	150-170	35-55	2
		Sponge cake	0.5	150-160	30-50	2
		Lamb baby back ribs	1-1.5	190-210	20-30	3
		Muffin	0.5	180-190	15-25	3
3		Pizza	0.5	190-210	10-30	2
		Egg tart	0.5	180-200	15-30	2
4		Sliced meat	0.5	180-200	10-25	3
		Vegetable skewer	0.5	160-180	15-25	3
		Kebab(a little)	0.5	190-210	10-25	3
5		Chicken wing	0.5	160-180	15-30	2
		Drumstick	0.5	160-180	20-30	3
		Fish	0.5	180-200	20-30	2
6		Kebab	0.5	190-210	10-25	3
		Sausage	0.5	150-170	15-25	3
7		Bread fermentation	0.5-1	35-45	40minutes-4hours	2
8		Beef jerky	0.5	70-100	90-150	2 or 3
		Dried shrimps	0.5	70-100	90-150	2 or 3
		Preserved fruit	0.5	70-100	90-150	2 or 3
9		Applicable for coloring, reheating, decoct for toast, pizza and pancake.				
10		Meat		35-60	20-40	2
		Fishsh		35-50	20-40	2

Cleaning and Care



Do not use a steam cleaner to clean the appliance. The steam could reach electrical components and cause a short circuit.

■ Appliance front and control panel

Clean the

- controls,
- door handle,
- trim inside the door,
- seal between the appliance door and the cooking compartment regularly, preferably after each use.

This will help to prevent grease and other deposits adhering to the surfaces and becoming difficult to remove and also in some cases, causing discolouration.

Grease deposits can also cause the seal to become brittle and crack.

1. All surfaces and controls should be cleaned using with warm water and a little washing up liquid applied with a soft sponge or cloth.
2. Wipe the surfaces dry using a soft cloth.

Do not use scouring agents, hard sponges, brushes or sharp metal tools to clean glass as these can scratch the surface.

To prevent the risk of scratches and damage to the surface structure of glass, stainless steel and aluminium fronted appliances, pay particular attention to the following cleaning instructions.

■ Glass fronted appliances

The appliance front and controls are susceptible to scratches and abrasion.

Avoid:

- abrasive cleaning agents, e.g. powder cleaners and cream cleaners;
- abrasive sponges, e.g. pot scourers or sponges which have been previously used with abrasive cleaning agents;
- sharp metal tools;
- oven sprays.

■ Stainless steel fronted appliances

The appliance front and controls are susceptible to scratches and abrasion.

Stainless steel surfaces can be cleaned using a cloth or with a proprietary non-abrasive cleaning agent designed specifically for use on stainless steel. N.B. Do not use stainless steel cleaning agents on the controls.

Avoid:

- cleaning agents containing soda, acids or chlorides;
- abrasive cleaning agents, e.g. powder cleaners and cream cleaners;
- abrasive sponges, e.g. pot scourers or sponges which have been previously used with abrasive cleaning agents.

■ Accessories

Always remove all accessories, trays and racks which are not being used when using the oven to get the best results and to keep cleaning of the trays to a minimum.

■ Normal soiling

Clean as soon as possible after each use with a dishcloth, soft sponge (such as the Vileda sponge supplied with ovens in the UK) or a soft nylon brush, and a solution of hot water and a little washing-up liquid. The longer soiling is left the harder it may become to remove.

■ Stubborn soiling

Stubborn soiling e.g. from roasting may need to be soaked first with a damp sponge to loosen it and if necessary a non-abrasive stainless steel spiral pad or a scraper suitable for glass surfaces can be used to remove it.

After cleaning rinse thoroughly with clean water. The water must run off the surface easily. Any residual cleaning agents will hinder this effect.



- 1) Soiling such as spilt juices and cake mixtures are best removed whilst the oven or tray is still warm. Exercise caution, make sure the oven is not hot - danger of burning! Spilt fruit juices may cause lasting discolouration of the surfaces and roasting can cause matt areas to appear. Clean these following the instructions given above and do not try and use force to remove them! This discolouration is permanent but will not affect the efficiency of the enamel.
- 2) When baking items with a high salt content (e.g. continental pretzels) place them on baking parchment in the baking tray or grill pan. Sodium deposits can cause lasting discolouration to porcelain enamel surfaces

■ Oven interior

Allow the oven to cool down before cleaning.

Danger of burning!

The oven interior (including the left / right support) and the inside of the door should be cleaned after each use. If this is not done subsequently soiling from baking and roasting will become worse and make cleaning harder. In extreme cases soiling will be impossible to remove or even cause damage to the surface material.

Do not use harsh abrasive cleaner or sharp metal scrapers to clean the oven doorglass/the glass of hinged lids of the hobs (as appropriate)/the ceramic surface, since they can scratch the surface, which may result shattering of the glass.

There is a rubber sealing-ring around the door of the oven, which should be checked frequently and cleaned when necessary, however, abrasive detergent should not be used.

If it is damaged, please contact local after-sales service center.

The oven should not be used before the sealing ring is replaced.

To make cleaning easier you can

- remove the oven door,
- dismantle the oven door,

Instructions for doing so are given further in this chapter.

■ To remove the oven door



The oven door is heavy. It should be gripped firmly at the sides when being removed or refitted. The oven door is connected to the oven by hinges.

Before removing the door, the locking clamps on both hinges have to be released.

- Open the door fully.(fig.1)
- Release the locking clamps on the hinges turn them upwards as far as they will go until they are at an angle. (fig.2)
- Lift the door upwards as far as it will go. Hold the door securely at both sides and lift upwards the hinges.(fig. 3)



- 1) To avoid the risk of the accident, injury, please DO NOT try to take the door out when it is in the horizontal position
- 2) To avoid the risk of accident, please DO NOT lift the door up by the handle.
- 3) Make sure that you lift the door up equally on both sides.

■ Refit the door

- Hold the door securely at both sides and carefully fit it back onto the hinges. Make sure that there is no space between the door and hinges. (fig. 4)
- Open the door fully.
- Flip both locking clamps back up as far as they will go into a horizontal position. (fig. 5)



To avoid the risk of hinges losing, accident, damage, please make sure that the locking clamps lock tightly when the door is refitted after cleaning.

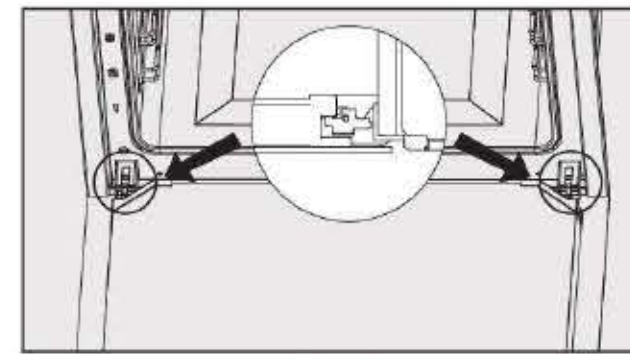

fig.1

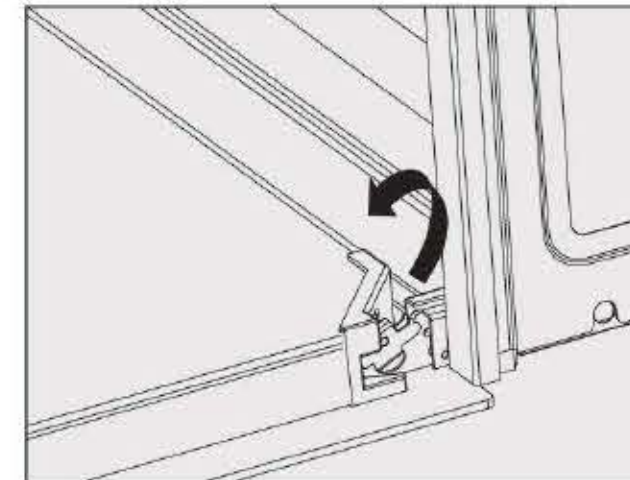

fig.2

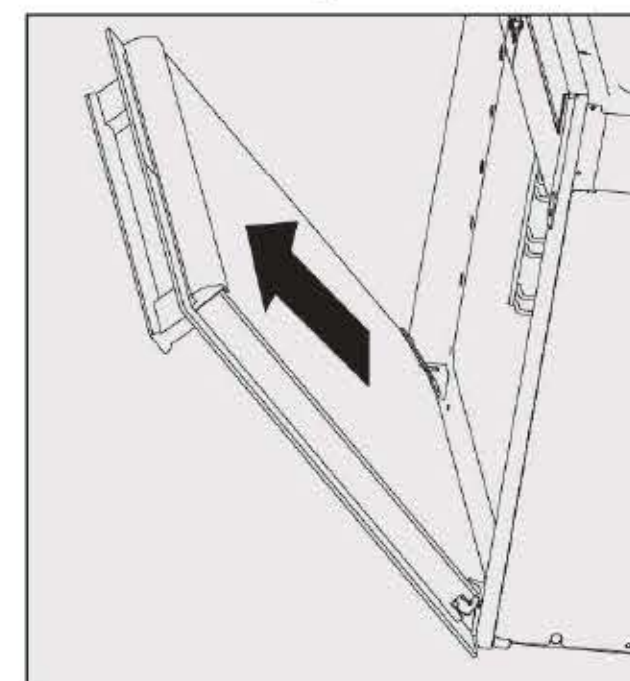

fig.3

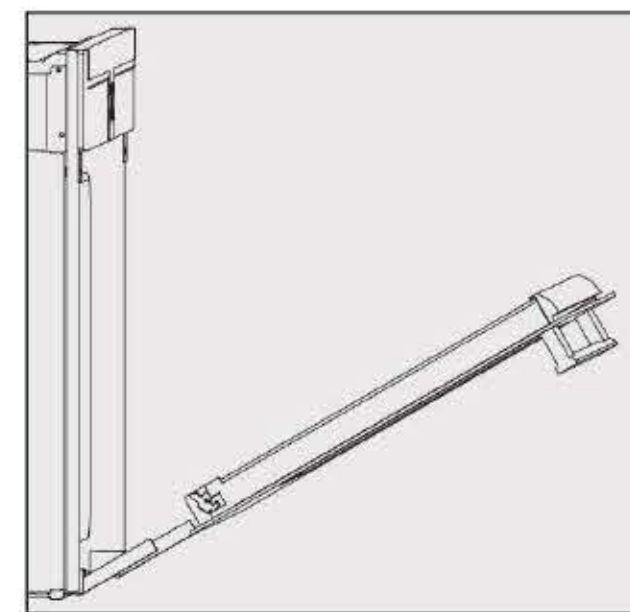

fig.4

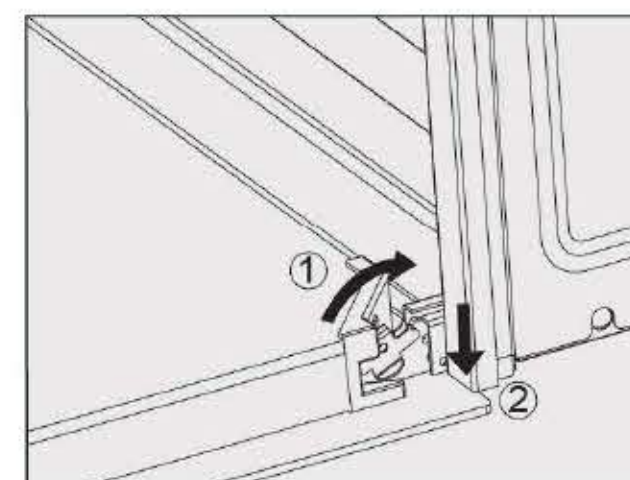

fig.5

Problem Solving Guide

In strict accordance with current national and local safety regulations, maintenance and repairs may only be carried out by a suitably qualified and competent person. Repairs by the other persons could be dangerous.

With the aid of the following guide, minor problems can be easily corrected. If this can not be solved, please switch off the power supply and contact our customer service center.

Problem	Possible cause and remedy
The oven does not heat up.	<ul style="list-style-type: none"> - Check that the function and the temperature have been set at the function and temperature required. - Check whether the mains fuse has tripped. If it has, contact a qualified electrician or the FOTILE Customer Service Centre.
A noise can be heard after a cooking process.	<p>This is not a fault .</p> <p>The cooling fan continues to run for a while after the oven has been switched off to prevent any humidity building up in the oven, on the control panel or on the oven housing unit. When the temperature has fallen sufficiently, the fan switches off automatically.</p> <p>The temperature will fall faster with the oven door open.</p>
Foods are not cooked properly after following the times given in the chart	<ul style="list-style-type: none"> - Check that the correct temperature has been set. - Check that rack/tray position is correct or the shelf is level.
Browning is uneven.	<p>There will always be a slight unevenness. If browning is very uneven, please check:</p> <ul style="list-style-type: none"> - whether the temperature was set too high, - whether the correct shelf level was used
<p>“⊖” is flashing</p> <p>“→” is flashing</p>	It may be the reason that you forgot touching “ok” key

In the event of any faults which you cannot remedy yourself, or if the appliance is under guarantee, please contact

- Your FOTILE Local Dealer

When contacting the Customer Service Centre, please quote the model and serial number of your appliance. These are shown on the data plate, visible at the top of the oven.

Installing the Oven

■ Electrical connection

The installer must check that

- 1.The voltage and cycles of the mains supply correspond to that indicated in the rating plate of the appliance.
- 2.The electrical installation can stand the maximum power indicated in the rating plate of the appliances.
- 3.The electrical connection has adequate earthing in accordance with regulations in force.

4. Turn off power when clean the oven, exchange bulb or in emergency.
5. Air Switch connecting 25A electric current.
6. After making the electrical connection, verify the correct working of all the electrical parts of the oven.
7. The manufacture is not liable for any direct or indirect damage caused by faulty installation operations are carried out by unqualified personnel or not complying with the local and general regulation in force.
8. The wiring diagram is as follows:

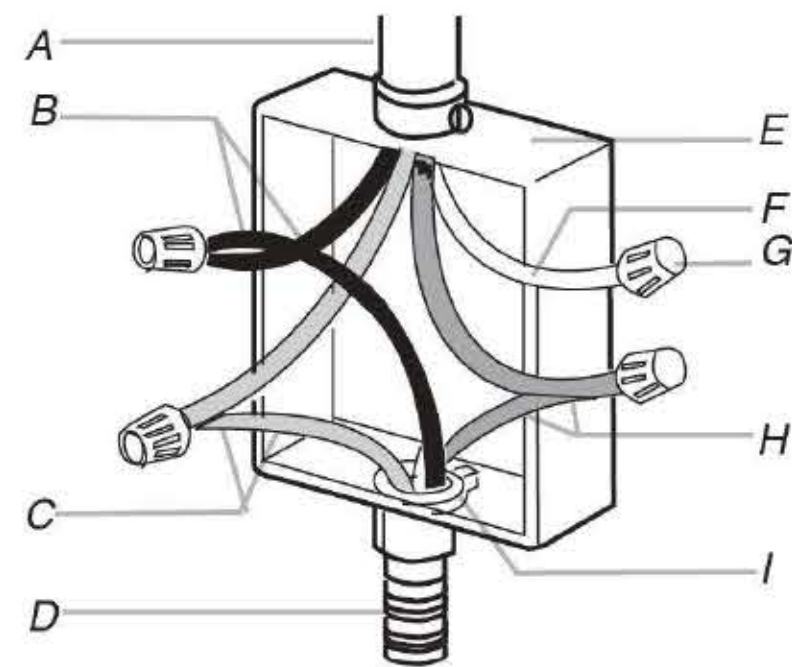

- | | |
|--------------------------------------|--|
| A. Cable from home power supply | E. Junction box |
| B. Black wires | F. White wires |
| C. Red wires | G. UL listed wire connectors |
| D. 3-wire flexible conduit from oven | H. Green (or bare) ground wires |
| | I. UL listed or CSA approved conduit connector |

- a. Connect the 2 black wires (B) together using a UL listed wire connector.
- b. Connect the 2 red wires (C) together using a UL listed wire connector.
- c. Connect the green (or bare) ground wire (H) from the oven cable to the green (or bare) ground wire (in the junction box) using a UL listed wire connector.
- d. Install junction box cover.

■ Installing the oven

The oven must be built in before it can be used. Otherwise it poses an electric shock hazard.



Do not fit insulation material inside housing unit. This would hinder the intake of air to the appliance.

Before installing the oven, please pull out the plug.

Flush installation

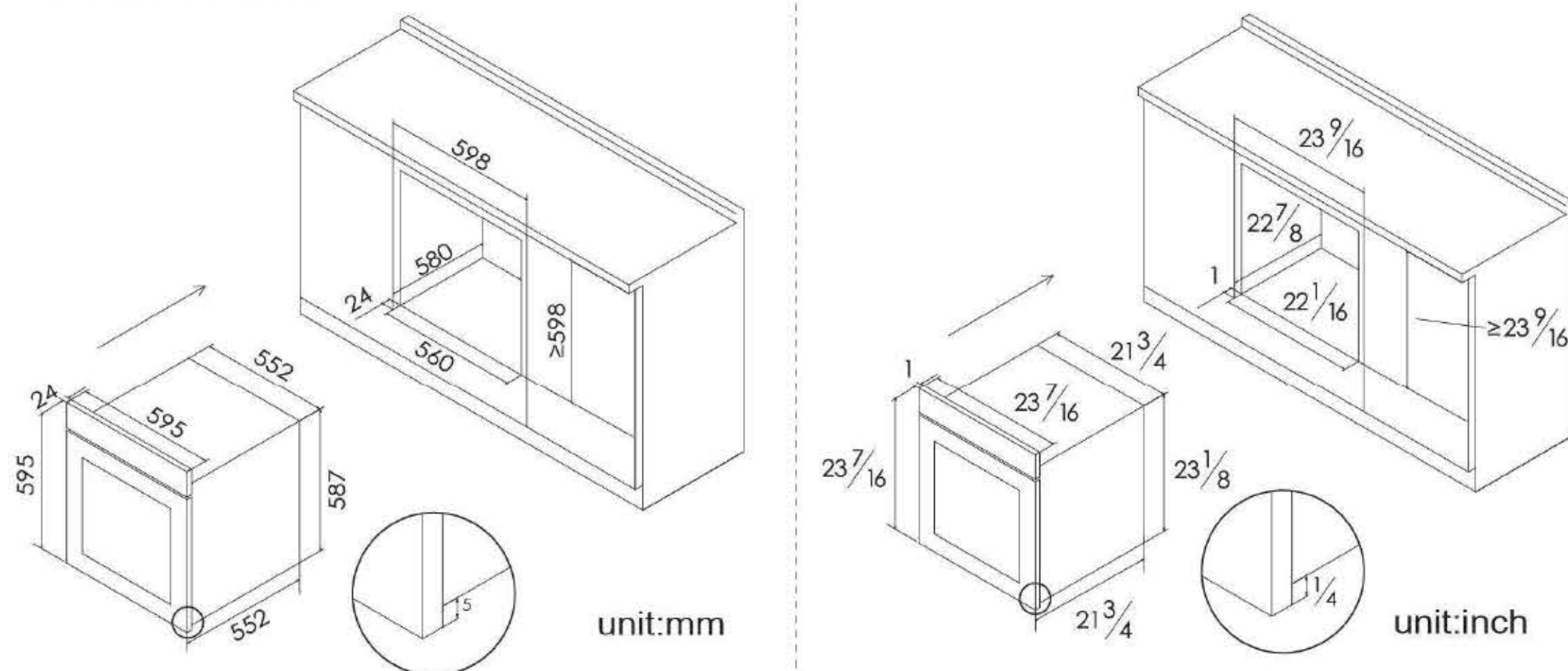

Standard installation

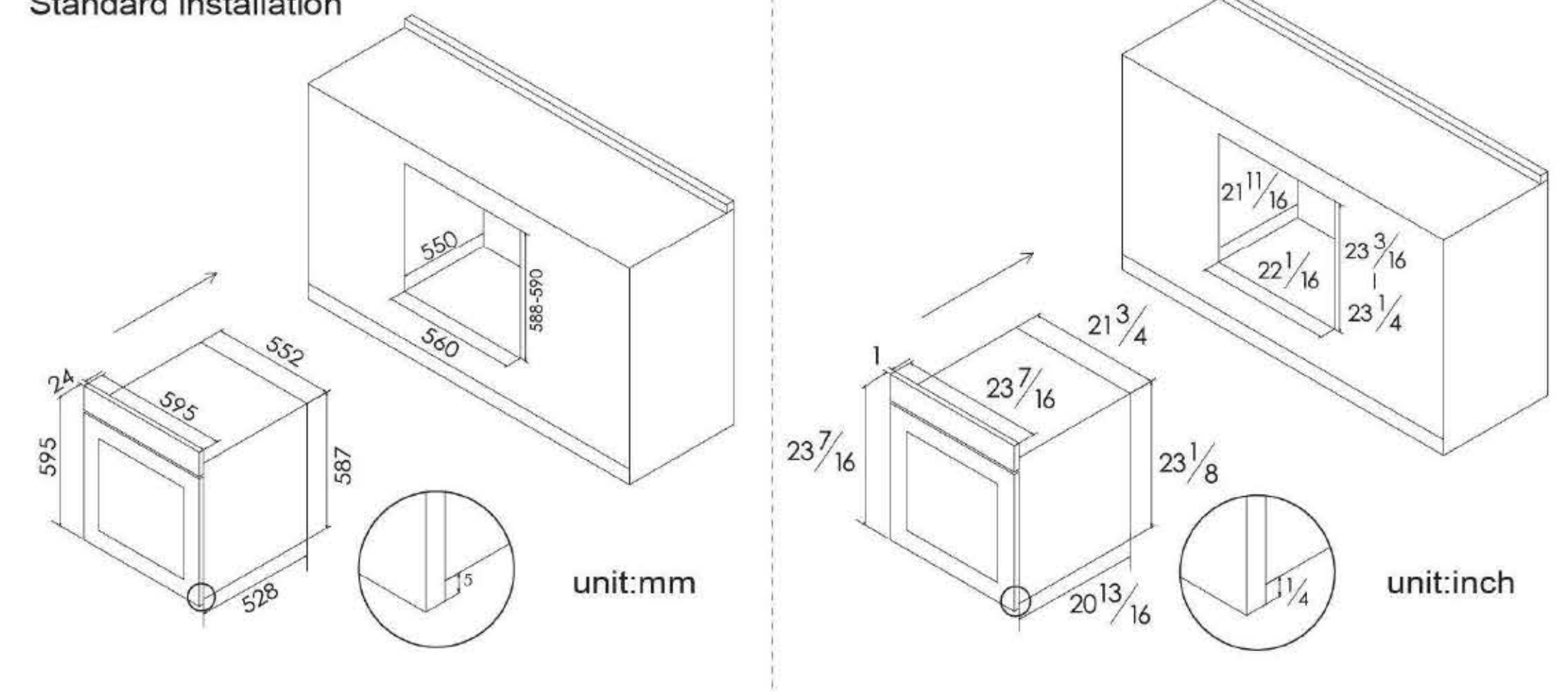

Open the oven door and using two screws secure it to the side walls of the housing unit through the holes in the oven trim.

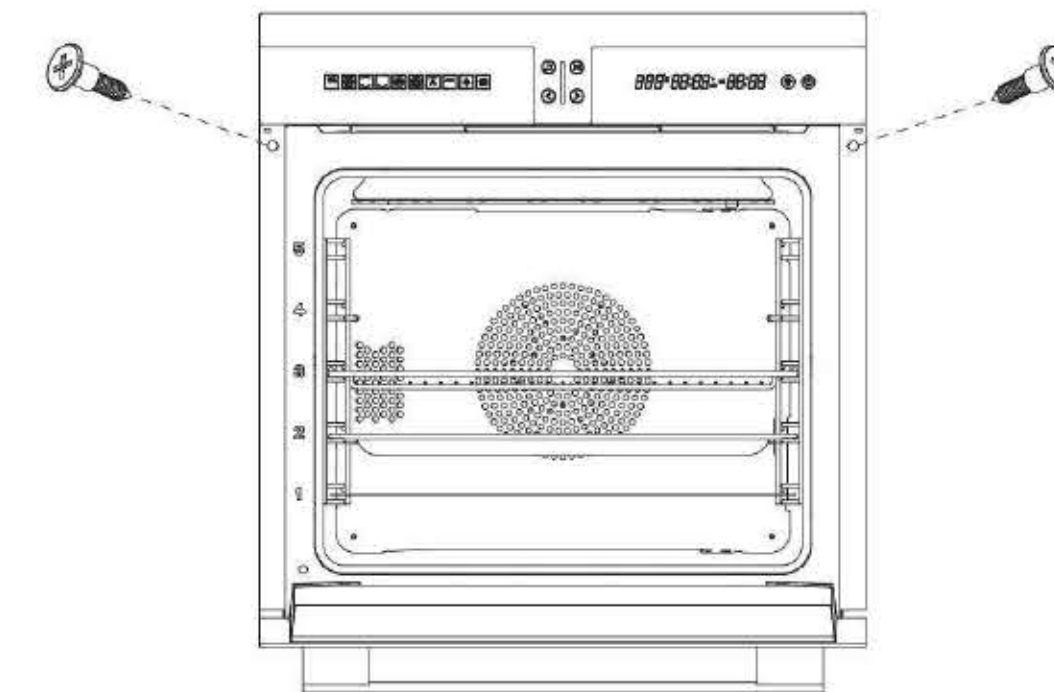

- 1) To protect the surface coating the rubber rings should be put when fasten the screws.
- 2) Install the oven firmly and upright on level places that are convenient for operation and maintenance.
- 3) The oven and power cord should not be installed on humid places or places easily affected by rain.
- 4) Lift the oven from the hand held hole or from the bottom during the transition and installation. Never draw the door or the handle to move the oven.
- 5) The oven can be built into a cupboard, whose base plate should undertake at least 60kg.
- 6) The materials of the cupboard should resist above 120°C temperature.
- 7) Leave at least 45mm-long space at the rear of the cupboard for the sake of ventilation.

FOTILE 方太

使用说明书

请妥善保管，以备参阅

使用产品前请仔细阅读
本说明书

电 烤 箱

KSS7002A
KSG7003A

目 录

警告和安全须知	2
关爱环境	4
应用指南	4
包装清单	4
部件名称	5
技术资料	5
特性	5
首次使用的清洁和加热	6
控制	6
功能设置 - KSS7002A	6
功能设置 - KSG7003A	10
温度设置	11
烤箱内灯	11
童锁	12
时钟/定时器	12
设置烹饪时长	14
烤箱功能	16
烤箱功能	16
烹饪建议	17
保养清洁	18
问题解决指南	20
安装烤箱	20

警告和安全须知

本电器符合当前的安全要求。然而，不恰当的使用会导致人身伤害和财产损失。为了避免事故风险和对本电器造成损坏，在首次使用之前，请仔细阅读该须知。该须知已包含了安装、安全、使用和维护方面的重要说明。请妥善保存该安全须知，并确保新用户熟悉此项内容。并且请确保将此须知随产品共同交付后期使用者。

正确应用

1. 本电器适用于家庭的食物烹饪，特别是烘焙、烘烤、烤肉、解冻和干燥水果。任何其它用途所产生的风险均应由拥有者承担，并且可能存在危险。针对由于不正确或不恰当的使用或操作而导致的损坏，制造商不承担任何责任。
2. 本烤箱不得由有生理、感知或心理能力方面存在缺陷或缺乏经验和知识的人员（包括儿童）进行操作，除非他们在操作时得到了负责他们的安全人员的监督或指导。
3. 警告-可触及零件在使用过程中可能会发热，为了避免烧伤儿童应当远离。

儿童安全

1. 应监督好儿童，确保其不会将本电器当玩具玩耍。
2. 对于年龄较大的儿童，他们只有在下列条件下才可以使用本烤箱：已向他们清楚明白地解释了本电器的操作，他们能够安全地使用本电器，并且他们已认识到不恰当使用的危险。
3. 在使用本电器的过程中，应非常谨慎地确保儿童不会接触到本电器。因为相比于成人，儿童的皮肤对高温则更为敏感。烤箱的外部部件（比如玻璃门）和通风孔在工作期间将会变得非常热。
4. 在使用过程中，烤箱会发热。应当注意避免接触烤箱内的加热元件。

技术安全

根据现行的国家和地方安全法规，本电器的安装、维护和修复只能由具备适当资格和能力的人员来进行。由不具备资格的人员进行修复和其它工作可能存在危险。对于未经授权的工作，制造商不承担任何责任。

1. 在安装之前，应检查电器是否存在可见的损坏迹象。在任何情况下均不得使用已受损的电器。受损的电器可能存在危险。
2. 只有本电器和有效的接地系统之间存在完整的连续性，本电器的电气安全才可以得到保证。最为重要的是存在这一基本安全要求，并且其得到了定期的测试。如有任何疑问，应请具备资格的电工对家居布线系统进行检查。针对由于不恰当的接地系统而导致的后果（比如电击），制造商不承担任何责任。
3. 在将本电器连接到主电源之前，请确保参数标牌上的额定值符合现场电源的电压和频率。如有任何疑问，请咨询具备资格的人员。
4. 不得通过一个多插座单元或一根延长线将本电器连接到主电源上。这些无法保证本电器的安全要求（比如过热危险）。
5. 由于安全原因，本电器只有在完成安装之后才可以进行使用。
6. 绝对不要打开本电器的外壳。篡改电气连接或组件及机械部件对于用户而言是高度危险的事情，可导致操作故障。
7. 当本电器仍在保修期时，只有经制造商授权的服务技术人员才可对其进行修复。否则，保修将无效。
8. 在安装、维护和修复工作进行期间，本电器必须关闭。
9. 故障组件必须由正版方太（FOTILE）原装备件进行更换。只有使用了方太（FOTILE）的替换部件，制造商才可以保证本电器的安全。
10. 如电源线受到损坏，其必须由方太（FOTILE）核准的服务技术人员进行更换，以避免危险。
11. 在可能遭受蟑螂或其它害虫侵扰的一些国家的某些地区，应特别注意随时保持本电器及其周围处于清洁状态。由蟑螂或其它害虫所造成的任何损坏都将不涵盖在保修范围内。
12. 警告：在更换灯泡之前，请确保本电器已关闭，以避免可能发生的电击。

正确使用

注意事项：烧伤危险。本烤箱会产生高温。

1. 当将食物放入烤箱并对其进行翻转或移除时，以及在热烤箱内调整烤箱架或进行其它操作时，请务必使用烤箱手套等。应当格外小心，以避免自己被顶部加热/烧烤元件所烧伤。
2. 当烹饪的食物含有食用油或油脂时，绝对不得让本烤箱处于无人照看的状态，因为这些物质过热时会有火灾危险。
3. 不得使用本烤箱用于鲜花或药草的干燥处理。火灾危险！
4. 若食谱中使用了酒精，高温会导致酒精蒸发，甚至点燃加热元件。在将菜肴放入烤箱之前，必须先将酒精蒸发掉，以避免这一危险。
5. 放在烤箱内进行保温的食物必须盖好。食物中的任何水分均可能导致烤箱内发生腐蚀损坏。这也是为了防止食物变干。
6. 如您打算使用烤箱的余温来完成一个烹饪过程，则应将功能选择器留在之前所设定的位置上，并将温度选择器调到最低设置。在将食物移除之前，不要关闭本电器。烤箱中水分的增加可能会导致凝结水的形成，凝结水可能会导致炉室发生腐蚀，并且损坏控制面板、操作台和周围的厨房家具。
7. 绝对不要在烤箱的底部铺上铝箔。这样会导致热量集中，从而导致烤箱底部发生损坏。由于这一原因，不得直接将餐盘、锡盘或烤盘放在烤箱的底部。
8. 绝对不要向热烘烤盘上的食物加水或直接向热烤箱内的食物加水。产生的蒸汽可能会引起严重的烧伤或灼伤，而且突然的温度变化会损坏搪瓷。
9. 始终确保食物得到了恰当的烹饪或再加热。一些食物可能包含至少在70°C以上烹饪10分钟才可被完全杀死的微生物。因此，当烹饪或再加热食物时，比如家禽，将食物完全煮熟透尤其重要。如存在疑问，则选择更长的烹饪或再加热时间。重要的是，热量应均匀地传递到正在烹饪的整个食物。这可以通过在烹饪的过程中对食物进行搅拌和/或翻转来实现。
10. 如使用塑料容器进行烹饪，则它们必须是已由制造商声明适用于烤箱的类型。其它类型的塑料容器在高温环境中会熔化，而且可能会损坏烤箱。
11. 不要在烤箱中加热未打开的罐头盒或食物罐头。压力会积聚，并且可能会发生爆炸，从而导致伤害或损坏。
12. 不要在烤箱底板上前后推拉锅碗瓢盆，因为这样可能会损坏表面。
13. 不要靠在或坐在开启的烤箱门上，或在其上面放置重物。烤箱门最多可承受15kg的负重。确保没有东西卡在门和烤箱室之间。这样可能会损坏烤箱。
14. 不要使用本电器来加热房间。由于高温辐射，放置在烤箱附近的物体可能会着火。
15. 当烤箱在加热时，请确保门已关闭。
16. 正确安装——确保该装置是由专业的技术人员安装。
17. 禁止使用该装置给房间进行保温或加热。
18. 禁止将儿童单独留置——禁止将儿童单独留在或将其在无人看管时留在装置运作的场所中。禁止儿童坐或站立在该装备的任意部件上。
19. 穿着恰当的服装——在使用装置时禁止穿着宽松或披风类的服装
20. 用户服务——除手册或应用指南特别推荐外，不要维修或更换装置的任何部件。所有其他服务应咨询专业技术人员。
21. 在装置中或上面储存——易燃材料禁止存放在烤箱里或靠近烤箱表面。
22. 禁止用水来浇灭油火——应隔绝空气闷熄火或使用干粉或泡沫式灭火器。
23. 只能使用干的隔热垫——湿的隔热垫接触热的表面可能会导致蒸汽灼伤。不要让隔热垫接触加热部件。不要使用毛巾或其他大布料。
24. 开门时要谨慎——在移动或替换食物前，要先让热气或蒸汽出来。
25. 禁止加热未拆封包装的食物——增加的压力可能会致使包装爆炸，引起伤亡。
26. 保持烤箱通风管道的通畅。

27. 炉架的放置——当烤箱冷却后，将炉架放到指定的位置。如果当烤箱热的时候，必须移动炉架，注意不要让隔热垫接触烤箱中任何热的零件。
28. “禁止触摸加热部件或烤箱的内表面——虽然加热件或烤箱内表面颜色已恢复为黑色，但是加热部件可能还会很热。烤箱的内表面的温度足以引起烫伤。在使用过程中或使用后，禁止触摸或使用布和其他隔热材料触摸加热部件和烤箱的内表面，直到烤箱充分冷却后再操作。装置的其他部件也可能引起烫伤——这些表面是（可识别的表面——例如，烤箱通风口或靠近烤箱通风口的表面，烤箱门和烤箱门上的窗口）

配件

请只在本电器上使用原装方太（FOTILE）备件及配件。如使用了来自其它制造商的备件或配件，这样会使保修失效，而且方太（FOTILE）也不会承担责任。针对由不符合这些警告和安全须知的操作而导致的损坏，制造商均不承担责任。

关爱环境

包装材料的处理

运输和保护包装已选用了环保且可正常回收的材料。

请确保所有塑料包装和袋子等均已获得了安全的处理，并避免婴儿及幼童接触。窒息危险！

请确保这些材料可获得回收，而不仅仅是将它们丢弃。

旧电器的处理

电气和电子设备中通常包含未经恰当处理或处置的话可能会给人类健康及环境带来潜在性危害的材料。然而，它们对于电器的正常运行也是必不可少的。因此，请不要随家庭垃圾处理电器。

请在当地社区的垃圾收集/回收中心将其处理，或联系经销商进行咨询。当存放起来进行处置时，应确保其不会对儿童造成危害。应将其电源插头拔掉，或由符合资格的人员将其与主电源断开。

应用指南

包装清单





1. 从包装材料中取出烤箱，并仔细检查烤箱是否完好无损。

- a. 烤箱是否受到重物的撞击或挤压？
- b. 烤箱门是否平整且开关顺畅？
- c. 根据包装清单，是否存在任何漏件或缺件？
- d. 电源线是否受损或松脱？

如您发现以上任何一种情况，请联系方太（FOTILE）的授权服务人员。

2. 包装清单

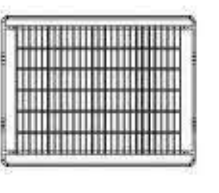
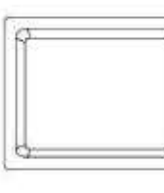
本烤箱提供下列配件：

物件	数量	图片	物件	数量	图片
嵌入式电烤箱	1件		烤具夹子	1件	
手册	1本		烤网	1件	
烤盘	1个		木螺钉&垫片 (用于安装)	4件	

部件名称

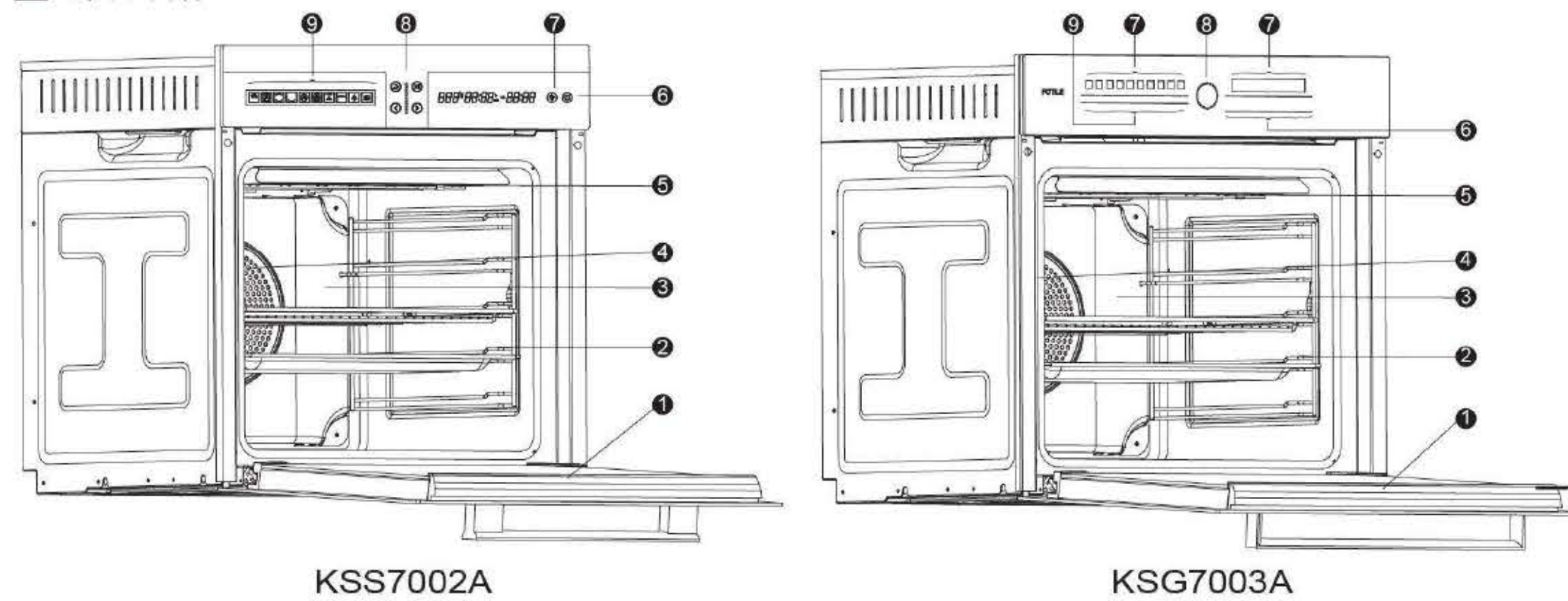

KSS7002A

KSG7003A

KSS7002A		KSG7003A	
1.门	6.电源	1.门	6.触键: ⊕ 定时器/时钟, 童锁, - 减, ok 确认, 🔔 闹铃, ☀ 照明, + 加.
2.右支架	7.灯键	2.右支架	7.触键: ↶ 返回, ⏸ 确认/暂停, < 减少, > 增加.
3.风机进风口背板	8.触键: ↶ 返回, ⏸ 确认/暂停, < 减少, > 增加.	3.风机进风口背板	8.电源
4.左支架	9. ⊕ 设置的烹饪时间, >> 烤箱开始工作, ↶ 设置的开始时间.	4.左支架	9.功能触键
5.顶部加热组件/烧烤元件(内部)		5.顶部加热组件/烧烤元件(内部)	



请根据您所购烤箱的具体型号参照匹配的描述。

技术资料

型号	KSS7002A	KSG7003A
额定电压	240V 60Hz	240V 60Hz
额定功率	3800W	3800W
产品尺寸(长X高X深)	23 7/16" x 23 7/16" x 21 3/4" (595X595X552mm)	23 7/16" x 23 7/16" x 21 3/4" (595X595X552mm)
烤箱容量	2.47cu.ft.	2.47cu.ft.
净重	88.2 lbs	88.2 lbs

特性

烤箱控制

烤箱控制用于选择烘烤、焙烧和烧烤的各种烹饪程序:

配备时钟/定时器的烤箱还具有下列特性:

- 时钟显示
 - 分钟记录
 - 自动关闭或开启并关闭烹饪程序的定时器
- 冷却风扇

当烹饪程序开始时,冷却风扇会自动开启。当冷却风扇将来自炉腔的热空气通过位于电器门和控制面板之间的通风口排出时,会先将其与室内冷空气进行混合。烤箱关闭之后,冷却风扇会继续工作一段时间,以防止湿气积聚在烤箱内、控制面板上或烤箱的外壳上。当烤箱内的温度已获得充分的下降时,冷却风扇将自动关闭。

首次使用的清洁和加热

新烤箱在首次使用时会有轻微的气味,而本节将说明在您用其烹饪任何食物之前如何将气味消散掉。在使用之前,请执行下列操作:

- 去除烤箱底板、烘烤盘和支架等位置的所有贴纸。
- 从烤箱中取出所有的配件并将它们清洗干净。
- 先用湿布将烤箱擦拭一遍。通过这种方式,可以去除掉在储存和开箱过程中可能已积聚在炉腔的灰尘或包装碎片。然后不加任何东西地将烤箱加热一遍。
- 将功能调到 ☀。
- 使用温度触键将温度调到最高。
- 至少让空烤箱加热一小时。在进行此操作期间,请确保厨房的通风良好。关闭通往其它房间的门,以防止气味弥漫至整个房间。
- 在时钟/定时器模式时,您可将该程序设定为自动完成,请参照相关小节。请务必等待,直至烤箱冷却至室温。然后使用热水和温和洗涤剂的溶液来擦拭炉腔,并使用干净的布将其彻底擦干。让烤箱门敞开着,直至烤箱内部已彻底干燥。

控制

功能设置 - KSS7002A

1) 启动:

按住红色触键“⏻”0.5秒钟,此时电源接通。

2) 烤箱设置:

- 启动之后,开关控制区域会亮起,而左边的烘烤模式区域图标会显示半亮。然后进入烘烤设置模式。

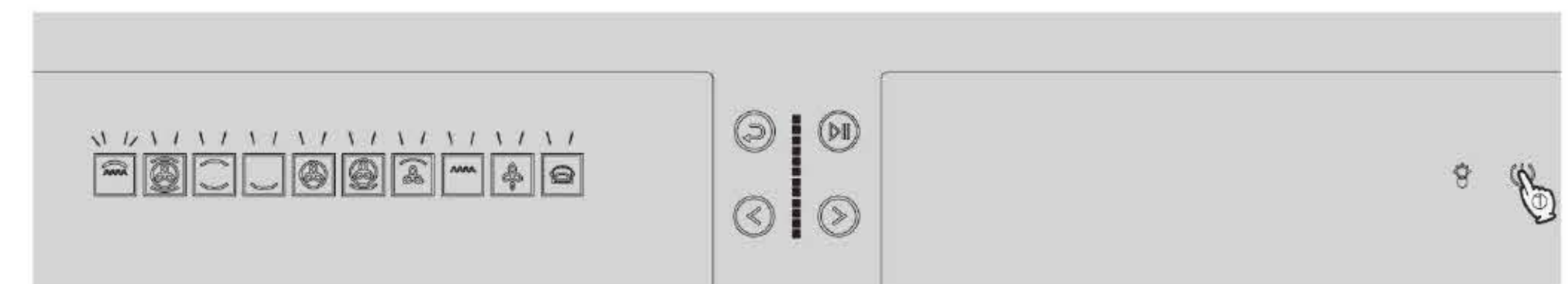

- 按方向键“<”或“>”来进行选择,相应的功能会显示高亮。返回键“↶”和确认键“⏸”复位。

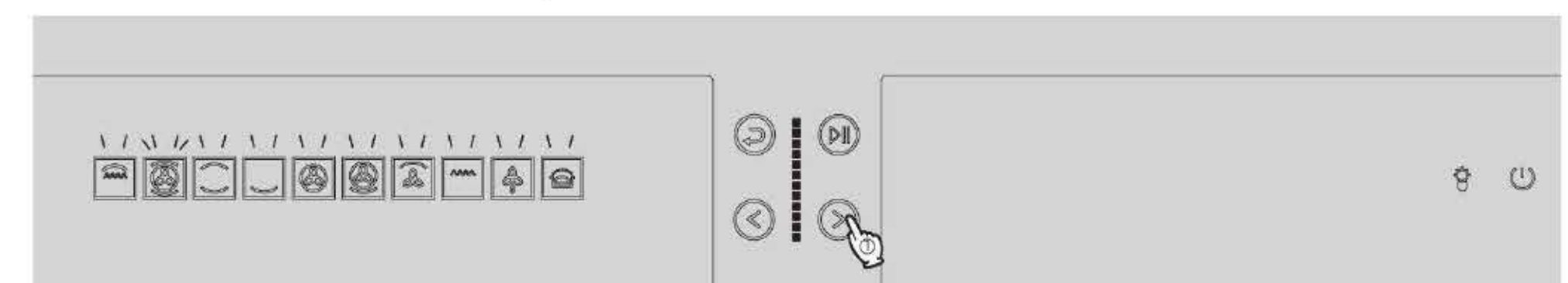

- 按“▶▶”，选定的模式将完全亮起，其它模式的图标将熄灭。

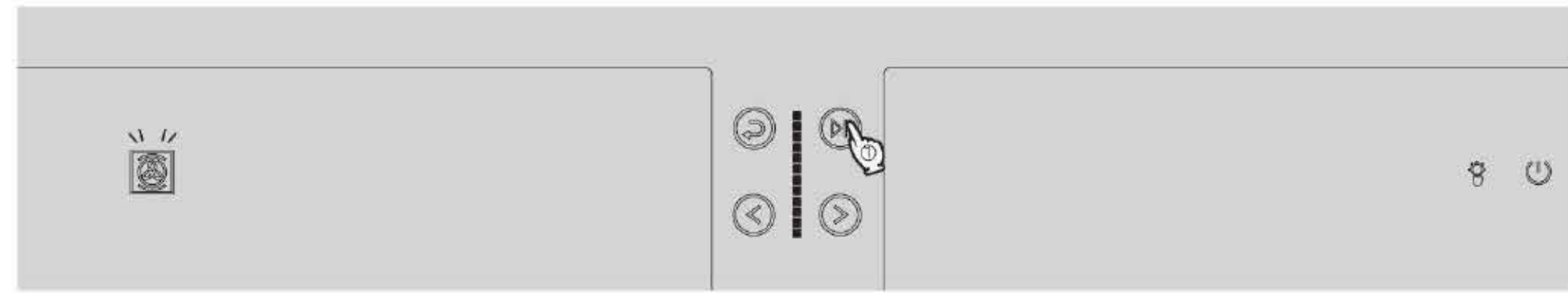

- 模式的选择完成之后，右边的区域将显示半亮。温度（默认显示为“160°C”）将亮起。然后进入烘烤温度设置模式。

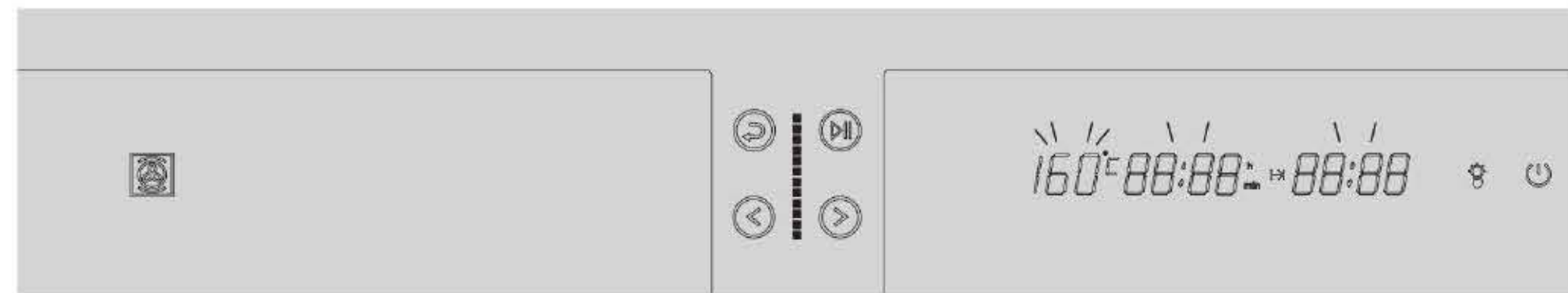

- 按方向键“◀”或“▶”来设置温度（1°C为1次跳跃，长按方向键，然后数字快读5°C一次跳跃）。当设置到恰当的温度之后，按“▶▶”；（例如，我们需要将温度设置为170°C）

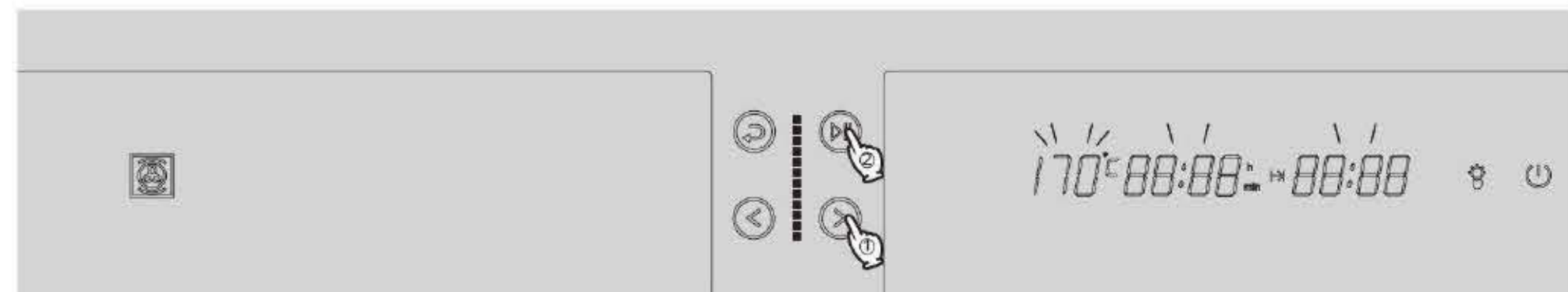
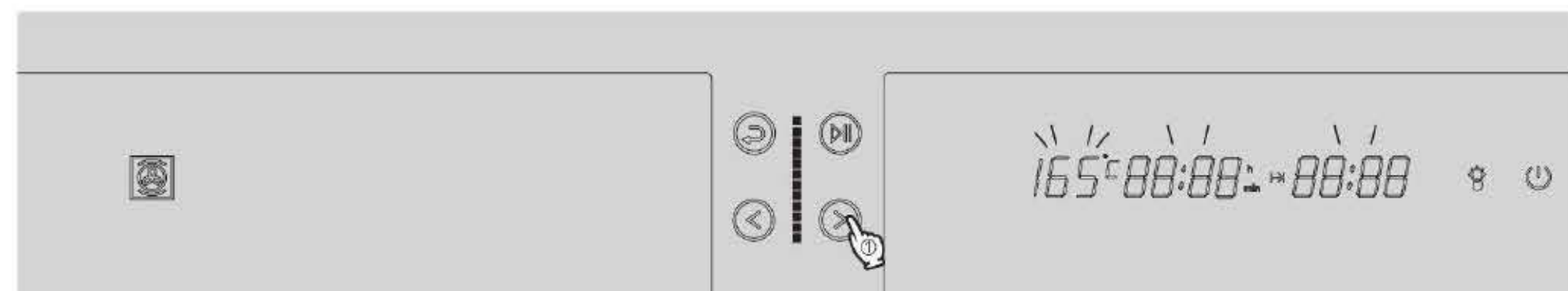

- 温度的设置完成之后，烹饪时间（默认显示为00:25）会亮起，然后进入烘烤时间设置模式。

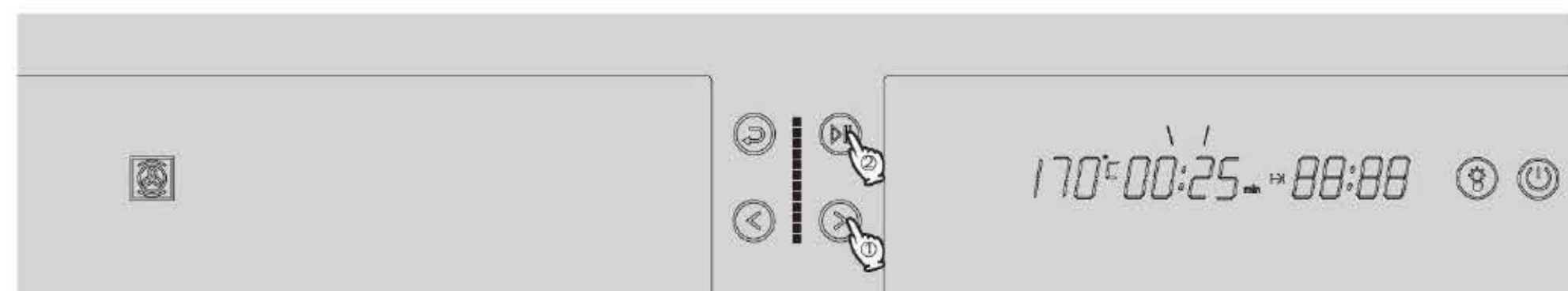

- 按方向键“◀”或“▶”来设置时间（一分钟为一次跳跃，长按方向键，然后数字就会快速地跳跃）。当设置到恰当的时间之后，按“▶▶”；（例如，我们需要将时间设置为30分钟）

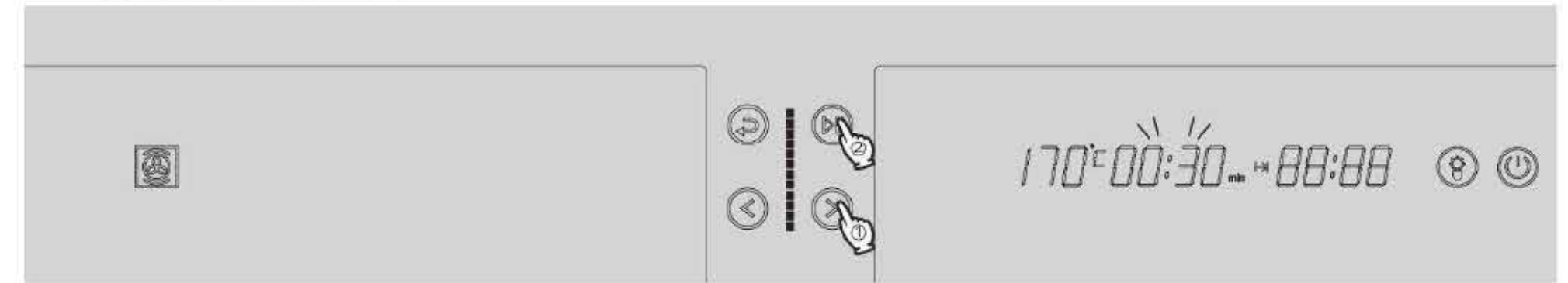

- 烘烤时间设置完成之后，预约时间会亮起（默认显示为00:00）。如需要预约，则进入预约时间设置模式。按方向键“◀”或“▶”来设置时间。长按方向键，然后数字就会快速地跳跃。当设置到恰当的时间之后，按“▶▶”进行确认。进入预约模式，此预约的时间为烤箱开始工作的时间。如不需要预约，则在设置烹饪时间之后按2下“▶▶”直接进入烘烤状态。

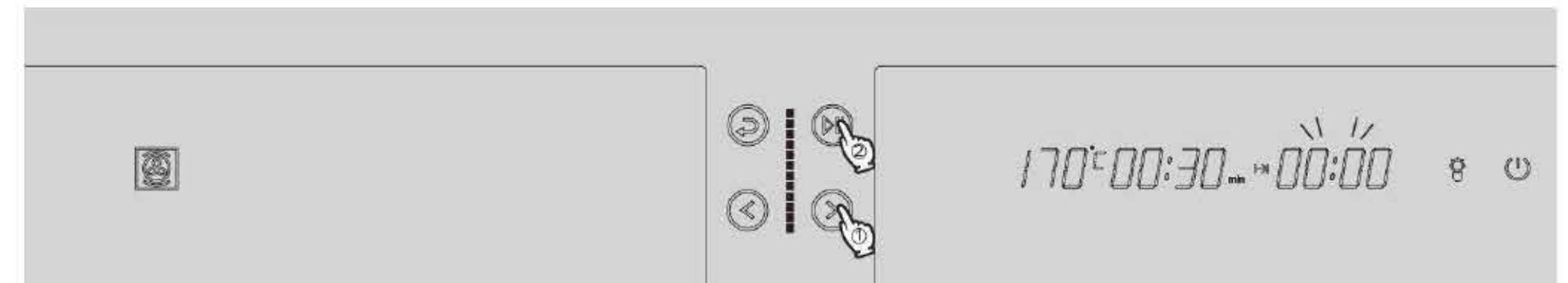

- * 无预约状态：发光条显示红色，当其到达设定的工作温度之后，工作时间开始倒数，发光条会显示橙色，而且有0.5秒的提示音；

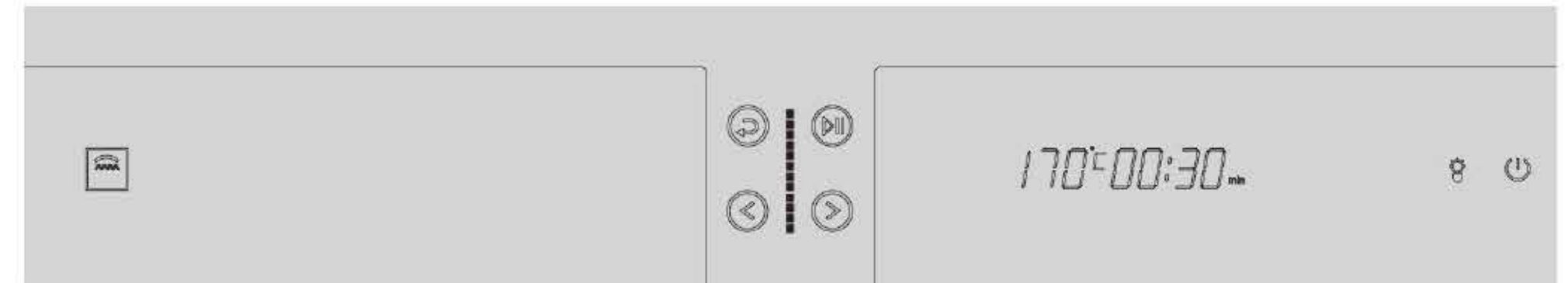

- * 预约时间状态：发光条不显示颜色，预约时间倒计时。预约时间到，进入工作状态（同无预约状态）。

- * 例如，我们需要设置30分钟的预约时间。

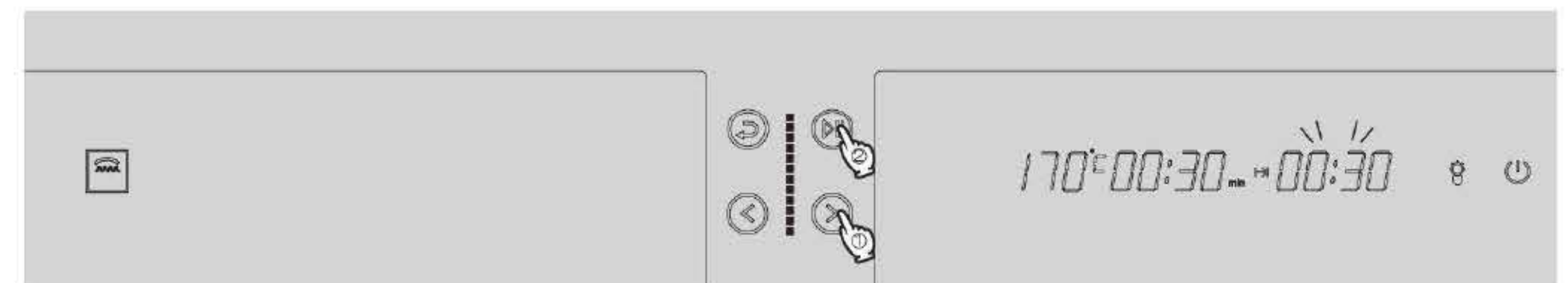

● 烘烤结束时:

* 当烘烤时间结束时, 会有一个提示音 (5秒多次) 来提醒您烘烤已经完成。

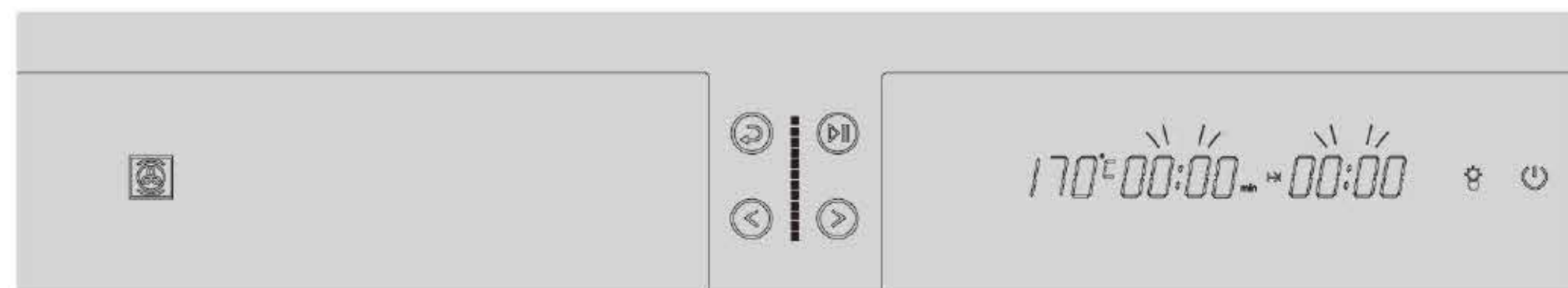

● 如您想暂停烘烤, 则按中心区域的“▶▶”。如您想重新开始工作, 则按“▶▶”让其继续工作。

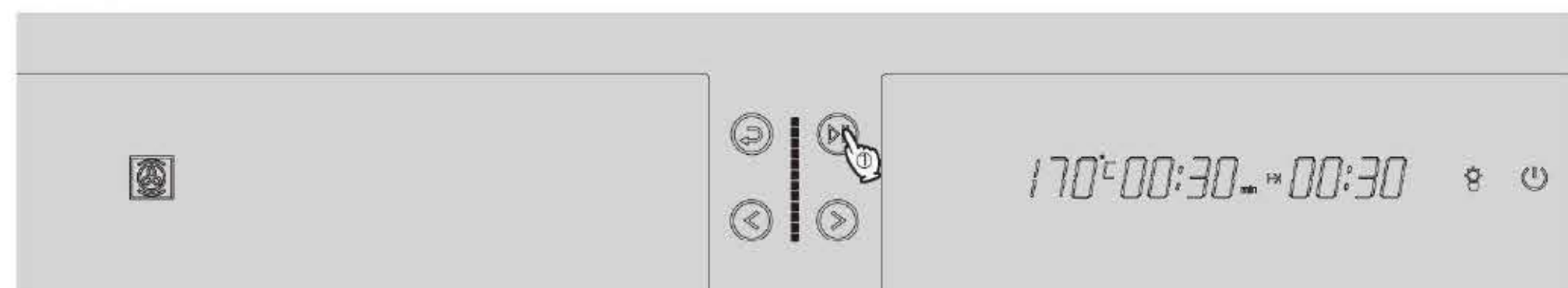

● 返回功能

当所有的参数已完成设置并且其正式开始工作时, 可按中心区域的“↶”来修改参数。按“↶”之后, 其将首先默认返回左边进行参数修改的模式区域。此时, 设置模式的光标开始高亮并闪烁。然后按“◀”或“▶”进行选择。再然后, 按中心区域的“▶▶”, 其将自动跳跃到右边的区域, 以修改温度、时间和预约开始时间。此时, 选择和确认方式与上述一样。

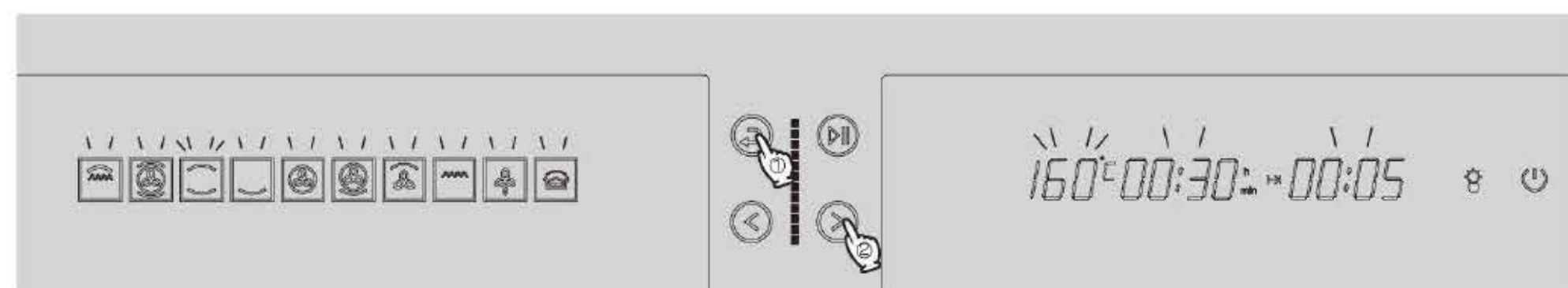

● 烘烤灯功能

烘焙过程中, 触摸右侧区域的“💡”, 烘焙灯亮起, 再按一下则灭掉。在设定参数时, 按任意键照明灯都会亮起。

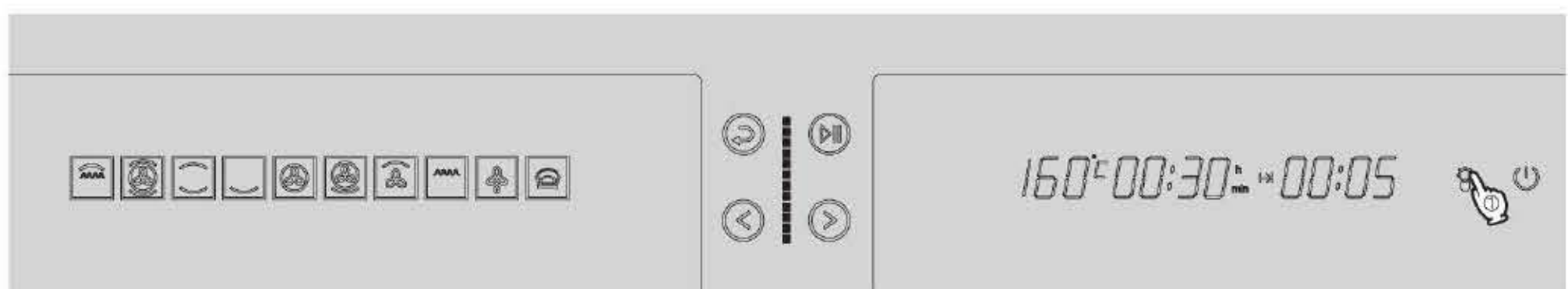

● 将华氏度 (F) 转换为摄氏度 (°C):

长按“🔄”来进行温度单位的切换。该设置在下一个工作中将得到默认。

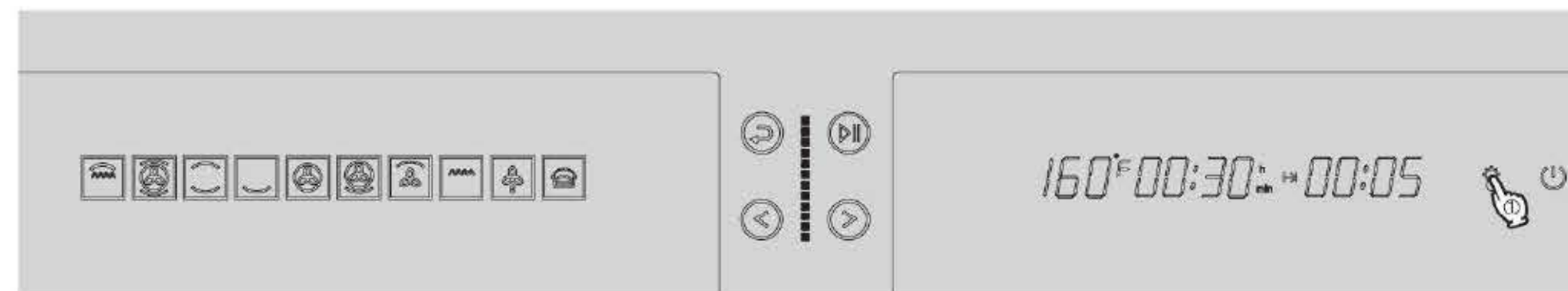

● 童锁功能

按住“▶▶”键3秒开启童锁功能, 同时, 所有键失效。再按“▶▶”3秒关闭童锁功能。

■ 功能设置 - KSG7003A

共有十个加热模式供选择。每个加热模式均有其对应的默认温度。

1) 触摸电源“○”键打开烤箱, 然后画面将显示如下。如不触摸任何键, 则2分钟后显示屏全部熄灭。

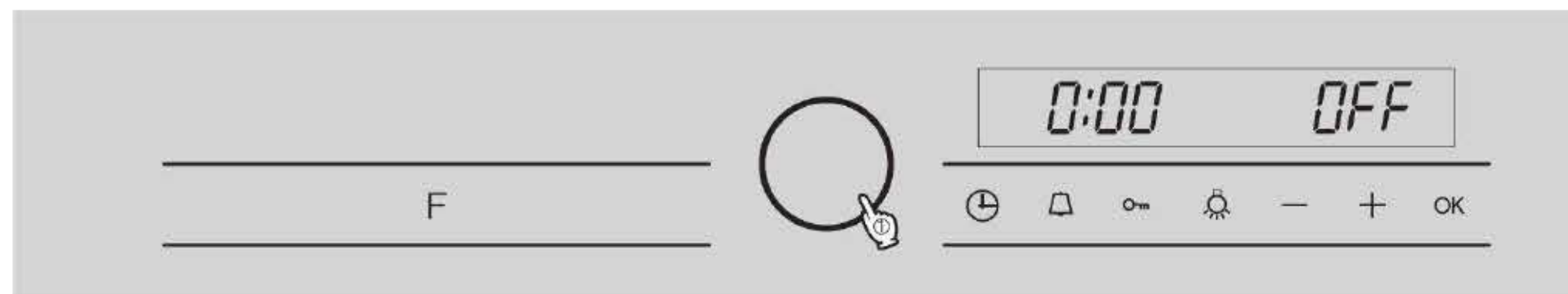

2) 触摸“F”键, 然后画面将显示如下。

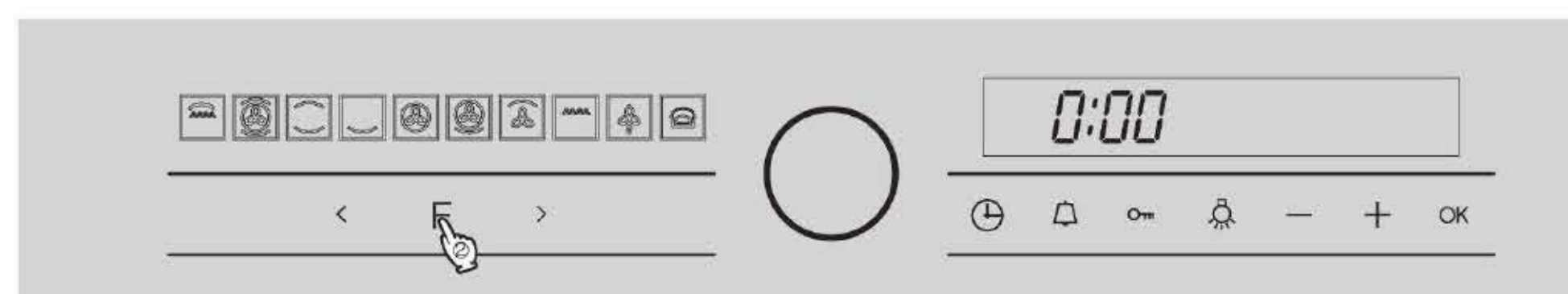

3) 然后触摸“F”附近的“<”或“>”来选择所需的功能, 图标会相应地亮起, 然后画面将显示如下。

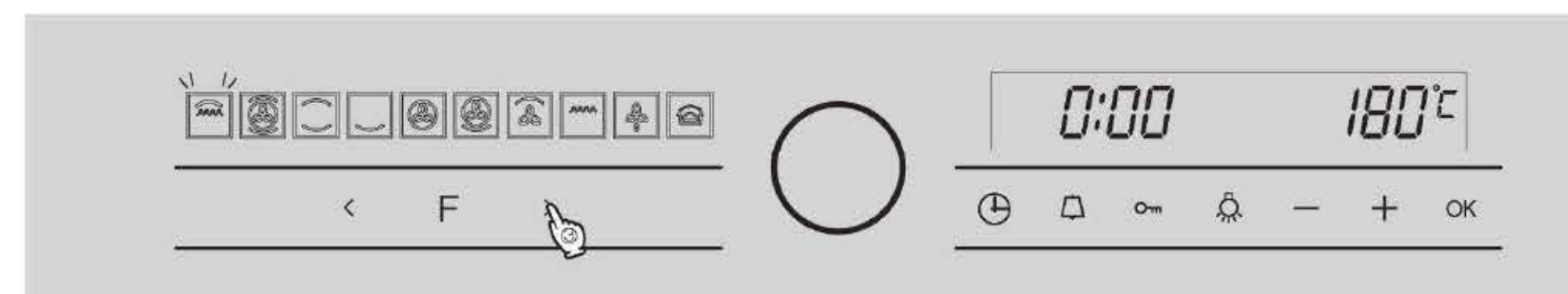

4) 轻轻地触摸“OK”键来确认您的要求，然后画面将显示如下。

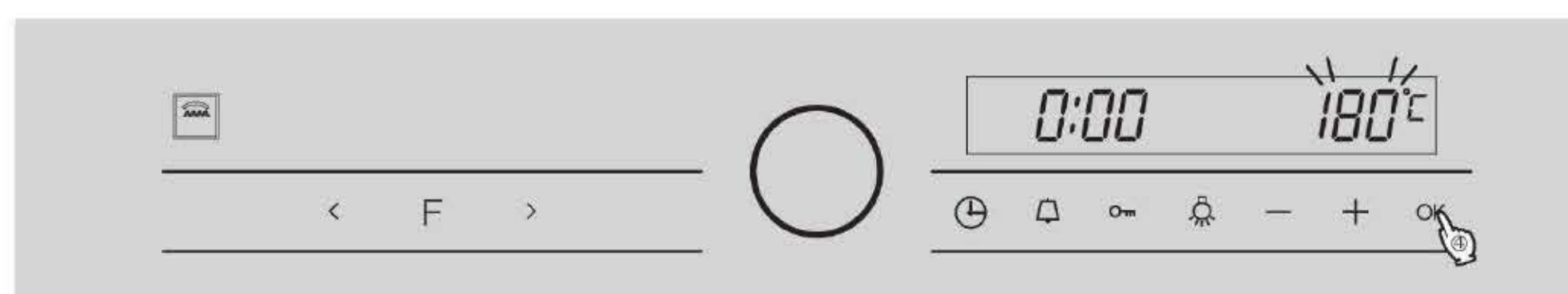

如您想修改设置，请触摸“F”键两次，然后重复步骤3)~4)。

温度设置

烹饪功能设置之后，设置所需的烹饪温度，因为每种烹饪模式均有其推荐的加热温度。请设置您想要的功能。参照“功能设置”。

1) 功能的设置完成之后，温度图标将立即闪烁，请触摸“-”或“+”来选择所需的温度（长按这两个符号5°C一跳）。参照以下画面：

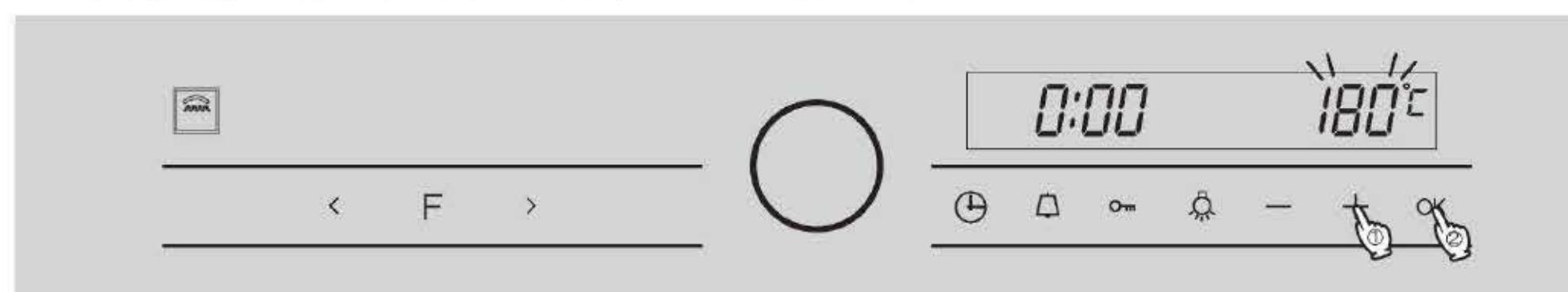

2) 请通过触摸“OK”键来确认所需的温度。
3) 烹饪程序设置完成之后，烤箱将立即开始加热。

1. 如您想修改设置的温度，请触摸“-”或“+”，并重复步骤3)。
2. “-”或“+”键的每次触摸将改变1华氏度(F)或1摄氏度(°C)的增减量。一直触摸这些键的其中一个将加速这一过程。

温度显示

烹饪程序设置完成之后，烤箱将立即开始加热，而且将显示烤箱内腔的温度。温度图标的旁边有一个温度进度条，其显示了腔内的实际温度和您设置的温度之间的差距。

同时触摸“-”和“+”，这样可以在华氏度(F)和摄氏度(°C)之间切换温度单位。

在加热期间，触摸“-”或“+”可看到设置的温度。
当到达设置温度时，可听到类似“滴”的一声。



烤箱内灯

“”可独立地打开烤箱灯。轻轻地触摸“”键，烤箱内的灯将打开。再次触摸它，该灯将关闭。在清洁烤箱时，这很有用。

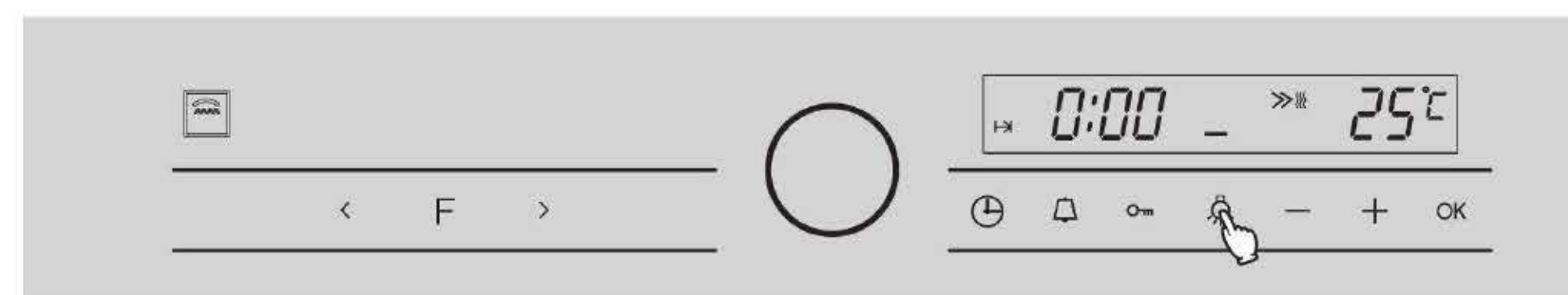

童锁

设置儿童锁：触摸按键“”之后会出现图标“”，除了电源键之外，其他键都处于无效状态。解开儿童锁：触摸按键“”三秒钟，然后图标“”将出现。

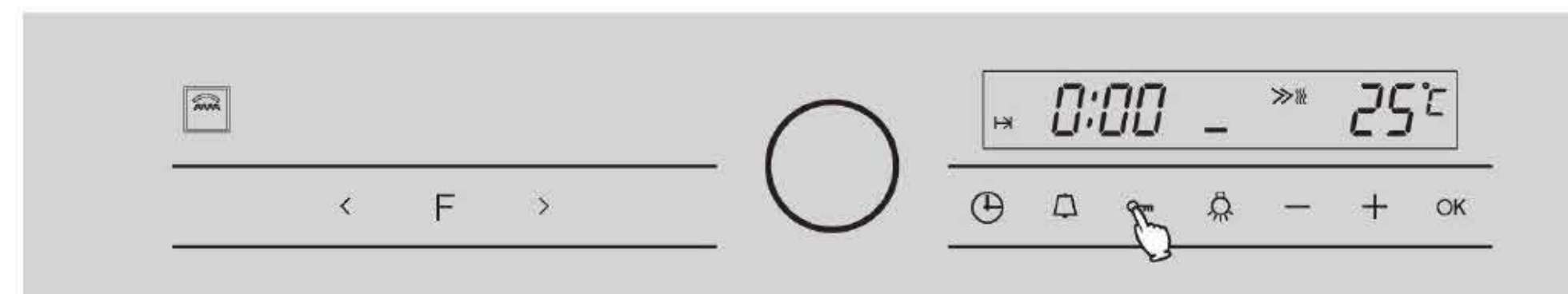

时钟/定时器

时钟/定时器可：

- 显示当日时间；
- 用于分钟记录；
- 自动关闭或开启并关闭烤箱。

控制

时钟/定时器通过“”、“”、“-”、“+”和“OK”键连同显示屏来操作。

按键	功能	按键	功能
	- 选择“烹饪时长” - 选择“当日时间” - 选择烹饪程序开始时间	OK	- 用来确认
	- 选择“分钟记录”	-	- 减少时间或温度
		+	- 增加时间

显示图标	含义	显示图标	含义
	已设置闹铃		烤箱开始工作
	设置的烹饪时间		设置的开始时间

操作

当您选择一种功能时，显示小时的图标会闪烁。当图标在闪烁时（大概6秒），您只能输入一个时间/时长。如您未能在6秒内完成输入，则您必须再次调用显示屏上的图标。

“-”或“+”键的每次触摸将改变1分钟或1小时的增减量。一直触摸这些键的其中一个将加速这一过程。

触摸“OK”键来保存您的设置。

在未进行烹饪的情况下，如显示屏已显示了超过两分钟，则显示屏会自动关闭，并切换到省电模式。

首次设置日期时间



将本电器连接到主电源之后，机械会发出类似“滴”的一声。显示屏会闪烁“0:00”六次，以提醒用户输入当前时间。请立即通过触摸“-”或“+”键来输入时间，然后触摸“OK”键来保存您的设置。

例如，设置八点钟，然后画面显示如下：

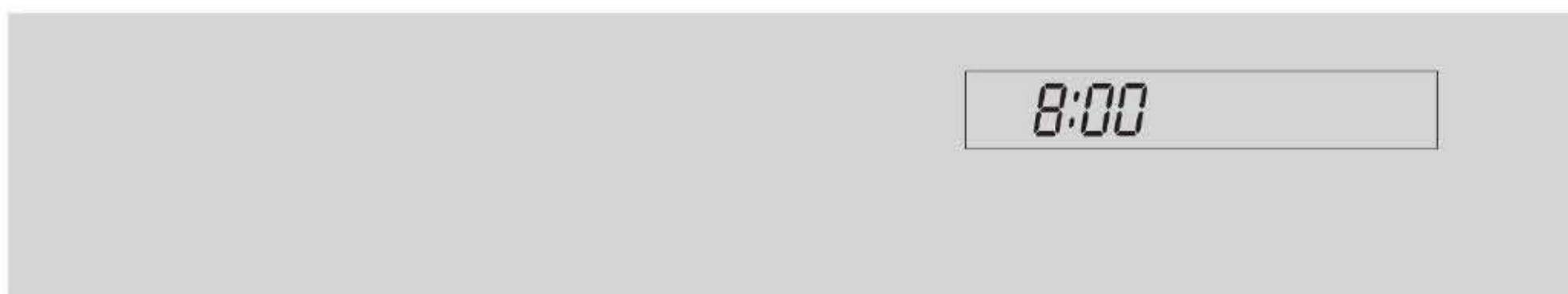

 如用户未在6秒内输入时间，窗口将显示0:00，然后时钟开始自动定时。

修改日期时间

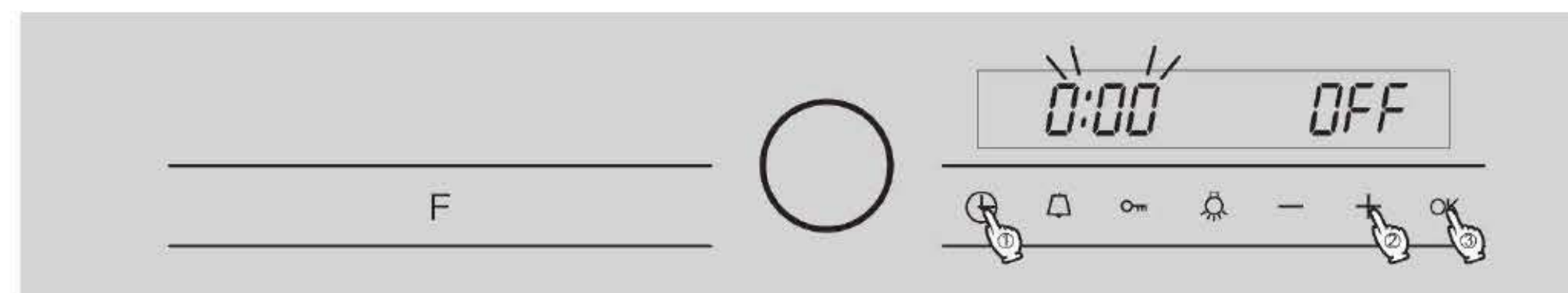

1. 触摸“⊕”键，显示小时的图标会闪烁，以提醒用户输入时间。
2. 触摸“-”或“+”键来设置小时。设置之后，按时钟键，转为分钟闪烁。如果不输入内容，请等待3秒钟，然后数字显示屏会自动切换到分钟设置。触摸“-”或“+”键来设置分钟。
3. 触摸“OK”键或时钟键来确认时间，或等待6秒钟，直至时间自动确认，然后图标会停止闪烁。

时钟可显示24小时。

定期器可倒数分钟。

如出现了断电情况，当日时间需重新输入。

 在烹饪期间或预置烧烤状态下，当日时间不可调整。

使用分钟记录

分钟记录可用于厨房内任何活动的定时，例如煮鸡蛋。

您可以同时为另一个定时程序设置分钟记录，例如作为涂烤油或加调料等的提醒。

分钟记录时间的输入可介于1分钟和23小时59分钟之间。

设置分钟记录

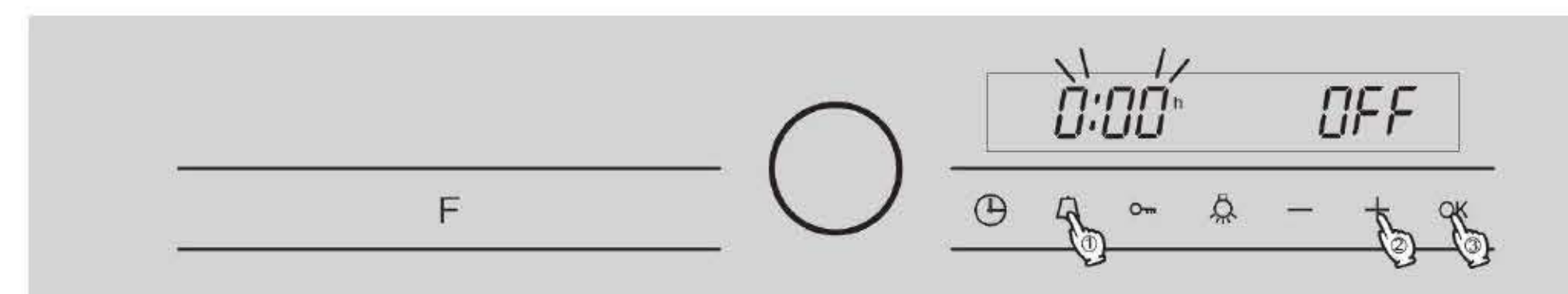

- 触摸“⏰”键，然后会显示“小时”图标。在时钟输入完毕后，按闹铃键转为分钟闪烁，当闹铃符号“⏰”正在闪烁时，输入所需的分钟记录时间。方法与“⏰”日期时间设置一样。
设置完成之后，显示屏会返回到显示当前时间。图标“⏰”继续可见，以作为分钟记录正在工作的一项提醒。
- 当显示当前时间时，用户可触摸“⏰”键并通过显示屏来查看剩余时间。6秒钟之后，显示会返回到当前时间。只要图标“min”正在闪烁，就可以修改分钟记录时间的设置。
- 取消分钟记录：当图标“min”正在显示屏上闪烁，可使用“-”或“+”键将分钟记录时间设置为“0:00”。分类记录时间删除之后，当日时间会重新出现在显示屏上。
- 分钟记录的时间设置结束之后
- 烤箱将响大概10次。
然后显示屏会显示当前时间。

 分钟记录可单独使用，也就是说，它的工作不会影响到其它功能。闹钟不随关机键取消，如果在关机状态下达到闹钟定时时间，蜂鸣器响，同时显示屏显示当前时钟，到达闹钟定时时间2分钟后，显示屏全部熄灭。

设置烹饪时长

加热模式和温度设置完成之后，烤箱将开始烹饪，最大烹饪时长为10小时。

对于配备时钟/定时器的烤箱，您还可设置烹饪时长，以使烤箱可自动地关闭或开启并关闭。当烘烤时，烤箱的工作时间不应设置过长。否则，面糊或面团会变干，而且膨松剂也会失效。

定时烧烤

将食物放置入烤箱。

设置所需的功能和温度。

- 触摸“⏰”键，图标会显示小时，然后图标“⏰”闪烁，以提醒用户输入烹饪时长。用户可触摸“-”或“+”键来调整小时。6秒钟之后，显示屏将自动切换到“分钟”设置或触摸时钟键进行切换，并且图标“⏰”将闪烁。请通过触摸“-”或“+”键来调整分钟。

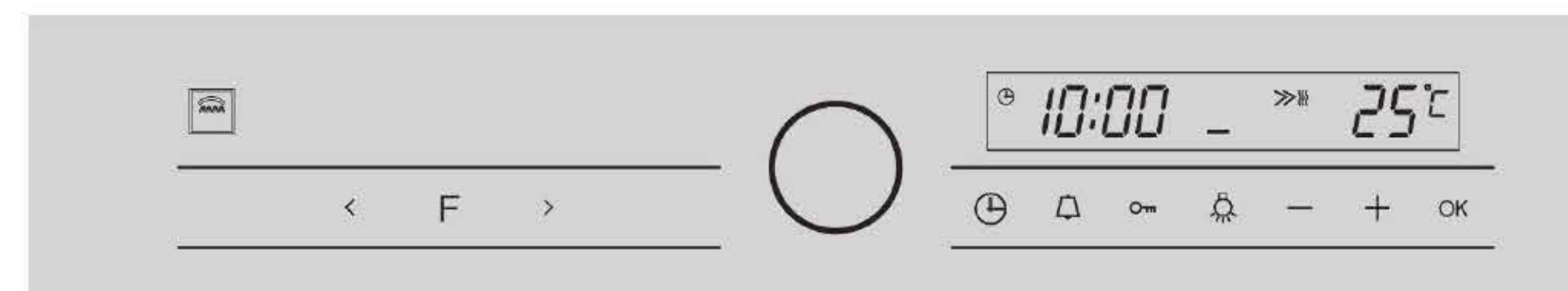

- 触摸“OK”键，烤箱将开始定时烧烤，显示屏将显示当前时间以及图标“🕒”和“▶▶▶”。
- 设置完成之后，触摸图标“🕒”，然后剩余时间会出现在显示屏上。6秒钟之后，它将返回到之前的状态。当闪烁时，您可调整时长，而且操作与设置一样。
如您想停止定时烧烤，请触摸“F”或“○”。
- 当烹饪结束时，加热也会停止。本电器将发出10次的哔哔声以提醒用户并显示当前时间。



最长的烹饪时长为10小时。当烧烤的持续时间在0和6之间时，图标“🕒”将出现。在定时烧烤时，触摸时钟键一下能修改定时时间。

预约烧烤：

将食物放置入烤箱。

设置所需的功能和温度。

- 触摸“🕒”键一次，以输入烧烤时长。它与定时烧烤的设置一样。
- 再次触摸“🕒”键，则预约开始时间和开始图标闪烁。触摸“+”键来设定烘烤的开始时间，此时无法触摸“-”，也就是预约开始时间一定大于显示的时钟时间；触摸“OK”键确认，则开启预约烧烤，在预约时间达到前，烤箱显示屏显示时钟时间。在到达预约时间后，烤箱显示屏显示定时时间，在预热结束后（达到设定时间），开始倒计时。

注：如不触摸“OK”键确认，则预约图标一致闪烁，已提示提醒，设置温度值显示。

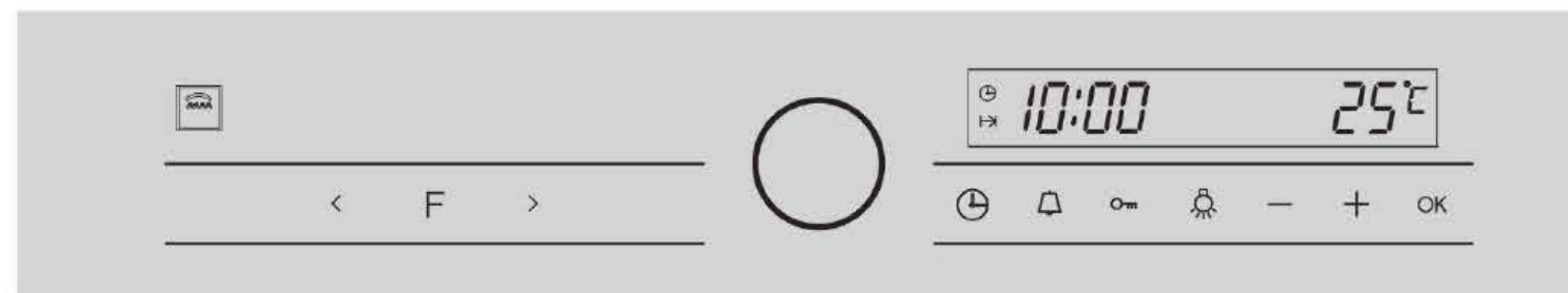

- 设置完成之后，触摸“🕒”键两次，它将显示结束时间，而6秒钟之后，它将返回到之前的状态。
当闪烁时，您可调整时间，而且操作与设置一样。
触摸“🕒”键一次，它将显示您设置的加热时长，而6秒钟之后，它将返回到之前的状态。
当闪烁时，您可调整时间，而且操作与设置一样。
如您想停止预置烧烤，请触摸“F”或“○”。
- 当烧烤结束时，本电器将发出10次的哔哔声以提醒用户。随后显示当前时间。



从时间设置点到完成时间点，可设置的最大时长为23小时59分钟。











烤箱功能

■ 烤箱功能

您的烤箱拥有十种功能模式供选择。

顺时针序列	图标	理想的烹饪功能	备注
1		顶部加热，适用于制作使用其它器具烹饪的食物的黄金表面。例如，满盘的面条、马铃薯、芝士及各种香肠食物。	效果类似于使用顶部的加热元件进行烹饪。直接将温度设置到食物表面所需的最高温度。将烧烤架放到“3”及“4”上。将食物放到烧烤架的中间。
2		同时快速地烧烤几个烧烤架上的食物。适用于体积较大的肉类。可保留原有的风味。就像一个电转烤肉架，适用于体积较大的肉类。	效果类似于使用背部加热元件连同上部和下部的加热管和风机进行烹饪；最多可同时使用两个烧烤架。
3		将烤箱预热到所需的温度，适用于烹饪体积较大的食物（比如蛋糕）。将食物放置到烤箱的中间。	效果类似于同时使用上部和下部加热元件进行烹饪。仅可使用一个烧烤架，否则，热量可能不会均匀分配。
4		适用于脆皮蛋糕和比萨饼，以及保存热量。	效果类似于使用下部加热元件进行烹饪。将温度设置到40°C，以保留已煮熟食物、面团发酵和酿造葡萄酒所需的热量。
5		适用于各种食物，尤其是冷冻食物。可保留原有的风味。烹饪时间较长，但更加美味。	效果类似于同时使用背部加热元件和风机进行烹饪。当温度设置为40°C时，它可用于解冻肉类，即使是在冬季。
6		适用于烹饪比如萨饼、奶酪饼干和水果派等应烹调过度的食物。	效果类似于同时使用背部加热元件和下部加热元件进行烹饪。
7		适用于制作香脆食物。	效果类似于使用上部加热元件和风机进行烹饪。
8		适用于小块食物（比如牛排），以节省能源。	效果类似于使用上部和中部加热元件进行烹饪。
9		解冻	
10		发酵	将揉好的面团放入一个容器，并使用保鲜膜盖住。然后将该容器放到位于第二拉格的烘烤盘上。加入200ml的一碗水，并选择“🍞”模式。设置时间之后，它将开始工作。

■ 烹饪建议

序号	模式	典型食物	重量(kg)	温度范围(°C)	时间范围(预热后)	层数
1		曲奇饼干	0.25	140-160	20-30	2
		戚风蛋糕	0.5	150-160	30-50	2
		面包	0.5	160-220°C	15-40	2 or 3
		塔&派	0.5	170-190°C	20-60	2
		泡芙	0.5	190-210°C	25-45	3
2		纸杯蛋糕	0.5	160-180	20-35	2
		吐司	0.5-1	150-170	35-55	2
		海绵蛋糕	0.5	150-160	30-50	2
		羊肋排	1-1.5	190-210	20-30	3
		松饼	0.5	180-190	15-25	3
3		披萨	0.5	190-210	10-30	2
		蛋挞	0.5	180-200	15-30	2
4		肉片	0.5	180-200	10-25	3
		蔬菜串	0.5	160-180	15-25	3
		肉串(少量)	0.5	190-210	10-25	3
5		鸡翅	0.5	160-180	15-30	2
		鸡腿	0.5	160-180	20-30	3
		烤鱼	0.5	180-200	20-30	2
6		肉串	0.5	190-210	10-25	3
		香肠	0.5	150-170	15-25	3
7		面包发酵	0.5-1	35-45	40分钟-4小时	2
8		牛肉干	0.5	70-100	90-150	2 or 3
		虾干	0.5	70-100	90-150	2 or 3
		果脯	0.5	70-100	90-150	2 or 3
9		适合吐司片、馒头片、披萨、煎饼等底部加热上色，复热，煎烤				
10		肉类		35-60	20-40	2
		鱼类		35-50	20-40	2

保养清洁



不要使用蒸汽清洁器来清洁本电器。蒸汽可到达电气元件，并引起短路。

■ 电器正面和控制面板

清洁

- 控制键；
- 门把手；
- 门的内饰；
- 定期清洁电器门和烹饪室之间的密封装置，而且每次使用完之后应优先清洁。这样可以防止油脂和其它沉积物粘附在表面，变得难以去除，而且在一些情况下，也会引起变色。油脂沉积物还可使密封装置变脆和破裂。

1. 所有的表面和控制键均应使用温水和含有一点洗涤液的软海绵或布进行清洁。

2. 使用软布将表面擦干。

不要使用精练剂、硬海绵、刷子或尖锐的金属工具来清洁玻璃，因为它们会刮伤玻璃的表面。

为了防止对玻璃、不锈钢和铝制面板电器的表面结构造成刮伤和损坏，请特别注意下列清洁说明。

■ 玻璃门面电器

电器正面和控制键对刮伤和摩擦非常敏感。

应避免：

- 具有研磨性作用的清洁剂，例如粉末清洁剂和乳霜清洁剂；
- 具有研磨性作用的海绵，例如之前曾用于具有研磨性作用的清洁剂的锅刷或海绵；
- 尖锐的金属工具；
- 烤箱喷雾。

■ 不锈钢门面电器

电器正面和控制键对刮伤和摩擦非常敏感。

不锈钢表面可使用布或针对不锈钢特别设计的专用无研磨性清洁剂。需要注意的是，不要在控制键上使用不锈钢清洁剂。

应避免：

- 含有苏打、酸性和碱性的清洁剂；
- 具有研磨性作用的清洁剂，例如粉末清洁剂和乳霜清洁剂；
- 具有研磨性作用的海绵，例如之前曾用于具有研磨性作用的清洁剂的锅刷或海绵。

■ 配件

当使用烤箱时，为了获得最佳的效果以及将所需清洁的托盘保持在最低的程度，请移除不需要使用的所有配件、托盘和支架。

■ 正常污渍

每次使用完之后，尽快使用抹布、软海绵或软尼龙刷以及温水 and 一点清洁剂的溶液进行清洁。污渍停留的时间越长，它就变得越难去除。

■ 顽固污渍

顽固污迹，例如来自烧烤的污迹，可能需要先使用湿海绵进行浸泡，以将其软化。如有必要，可使用针对玻璃表面的无研磨性不锈钢螺旋垫或刮板将其去除。

使用干净水彻底清洗干净之后，水必须很容易地在表面产生径流。任何残余的清洁剂都会阻碍该效果。



- 1) 当烤箱或托盘还有余温时，最好将溢出的汁和蛋糕混合物这些污迹去除。实际操作中要小心，确保烤箱已不热 - 灼伤危险！溢出的果汁可在表面造成持续的变色，而烧烤则会引起无光泽区域的出现。请依照上述指引进行清洁，不要尝试使用蛮力将其去除！这一变色是永久性的，但不会影响到搪瓷的效率。
- 2) 当烘烤高盐含量的物品（比如椒盐脆饼）时，将它们放置于烤盘或烤锅的烘焙纸上。钠沉积物会对搪瓷表面造成持久性的变色。

■ 烤箱内部

在清洁之前，先让烤箱冷却下来。

灼伤危险！

每次使用之后，应清洁烤箱的内部（包括左/右支架）以及门的内侧。如果没有这样做的话，来自烘烤和烧烤的污迹随后会越来越糟糕，从而让清洁变得更加困难。在极端的情况下，污迹将会变得难以去除，或甚至对表面的材料造成损坏。

搪瓷表面应使用温水清洗。请不要使用具有腐蚀性和研磨性的物质，它们会造成表面不可修复性的损伤。也不能用尖硬的工具去摩擦搪瓷表面。

在烤箱口四周围，有一个橡胶密封圈，应经常性地对其进行检查。如有必要时，应对其进行清洁，但不要使用具有研磨性作用的洗涤剂。

如其遭受损坏，请与本公司当地的售后服务中心联系。

在该密封圈得以更换之前，不应使用该烤箱。

为了使清洁变得更加容易，您可以

- 移除烤箱门；
- 拆除烤箱门。

关于这项操作，本章中有进一步的指引。

■ 移除烤箱门



烤箱门比较重。当移除或重装时，应从侧面将其抓牢。烤箱门通过铰链连接到烤箱上。在移除烤箱门之前，必须先松开铰链两端的锁紧夹。

- 将门完全打开（图1）。
- 松开铰链上的锁紧夹，然后将它们向上翻，直至它们处于一个翻不动的角度为止（图2）。
- 向上提升门，直至提不动为止。从两边牢固地抓住门，然后向上提升铰链（图3）。



- 1) 为了避免事故和伤害风险，当门还处于水平位置时，请不要试图将其取出。
- 2) 为了避免事故风险，请不要通过手把将门提起。
- 3) 请确保您从两边同时将门提起。

■ 重装烤箱门

- 从两边牢固地抓住门，并小心地将其装回到铰链上。请确保门和铰链之间未有空隙（图4）。
- 将门完全打开。
- 翻转回两个锁紧夹，直至翻不动并且处于水平位置为止（图5）。



为了避免铰链松脱、事故和损坏风险，当将门重装并进行清洁之后，请确保锁紧夹牢固地锁紧。

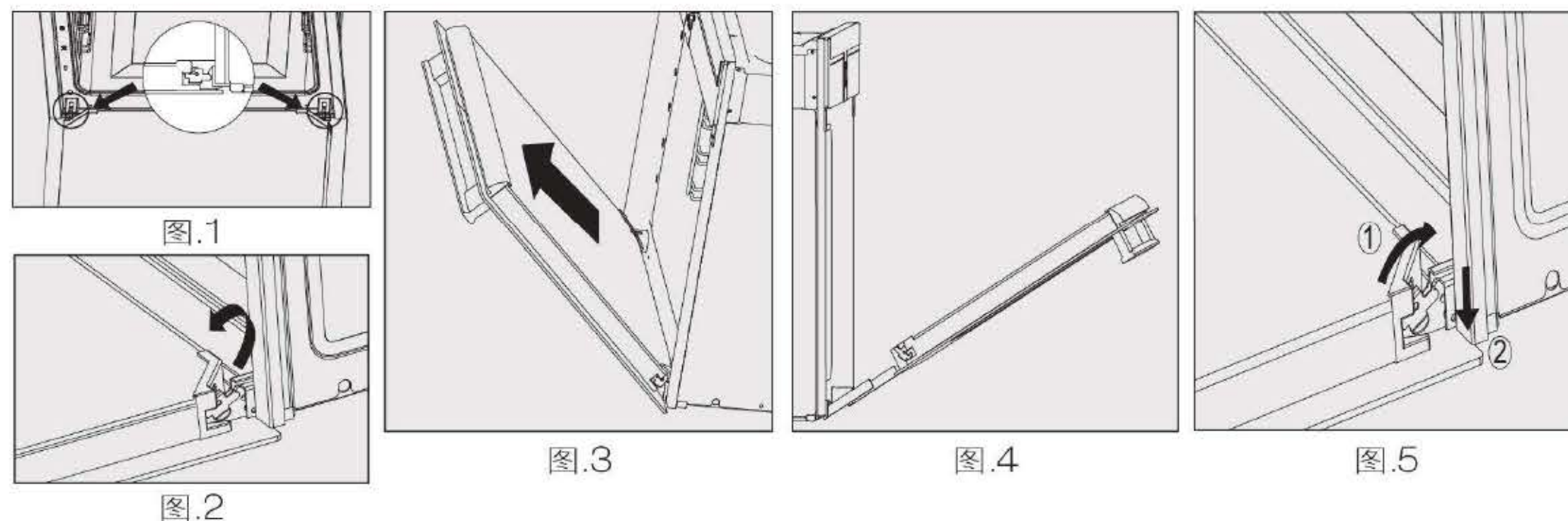

问题解决指南

严格依照现行的国家和地方安全法规，维护和修复只可以由具有资格的人员来进行操作。

由其他人员进行修复可能存在危险。

在下列指南的协助之下，小问题可轻易地解决。如不能解决，请关闭电源，然后联系我司客户服务中心。

问题	可能的原因和解决方法
烤箱不加热	- 检查所需的温度及功能是否已设置。 - 检查电源保险丝是否已跳闸。如已跳闸，请联系具备资格的电工或方太（FOTILE）客户服务中心。
烹饪之后可听到噪音	这不是故障。 烤箱关闭之后，冷却风扇会继续运行一段时间，以防止任何湿气积聚在烤箱内、控制面板上或外壳上。当温度已获得充分的下降，风扇会自动关闭。 将烤箱门打开，温度的下降会更快。
根据提供的表格设定时间之后，未能恰当地烹饪食物	- 检查是否已设置了正确的温度。 - 检查支架/托盘的位置是否正确或架子是否水平。
焦化不均匀	总是会有轻微的不均匀。如果焦化非常不均匀，请检查： - 设置的温度是否太高。 - 架子是否使用了正确的水平面。
“⏻”正在闪烁 “→”正在闪烁	可能的原因是您忘记了触摸“OK”键。

如发生任何您不能自己解决的故障，或如电器尚在保修期内，请联系

- 您的方太（FOTILE）当地经销商

当联系客服中心时，请提供您的电器的型号和序列号。这些数据会显示在烤箱顶部可见的参数标牌上。

安装烤箱

■ 电气连接

安装程序必须检查：

1. 主电源的电压和频率是否对应于电器的铭牌上所示的参数。
2. 电力装置是否可承受电器铭牌上所示的最大功率。
3. 根据现行法规，电气连接是否具有足够的接地。
4. 在紧急情况、清洁或更换灯泡时可，需切断电源。
5. 接25A电流的空气开关。
6. 进行电气连接后，检查烤箱所有电气部件是否正常工作。

7. 制造商不对因由非专业人员或不符合当地法规引起的安装错误而造成的任何直接或间接损害负责。

8. 接线示意图如下：

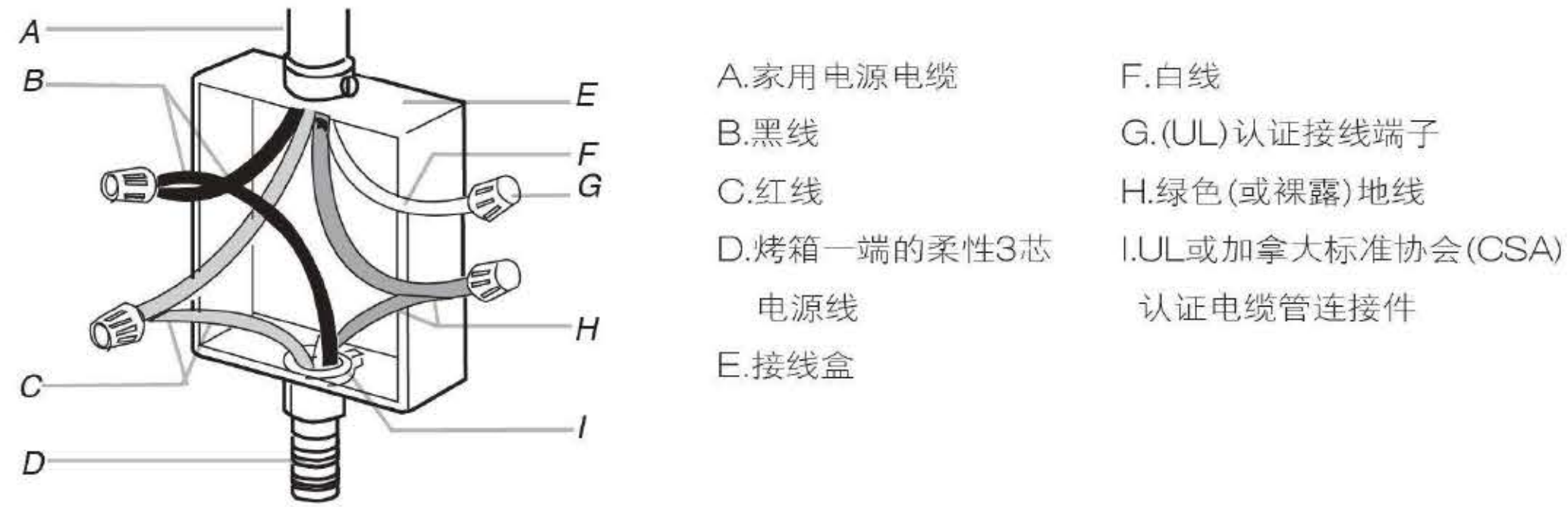

- 使用UL认证的接线端子，将2根黑线连接在一起(B)。
- 使用UL认证的接线端子，将2根红线连接在一起(C)。
- 使用UL认证的接线端子，将烤箱电源线中绿色(或裸露)的地线与接线盒中绿色(或裸露)地线接在一起(H)。
- 安装接线盒盒盖。

■ 安装烤箱

在使用之前，必须将烤箱嵌入。否则，它可能会引起电击危害。

不要在外壳内安装绝缘材料。这样会阻碍空气进入电器。

安装烤箱时，请将插头拔出。

全嵌

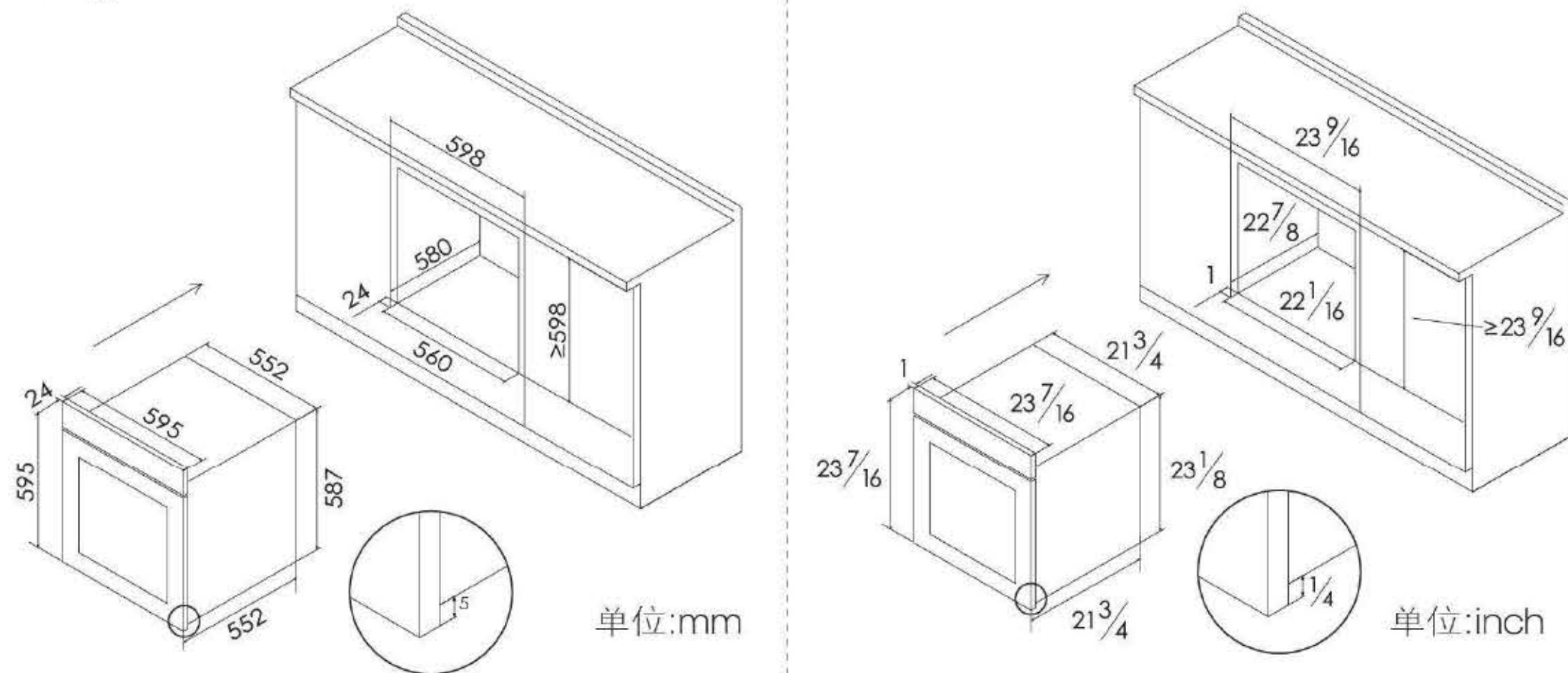

半嵌

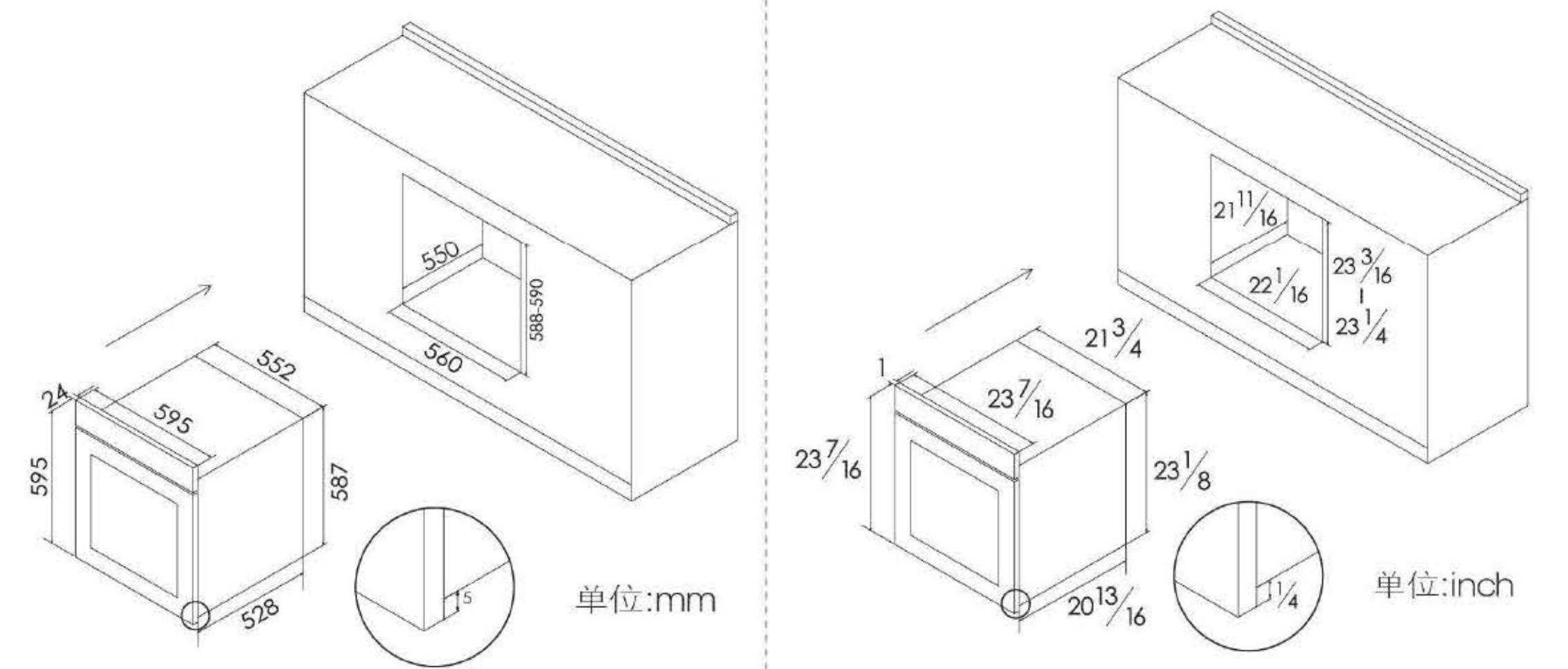

将烤箱门打开后，使用两枚螺丝钉通过烤箱护板上的孔洞，将烤箱门固定到外壳的侧壁上。重新连接电源至独立开关。

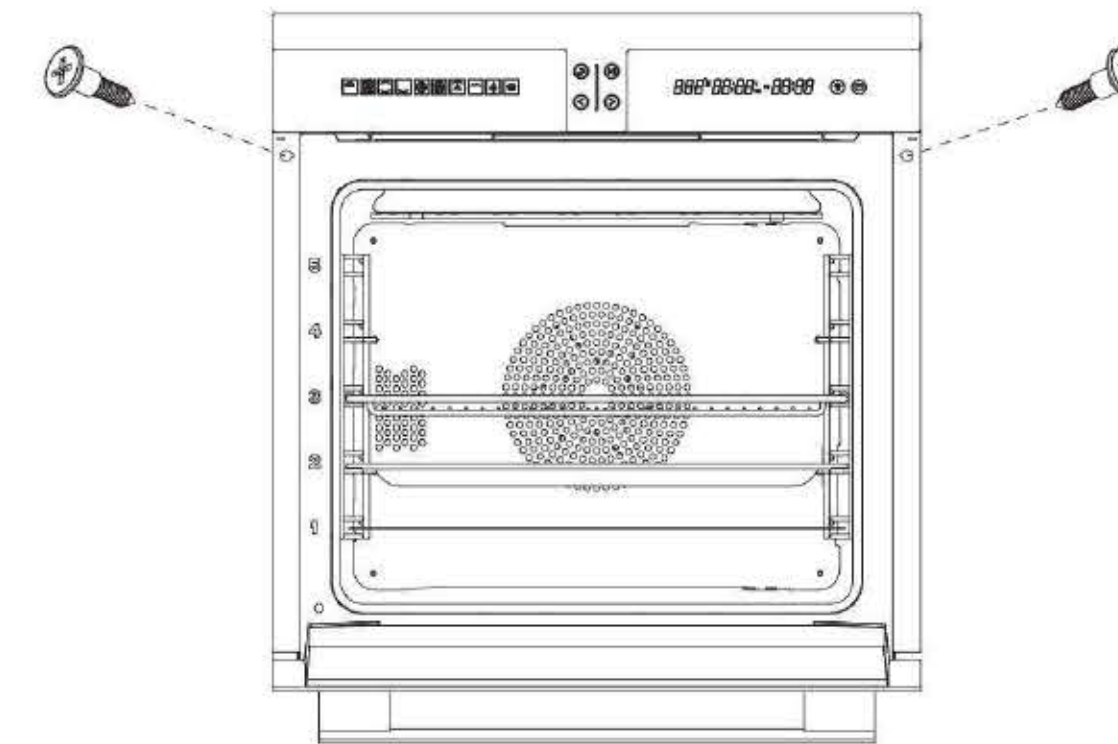

- 为了保护表面涂层，当拧紧螺丝钉时，应放置橡胶圈。
- 烤箱应平稳安装在操作、保养方便且牢固的地方，不得倾斜安置。
- 严禁将烤箱及电源插座安装在可能受潮或容易被水淋湿的地方。
- 搬运位置时应从拉手孔或底部抬起，轻搬轻放，切不可通过拖拉门体或把手来移动烤箱。
- 本烤箱是嵌入在橱柜内的，橱柜孔的底板必须坚固能承受60kg以上的重量。
- 安装烤箱橱柜的材料必须耐温120°C以上的。
- 为保持通风，请保持该橱柜的后部有大于45mm的空隙。