

Model: ILG-255



Portable Power Wheelchair

Owner's Manual



Contents

I. INTRODUCTION.....	2
II. GUIDANCE FOR USE.....	3
III. PRODUCT SAFETY SYMBOLS.....	4
IV. TECHNICAL SPECIFICATIONS.....	5
V. FEATURES.....	6
VI. ELECTROMAGNETIC INTERFERENCE WARNING.....	8
VII. SAFETY.....	9
VIII. INSTALLATION GUIDE.....	16
IX. OPERATION GUIDE.....	18
X. BRAKING.....	21
XI. BATTERY.....	22
XII. UNFOLDING AND FOLDING.....	26
XIII. TROUBLESHOOTING.....	30
XIV. WARRANTY.....	32
XV. PACKING LIST.....	34

I .Introduction

Thank you for choosing the iLiving USA Power Wheelchair, your effortless travel companion. The wheelchair is ultra-compact, light-weight and portable allowing for comfortable travel, compact storage and increased accessibility in your daily life. The wheelchair is designed to fold in just seconds thus increasing travel opportunities and allowing for compact storage. The wheelchair will allow you to go wherever and whenever you choose!

Your safety is iLIVING USA's utmost priority. Please read and follow all instructions in this owner's manual carefully before operating your power wheelchair for the first time. For your own safety, it is crucial that you completely understand the instructions given in this owner's manual.

iLIVING USA is not liable for any property damage or bodily injury which may occur as a result of improper use of this power wheelchair or failing to follow the instructions in this owner's manual.

If you have trouble comprehending the warnings and instructions contained in this manual, please contact your distributor, or your provider or the manufacturer. We at iLIVING USA strive to enrich your life!

II .Guidance for Use

This manual must be read and understood completely before your first use.

If you have difficulty in understanding the warnings, notes and instructions in this owner's manual, or require additional assistance, please contact your authorized provider or distributor to obtain professional guidance and help. Failure to follow the instructions on this manual can lead to your safety being at risk as result of improper usage, and voiding the warranty.

Reference

Authorized Provider: _____

Address: _____

Phone Number: _____

Purchase Date: _____

III .Product Safety Symbols

The following symbols are used to identify warnings, mandatory actions and prohibited actions. It is essential that you fully understand and completely familiarize yourself with these symbols before operating iLiving Power Wheelchair for the first time.



Read and follow the instructions provided in this manual.



Safety warning sign or an indication of a dangerous operation that may endanger your safety or the safety of others.



Class I equipment (Canada) / Class II equipment (USA).



Do not use any mobile phones, walkie talkies, electronic devices or any other radio transmitters while operating.



Finger crush / pinch point.



Store in a clean and dry condition; away from rain, snow, ice, salt and water.



Test of EMI/RFI at an immunity level of 30 V/m has been passed.



Corrosive substance contained in the battery



Danger of explosion



Do not use batteries with different amp-hour (Ah) capacities, No mix use of old and new batteries. Always replace both batteries at the same time.



Keep tools and other metal objects away from battery terminals. If contacted, short-circuit or electric shock may occur and cause injury.



Flammable material, avoid exposure to heat source such as open flame or sparks. Avoid transporting the batteries along with flammable or combustible objects.



Disposal and recycle

IV. Technical Specifications

<i>General</i>	
Dimensions (Unfolded): L x W x H	39.37 x 26x 33.9in / 1000 x 660x 860 mm
Dimensions (Folded): L x W x H	13.38 x 26x 29.5 in / 340 x 660 x 750mm
Suggested User Weight	Max: 255lbs (115kgs)
Weight	58.64lbs (26.6kgs) with battery / 53.13lbs(24.1kg) without battery
Maximum Climbing angle	12 ⁰ (depend on user weight/safe climbing angle)
Full Charge Mileage	Up to 7 mi. (vary with user's weight, terrain, ground condition, battery condition, temperature and driving habit)
Max Speed	3.75 mi./hr or 6 km/h
Turning radius	35 in / 890 mm

<i>Motor</i>	
Type	Brushless DC Motor
Rated power	180 W
Input Voltage	DC 24V
Qty	2 sets
Break System	Intelligent Electromagnetic Brake
Breaking Distance	At max speed: 0.5m

<i>Battery</i>	
Type	Li-ion battery
Nominal Capacity	10 Ah
Output Voltage	DC 24V
Qty	2

<i>Controller</i>	
Type	Brushless dual-drive rocker controller
Input Power	180W x 2
Input Voltage/Current	DC 24V/12A x 2

<i>Front Caster</i>	
Size	7in
Type	Solid Tire
Qty	2

<i>Rear Wheel</i>	
Size	8 in
Type	Solid Tire
Qty	2

V .Features

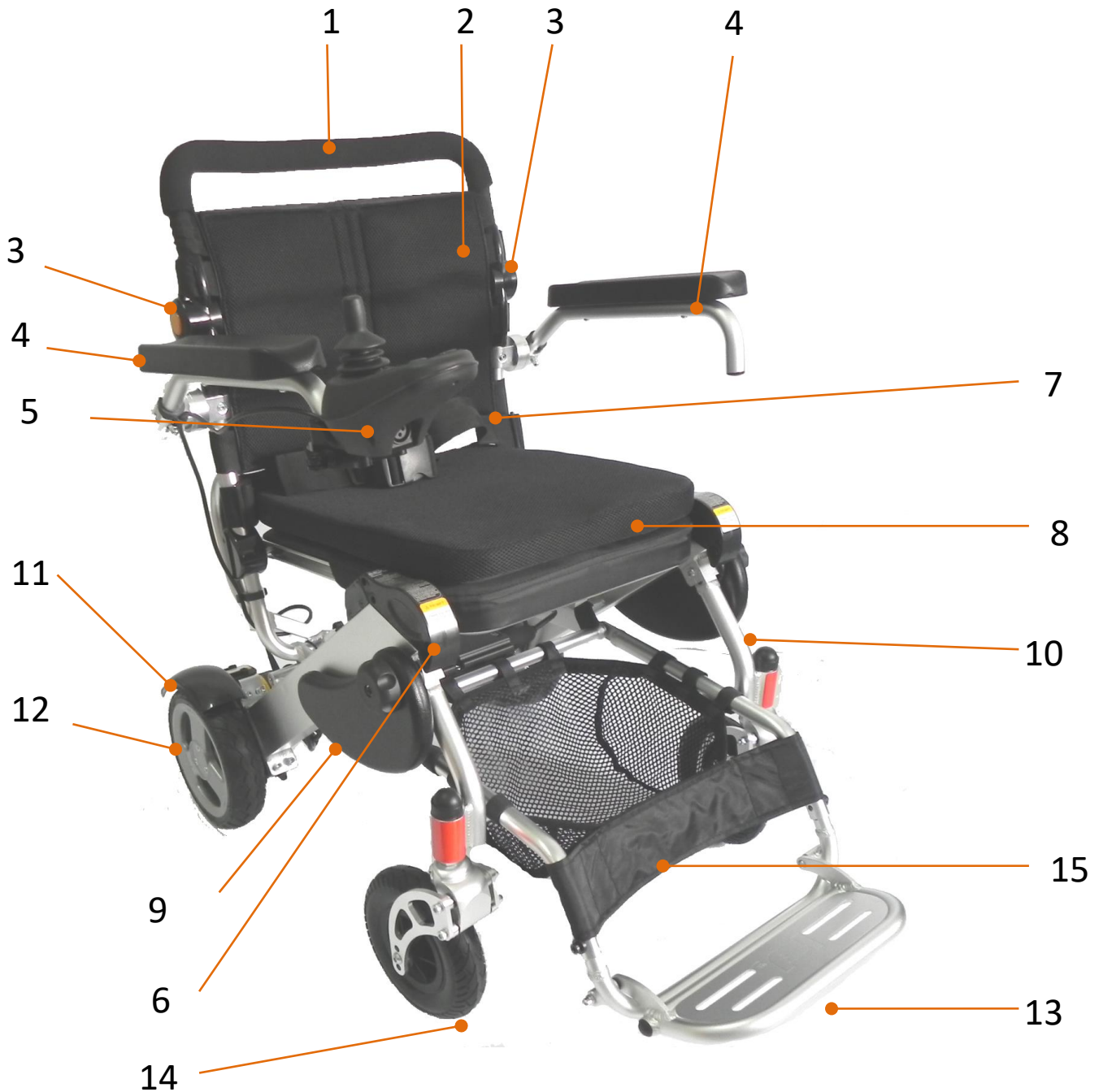

- | | | | |
|-------------------|--------------------|--------------------|-----------------|
| 1. Upper Backrest | 2. Back Cushion | 3. Backrest joint | 4. Armrest |
| 5. Joystick | 6. Lithium Battery | 7. Safety belt | 8. Seat Base |
| 9. Leg Guard | 10. Frame | 11. Splash Guard | 12. Motor Wheel |
| 13. Footrest | 14. Front Wheel | 15. Storage Basket | |

V .Features



16. Folding Release Lever

17. Anti-Tipping Wheels

18. Electromagnetic Brake Levers

19. Control Panel Connector

20. Control Panel Cable Clip

21. Kick Stand

VI. Electromagnetic Interference Warning

The power wheelchair may be affected by electromagnetic interference (EMI), which may cause damage or interruption to the operation of the chair. It is important for you to understand the instructions which can help you take protective measures against the risk of interference.

The sources of electromagnetic waves come from broadcasting stations, TV stations, radio transmitters, two-way radios (such as walkie-talkies), cellular phones and computers. Interference from these electromagnetic waves may cause malfunction or permanent damage to the chair's braking and control system.



1. *The power wheelchair has passed the 30 V/m EMI test and has a certain degree of immunity to most common electromagnetic energy sources. However, it is important for you to follow the safety guidelines as follows:*
 - a. *Do not turn on or operate portable transceivers, receivers, radios or any wireless communication devices.*
 - b. *Stay away from all radio wave emission sources.*
2. *If interference does occur and causes unintended movement to the chair in an uncontrolled manner, cut off the power immediately.*
3. *No modification of any form to the power wheelchair is allowed, including adding or removing any parts.*

VII. Safety



Usage Safety Guidelines

- Check all electrical and control connections to ensure they are secured safely and firmly.
- Check battery levels regularly and ensure the battery is charged immediately when needed.
- Keep tools and any metal objects away from the negative and positive poles of the battery. Short-circuits or electric shock may occur when the two poles are accidentally contacted.
- Familiarize yourself with the Power wheelchair and its capabilities.
- Always seek assistance during your first use until you are confident enough to operate the chair independently and proficiently.
- Always beware of any potential danger while using the power wheelchair.
- When the power wheelchair is not in use, turn off the power, charge the battery and store in a clean and dry place.

Control Panel

To ensure your safety while operating the power wheelchair, the control panel must be securely mounted (Fig. A1). If any buttons on the control panel fail or are not responding, you must stop using the chair immediately and contact the provider for repair or replacement.



A1

VII. Safety

Static Position

When the chair is inactive even for a moment; the power must be off (Fig. A2). This will:

- Prevent the control panel from being activated by accidental touch which may cause the chair to move unintentionally.
- Prevent the chair from electromagnetic interference sources which may activate the chair's operation system and cause damage to the chair and bodily harm.

Do not allow anyone but yourself to touch the control panel. This will protect the chair from being moved without your awareness and causing potential serious bodily harm.



A2

Weather Precautions



This power wheelchair should not be used or stored in environments of rain, snow, icy or slippery surfaces. These conditions may adversely affect the functions of the chair. Always keep your chair in a clean and dry area.

Malfunctions may occur if the device is in contact with rain, snow or high humidity environments. Do not expose the chair to any extremely hot or cold conditions. The chair is not fully waterproof; a humid environment may result in rusting or corrosion inside the chair. If you are ever caught in any of these conditions, please proceed to shelter immediately.

To prevent malfunction, please adhere to the guidelines as follows:

- Do not operate or store the chair in an environment which has direct water contact; extremely hot or cold temperature or high humidity.
- Do not use the chair while showering, swimming, etc.
- Do not use the chair in salt or fresh water
- Do not use the chair around any water sources (e.g. rivers, lakes, etc.)
- Do not flush the chair with water.

VII. Safety

Note: When the chair is wet, immediately pull out the battery and allow it to dry naturally. Put the battery back after the chair is completely dried.

When operating on wet or frictionless ground surfaces, please carefully move at a slow speed and follow the safety guidelines below:

- When any of the motor wheels loses traction, the chair must be stopped immediately to avoid losing control of the chair (e.g. slipping, tipping over, etc.).
- Do not drive into slopes or ramps covered with snow, ice, water, oil, etc.

Road Surfaces

The iLiving Power Wheelchair is designed optimally for dry level surfaces; such as concrete and indoor ground flooring.

Do not use the wheelchair on sand, uneven or loose surfaces, tall grass or rough road surfaces to prevent the wheels, bearings, axis, motor and other parts from being damaged or loosened.

Driving in Traffic Environment

Drive in traffic at your own risk. Beware of the local traffic regulations. Be extremely cautious to your own safety while driving on public roads.

For increased visibility at night, the chair has light reflecting markers attached to the chair (Fig. B1). It is highly recommended that you wear light reflective clothing while driving at night.

- When operating the chair in traffic amongst motor vehicles, it is at your own risk. Keep yourself within the sight of the driver and keep a safe distance. It is not recommended to operate the chair in traffic.



B1

VII. Safety

Vehicle Transport



Please be aware that it is at your own risk and is not advisable to sit in the wheelchair when taking any forms of transportation such as cars, buses, trains, planes or ships.

If you must take such forms of transportation while remaining in the chair, it is extremely important that you secure your positioning waist belt and power off the chair and push the brake lever to “Lock” position, inspect no movement to the motor wheels and have the chair securely tied down. This will help prevent injuries during sudden stops. However, as this chair is ultra-compact, taking any transportation is made possible as you can fold the chair conveniently and can be stored away in tight storage areas such as a car trunk. Please ensure the chair is stored securely in order to avoid injury.

If you need to be transferred on or off a vehicle manually without getting off the chair, never allow anyone to lift the chair by the armrest or rear backrest. The chair must be lifted by firmly gripping the front and rear edges of the seat cushion frame.

Weight Distribution

To avoid tipping over while driving, the balance and stability of the power wheelchair must not be neglected. The following factors may affect the weight distribution of the chair:

- Height and angle of the chair.
- Seating position, or weight loading position of the user’s body.
- The gradient of the ramp or slope.
- Load carried in storage basket or by the user may have adverse effects to the weight distribution of the chair.



Do not modify or adjust wheelchair configuration or construction yourself.

VII. Safety

Getting On/Off

Whenever moving your body, it is recommended to have a supporting point that is higher than the seat cushion. To avoid and reduce the chance of falling, please be aware of the followings:

- Before getting on and off the chair, ensure that you lift up the armrest and lower the leg guard.
- Before getting on the chair, ensure that the power is off and the brake is in “Lock” position. Inspect that there is no movement to the motor wheels.
- Before getting out of the chair, ensure that the power is off and the brake is in “Lock” position. Inspect that there is no movement to the motor wheels. Move the chair as close as possible to the target position to minimize the risk of falling during transfer.
- Consult your health care professionals about the safest way to move your body in and out of the chair.
- Fold up the footrest at all times while getting on and off the chair
 - Do not stand on the footrest to move your body while getting on/off the chair.
 - Make sure your feet are not tangled or jammed in the gap between the footrest while getting on/off the chair.

Leaning or Reaching while Seated

Reaching out your hands or leaning your body in the chair may adversely affect the chair’s balance. If you do not position yourself correctly, you may fall off or tip over the chair.

- When moving your body such as lifting your body at one side or leaving the seat, do not lean your body out of the range of the seat cushion.
- When moving forward on your seat, do not lean your body excessively. Your hip must be always in contact with the seat cushion.
- Do not reach your hands farther than your capability as this may result in falling due to lost balance.
- Under no circumstance should you try to pick up anything through the space between your knees or in front of your body.
- When you extend your body, do not exert force on the footrest to avoid the chair from tipping over, this may result in serious injury.
- Do not rest forcefully against the top of the backrest to avoid tipping over the chair and causing damage to the backrest.



Failing to follow these guidelines may result in serious injury. If you do any of these actions, it is at your own risk.



Never reach, bend, or lean in the chair. Doing so will change your center of gravity and the weight distribution of the chair.

VII. Safety

Stationary Obstacles

Navigating over obstacles such as ramps, slopes, curbs, raised or uneven surfaces, pot holes and rough roads can be hazardous. Extreme caution is needed to avoid tipping the chair over.

It is important to climb or descend an obstacle slowly, cautiously and perpendicularly. Failing to do so may result in damage to the chair or causing bodily harm.



Do not exceed the incline guidelines and specifications in this owner's manual.

To navigate over a stationary obstacle:

- Approach the obstacle slowly, cautiously and perpendicularly.
- With extreme caution, increase the forward speed gently when the front wheels just come in contact with the obstacle and reduce the forward speed gently after the rear wheels cleared the obstacle.
- Lean your upper body slowly and slightly forward, when going over an obstacle with an ascending slope.
- With extreme caution, reduce the forward speed gently when the front wheels just come in contact with the obstacle and increase the forward speed gently after the rear wheels cleared the obstacle.
- Lean your upper body gently against the backrest, when going over an obstacle with a descending slope.
- Avoid any sudden stops and starts.
- Always navigate perpendicularly towards the obstacle.

Inclined Slopes

If you feel uncomfortable driving on a slope, do seek assistance to protect you from causing bodily harm to yourself.

- It is not advisable to drive on slopes over 10°.
- It is prohibited to drive on slopes over 12°.
- It is prohibited to drive on a wet slippery slope (e.g., snow, ice, water, oil).
- It is prohibited to drive on slope if there are pits at the bottom of the slope.
- It is prohibited to drive in areas with continuous up and down slopes

Reverse Driving



When driving in reverse, please exercise extreme caution. The motor wheels may run into an obstructive object which may lead to your chair getting out of control and may cause your chair to tip over.

- All obstructive objects should be cleared and approach cautiously and slowly while driving in reverse
- Never drive in reverse on inclined slopes

VII. Safety

Load Limit

- Max Load of the chair: 253lbs (115kg)
- Do not exceed.
- The safe load of the backrest: 165lbs (74.8kg)

- Do not press down or lift up the backrest.
- Under no circumstances should the user do weight training while using the chair.
- Overloading the chair may cause damage to the chair's frame, fastened parts and folding device.
- Overloading caused damages will void the warranty of the chair.

Getting Up/Down Stairs and Escalators

The wheelchair is not designed for long journeys or getting up and down stairs, and escalators



It is prohibited to move or use wheelchair on stairs and escalators. Serious bodily injury may result.

The Kick Stand Instruction

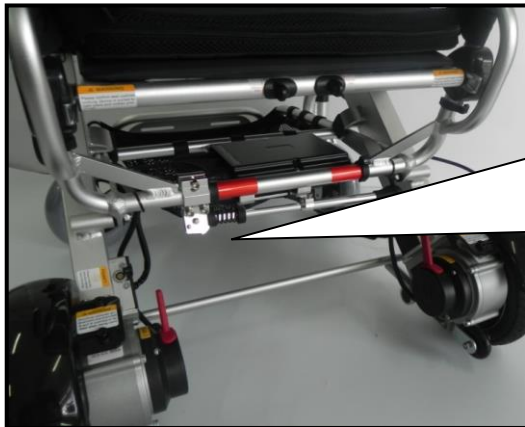

The Kick stand is located at the bottom of the rear frame where red sticker shows .

Notice:

Only after folding wheelchair, the Kick stand can be set upright, Before unfolding the wheelchair , set back kick stand horizontally first .



Only after folding can the kick stand can be set upright! Before unfolding the wheelchair, set back the kick stand horizontally first. Please don't adjust kick stand length .

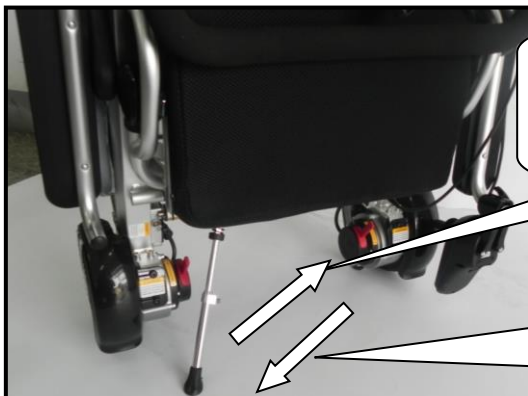

Set back the kick stand in the direction shown by arrow

Open the kick stand in the direction shown by the arrow



VIII. Installation Guide

Positioning Waist Belt

The positioning waist belt is for holding your hip properly against the back of the seat and must be strapped 45° over your hip (Fig. C) to prevent the user from falling off the chair. Please wear the waist belt at all times while seated.



Please be aware that the waist belt is not intended for use as an auto style seat belt. The wheelchair is not designed for being used as a seat in any forms of transportation.

You must wear the seat belt provided in all forms of transportation.

It is not recommended to use the chair as a seat when taking any forms of transportation such as cars, buses, trains, planes or ships.

CAUTION

- 1. Always ensure the waist belt is appropriately installed onto the chair and adjusted securely so that it is snug, but also comfortable enough so that it does not interfere with your breathing.*
- 2. Always check the waist belt for any loose parts or wear and tear. If any problem is found, contact your provider for maintenance or repair.*



C

VIII. Installation Guide

Mounting the Control Panel

The control panel can be mounted on the right or left armrest. As shown in Fig. D1, put the quick release clamp of the control panel onto the metal grab bar and lock the quick release handle tightly and securely.

1. As shown in Fig. D2, route the control panel cable through the cable clip



D1



D2

2. As shown in Fig. D3, plug the four – pin control plug of the control panel into the socket at either side.



D3

3. As shown in Fig. D4, there is connector for the control panel on the left and right side of the chair. Please keep the dust cap of the unoccupied connector firmly closed at all times.



D4

IX. Operation Guide

Control Panels





The Control Panel comprises of the following:

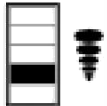

Number:	Function:	Description:
1	Power-On Button	Pressing this button will power on the chair.
2	Power-Off Button	Pressing this button will power off the chair.
3	Speed Button	Increase the speed of the chair Max. speed: 6 km/hr (3.75 m/hr).
4	Speed Button	Decrease the speed of the chair.
5	Horn	Press horn to sound.
6	Battery Life Indicator	Indicate the battery level.
7	Control Joystick	Control the direction and speed of the chair. Push the joystick towards the desired direction.
8	Speed Indicator	With 5 LED lights on, the chair at its max. speed. 1 LED light on, the chair is at its lowest speed.

IX. Operation Guide

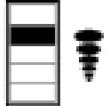
When the LED light flashes intermittently, refer to the diagnostic troubles in the table below:

	The lowest LED light flashes: Batteries are running low
	The second LED light flashes: Joystick cannot deliver signals to the control module
	The third LED light flashes: Batteries are being charged. Note: An electronic drive locking device is engaged to prevent the chair from operating.
	The fourth LED light flashes: Motor connection failed
	The fifth LED light flashes: Electromagnetic braking disengaged

Control Joystick

When operating the chair for the first time, it is recommended to move the chair at a low speed gently and gradually pushing the control joystick forward. The practice run will help you familiarize yourself with controlling the speed and start and stop of the chair.

Do not do sharp turns at high speeds. The chair will lose its balance and tip over causing serious bodily injury and property damage.

The control joystick on the control panel provides 360 degrees of omni-bearing maneuverability comfortably and effortlessly. A spring is equipped inside the joystick which automatically returns to its original position when let go.

Push the joystick towards the target direction. The joystick can control the drive proportionally, the harder the push, the faster it goes. The max traveling speed is 6km/hr.

Release the control joystick slowly and gradually for the chair to slow down safely. Sudden release of the control joystick may cause the chair to lose balance and tip over causing bodily injury.

IX. Operation Guide

Movement	Control lever operation
Forward	Push the control lever forward
Backward	Pull the control lever backward
Right	Push the control lever to the right
Left	Push the control lever to the left
Stop	Release the control lever gradually (the chair will slow down to stop safely)

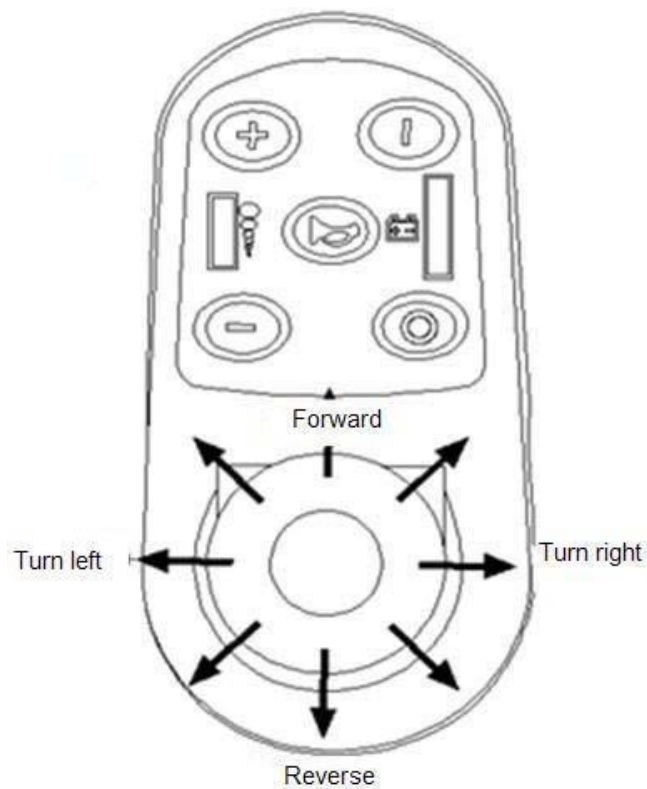

X. Braking



After any adjustment, repair or maintenance, check all components and parts for tightness before use, otherwise damage or injury may occur.



Electromagnetic Brake System

The chair has 2 braking modes which can be selected by pushing the brake levers to “Lock” or “Unlock” position.

- In “Lock” position: the internal clutch of the electromagnetic brake is engaged and the electromagnetic brake is started. Before powering on and attempting to operate the control joystick, the motor wheels will not move. Having the brake in the “Lock” position will ensure the chair does not move, allowing the user to get on/off the chair safely and securely.
- In “Unlock” position: the internal clutch of the electromagnetic brake is disengaged. In “Unlock” position, the motor wheels can move freely even when the chair is powered off. This will allow the chair to move manually.



Before using the chair, it is important that the brake lever is in the “LOCK” position and the electromagnetic brake is engaged to stop the rotation of the motor wheels. This will prevent any accidents from occurring and causing bodily injury.

1. *Do not operate the chair while the brake is in “Unlock” position, without the presence of an attendant.*
2. *Do not seat yourself in the chair while the brake is in “Unlock” position, without any assistance from an attendant.*
3. *Do not place the chair on an incline or decline while the brake is in “Unlock” position, the chair may roll out of control and may cause damage to the chair or bodily harm.*

XI. Battery



Do not use batteries with different amp-hour (Ah) capacities. Do not mix use of old and new batteries. Always replace both batteries at the same time.



Keep tools and other metal objects away from battery terminals. If contacted, short-circuit or electric shock may occur and cause injury.



Avoid flammable materials. Avoid exposure to heat sources such as open flames or sparks. Do not transport the batteries along with flammable or combustible objects.



Corrosive substance contained in the battery. Do not disassemble the battery.



Danger of explosion. When charging the batteries, place the chair and the battery charger in a well ventilated area, away from flames and sparks.



Warning

- *Do not attempt to connect the battery terminal directly using pliers or metal cables to charge the battery.*
- *Do not use the chair when the battery is being charged. An electronic drive locking device will be activated that prevents the chair from operating when the battery is being charged.*
- *Do not use a non-standard power supply (eg. generator or inverter).*
- *Do not squeeze, bend, jerk or tie the power cord.*
- *Do not smoke or ignite anything around the battery.*
- *When pulling the power cord, grab the plug to pull it out.*
- *Keep the power cord away from children or pets.*
- *If there is any issue with the circuit breaker, pull out the charger immediately and contact your provider.*
- *The operating temperature of the battery is -5°C (23°F) to 40°C (104°F).*

XI. Battery

Battery Maintenance

The battery's life and performance may be affected by temperature, condition of the battery, and the weight of the user. Charging the battery continuously for a long duration before the first use can reduce the battery's service life. It is recommended that you charge the battery for the first time, when the lowest level of the LED light on the control panel flashes.

When charging a new battery for the first time, it must be fully charged (about 24 hours) in order to fully activate the battery.

Always check if the battery is fully charged before use. The regular charging time is about 5 hours. But if the battery is fully drained it may take 10-12 hours to charge fully until the red LED on the charger turns green. Thus the recommended charging time for the battery is 8-12 hrs.

When not using the chair for a long duration, charge the battery fully every 2 months. If the battery is left uncharged for a long period of time, it will damage the battery permanently.

Mounting/Removing Battery

Ensure the chair is powered off before mounting or removing the battery.

Taking out the battery:

1. Near the edge of the seat base, the batteries are located at the sides of the chair.
2. Press the button (Fig. E1), hold the battery grip and pull the battery out of the battery holder (Fig. E2)



E1



E2

XI. Battery

Mounting the battery:

1. Hold the battery grip and plug in the battery with the battery bottom aligned to the mouth of the battery holder (Fig. E3). When a click sound is heard, the battery has been mounted firmly.



E3

Charging the Battery

The battery can be charged with normal AC power (AC 110-220 V, 50-60 Hz). The charging port is located under the front part of the control panel. Before charging, ensure the chair is powered off.

1. Plug the off-board charger 3 – pin cable into the charging port under the front part of the control panel (Fig. E4)
2. Plug the off-board charger into a power outlet. When the red LED is on, it is charging.
3. When the LED on the charger changes from red to green, keep charging for an additional 30 minutes to allow the battery to be fully charged.
4. Unplug the off-board charger from the power outlet before unplugging from the charging port of the control panel.
5. Please charge the battery in an appropriate temperature. The recommended ambient temperature for charging is between 5° C to 40° C.



E4

Over-discharge Protector

The lithium battery will be permanently damaged if the battery's capacity has been completely discharged. Therefore, the iLiving Power Wheelchair is equipped with an over-discharge protector. When the lithium battery is running out, the protector will cut off the circuit automatically and the controller will stop working.

When the lowest level red LED light on the battery level indicator flashes, it means that the batteries need to be charged.

When there is no red LED light on battery level indicator, it means that the batteries must be charged within 2 hours immediately. If not, the battery may not be activated permanently.

The charging time after over-discharge takes 10-12 hours.

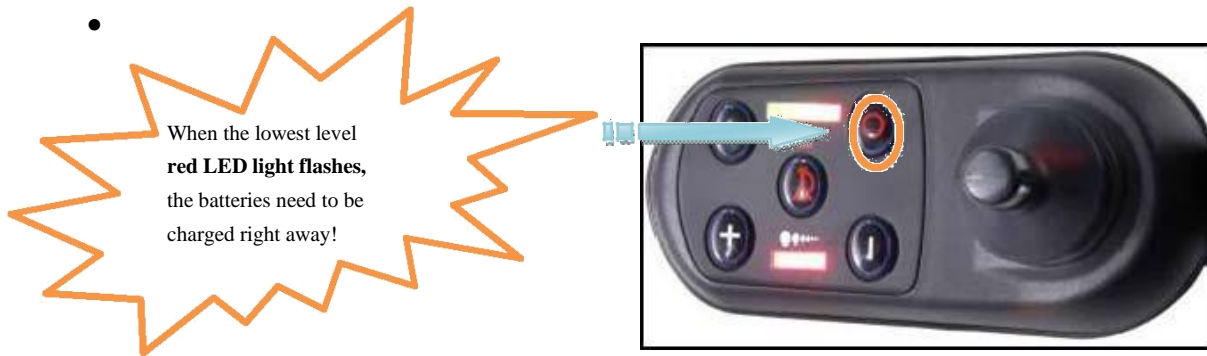

Over-current Protector

The wheelchair is also equipped with an over-current protector. If the current supplied to the motor is too high, the over-current protector will cut off the current supply. If crossing over a slope over 12° or the load is over 255 lbs or the motor rotation is jammed, the over-current protector will be activated and the chair's control will cut off the circuit to prevent overcurrent and overheating of the motor. The red LED light on the control panel will flash and the buzzer will sound.

Battery Socket Cleaning

- Check the battery pack and the positive and negative poles for any corrosion. If there is any corrosion, clean with battery cleaning tools, steel brush or medium sand paper.
- When cleaning, Keep tools and other metal objects away from battery terminals. If contacted, short-circuit or electric shock may occur and cause bodily injury.



Do not allow the acidic substance inside the battery to come into contact with your skin, clothes or other items. The substance is extremely hazardous and may cause serious burns. When contacted, immediately flush your skin with cold water and seek medical attention.

XII. Unfolding and Folding

After any adjustments, repairs or maintenance, ensure all components are securely tightened.



When lifting the chair, it is strongly recommended to get the user off the chair before lifting or handling the chair. If it is absolutely necessary to handle the chair and yourself together, please exercise extreme caution and have at least two attendants to assist in lifting the chair. The front and rear edges of the seat base and frame should be held.

Unfolding



F1

1. As shown in Fig. F1, pull out the chair by holding the position shown in the figure as directed by the arrows.



F2

2. Unfold the footrest as directed by the arrow in Fig. F2



F3

3. Rotate the two armrests into position as directed by the arrow in Fig. F3.



F4

4. Pull the backrest to the rear edge of the seat cushion until the two folding levers reach the red line (Fig. F4). When a click sound is heard, the chair is unfolded.

XII. Unfolding and Folding



F5

5. As shown in Fig. F5, press the backrest adjusting button and turn the back rest in the direction shown in the figure until a click sound is heard.

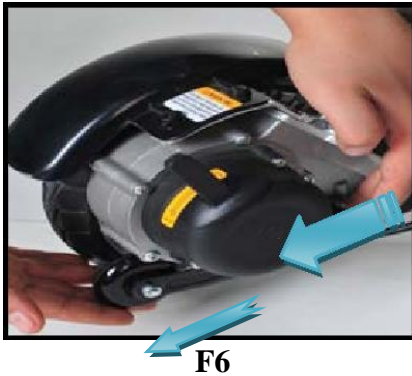

F6

6. As shown in Fig. F6, press the anti-tipping wheel button and pull out the anti-tipping wheel.



F7

7. Mount the control panel and plug in the 4 –pin control cable in accordance with Fig. F7. (refer to the instructions on mounting the Control Panel)



F8

8. Fully expanded power wheelchair. Fig. F8

Folding

1. Remove the control panel. (Fig. F9)

**F9**

2. Press the anti-tipping wheel button and retract the anti-tipping wheel. (Fig. F10)

**F10**

3. Press the backrest adjusting button (Fig. F11) and turn the back rest in the direction as shown in Fig. F12.

**F11****F12**

4. Rotate the armrest as shown in Fig. F13.

**F13**

5. Loosen the knob as shown in Fig. F14 and turn the leg guard down.

**F14**

6. Hold the folding lever (Fig. F15) and push the backrest forward (Fig. F16).

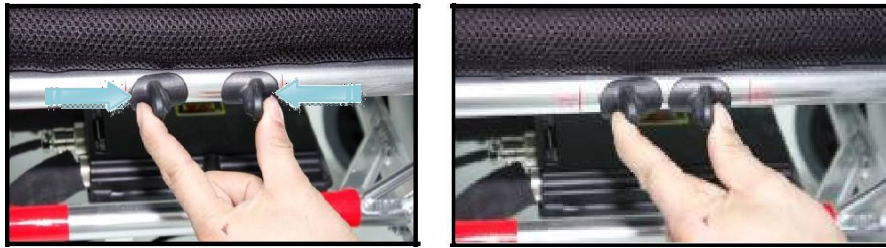

F15

7. Press the chair tightly as shown in Fig. F16 until it is fully closed as shown in Fig. F17.

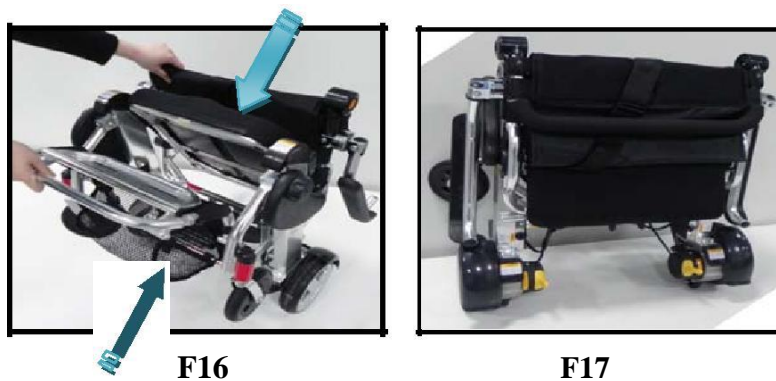

F16

F17

Anti-Tipping Wheel



G1

1. As shown in Fig. G1, press the anti-tipping wheel button. Pull out the anti-tipping wheel to the position of the hole for it to lock.
2. As shown in Fig. G1, press the anti-tipping wheel button to retract the anti-tipping wheel.

XIII. Troubleshooting

The control panel will display a number of possible trouble conditions by means of the LED light. When the LED light is green, the chair is trouble-free. When a problem occurs, the LED light will flash.

When a “Trouble” LED light flashes, turn off the power of the chair and turn it on again. If the flashing “Trouble” LED light remains unchanged, please refer to the table below for possible causes and solutions.

If you cannot determine the cause of the trouble condition, please contact your provider or distributor for assistance.

Troubleshooting Table

No	Trouble	Possible cause	Solution
1	Power	Faulty connection of the control panel and the motor connector.	Re-plug the 4 – pin plug into the battery connector at the side of the chair; refer to instructions on Page 16.
		Low power supply, the power cut off automatically.	If the power is off automatically, the batteries must be recharged within 2 hrs, and charged for 10-12 hrs, refer to instructions on Page 23 and 24
		Fault of the 3 – pin plug connecting to the battery.	Pull out the battery and check the contact for any fault and re-insert the battery. Refer to instructions on Page 22 and 23.
2	LED light flashes	The lowest level LED light flashes: low battery power.	Recharge the batteries immediately.
		The second level LED light flashes: the control panel failing to deliver control signal	Reconnect the plugs of the two ends of the control panel cable, or replace the control panel.
		The third level LED light flashes: the batteries are being charged	Do not use the chair, An electronic drive locking device prevents the chair from operating when batteries are being charged.
		The fourth level LED light flashes: motor connection failed.	Re-plug and tighten the motor connector

XIII. Troubleshooting

		The fifth level LED light flashes: The electromagnetic brake is in “Unlock” Position and the chair will not move	Push the electromagnetic brake lever to “Lock” position, please refer to instructions on Page 20
3	Electromagnetic brake	When the power is off, and the electromagnetic brake lever is in “Lock” position, the motor wheels can move freely.	Contact the customer service to replace the electromagnetic brake.
		When the power is on, and the electromagnetic brake lever is in “Lock” position, the motor wheels cannot move.	Contact the customer service to replace the electromagnetic brake.
		When the power is off, and the electromagnetic brake lever is in “Unlock” position, the motor wheels cannot move.	Contact the customer service to replace the electromagnetic brake.
4	Motor Wheels	Noise and vibration occurs in the course of motor running.	Contact the customer service
5	Distance per charge decreased	Low temperature environment below 0	It is normal as this is the characteristics of <u>lithium</u> batteries.
		Battery use has exceeded its service life.	Contact customer service to replace the battery.
6	Charging	Faulty connection of the control panel and the battery connector	Reconnect the 4 – pin plug into the battery connector at the side of the chair.
		Control Panel damage.	Contact customer service to replace controller.
		Charger plug damaged.	Contact customer service to replace charger.
		Charging plug loosened.	Reconnect firmly.
7	Fail to start when power on	After not using for a period or after charging.	Turn the power on and off. To reactivate

XIV.Warranty

Warranty included items	Time Frame (From date of purchase)	Description
Main Frame	3 years	Incorrect use, damaged by the user or modifications to the chair, will void the warranty and repair costs will be charged.
Motor	1 years for the motor	Damaged due to overload or tampering by the user will void the warranty.
Battery	1 year for the lithium battery	Damaged due to incorrect charging or tampering by the user will void the warranty. We are not responsible for accident caused thereof after.
Joystick Controller	1 year	Damaged due to incorrect use, modification by the user will void the warranty. Repair costs will be charged.
Control Panel		

Invoice and warranty card are required for service within the warranty period, otherwise all repair costs will be charged. iLIVING USA will repair or replace at our option to the original purchaser, free of charge, any of the warranty included items being examined by an authorized representative of iLIVING USA and found defective in material and/or workmanship. For repair beyond the warranty period, material costs will be charged, whereas the purchaser shall undertake the costs of transport.

XIV.Warranty

Warranty Exclusions

1. The warranty exclusions extend to the following items:
 - a. Upholstery and seating, armrest, leg guard, footrest, brake pads, motor brushes, tires require replacement due to normal wear and tear.
 - b. Damaged components due to negligence, accident, misuse, abuse, overload commercial use, improper operation, maintenance or storage.
 - c. Circumstances beyond the control of iLIVING USA.
 - d. Modifications and / or repairs made to the chair without consent in writing from iLIVING USA.
2. If the serial number on the chair is not original or is modified, or is inconsistent with that on the warranty card, or the serial number on the warranty card is altered, warranty will be voided.
3. The warranty is non-transferable and is for the original purchaser of the chair only.

As a manufacturer, our responsibility is to repair or replace damaged parts.

To the extent permitted by law, this warranty instruction supersedes any other warranties; such as writing, oral, expressive or implicit warranties, including warranties of any merchantability or applicability of special purpose, for any conflicts between the same, this warranty instruction shall prevail.

Disclaimer

Thank you for purchasing the iLiving Power Wheelchair. iLIVING USA disclaims all responsibility for any personal injury or property damage as a result of improper or unsafe use of this chair.

If you have any questions about wheelchair and its safe operation, please feel free to contact your authorized provider.

XV.Packing List

Name	Qty	Remark
Main wheelchair frame	1	/
Lithium battery	2	/
Joystick control panel	1	/
Charger	1	/
Instruction manual	1	/
Video tutorial	1	/
Storage basket	1	/
Certificate of inspection/warranty card	1	/



iLIVING USA
860 Mahler Road
Burlingame, CA 94010

Phone: 1-800-317-1688
Email: sales@ilivingusa.com
www.ilivingusa.com