



VFD500M Series

High performance smart Inverter

User Manual



ShenZhen VEIKONG Electric CO., Ltd.

Factory Address:
Block E01,first industrial park lingbei 5 road ,phoenix comm
unity,fuyong street , Bao'anDistrict, Shenzhen ,China

R&D Center: Jin yu cheng building A,Bu Long Rd Bantian Town
,Longgang district Shenzhen City,China
Technical Support Hotline: +86-0755-89587650
Web Site: www.veikong-electric.com
Whatsapp +8615989436541



Preface

Thank you for purchasing the VFD500M series high performance vector and torque control frequency inverter

VFD500M is a economical vector control inverter for asynchronous motor control .High reliability, easy to use, compact size and rich functions; support open-loop VF control and speed sensorless vector control, can be used for driving various automatic production equipment

This manual introduces functional characteristics and usage of VFD500M series inverter, includes product model selection, parameter settings, running and debugging, maintenance, checking, and so on. Please be sure to read this manual carefully before operation. For equipment matching manufacturers, please send this manual to your end user together with your devices, in order to facilitate the usage.

PRECAUTIONS

- ◆ To describe the product details, the illustrations in the manual sometimes are under the state of removing the outer housing or security covering. While using the product, please be sure to mount the housing or covering as required, and operate in accordance with the contents of manual.
- ◆ The illustrations in this manual is only for explanation, may be different from the products you ordered.
- ◆ Committed to constantly improving the products and features will continue to upgrade, the information provided is subject to change without notice.
- ◆ Please contact with the regional agent or client service center directly of factory if there is any questions during usage.

EDIT: V1.1

TIME: 2020-10

Contents

Chapter 1 Safety Information and Precautions	1
1.1 Safety Precautions	1
1.2 Precaution	2
Chapter 2 Product Information	4
2.1 Designation Rules	4
2.2 Product series instruction	4
2.3 Technical Specifications	5
Chapter 3 Product appearance and Installation Dimension	8
3.1 Product appearance and installation	8
3.1.1 Product appearance	8
3.1.2 Appearance and Mounting Hole Dimension	8
3.2 Wiring	9
3.2.1 Standard wiring diagram	9
3.2.2 Main Circuit Terminals	10
3.2.3 Terminal screws and wiring specifications	11
3.2.4 Cautions for Main Circuit Wiring	11
3.2.5 Control Circuit Terminal	12
4.1 LED Instruction of operation and display	16
4.2 Digital tube display	17
Chapter 5 Function Code Table	19
Chapter 6 Fault Diagnosis and Solution	84
6.2 Warning type	90
Chapter 7 Daily maintenance of frequency inverters	91
8.1 Daily maintenance	91
8.1.1 Daily maintenance	91
8.1.2 Regular inspection	91
8.2 Wearing parts replacement	91
8.3 Warranty Items	92
Appendix A Modbus communication protocol	93

Chapter 1 Safety Information and Precautions

Safety Definitions: In this manual, safety precautions are divided into the following two categories:



indicates that failure to comply with the notice will result in serious injury or even death









indicates that failure to comply with the notice will result in moderate or minor injury and equipment damage

Read this manual carefully so that you have a thorough understanding. Installation, commissioning or maintenance may be performed in conjunction with this chapter. will assume no liability or responsibility for any injury or loss caused by improper operation.

1.1 Safety Precautions

Use stage	Security Level	Precautions
Before Installation	 DANGER	<ul style="list-style-type: none"> ➤ packing water, parts missing or damaged parts, please do not install! ➤ Packaging logo and physical name does not match, please do not install!
	 WARNING	<ul style="list-style-type: none"> ➤ Handling should be light lift, otherwise there is the danger of damage to equipment! ➤ Do not use damaged drive or missing drive. Risk of injury! ➤ Do not touch the control system components by hand, or there is the danger of electrostatic damage!
During Installation	 DANGER	<ul style="list-style-type: none"> ➤ Please install the flame retardant objects such as metal, away from combustibles, or may cause a fire!
	 WARNING	<ul style="list-style-type: none"> ➤ Do not allow lead wires or screws to fall into the drive, otherwise the drive may be damaged! ➤ Install the drive in a place where there is less vibration and direct sunlight. ➤ Drive placed in airtight cabinet or confined space, please note the installation of space to ensure the cooling effect.
Wiring	 DANGER	<ul style="list-style-type: none"> ➤ You must follow the guidance of this manual and be used by qualified electrical engineers. Otherwise, unexpected danger may occur! ➤ There must be a circuit breaker between the drive and the power supply, otherwise a fire may occur! ➤ Make sure the power supply is in zero-energy state before wiring, otherwise there is danger of electric shock! ➤ Please follow the standard to the drive properly grounded, otherwise there is the risk of electric shock!
	 WARNING	<ul style="list-style-type: none"> ➤ Never connect input power to the drive's output terminals (U, V, W). Note that the terminal markings, do not take the wrong line! Otherwise it will cause damage to the drive! ➤ Never connect the braking resistor directly to the DC bus +, - terminals. Otherwise it will cause a fire! ➤ Refer to the manual's recommendations for the wire diameter used. Otherwise it may happen accident! ➤ Do not disassemble the connecting cable inside the driver. Otherwise, the internal of the servo driver may be damaged.
Before Power-on	 DANGER	<ul style="list-style-type: none"> ➤ Make sure the voltage level of the input power is the same as the rated voltage of the driver. Check if the wiring position of the power input terminals (R, S, T) and output terminals (U, V, W) is correct; Of

Use stage	Security Level	Precautions
		<p>the external circuit is short-circuited, the connection is tightened, or cause damage to the drive!</p> <ul style="list-style-type: none"> ➤ No part of the drive need to withstand voltage test, the product has been made before the test. Otherwise it may cause accident!
	 WARNING	<ul style="list-style-type: none"> ➤ The driver must be covered before the cover can be powered, otherwise it may cause electric shock! ➤ All peripheral accessories must be wired according to the instructions in this manual, and be properly wired in accordance with this manual. Otherwise it may cause accident!
After Power-on	 DANGER	<ul style="list-style-type: none"> ➤ Do not open the cover after power on, otherwise there is danger of electric shock! ➤ If the indicator light does not light after power on, the keyboard does not display the situation, immediately disconnect the power switch, do not touch any input and output terminals of the drive, otherwise there is the risk of electric shock!
	 WARNING	<ul style="list-style-type: none"> ➤ If parameter identification is required, preclude the possibility of injury when rotating the motor! ➤ Do not arbitrarily change the drive manufacturer parameters, or it may cause damage to the device!
During Operation	 DANGER	<ul style="list-style-type: none"> ➤ Do not touch the cooling fan, radiator and discharge resistance to test the temperature, otherwise it may cause burns! ➤ Non-professional technicians Do not detect the signal during operation, otherwise it may cause personal injury or equipment damage!
	 WARNING	<ul style="list-style-type: none"> ➤ Drive operation, should avoid something falling into the device, otherwise it will cause damage to the device! ➤ Do not use the contactor on-off method to control the start and stop the drive, otherwise it will cause damage to the equipment!
Maintenance	 DANGER	<ul style="list-style-type: none"> ➤ Do not live on the equipment repair and maintenance, or there is a risk of electric shock! ➤ Turn off the input power for 10 minutes before performing maintenance and repair on the drive, otherwise the residual charge on the capacitor will cause harm to people! ➤ Do not carry out maintenance and repair on the drive without personnel who have been professionally trained, otherwise personal injury or equipment damage will occur! ➤ All pluggable plug-ins must be unplugged in the case of power failure! ➤ The parameters must be set and checked after replacing the drive.
	 WARNING	<ul style="list-style-type: none"> ➤ Before performing maintenance work on the drive, make sure that the motor is disconnected from the drive to prevent the motor from feeding back power to the drive due to accidental rotation.

1.2 Precaution

● Contactor using

If the contactor is installed on the power input side of the inverter, do not make the contactor frequent on-off operation. The interval between ON and OFF of the contactor should not be less than one hour. Frequent charging and discharging will reduce the use of capacitors in the inverter life.

If a contactor is installed between the inverter output terminals (U, V, W) and the motor, make sure that the inverter is turned on and off when there is no output. Otherwise, the inverter may be damaged.

● Lightning impulse protection

Although this series of inverters are equipped with lightning over-current protection device, there is a certain degree of self-protection for inductive lightning, but for lightning frequent place, customers should also install lightning protection device in the front of the inverter.

- **Altitude and derating use**

In areas above 1000m above sea level, it is necessary to derate the inverter due to poor air quality due to poor air quality. In this case, please consult our company.

- **Power input**

The inverter power input should not exceed the operating voltage range specified in this manual. If necessary, use a step-up or step-down device to change the power supply to the specified voltage range.

Do not change the three-phase inverter to two-phase input, otherwise it will cause malfunction or inverter damage.

- **Output filtering**

When the cable length between the inverter and the motor exceeds 100 meters, it is suggested to use the output AC reactor to avoid inverter over-current caused by excessive distributed capacitance. Output filter according to the needs of the field matching.

Inverter output is PWM wave, please do not install the capacitor on the output side to improve the power factor or lightning varistor, etc., otherwise it may easily lead to inverter instantaneous overcurrent or even damage the inverter.

- **About motor heat and noise**

Because the inverter output voltage is PWM wave, contains a certain degree of harmonics, so the motor temperature rise, noise and vibration compared with the same frequency operation will be slightly increased.

- **Disposal**

Electrolytic capacitors on the main circuit and electrolytic capacitors on the printed circuit board may explode when incinerated, and poisonous gases are generated when plastic parts are burned. Please dispose as industrial waste.

- **The scope of application**

This product is not designed and manufactured for use on equipment where life is at stake. To use this product on a mobile, medical, aerospace, nuclear or other special purpose device, please contact our company For more information.

This product is manufactured under strict quality control and should be equipped with a safety device if it is used in a device that may cause a serious accident or damage due to inverter failure.

Chapter 2 Product Information

2.1 Designation Rules

Name plate:

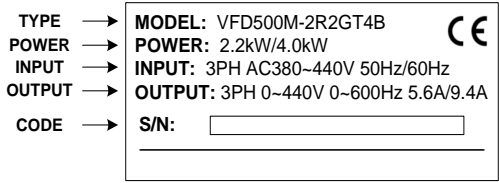

2-1 name plate

Model instruction:

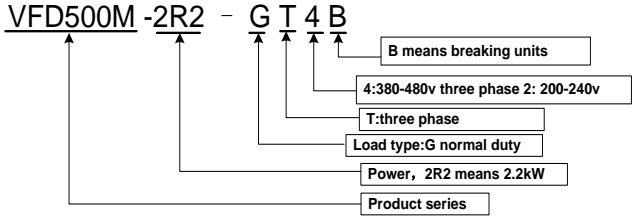

2-2model instruction

2.2Product series instruction

Table 2-1VFD500M inverter models and technical data

Model	Power capacity (KVA)	Input current (A)	Output current(A)		Adapt able Motor (KW)	SIZE	Brake Unit
			Heavy load	Light load			
3 phase: 380V-480V, 50/60Hz							
VFD500M-R75GT4B	1.6	3.2	2.5	4.2	0.75	SIZE B	Internal
VFD500M-1R5GT4B	2.8	4.7	4.2	5.6	1.5		
VFD500M-2R2GT4B	3.7	7.8	5.6	9.4	2.2		
VFD500M-4R0GT4B	6.2	11.6	9.4	10.5	3.7		
VFD500M-5R5GT4B	8.6	15.6	13.0	17.0	5.5	SIZE C	Internal
VFD500M-7R5GT4B	11.2	20.5	17.0	23.0	7.5		
1 phase: 200-240V, 50/60Hz							
VFD500M-R40GS2B	1.2	6.9	2.8	3.2	0.4	SIZEA	Internal
VFD500M-R75GS2B	2.1	12.2	4.5	4.8	0.75		
VFD500M-1R5GS2B	3.1	17.0	8.0	10.6	1.5	SIZEB	
VFD500M-2R2GS2B	4.1	21.0	10.6	12.5	2.2		
3 phase: 200V-240V, 50/60Hz							
VFD500M-R40GT2B	1.2	4	2.8	3.2	0.4	Size B	Internal
VFD500M-R75GT2B	2.1	7.1	4.5	4.8	0.75		
VFD500M-1R5GT2B	3.1	11.3	8.0	10.6	1.5		
VFD500M-2R2GT2B	4.1	14.5	10.6	12.5	2.2		

2.3 Technical Specifications

Table 2-2 VFD500M Technical Specifications

Item		Specification
Input	Input Voltage	1phase/3phase 220V: 200V~240V 3 phase 380V-480V: 380V~480V
	Allowed Voltage fluctuation range	-15%~10%
	Input frequency	50Hz / 60Hz, fluctuation less than 5%
Output	Output Voltage	1/3phase: 0~input voltage
	Overload capacity	General purpose application: 60S for 150% of the rated current Light load application: 60S for 120% of the rated current
Control	Control mode	V/f control Sensorless flux vector control without PG card (SVC)
	Operating mode	Speed control、Torque control (SVC)
	Speed range	1:100 (V/f) 1:200(SVC)
	Speed control accuracy	±0.5% (V/f) ±0.2% (SVC)

	Speed response	5Hz(V/f) 20Hz(SVC)
	frequency range	0.00~600.00Hz(V/f) 0.00~200.00Hz(SVC)
	Input frequency resolution	Digital setting: 0.01 Hz Analog setting: maximum frequency x 0.1%
	Startup torque	150%/0.5Hz(V/f) 180%/0.25Hz(SVC)
	Torque control accuracy	SVC: within 5Hz10%, above 5Hz5% VC:3.0%
	V/f curve	V / f curve type: straight line, multipoint, power function, V / f separation; Torque boost support: Automatic torque boost (factory setting), manual torque boost
	Frequency giving ramp	Support linear and S curve acceleration and deceleration; 4 groups of acceleration and deceleration time, setting range 0.00s ~ 60000s
	DC bus voltage control	Overvoltage stall control: limit the power generation of the motor by adjusting the output frequency to avoid skipping the voltage fault; Undervoltage stall control: control the power consumption of the motor by adjusting the output frequency to avoid yaw failure VdcMax Control: Limit the amount of power generated by the motor by adjusting the output frequency to avoid over-voltage trip; VdcMin control: Control the power consumption of the motor by adjusting the output frequency, to avoid jump undervoltage fault
	Carrier frequency	1kHz~16kHz(Varies depending on the type)
	Startup method	Direct start (can be superimposed DC brake); speed tracking start
	Stop method	Deceleration stop (can be superimposed DC braking); free to stop
	Maincontrol function	Jog control, droop control, up to 16-speed operation, dangerous speed avoidance, swing frequency operation, acceleration and deceleration time switching, VF separation, over excitation braking, process PID control, sleep and wake-up function, built-in simple PLC logic, virtual Input and output terminals, built-in delay unit, built-in comparison unit and logic unit, parameter backup and recovery, perfect fault record,fault reset, two groups of motor parametersfreeswitching, software swap output wiring, terminals UP / DOWN
Function	Keypad	LED Digital keypad and LCD keypad(option)and external LED display
	communication	Standard: MODBUS communication
	Input terminal	Size A:4 digital input terminals and 1 analog input terminals Size B:5 digital input terminals,one of which supports high-speed pulse input up to 50kHz;2 analog input terminalssupport 0 ~ 10V voltage input or 0 ~ 20mA current input;
	Output terminal	Size A 1 digital output terminal; 1 relay output terminal(Support NO only) 1 analog output terminals, support 0 ~ 20mA current output or 0 ~ 10V voltage output; Size B 1 digital output terminal; 1 high-speed pulse output terminal (open collector type), support 0 ~ 50kHz square wave signal output; 1 relay output terminal(SUPPORT NO AND NC) 1 analog output terminals, support 0 ~ 20mA current output or 0 ~ 10V voltage output;
Protection	Refer to Chapter 6 "Troubleshooting and Countermeasures" for the protection function	
Environment	Installation location	Indoor, no direct sunlight, dust, corrosive gas, combustible gas, oil

		smoke, vapor, drip or salt.
	Altitude	0-3000m.inverter will be derated if altitude higher than1000m and rated output current will reduce by 1% if altitude increase by 100m
	Ambient temperature	-10°C~ +40°C,maximum 50°C (derated if the ambient temperature is between 40°C and 50°C)Rated output current decrease by 1.5% if temperature increase by 1°C
	Humidity	Less than 95%RH, without condensing
	Vibration	Less than 5.9 m/s ² (0.6 g)
	Storage temperature	-20°C ~ +60°C
Others	Installation	Wall-mounted, floor-controlled cabinet, transmural
	Protection level	IP20
	cooling method	Forced air cooling FOR SIZE B ,SIZE A(NATURAL COOLING)

Chapter 3 Product appearance and Installation Dimension

3.1 Product appearance and installation

3.1.1 Product appearance

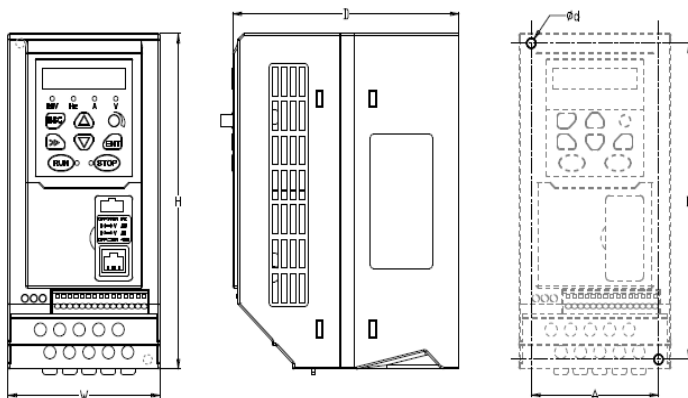

3.1.2 Appearance and Mounting Hole Dimension

Remark: Φd is screw hole diameter for installing

Table 3-1 VFD500M series appearance and installation dimension

SIZE TYPE	Appearance and installation dimension (mm)						
	A	B	H	W	D	Φd	Mounting screws
SIZE A	66	137	145	75	115	$\phi 5.0$	M4×16
SIZE B	72	165	175	86	128	$\phi 5.0$	M4×16
SIZE C	108	225	235	120	158	$\phi 5.0$	M4×16

3.2Wiring

3.2.1 Standard wiring diagram

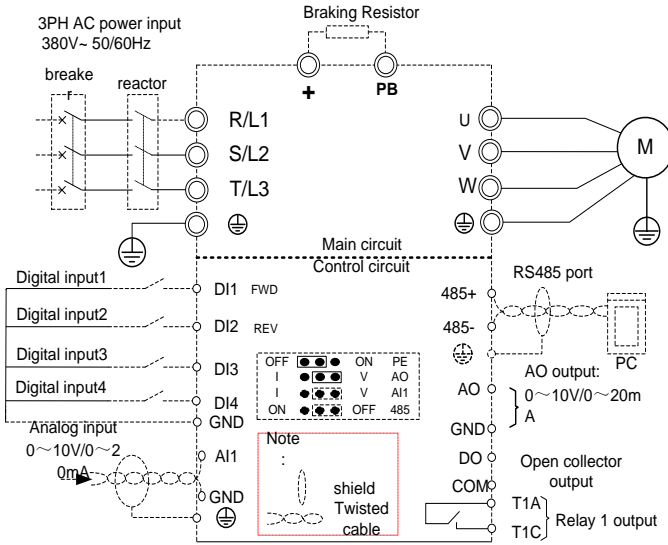

Figure 3-2 (SIZE A) standard wiring diagram

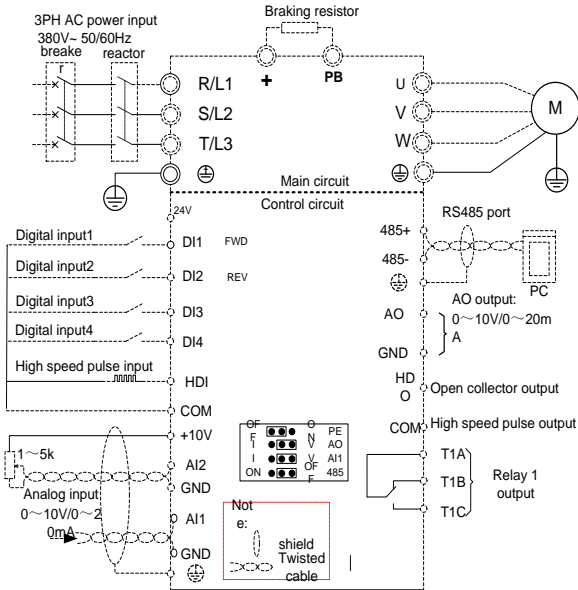

Figure 3-3 (SIZE B/C) standard wiring diagram

3.2.2 Main Circuit Terminals

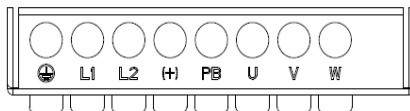

Figure 3-4 SIZE A main circuit terminal diagram

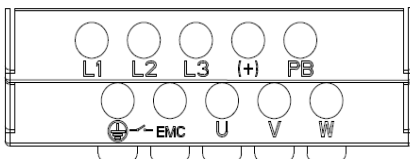

Figure 3-5 SIEZ B main circuit terminal diagram

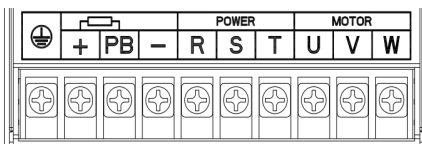

Figure 3-6 SIEZ C main circuit terminal diagram

Table 3-2 Function description of the main circuit terminal of the inverter

Terminal	Function instruction
L1、L2、L3	AC power input terminal, connect three-phase AC power (only L1/L2 is single phase inverter)
U、V、W	Inverter AC output terminal, connect three-phase AC motor
(+)、PB	Braking resistor connection terminal when built-in brake unit
⊕	Ground terminal, ground
EMC	Safety capacitor and varistor grounding selection screw

3.2.3 Terminal screws and wiring specifications

Table 3-3 Main circuit cable and screw specifications

Model number	Power terminal			Ground terminal		
	Screw	Tightening torque (N·m)	Cable diameter (mm ²)	screw	Tightening torque (N·m)	Cable diameter (mm ²)
3 phase voltage: 380V, 50/60Hz						
VFD500M-R75GT4B	M4	2	2.5	M4	2	2.5
VFD500M-1R5GT4B	M4	2	2.5	M4	2	2.5
VFD500M-2R2GT4B	M4	2	2.5	M4	2	2.5
VFD500M-4R0GT4B	M4	2	4	M4	2	4
VFD500M-5R5GT4B	M4	2	6	M4	2	6
VFD500M-7R5GT4B	M4	2	6	M4	2	6
Single phase voltage: 220V, 50/60Hz						
VFD500M-R40GS2B	M3	1.5	2.5	M3	1.5	2.5
VFD500M-R75GS2B	M3	1.5	2.5	M3	1.5	2.5
VFD500M-1R5GS2B	M4	2	2.5	M4	2	2.5
VFD500M-2R2GS2B	M4	2	4.0	M4	2	4.0

3.2.4 Cautions for Main Circuit Wiring

(1) Power Supply Wiring

- ◆ It is forbidden to connect the power cable to the output terminal of the inverter. Otherwise, the internal components of the inverter will be damaged.
- ◆ In order to provide input side overcurrent protection and power outage overhaul convenience, the inverter should be connected to the power supply through circuit breakers and contactors.
- ◆ Please confirm the power phase, the voltage is consistent with the product nameplate, do not match may result in damage to the inverter.

(2) DC wiring

- ◆ Do not connect the braking resistor directly to +, -, which may cause the inverter to be damaged or even fire.
- ◆ When using the external brake unit, pay attention to +, - can not be reversed, otherwise it will cause damage to the inverter and brake unit or even cause a fire.

(3) Motor Wiring

- ◆ It is forbidden to short circuit or ground the inverter output terminal, otherwise the internal components of the inverter will be damaged.
- ◆ Avoid short circuit the output cables or with the inverter enclosure, otherwise there exists the danger of electric shock.

- ◆ It is forbidden to connect the output terminal of the inverter to the capacitor or LC/RC noise filter with phase lead, otherwise, the internal components of the inverter may be damaged.
- ◆ When contactor is installed between the inverter and the motor, it is forbidden to switch on/off the contactor during the running of the inverter, otherwise, there will be large current flowing into the inverter, triggering the inverter protection action.
- ◆ Length of cable between the inverter and motor
 If the cable between the inverter and the motor is too long, the higher harmonic leakage current of the output end will produce by adverse impact on the inverter and the peripheral devices. It is suggested that when the motor cable is longer than 100m, output AC reactor be installed. Refer to the following table for the carrier frequency setting.

3.2.5 Control Circuit Terminal

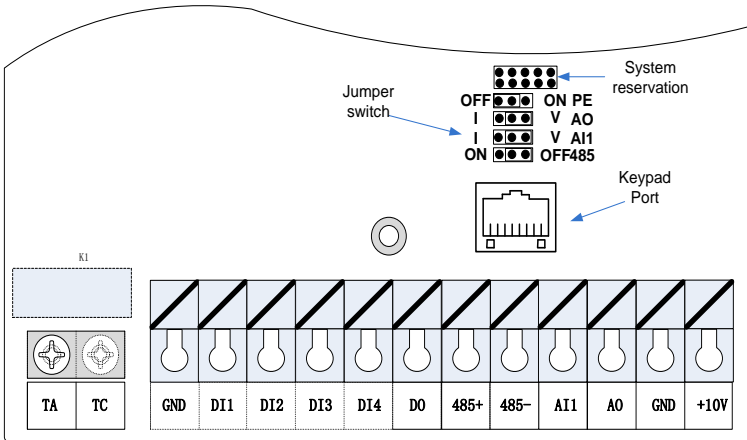

Figure 3-6 Schematic diagram of the VFD500M control circuit terminal (SIZE A)

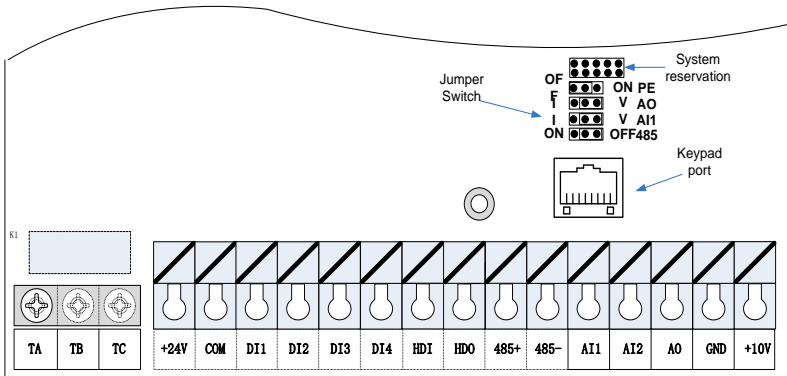

Figure 3-6 Schematic diagram of the VFD500M control circuit terminal (SIZE B/C)

Table 3-3 VFD500M control circuit terminal instruction

Type	Terminal Symbol	Terminal Name	Terminal function description	
Analog input voltage	+10V	Input voltage	10.10V±1%	
			Maximum output current:10mA, it provides power supply to external potentiometer with resistance range of: 1KΩ~51KΩ	
	GND	Analog ground	Internal isolation from COMThe factory PE and GND safety capacitors are OFF by default.	
	AI1	Analog input1	Input voltage:0~10V: Impedance 22KΩ, Maximum input voltage	
			Input current:0~20mA: Impedance 500Ω, Maximum input current	
				Through the jumper switch AI1 0 ~ 10V and 0 ~ 20mA analog input switch, the factory default voltage input.
AI2	Analog input 2(Size A Not support)	Input voltage:0~10V: Impedance 22KΩ, Maximum input voltage		
		Input current:0~20mA: Impedance 500Ω, Maximum input current		
			Through the jumper switch AI1 0 ~ 10V and 0 ~ 20mA analog input switch, the factory default voltage input.	
Analog output	AO	Analog output	Output voltage:0~10V: Impedance ≥10KΩ	
			Output current:0~20mA: Impedance 200Ω~500Ω	
			Through the jumper switch AO1 0 ~ 10V and 0 ~ 20mA analog output switching, the factory default voltage output.	
GND	Analog ground	Internal isolation from COM		
Switch input	+24V	+24V power(size A not support)	24V±10%, Internal isolation from GND	
			Maximum output current: 200mA	
				To provide 24V power supply, generally used as a digital input and output terminal power supply and external sensor power
	COM	+24V ground (size A not support)	Internal isolation from GND	
	DI1~DI4	Digital input terminal 1~4	Optocoupler isolation, compatible with bipolar input	
			Frequency range: 0~200Hz Voltage range: 10V~30V	
HDI	Digital input terminal /High-speed pulse input(size A not support)	Digital input terminal: same as DI1~DI4		
		Pulse input frequency input: 0~50KHz Voltage range: 10V~30V		
Switch output	DO1	Open collector output	Optocoupler isolation	
			Voltage range: 0V~24V	
			Current range: 0mA ~50mA	

Type	Terminal Symbol	Terminal Name	Terminal function description
	HDO	Open collector output(size A) /High-speed pulse output	Open collector output: same as DO1
			High-speed pulse output: 0~50KHz
Relay output 1	TA/TB/TC	Relay output	TA-TB: normal close (Size A support NC only)
			TA-T1C: normal open
			Contact rating: AC 250V, 3A; DC 30V, 1A
485 port	485+	485 Positive differential signal	Baud rate: 1200/2400/4800/9600/19200/38400/57600/115200bps(default to Factory default no matching resistor(off))
	485-	485 Negative differential signal	

◆ Switch input terminal instructions

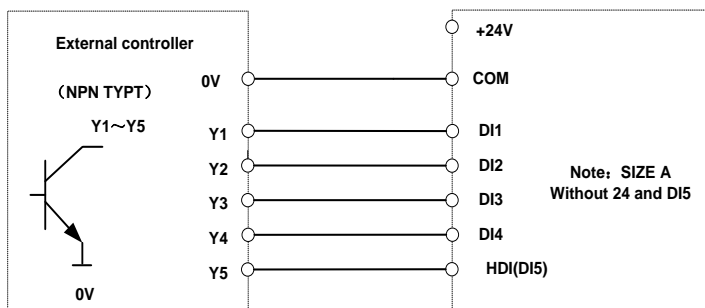

Figure 3-8 Wiring diagram of the digital input terminal

note:

1. If the external controller output is a relay contact, the “0V” or “VCC” of the external controller in the above figure can be considered as the common end of the relay.
2. This drive only supports one connection method.

Description of the digital output terminal The multi-function output terminals DO1 and HDO can be powered by the internal +24V power supply of the inverter or an external power supply. The wiring diagram is as follows:

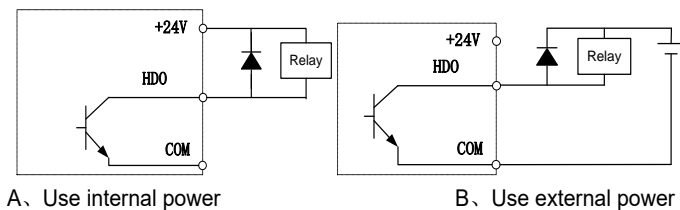

Figure 3-9 Wiring diagram of the switch output terminal

Note:

The multi-function terminal output is open collector output, and the maximum allowable current is 50mA. When using the internal power supply, if driving an inductive load, add an absorption circuit, such as an RC snubber circuit or a freewheeling diode. When adding a freewheeling diode, be sure to confirm the polarity of the diode, otherwise it will damage the product; For external power supply, connect the negative terminal of the external power supply to the COM terminal.

Chapter 4 Operation and display

4.1 LED Instruction of operation and display









LED keyboard consists of 5 digital tubes, 7 lights, 8 keys and a potentiometer; can be used to set the parameters, status monitoring and operation control, LED keyboard shape as shown in Figure 4-1:

Figure 4-1 Operating panel

Description of indicator

Table 4-1 The name and function of each part of the keyboard

No.	Part	Name	Function
1		Exit	<ul style="list-style-type: none"> • exit menu level
2		Confirmation	<ul style="list-style-type: none"> • Enter the menu interfaces level by level, • confirm the parameter setting and save to EEPROM
3		Increment/Up	<ul style="list-style-type: none"> • The number indicated by the cursor increases by one. • Next function code. • Used to switch the left and right screens while in monitor mode
4		Decrement/Down	<ul style="list-style-type: none"> • The number indicated by the cursor minus one. • The previous function code.
6		Shift	<ul style="list-style-type: none"> • Cursor shift. • Monitor Status Displays the next monitor volume. • Switch left and right screens.
7		Run	Start the frequency inverter in the operation panel control mode
8		Stop/Reset	<ul style="list-style-type: none"> • During operation, press to stop the operation (restricted by parameter 21.03). • In fault status, press this key to reset the fault.

9		Indicator light:Hz	·Always light: Hz ·flicker: Rpm
10		Indicator light:A	·Indicate the digital display unit, all three lights off means other units
11		Indicator light:V	
12		Running lights	• Off: indicates a stop condition. • On: indicates inverter is running. Blinking: Deceleration stopped.
13		Direction indicator	• Used to indicate the sign of the variable when the LED is displaying one of the variables listed in 27.02; • In other cases the sign of the output frequency is indicated.
15		STOP	When it is lit, it indicates that the inverter is faulty.

◆ 4-2 Keyboard operation diagram

◆ Standard mode (-bSC-)

If visiting access (P00.01) is standard, all the function codes mentioned in this manual are accessible.

If visiting access (P00.01) is the end user (in the state of user password lock), then only some function code can be accessed.

◆ User-defined mode (-USr-)

In this menu mode, only 20 user-defined parameters defined are displayed.

◆ Verify mode (-vrF-)

In this menu mode, only parameters that differ from the factory settings are displayed.

◆ Guide mode (-GdE-)

When users first use the inverter, can guide the user to complete a simple trial run.

4.2 Digital tube display

Display of decimal data

16 digits:

The range of unsigned numbers is 0 ~ 65535 (without decimal point). The displayed range of signed numbers is -9999 ~ 32767 (excluding decimal point). The negative numbers less than -9999 will be displayed as -9999.

32 digits:

The left and right screen display, combined with the following figure to illustrate:



Dot1 is used to distinguish between the left and right screens. On indicates the left panel (upper 5 digits) and turns off the right screen (lower 5 digits). When the left screen is displayed, Dot5 is used to indicate the sign digit. On indicates that the value is negative, off indicates the value is Positive.

The display range of 32-bit unsigned numbers is 0 to 4294967295 (excluding decimal point), and the displayed range of signed numbers is -2147483648 to 2147483647 (excluding the decimal point).

◆ Binary data display

Binary number currently only supports 16 digits, points left and right screen display.

The leftmost digital tube is used to distinguish the left and right screens: the top digit segment lights up for the left panel and the bottom segment lights for the right panel.

Remove the leftmost digital tube, from right to left, followed by Bit0 ~ Bit15. The upper segment is lit to indicate 1,

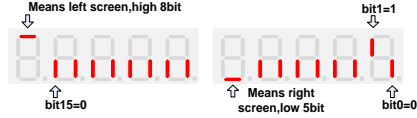

the lower segment to light to indicate 0.

◆ Display of Hexadecimal data

- ◆ The first segment of hexadecimal data displays "H.", and the subsequent 4 segments display the complete hexadecimal number, as shown in the figure below 0xE1AB=57771



◆ Parameter attribute identification

Editable parameters The leftmost LED displays "P"; the leftmost LED of the read-only parameter displays "r", as shown below.

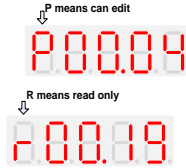

◆ Specific symbol

In some cases, the digital tube will display a specific symbol. The meaning of specific symbols is shown in the following table: Table4-2 Digital tube display symbol and meaning

Symbol	Meaning
tUnE	Motor parameter self-learning
bUSY	Processing parameter read and write requests
End	<ul style="list-style-type: none"> • Indicates that the parameters have been changed and saved to the EEPROM • The mission has been completed
Er.xxx	<ul style="list-style-type: none"> • Fault code, "XXX" is the fault type, see Chapter 6 for details

Chapter 5 Function Code Table

The following is the VFD500M parameter distribution list:

Classification	Parameter group	Page	
Common parameters	00:Basic function	Page 22	
	01:Frequency source selection	Page24	
	02:Start and stop	Page 29	
	03:Ramp and S curve	Page 31	
	04: Analog and pulse input	Page 33	
	05:Analog and pulse output	Page 36	
	06:Multi-function Digital input (DI)	Page 37	
	07: Multi-function Digital output(DO)	Page 40	
	08:Digital Output setting	Page 42	
	11:Motor1 parmeter	Page 44	
	12:Motor1 VFcontrol parameter	Page 46	
	13:Motor1 Vector controlparameter	Page 49	
	14:Torque control	Page 50	
	16:Energy saving control	Page 51	
	Display and protection	20:User-defined parameters	Page 52
		21:Keypad and display	Page 53
22:AC Drive configuration		Page 55	
23:Drive protection function setting		Page 57	
24:Motor protection parameter		Page 60	
25:Fault tracking parameter		Page 62	
26:Fault recording parameter		Page 62	
Communication	27:Monitoring parameter	Page 64	
	30:Modbus communication	Page 65	
Application	40:Process PID Function	Page 67	
	41:Sleep function	Page 71	
	42:Simple PLC	Page 72	
	43:Programmable delay unit	Page 74	
	44:Comparator and logic unit/controller	Page 76	
Motor 2	45:Multifunction counter	Page 80	
	60:Motor2 basic parameter	Page 82	
	61:Motor2 parameter	Page 82	
	62:Motor2 VF control parameter	Page 82	
	63:Motor2 vector control parameter	Page 82	

Term Description:

The parameter is also called function code; the operation panel is also called the keyboard.

Due to usage habits, different terms may be used in different places in this manual, but all refer to the same content.

Symbol Description:

"☆" means that the setting value of this parameter can be changed when the inverter is stopped or running.

"★" means that the setting value of this parameter can not be changed when the inverter is running.

"●" indicates that the value of this parameter is the actual test record value, which can not be changed

Function code	Parameter name	Description	Default	Property
00Group Basic Function				
P00.00	User password	0 ~ 65535 > No user password status (P00.01 = 1 after power-on): Entering the same non-zero value twice in succession sets a user password and enters lockout. > Password lock state: Enter the password to enter the unlock state. > Unlocked state: Enter the original password to enter the lock state; enter the same value twice in a row to change the password (clear the password if you enter 0 twice in a row).	0	☆
P00.01	Access authority	0: END USER Some parameter are not authorized to check when user password in locked state 1: Standard ALL Parameter can be checked	1	★
P00.03	RESET	0: NO ACTION 11: Restore default parameter except for motor parameter and auto-tune related parameter and factory parameter 12: Restore default to factory parameter 13: Clear tripping record	0	★
P00.04	Motor Control mode	0: VF 1: SVC(sensorless vector control) > Open loop vector and torque control without encoder feedback	0	★
P00.05	Running mode	0: Speed mode 1: Torque mode > If use with DI function, 19: Switch between torque and speed Control and 20: torque control disabled. Actual effective running mode is related with DI status	0	★
P00.06	Source of the Operation Command	0: keypad 1: terminal 2: communication > Command source: run、stop、forward、reverse、jog、fast brake stop.etc > If use with DI function, 12: Switching run command to Keypad and 13: Switching run command to Communication, Actual effective command source is related with	0	★

Function code	Parameter name	Description	Default	Property
		DI status		
P00.07	Numeric frequency setting	00.00Hz~maximum frequency(Set P21.17=1 to change its unit to 1Rpm)	50.00Hz	☆
P00.08	Rotation direction	0: Forward 1: Reverse > It is only for keypad control to change running direction by giving frequency symbol to be reverse)If command by keypad/terminal /communication,and not want to achieve reverse running by giving frequency symbol to be reverse,need to change P22.13 in stop mode(see parameter P22.13)	0	☆
P00.09	Reverse control	0: enable 1: disbale	0	★
P00.10	Motor option	0: motor 1 1: motor 2 If use with DI function,16:Switch between motor 1 and motor 2,Actual effective command source is related with DI status	0	★
P00.11	Special industry	0: Standard drive 1: Reserved	0	★
r00.18	Power board software version	-	-	•
r00.19	Control board software version	-	-	•
r00.21	SN 1	-	-	•
r00.22	SN 2	-	-	•

Function code	Parameter name	Description	Default	Property
01Group frequency source selection				
P01.00	Main frequency source selection (A)	0: Digital setting 1: AI1 2: AI2 3: Reserved 4: Reserved 5: HDI 6: multi-step speed 7: communication 8: PID 9: Internal PLC 10: Potentiometer Notice: DI terminal function code 26-32 superior than this function code	10	★
P01.01	Auxiliary frequency source selection (B)	Same as P01.00 Notice: DI terminal function code 33 superior than this function code	0	★
P01.02	Reference option for auxiliary frequency source	0: Relative to Maximum frequency 1: Relative to main frequency	0	★
P01.03	Auxiliary frequency gains	0.0~300.0	100.0%	☆
P01.04	Frequency source selection	0: main frequency sourceA 1: auxiliary frequency sourceB 2: Main and auxiliary arithmetic results 3: Switchover between main and auxiliary frequency 4: switchover between main frequency source A and A+B Arithmetic results 5: Switchover between B and (A+B) (*) DI function code 25 effective to corresponding terminal ,frequency will adopt the latter	0	★
P01.05	Main and Auxiliary arithmetic	0: A+B 1: A-B 2: The bigger of main A and Auxiliary B 3: The smaller of Main A and Auxiliary B 4: A*B	0	★
P01.06	Maximum frequency	10.00~600.00Hz	50.00Hz	★
P01.07	Upper limit frequency control	0: digital setting (set through P01.08) 1: AI1 2: AI2 3: Reserved 4: Reserved 5: Pulse setting HDI	0	★

Function code	Parameter name	Description	Default	Property
		6: Reserved 7: Communication setting 8: Reserved 9: Reserved 10: Potentiometer		
P01.08	Upper limit frequency	Lower limit frequency(P01.09)~maximum frequency (P01.06)	50.00Hz	☆
P01.09	Lower limit frequency	0.00Hz~upper limit frequency	0.00Hz	☆
P01.10	Action when set frequency lower than lower limit frequency	0: Run at low limit frequency 1: Stop after delaying P01.11 2: Run at zero speed	0	★
P01.11	Delay time when set frequency lower than lower limit frequency	0.000s~30.000s	0.000s	★
P01.12	Jump frequency start up protection	Unit/ten/hundred'digit: three jump frequency 1/2/3 0: Disable 1: Enable (avoid risk speed)	000	☆
P01.13	Jump frequency 1 lower limit	0.00Hz~(P01.14)	0.00Hz	☆
P01.14	Jump frequency upper limit	P01.13- (P01.06)Maximum frequency	0.00Hz	☆
P01.15	Jump frequency 2 lower limit	0.00Hz~(P01.16)	0.00Hz	☆
P01.16	Jump frequency 2 upper limit	P01.15~maximum frequency(P01.06)	0.00Hz	☆
P01.17	Jump frequency 3 lower limit	0.00Hz~(P01.18)	0.00Hz	☆
P01.18	Jump frequency 3 upper limit	P01.17~maximum frequency(P01.06)	0.00Hz	☆

Risk speed or Jump frequency start up protection is used to some situation which need avoid motor speed and speed range,for example,due to mechanical resonance ,P01.12 will be enabled to avoide risk speed in forward or reverse mode

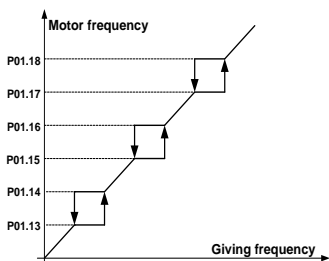

Function code	Parameter name	Description	Default	Property
P01.19	Multi-step speed reference source	Unit digit: 0 phase reference source set by 0-multi-step speed(P01.21) 1-preset frequency (P00.07) 2:AI1 3:AI2 4:Reserved 5:Reserved 6:HDI pulse 7:Communication 8:PID Ten's digit: Combination of multiple speed 0: Combination method 1: Priority method	00	★

Combination method Description:

Multispeed terminal 4	Multispeed terminal 3	Multispeed terminal 2	Multispeed terminal 1	Combination method Speed reference
Ineffective	Ineffective	Ineffective	Ineffective	Multispeed 0
Ineffective	Ineffective	Ineffective	effective	Multispeed 1
Ineffective	Ineffective	effective	Ineffective	Multispeed 2
Ineffective	Ineffective	effective	effective	Multispeed 3
Ineffective	effective	Ineffective	Ineffective	Multispeed 4
Ineffective	effective	Ineffective	effective	Multispeed 5
Ineffective	effective	effective	Ineffective	Multispeed 6
Ineffective	effective	effective	effective	Multispeed 7
effective	Ineffective	Ineffective	Ineffective	Multispeed 8
effective	Ineffective	Ineffective	effective	Multispeed 9
effective	Ineffective	effective	Ineffective	Multispeed 10
effective	Ineffective	effective	effective	Multispeed 11
effective	effective	Ineffective	Ineffective	Multispeed 12
effective	effective	Ineffective	effective	Multispeed 13
effective	effective	effective	Ineffective	Multispeed 14
effective	effective	effective	effective	Multispeed 15

Priority method Description:

Multispeed terminal 4	Multispeed terminal 3	Multispeed terminal 2	Multispeed terminal 1	Priority method Speed reference
Ineffective	Ineffective	Ineffective	Ineffective	Multispeed 0
Ineffective	Ineffective	Ineffective	effective	Multispeed 1
Ineffective	Ineffective	effective	random	Multispeed 2
Ineffective	effective	random	random	Multispeed 3
effective	random	random	random	Multispeed 4

P01.20	Multiple step speed	Bit0 ~ 15 corresponding to 0 ~ 15 phase	0	☆
--------	---------------------	---	---	---

Function code	Parameter name	Description	Default	Property
	Rotation direction	direction 0:forward direction 1:reverse direction		
P01.21	Multiple step speed 0/in-built plc 1	Lower limit frequency (P01.09) ~ maximum frequency (P01.06)	0.00Hz	☆
P01.22	Multiple step speed 1/in-built plc 2	Lower limit frequency(P01.09) ~ maximum frequency(P01.06)	0.00Hz	☆
P01.23	Multiplestep speed 2/in-built plc 3	Lower limit frequency(P01.09) ~ maximum frequency(P01.06)	0.00Hz	☆
P01.24	Multiple step speed 3/in-built plc 4	Lower limit frequency(P01.09) ~ maximum frequency(P01.06)	0.00Hz	☆
P01.25	Multiple step speed 4/in-built plc 5	Lower limit frequency(P01.09) ~ maximum frequency(P01.06)	0.00Hz	☆
P01.26	Multiple-step speed 5/in-built plc 6	Lower limit frequency(P01.09) ~ maximum frequency(P01.06)	0.00Hz	☆
P01.27	Multiple step speed 6/in-built plc 7	Lower limit frequency(P01.09) ~ maximum frequency(P01.06)	0.00Hz	☆
P01.28	Multiple step speed 7/in-built plc 8	Lower limit frequency(P01.09) ~ maximum frequency(P01.06)	0.00Hz	☆
P01.29	Multiple step speed 8/in-built plc 9	Lower limit frequency(P01.09) ~ maximum frequency(P01.06)	0.00Hz	☆
P01.30	Multiple step speed 9/in-built plc 10	Lower limit frequency(P01.09) ~ maximum frequency(P01.06)	0.00Hz	☆
P01.31	Multiple step speed 10/in-built plc 11	Lower limit frequency(P01.09) ~ maximum frequency(P01.06)	0.00Hz	☆
P01.32	Multiple step speed 11/in-built plc 12	Lower limit frequency(P01.09) ~ maximum frequency(P01.06)	0.00Hz	☆
P01.33	Multiple step speed 12/in-built plc 13	Lower limit frequency(P01.09)~maximum frequency(P01.06)	0.00Hz	☆
P01.34	Multiple step speed 13/in-built plc 14	Lower limit frequency(P01.09)~maximum frequency(P01.06)	0.00Hz	☆
P01.35	Multiple step speed 14/in-built plc 15	Lower limit frequency(P01.09)~maximum frequency(P01.06)	0.00Hz	☆
P01.36	Multiple step speed 15/in-built plc 16	Lower limit frequency(P01.09)~maximum frequency(P01.06)	0.00Hz	☆
P01.37	Jog frequency	0.00Hz~maximum frequency(P01.06)	5.00Hz	☆
P01.38	Jog command when running	0: not responsive 1: responsive	0	★
P01.39	UP/DOWN rates	0.00(auto rates)~600.00Hz/s	1.00Hz/s	☆
P01.40	UP/DOWN Control	Unit digit: 0: Zero clearing in non-running 1: Zero clearing when UP/DOWN command not effective 2: Not zero cleaning (decide by remembering)	000	★

Function code	Parameter name	Description	Default	Property
		digit when power failure Ten's digit: 0: Non-zero cleaning at power failure 1: Save at power failure UP/DOWN offset Hundred's digit: UP/DOWN near to zero 0: Forbidden 1: Enable		
P01.41	Droop control gains	0.00~1.00 Rotation speed drop value based on Rated load (relative to maximum frequency) Frequency drop volume: Max frequency*P01.41*Current load/rated load	0.00	☆
P01.42	Droop control filtering time	0.000s~10.000s	0.050s	☆
P01.43	Textile frequency setting	0: relative to center of textile frequency 1: relative to maximum frequency	0	☆
P01.44	Textile frequency	0.0%~100% relative to center of textile frequency P01.43 = 0: Textile frequency $A_w = P01.44 * \text{center frequency}$ P01.43 = 1: Textile frequency $A_w = P01.44 * \text{max frequency}$	0.0%	☆
P01.45	Jump frequency	0.0%~50.0% relative to textile frequency	0.0%	☆
P01.46	Textile period	0.1s~3000.0s	10.0s	☆
P01.47	Triangle wave rising time coefficient	0.1%~100.0% relative to textile period	50.0%	☆
P01.48	Auxiliary frequency effective threshold	When the main frequency \geq this setting, the auxiliary frequency will be activated.	0.00HZ	☆

Function code	Parameter name	Description	Default	Property
		<p>This function is mostly used in textile and chemical industry and some application such as traversing and winding so it is used for balancing the workload allocation when multiple motors are used to drive the same load. The output frequency of the frequency inverters decreases as the load increases. You can reduce the workload of the motor under load by decreasing the output frequency for this motor, implementing workload balancing among multiple motors. P01.44 or P01.46=0, This function disable</p>		

Function code	Parameter name	Description	Default	Property
02 Group Start and stop Control				
P02.00	Starting mode	<p>0: Direct start Inverter will start from P02.01,After P02.02,It will go to setting frequency as per S curve</p> <p>1: Speed tracking/Searching Inverter will do search for motor speed and recognize and accelerate and decelerate to setting frequency.See Parameter P02.16-P02.19</p>	0	★
P02.01	Startup frequency	0.00Hz~10.00Hz	0.00Hz	★
P02.02	Startup frequency holding time	0.000s~10.000s	0.000s	★
P02.03	Quick-response excitation	<p>0: Disable 1: Enable</p> <p>Set 1= enable it will automatically calculate pre-excitation current P02.04 and pre-excitation time ,after finishing calculation,this parameter will reset to 0</p>	0	★
P02.04	Pre-excitation current	0%~200% motor rated current	Depend	★
P02.05	Pre-excitation time	<p>0.00s~10.00s</p> <p>Pre-excitation enable Asynchronous motor for magnetic field for higher starting torque</p>	Depend	★
P02.06	DC brake current at start-up	0~100% motor rated current	100%	☆
P02.07	DC brake time at start-up	0.000s~30.000s	0.000s	★
P02.08	Stop method	<p>0: Ramp to stop 1: Free coast to stop</p>	0	☆
P02.09	Startup frequency of DC brake at stop	0.00Hz~50.00Hz	1.00Hz	★
P02.10	DC braking current at stop	0~100% motor rated current(Maximum value not higher than drive rated current)	100%	☆
P02.11	DC brake time at stop	0.000s~30.000s	0.000s	★
P02.12	Magnetic flux brake gain	<p>1.00~1.50</p> <p>Over excitation braking convert some kinetic energy to motor heating by increasing motor excitation.value 1 means ineffective: value higher,better performance but output current bigger</p>	1.00	★
P02.13	Delaying frequency at stop	0.00Hz~20.00Hz	0.50Hz	★
P02.14	Delaying time at stop	<p>0.000s~60.000s</p> <p>0.000s:no function for delaying time at stop >0.000s:it is effective,when output frequency</p>	0.000s	★

Function code	Parameter name	Description	Default	Property
		decrease lower than delaying frequency at stop (P02.13),inverter will block pulse output after delaying time at stop (P02.14).if run command comes during delaying time,inverter will restart.it is useful to some application with jog function		
P02.15	The minimum blocking time after free stop	0.010s~30.000s	Depend	★
P02.16	Speed search mode	Unit's digit: tracking mode 0: speed search for maximum output frequency 1: speed search for frequency at stop 2: speed search for grid frequency Ten's digit: direction choosing 0: only search at given frequency direction 1: search on the other direction when failed for given frequency tracking	10	★
P02.17	Deceleration time for speed search	0.1s~20.0s	2.0s	★
P02.18	Current for speed search	10%~150% motor rated current	40%	★
P02.19	Speed search compensation factor	0.00~10.00	1.00	★

Function code	Parameter name	Description	Default	Property
03 Group Ramp and S curve				
P03.00	Acceleration and deceleration curve selection	0: linear 1: S curve A 2: S curve B	0	★
<p>Acceleration and deceleration curve, also known as "Ramp Frequency Generator (RFG)", is used to smooth the frequency command. VFD500M supports the following acceleration and deceleration curve:</p> <p>0: linear acceleration / deceleration</p> <p>The output changes at a constant acceleration or deceleration. Acceleration time refers to the time from when the inverter accelerates from zero to the reference frequency (selected by P03.15); deceleration time refers to the time required to decelerate from the reference frequency to zero.</p> <p>1: S curve method</p> <p>This acceleration and deceleration curve acceleration "a" changes in a ramp, start and stop relatively flat. Acceleration and deceleration process as shown below, Tacc and Tdec for the set acceleration and deceleration time.</p> <p>The acceleration and deceleration curve of the equivalent acceleration and deceleration time:</p> <p>Acceleration time = $T_{acc} + (T_{s1} + T_{s2}) / 2$</p> <p>Deceleration time = $T_{dec} + (T_{s3} + T_{s4}) / 2$</p> <div style="text-align: center;"> </div>				
<p>2: S curve method B</p> <p>The time of this S-curve is defined as in the method A except that in the acceleration / deceleration process, if the target frequency suddenly approaches or the acceleration / deceleration time changes, the S-curve is re-planned. In addition, when the target frequency changes, the S Curves avoid "overshoot" as much as possible.</p>				
P03.01	Acceleration time 1	Setting value depend on P03.16 P03.16 = 2, 0.00~600.00s; P03.16 = 1, 0.0s~6000.0s; P03.16 = 0, 0s~60000s	Depend on model	☆
P03.02	Deceleration time 1	Setting value depend on P03.16 P03.16 = 2, 0.00~600.00s; P03.16 = 1, 0.0s~6000.0s; P03.16 = 0, 0s~60000s	Depend on model	☆
P03.03	Acceleration time2	0.01~60000s same as P03.01	Depend on model	☆
P03.04	Deceleration time2	0.01~60000s same as P03.02	Depend on model	☆
P03.05	Acceleration time3	0.01~60000s same as P03.01	Depend on model	☆

Function code	Parameter name	Description	Default	Property
P03.06	Deceleration time3	0.01~60000s same as P03.02	Depend on model	☆
P03.07	Acceleration time4	0.01~60000s same as P03.01	Depend on model	☆
P03.08	Deceleration time4	0.01~60000s same as P03.02	Depend on model	☆

The VFD500M provides four groups of acceleration and deceleration time. The actual acceleration / deceleration time can be selected by different methods such as DI terminal, output frequency and PLC running segments. Several methods can not be used at the same time. Factory default is to use acceleration / deceleration time

1. DI terminal select acceleration and deceleration time of the mapping table is as follows.:

Acceleration and deceleration time terminal 2	Acceleration and deceleration time terminal 1	Acceleration and deceleration time terminal
OFF	OFF	Acceleration and deceleration time terminal 1 (P03.01,P03.02)
OFF	ON	Acceleration and deceleration time terminal 2 (P03.03,P03.04)
ON	OFF	Acceleration and deceleration time terminal 3 (P03.05,P03.06)
ON	ON	Acceleration and deceleration time terminal 4 (P03.07,P03.08)

The schematic diagram of selecting acceleration / deceleration time according to the output frequency is as follows.:

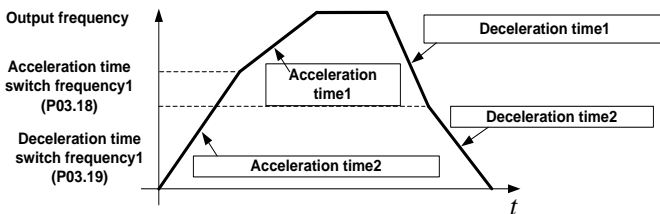

Other ways to select acceleration / deceleration time can be found in the description of relevant parameters.

P03.09	Jog Acceleration time	Time Setting same as P03.01	6.00s	☆
P03.10	Jog Deceleration time	Time Setting same as P03.02	10.00s	☆
P03.11	S-curve Acceleration begin time	Setting value depend on P03.16 P03.16 = 2, 0.01~30.00s; P03.16 = 1, 0.1s~300.0s; P03.16 = 0, 1s~3000s	0.50s	☆
P03.12	S-curve Acceleration arrival time	SAME AS P03.11	0.50s	☆
P03.13	S-curve Deceleration	SAME AS P03.11	0.50s	☆

Function code	Parameter name	Description	Default	Property	
	begin time				
P03.14	S-curve Deceleration Arrival time	SAME AS P03.11	0.50s	☆	
P03.15	Accel and Deceltime frequency benchmark	0: maximum frequency 1: Motor rated frequency	0	★	
P03.16	Accel and Decel time unit selection	0: 1s 1: 0.1s 2: 0.01s	2	★	
P03.17	Quickstop deceleration time	0.01~65000s	5.00s	☆	
P03.18	Switchingfrequency 1 in acceleration time	0.00Hz~maximum frequency(P01.06)	0.00Hz	☆	
P03.19	Switchingfrequency 1 in deceleration time	0.00Hz~maximum frequency(P01.06)	0.00Hz	☆	
P03.20	Forward/reverse Dead band time	0.00s~30.00s Waiting time for zero speed during forward and reverse switchover	0.00s	★	
04 Group Analog and Pulse input					
P04.00	Minimum input pulse frequency	0.00kHz~ 50.00kHz		1.00kHz	☆
P04.01	Maximum input pulse frequency	0.00kHz~ 50.00kHz		30.00kHz	☆
P04.02	Setting Corresponding to Minimum input	-100.0%~ 100.0%		0.0%	☆
P04.03	Setting Corresponding to maximum input	-100.0%~ 100.0%		100.0%	☆
P04.04	Pulse input filter time	0.000s~10.000s		0.050s	☆
r04.05	Pluse input frequency	0.00kHz~50.00kHz(it is used to check HDI pulse input frequency)		-	●
r04.06	HDI equivalent value	-100.0%~100.0%(it is used to View the output of the HDI mapping curve)		-	●
P04.07	AI 1 Curve setting	Unit's: AI curve selection 0: curve A 1: curve B 2: Curve C		00	★

Function code	Parameter name	Description	Default	Property
		3: Curve D Ten'unit: when input signal lower than minimum input 0: equal to minimum input 1: equal to 0.0%		
P04.08	AI1 filter time	0.000s~10.000s	0.100s	☆
r04.09	AI 1 actual value	0.00V~10.00V (it is used to view the port voltage of AI1. When AI1 is a current type (0~20mA) input, multiplying this value by 2 is the input current (mA) of the AI1 port.)	-	●
r04.10	AI 1 Conversion value	-100.0%~100.0%(It is used to view the output of the AI1 mapped curve)	-	●
P04.11	AI 2 Curve setting	Unit's: AI curve selection 0: curve A 1: curve B 2: Curve C 3: Curve D Ten'unit: when input signal lower than minimum input 0: equal to minimum input 1: equal to 0.0%	01	★
P04.12	AI2 filter time	0.000s~10.000s	0.100s	☆
r04.13	AI 2 actual value	0.00V~10.00V (it is used to view the port voltage of AI2. When AI2 is a current type (0~20mA) input, multiplying this value by 2 is the input current (mA) of the AI2 port.)	-	●
r04.14	AI 2 Conversion value	-100.0%~100.0%(It is used to view the output of the AI2 mapped curve)	-	●
P04.23	Curve A horizontal axis 1	0.00V~ P04.25	0.00V	☆
P04.24	Curve A vertical axis 1	-100.0%~ 100.0%	0.0%	☆
P04.25	Curve A horizontal axis 2	P04.23~ 10.00V	10.00V	☆
P04.26	Curve A vertical axis 2	-100.0%~ 100.0%	100.0%	☆
		<p>Note: Input less than P04.23, output decided by curve ten's digit</p>		
P04.27	Curve B horizontal axis 1	0.00V~ P04.29	0.00V	☆

Function code	Parameter name	Description		Default	Property
P04.28	Curve B vertical axis 1	-100.0%~ 100.0%	<p>Note: Input less than P04.27, output decide by curve ten's digit</p>	0.0%	☆
P04.29	Curve B horizontal axis 2	P04.27~ 10.00V		10.00V	☆
P04.30	Curve B vertical axis 2	-100.0%~ 100.0%		100.0%	☆
P04.31	Curve C horizontal axis 1	0.00V~ P04.33	<p>Note: Input less than P04.31, output decided by curve ten's digit</p>	0.00V	☆
P04.32	Curve C vertical axis 1	-100.0%~ 100.0%		0.0%	☆
P04.33	Curve C horizontal axis 2	P04.31~ P04.35		3.00V	☆
P04.34	Curve C vertical axis 2	-100.0%~ 100.0%		30.0%	☆
P04.35	Curve C horizontal axis 3	P04.33~ P04.37		6.00V	☆
P04.36	Curve C vertical axis 3	-100.0%~ 100.0%		60.0%	☆
P04.37	Curve C horizontal axis 4	P04.35~ 10.00V		10.00V	☆
P04.38	Curve C vertical axis 4	-100.0%~ 100.0%		100.0%	☆
P04.39	Curve D horizontal axis 1	0.00V~ P04.41	<p>Note: Input less than P04.39, output decided by curve ten's digit</p>	0.00V	☆
P04.40	Curve D vertical axis 1	-100.0%~ 100.0%		0.0%	☆
P04.41	Curve D horizontal axis 2	P04.39~ P04.43		3.00V	☆
P04.42	Curve D vertical axis 2	-100.0%~ 100.0%		30.0%	☆
P04.43	Curve D horizontal axis 3	P04.41~ P04.45		6.00V	☆
P04.44	Curve D vertical axis 3	-100.0%~ 100.0%		60.0%	☆
P04.45	Curve D horizontal axis 4	P04.43~ 10.00V		10.00V	☆

Function code	Parameter name	Description		Default	Property
P04.46	Curve D vertical axis 4	-100.0%~ 100.0%		100.0%	☆
<p>Description: The range of HDI, AI1 ~ AI4 mapping curve:</p> <ul style="list-style-type: none">➤ For frequency setting, 100% corresponds to the maximum frequency P01.06.➤ For torque setting, 100% corresponds to the maximum torque P14.02.➤ For other uses, see the description of the relevant function.					

05 Group Analog and Pulse output				
r05.00	Actual output Pulse frequency	0.00kHz~50.00kHz	-	●
P05.01	HDO Pulse Output type	0: Common numeric output (DO2 P07.02) 1: high frequency pulse output (Hdo)	0	☆
P05.02	High frequency pulse output function(HDO)	0: Running frequency (0~max frequency) 1: Set frequency (0~max frequency) 2: output current (0~2times motor rated current) 3: output torque(0~3times motor rated torque) 4: set torque(0~3times motor rated torque) 5: output voltage (0~2times motor rated voltage) 6: DC bus voltage (0~2times drives standard DC bus voltage) 7: output power (0~2times motor rated power) 8:encoder rotating speed(0-maximum frequency rotating speed) 9: AI1 (0.00~10.00V) 10: AI2 (0.00~10.00V) 11: AI1 (0.00~10.00V) 12: AI2 (0.00~10.00V)	0	☆
P05.03	HDO Minimum output pulse frequency	0.00kHz~50.00kHz HDO terminal output pulse frequencywhen Output signal source=0	1.00kHz	☆
P05.04	HDO Max output pulse frequency	0.00kHz~50.00kHz HDO terminal output pulse frequencywhen Output signal source=maximum value	30.00kHz	☆
r05.05	AO1 actual value	0.0%~100.0%	-	●
P05.06	AO1 output function signal selection	Same as P05.02	0	☆
P05.07	AO1 output offset	-100.0%~100.0%	0.0%	☆
P05.08	AO1 output gain	-10.00~10.00	1.00	☆
<p>The output error of AO1 can be corrected by P05.07 and P05.08, or the mapping relationship between signal source and actual output can be changed. The formula is:</p> $AO.c = P05.07 + P05.08 \times AO.p$ <p>AO.c: the actual output of AO1; AO.p: AO1 Value before correction and AO.c, AO.p, 100.0% of P05.07 corresponds to 10V or 20mA.</p>				

06 Group Multi-function Digital input				
r06.00	DI port status	Bit0~Bit6 Correspond to DI1~DI7 Bit12~Bit15 Correspond to VDI1~VDI4	-	●
P06.01	DI1 Numeric input function	0: No function 1: Run terminal 2: Reverse/Forward and reverse switchover 3: Three wire control 4: Forward jog command 5: Reverse jog command 6: Terminal UP 7: Terminal DOWN 8: Clear up UP/DOWN offset 9: Coast to stop/free stop	1	★
P06.02	DI2 Numeric input function	10: Fault reset 11: Reverse forbidden 12: Switching run command to Keypad 13: Switching run command to Communication 14: fast stop 15: external stop	2	★
P06.03	DI3 Numeric input function	16: Switch between motor 1 and motor 2 17: Pause operatoin 18: DC braking 19: Switch between torque and speed Control 20: torque control disabled 21: Multi-step speed terminal 1 22: Multi-step speed terminal2 23: Multi-step speedterminal3 24: Multi-step speed terminal4	4	★
P06.04	DI4 Numeric input function	25: frequency source switchover 26: Switch main frequency source to Numeric frequency setting	10	★
P06.05	DI5(HDI) Numeric input function	27: Switch main frequency source to AI1 28: Switch main frequency source to AI2 29: Switch main frequency source to AI3 30: Switch main frequency source to AI4 31: Switch main frequency source to high-frequency pulse input	0	★
P06.13	VDI1 Numeric input function (Virtual DI)	32: Switch main frequency source to communication setting 33: Switch auxiliary frequency source to numeric frequency setting	0	★
P06.14	VDI2 Numeric input function (Virtual DI)	34: Accel and Decel time terminal 1 35: Accel and Decel time termina2 36: Accel and Decel Stop 37: User-defined fault 1	0	★
P06.15	VDI3 Numeric input function (Virtual DI)		0	★
P06.16	VDI4 Numeric input function (Virtual DI)		0	★

		<p>38: User-defined fault 2 39: PID pause 40: PID integral pause 41: PID parameter Switchover 42: PID Positive/negative reaction switch 43: Preset PID terminal 1 44: Preset PID terminal 2 45: PID Main and Auxaliary command switch 46: PID Main and Auxaliary feedback switch 47: Simple PLC status reset 48: Simple PLC time stop 49: swing frequency stop 50: Counter 1 input 51: Counter 1 reset/clear 52: Counter 2 input 53: Counter 2 reset/clear 54: Clear/reset timed running time 55: Motor 2 Accel and Decel time selection</p>		
P06.17	Virtual input source	<p>Unit: VDI1 input source 0-F: P06.33 specifies the bit0-bit15 of the parameter Tens'DIGIT: VD2 input source 0-F: P06.34 bit0-bit15 of the specified parameter Hundreds'DIGIT: VD3 input source 0-F: P06.35 bit0-bit15 of the specified parameter Thousands: VD3 input source 0-F: P06.36 specifies the bit 0-bit15 of the parameter.</p>	0003	★
P06.18	DI Forcing function	<p>Define as per bit :disable;1:enable Bit0-bit11:DI1-DI12 Bit12-bit15:VDI1-VDI4 When the bit is enabled, the state of the DI or VDI is set by the corresponding bit of P06.19.</p>	H00000000 L000000000	★
P06.19	DI Forcing data	<p>Define as per bit 0:effective;1:ineffective Bit0-bit11:DI1-DI12 Bit12-bit15:VDI1-VDI4</p>	0	☆
P06.20	Effective logic of Numericinput terminal	<p>Define as per bit 0:positive logic;1:negative logic Bit0-bit11:DI1-DI12 Bit12-bit15:VDI1-VDI4 In the reverse logic, the inactive level of the DI terminal becomes the active level, and the active level becomes the inactive level.</p>	0	★
P06.21	DI1 Effective delay time	0.000s~30.000s	0.000s	☆
P06.22	DI1 ineffective delay time	0.000s~30.000s	0.000s	☆
P06.23	DI2 Effective delay time	0.000s~30.000s	0.000s	☆
P06.24	DI2 ineffective delay time	0.000s~30.000s	0.000s	☆
P06.25	DI3 Effective delay time	0.000s~30.000s	0.000s	☆

P06.26	DI3 ineffective delay time	0.000s~30.000s	0.000s	☆
P06.27	DI4 Effective delay time	0.000s~30.000s	0.000s	☆
P06.28	DI4 ineffective delay time	0.000s~30.000s	0.000s	☆
P06.29	Two wire/3wire operation control	0: 2-wire mode (FWD+REV)1 1: 2-wire mode RUN+DIRECTION)2 2: 3-wire 1(FWD+REV+ENABLE) 3: 3-wire 2 RUN +FWD/REV+ENABLE	0	★

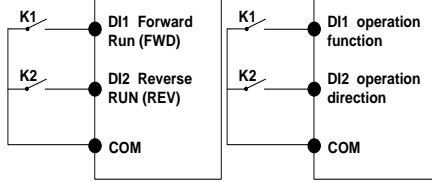

Figure1: Two-line mode 1

Figure 2: Two-line mode2

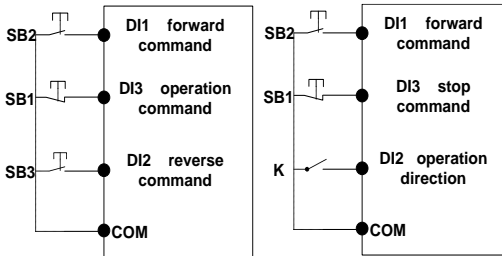

Figure 3: Three-line mode1

Figure 4: Three-line mode2

Two-line mode 1:

K1 is closed, the drive is running forward, K2 closed reverse operation, K1, K2 at the same time closed or disconnected, the inverter stops running.

Two-line mode 2:

In K1 closed state, K2 disconnect the inverter forward, K2 closed inverter reverse; K1 off the inverter to stop running.

Three-line mode 1:

DI3 is set to three-wire control function. When the SB1 button is closed, press the SB2 button. The inverter is forward running. Press the SB3 button to invert the inverter. When the SB1 button is off, the inverter will stop. During normal start-up and running, it is necessary to keep the SB1 button closed, and the commands of SB2 and SB3 buttons take effect during the closing operation. The running status of the inverter takes the last key action of the three buttons as the standard.

Three-line mode 2:

DI3 is set to three-wire control function. When the SB1 button is closed, press the SB2 button to run the inverter, K to switch the inverter forward, K to close the inverter and SB1 to turn off the inverter. During normal start-up and operation, it is necessary to keep the SB1 button closed and the command of the SB2 button effective during the closing operation.

P06.30	Digital input terminal filtering time	0.000~0.100s	0.010s	☆
P06.31	Terminal protection function	0: no protection	0	★

		When command is terminal ,power on and terminal effective,inverter will run 1: protection When command is terminal ,power on and terminal effective, inverter will not run ,so need terminal ineffective then effective,then inverter will run		
P06.32	DI terminal on/ready time	0.000s~30.000s	1.000s	★
P06.33	VDI1 source parameter	Select the source of VDI1 and select the input signal of VDI1 together with the unit of P06.17	06.00	★
P06.34	VDI2 source parameter	Select the source of VDI1 and select the input signal of VDI2 together with the unit of P06.17	06.00	★
P06.35	VDI3 source parameter	Select the source of VDI1 and select the input signal of VDI3 together with the unit of P06.17	07.00	★
P06.36	VDI4 source parameter	Select the source of VDI1 and select the input signal of VDI4 together with the unit of P06.17	44.00	★
07 Group Multi-function Digital output				
r07.00	DO output port status	Define as per bit, 0:ineffective 1:effective Bit0:DO1 Bit1:DO2 Bit2:relay1, Bit 3:relay 2 Bit4: DO3;Bit5: DO4 Bit6: DO5; Bit7: DO6 Bit8: VDO1;Bit9: VDO2	-	●
P07.01	Reserved	0:No function 1:READY 2:RUN 3:Error1 (stop fault) 4:Error2 (same as Error1 except undervoltage) 5:Warning output(fault but in running) 6:Swing frequency limit		☆
P07.02	DO2(HDO) Output terminal function group	7:Torque limit 8:Reverse running 9: Upper limit frequency arrival 10:Lower limit frequency arrival 1 11: Lower limit frequency arrival2 12:FDT1 output frequency detection range 13:FDT2 output frequency detection range	0	☆
P07.03	Relay 1 Output terminal function group(TA TB TC)	14:Setting frequency arrival 15:Desired frequency attained 1 P08.05 16:Desired frequency attained 2P08.07 17:Zero speed (stop without output) 18: Zero speed (stop with output) 19:Zero current status	3	☆

P07.09	VDO1(virtual DO1) output Terminal function	20:Output current exceed limit 21:Counter 1 setting value arrival 22:Counter 1 setting value arrival 23:Simple PLC cycle finish 24:IGBT temperature arrival 25:Drive overload pre-warning 26: Motor overload pre-warning 27: Motor overheat pre-warning 28:In off loading 29:Accumulated on power time arrival 30:Accumulated running time arrival 31:Single running time arrival 32:Variable selector unit 1 output 33:Variable selector unit 2 output 34:Variable selector unit 3 output 35:Variable selector unit 4 output 36:Logic unit 1 output 37:Logic unit 2 output 38:Logic unit 3 output 39:Logic unit 4 output 40:Delaying unit 1 output 41:Delaying unit 2 output 42: Delaying unit 3 output 43: Delaying unit 4 output 44: Delaying unit 5 output 45: Delaying unit 6 output	0	☆
P07.10	VDO2(virtual DO2) output Terminal function	20:Output current exceed limit 21:Counter 1 setting value arrival 22:Counter 1 setting value arrival 23:Simple PLC cycle finish 24:IGBT temperature arrival 25:Drive overload pre-warning 26: Motor overload pre-warning 27: Motor overheat pre-warning 28:In off loading 29:Accumulated on power time arrival 30:Accumulated running time arrival 31:Single running time arrival 32:Variable selector unit 1 output 33:Variable selector unit 2 output 34:Variable selector unit 3 output 35:Variable selector unit 4 output 36:Logic unit 1 output 37:Logic unit 2 output 38:Logic unit 3 output 39:Logic unit 4 output 40:Delaying unit 1 output 41:Delaying unit 2 output 42: Delaying unit 3 output 43: Delaying unit 4 output 44: Delaying unit 5 output 45: Delaying unit 6 output	0	☆
P07.11	Output logic negative	Define as per bit O:off;1:on(negative) Bit0:DO1 Bit1:DO2 Bit2:Relay 1 Bit3: Relay 2 Bit4: DO3;Bit5: DO4 Bit6: DO5; Bit7: DO6 Bit8: VDO1;Bit9: VDO2 Notice:positive logic equivalent to Normal open point And negative logic equivalent to Normal close point	0	☆
P07.14	DO2 effective delay time	0.000s~30.000s	0.000s	☆
P07.15	DO2 ineffective delay time	0.000s~30.000s	0.000s	☆
P07.16	Relay 1 effective delay time	0.000s~30.000s	0.000s	☆
P07.17	Relay 1 ineffective delay time	0.000s~30.000s	0.000s	☆

08Group Digital output setting				
P08.00	Frequency detection value (FDT1)	0.00Hz~maximum frequency(P01.06)	50.00Hz	☆
P08.01	Frequency detection hysteresis 1	0.0%~100.0% FDT1	5.0%	☆
P08.02	Frequency detection value 2(FDT2)	0.00Hz~maximum frequency(P01.06)	50.00Hz	☆
P08.03	Frequency detection hysteresis 2	0.0%~100.0% FDT2(P08.02)	5.0%	☆
<p>FDT is used to check inverter output frequency,when output frequency is greater than frequency detection value,FDT effective,when output frequency is less than frequency detection value*(1- Frequency detection hysteresis),FDT ineffective;whenoutput frequency is between the above two,FDT output keep no change,following is FDT chart</p>				
P08.04	Detection range of frequency arrival	0.0%~100.0% maximum frequency (P01.06) When output frequency is between command frequency $\pm P08.04 * P01.06$,corresponding DO output effective signal	3.0%	☆
P08.05	Desired frequency attained 1	0.00Hz~maximum frequency (P01.06)	50.00Hz	☆
P08.06	Any frequency reaching detection amplitude 1	0.0%~100.0% maximum frequency (P01.06)	3.0%	☆
P08.07	Desired frequency attained2	0.00Hz~maximum frequency(P01.06)	50.00Hz	☆
P08.08	Any frequency reaching detection amplitude 2	0.0%~100.0% maximum frequency (P01.06)	3.0%	☆
P08.09	Zero speed detection amplitude	0.00H~5.00Hz	0.25Hz	☆
P08.10	Zero current detection level	0.0%~100.0% rated motor current	5.0%	☆
P08.11	Zero current detection delay time	0.000~30.000s 0.000~30.000s Notice: When output currents $\leq P08.10$ and endure P08.11 time,corresponding DO output effective signal	0.100s	☆

P08.12	Output overcurrent threshold	0.0%~300.0% motor rated time	200.0%	☆
P08.13	Overcurrent detection delay time	0.000~30.000sNotice: When output current \geq P08.12 and endure P08.13 time,corresponding DOoutput effective signal	0.100s	☆
P08.16	Setting Running arrival time(Accumulative)	0~65530h	0h	☆
P08.17	Action upon Running time arrival	0:Continue to run;1:Stop	0	☆

11 Group Motor 1 Parameter				
r11.00	Motor type	0: AC asynchronous motor	0	●
P11.02	Motor rated power	0.1kW~800.0kW > when power is less than 1kw ,0.75kw set to 0.8 as per round up principle ,0.55kw motor set 0.6 > when change motor rated power,AC drive will automatically set other parameter of motor name plate and motor model parameter be careful to use	Depend	★
P11.03	Motor rated voltage	10V~2000V	Depend	★
P11.04	Motor rated current	P11.02<30kW: 0.01A P11.02>=30kW: 0.1A	Depend	★
P11.05	Motor rated frequency	1.00Hz~600.00Hz	50.00Hz	★
P11.06	Motor rated RPM	1~60000rpm	Depend	★
P11.07	Motor rated power factor	0.500~1.000	Depend	★
r11.08	Motor rated torque	Read only,0.1Nm(P11.02<30KW); 1Nm(P11.02>30KW)	-	●
r11.09	Number of motor 1 pairs of pole	Read only,It will auto calculate as per motor rated frequency and rated rotating speed	-	●
P11.10	Auto-tune/self-learning	0: no auto tuning 1: Stationary auto tuning of Asynchronous motor 2: Rotational auto tuning of Asynchronous motor	0	★
<p>1: Stationary auto tuning of Asynchronous motor</p> <p>When do auto tuning ,motor stationary ,it can get parameter P11.11 ~P11.13.</p> <p>Static self-learning can not learn all the motor parameters, so the control performance is difficult to achieve the best; if the motor nameplate information is incomplete, or the motor is not a 4-pole 50Hz GB motor, it is recommended to perform "rotation self-learning".</p> <p>In the case of limited rotation, such as limited travel, limited load (crane), limited running direction, etc., static self-learning is used.</p> <p>2: Rotatoinal auto tuning of Asynchronous motor</p> <p>When do auto tuning ,motor first stationary and rotary ,it can get parameter P11.11~P11.18, as to close loop contro,it can get P10.03 encoder direction</p> <p>When rotating self-learning, the motor will rotate forward and the speed can reach 50%~100% of the rated speed. The lighter the load during self-learning, the better the learning effect.</p> <p>note:</p> <p>Notice: it can do motor auto tune when command source is keypad</p> <p>Please self-learn when the motor is cold. Make sure the motor is at rest before learning!</p> <p>Please confirm that the motor nameplate parameters have been set before self-learning. For closed-loop control, you should also set the encoder parameters!</p> <p>After setting this parameter, press the "RUN" button on the keyboard, the self-learning will start, and the inverter will stop itself after the self-learning is completed.</p>				
P11.11	Stator resistor of	Unit:0.001Ω(P11.02<30kW)	Depend	★

	Asynchronous motor	Unit:0.01mΩ(P11.02>=30kW)		
P11.12	Rotor resistor of Asynchronous motor	Unit:0.001Ω(P11.02<30kW) Unit:0.01mΩ(P11.02>=30kW)	Depend	★
P11.13	Leakage inductance of Asynchronous motor	Unit:0.01mH(P11.02<30kW) Unit:0.001mH(P11.02>=30kW)	Depend	★
P11.14	Mutual inductance of Asynchronous motor	Unit:0.1mH(P11.02<30kW) Unit:0.01mH(P11.02>=30kW)	Depend	★
P11.15	No-load excitation current of Asynchronous motor	Unit:0.01A(P11.02<30kW) Unit:0.1A(P11.02>=30kW)	Depend	★
P11.16	Excitation saturation factor 1	At non rated-excitation status	1.100	★
P11.17	Excitation saturation factor 2	At non rated-excitation status	0.900	★
P11.18	Excitation saturation factor3	At non rated-excitation status	0.800	★

12 Group Motor 1 VF control parameter				
P12.00	VF curve	0: linear VF 1: Multi-point VF 2: VF to the 1.3 3: 1.7 power 4: 2.0 power 5: VFcomplete separation 6: VF Half separation	0	★

➤ When the VF curve is straight line and power curve, the frequency-voltage curve is as follows:

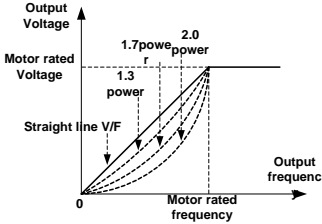

Figure 1: Straight line VF and 1.3、1.7、2.0 power VF

➤ multi-stage line type VF curve:

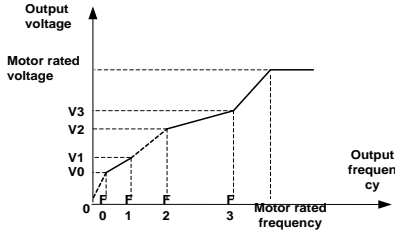

Figure 2: multi-stage line type VF curve

➤ VF full separation

The output voltage and output frequency are completely independent. The output frequency is determined by the frequency source. The output voltage is determined by P12.20. Suitable for applications such as variable frequency power or torque motors.

➤ VF semi-isolated

At this point the ratio of output voltage and output frequency given by the voltage source, the formula is as follows::

$$\text{output voltage} = 2 \times \text{Voltage source given} \times \text{output frequency} \times \frac{\text{motor rated voltage}}{\text{motor rated frequency}}$$

P12.01	Multi-point VF Frequency 1(F0)	0.00Hz ~ multi-point VF curve F1(P12.03)	0.00Hz	☆
P12.02	Multi-point VF Voltage 0(V0)	0.0% ~ 100.0%	0.0%	☆
P12.03	Multi-point VF Frequency 1(F1)	multi-point VF curve F0(P12.01) ~ multi-point VF curve F2(P12.05)	50.00Hz	☆
P12.04	Multi-point VF Voltage 1(V1)	0.0% ~ 100.0%	100.0%	☆
P12.05	Multi-point VF Frequency	multi-point VF curve F1(P12.03) ~ multi-point	50.00Hz	☆

	1(F2)	VF curve F3(P12.08)		
P12.06	Multi-point VF Voltage 2(V2)	0.0%~100.0%	100.0%	☆
P12.07	Multi-point VF Frequency 3(F3)	multi-point VF curveF2(P12.05)~600.00Hz	50.00Hz	☆
P12.08	Multi-point VFFvoltage 3(V3)	0.0%~100.0%	100.0%	☆
P12.09	Torque boost	0%~200% 0% is automatic torque boost	0%	☆
<p>➤ Automatic torque boost When P12.09=0=Automatic torque boost,inverter will automatically compensate output voltage to improve torque in low frequency as per actual load ,it is useful for linear VF curve</p> <p>➤ Manual torque boost ➤ When P12.09 not 0,it means manual torque output.Output frequency 0 torque increasing value=p12.09*motor stator resistance *rated excitation current.,increasing value will be gradually decreased as frequency increase ,if higher than 50% of motor rated frequency,increasing value will be zero</p> <p>➤ Notice>manual torque boost is useful to linear and power curve</p>				
P12.11	Slip compensation gain	0~200% It is used to compensate the speed drop of the asynchronous motor VF control with load, and improve the speed control accuracy. Please adjust according to the following principles: <ul style="list-style-type: none"> ● Increase the setting when the motor speed is lower than the target value with loading. ● Reduce this setting when the motor speed is higher than the target value with loading, 	100%	☆
P12.12	Slip compensation filter time	0.01s~10.00s It is used to adjust the speed and stability of the VF control response to the load. <ul style="list-style-type: none"> ● Decrease this setting when the load response is slow. ● Increase this setting when the speed is unstable 	1.00s	☆
P12.13	Oscillation suppression gains	0~2000	300	☆
P12.14	Oscillation suppression effective frequency range	Oscillation suppression effective range :100%~1200% Set the range of the oscillation suppression function, 100% corresponds to the rated frequency of the motor	110%	☆
P12.15	Current limit function selection	0: ineffective 1: only adjust output voltage 2: adjust output frequency	2	★
P12.16	Current limit level	20%~180% drive rated current	150%	☆
P12.17	Weak magnetic zone current limit factor	optimize dynamic performance of Weak magnetic zone,10%~100%	0.60	☆

P12.20	Voltage source for VF separation	0: digital setting 1: AI1 2: AI2 3: Reserved 4: Reserved 5: pulse setting HDI 6: Reserved 7: communication 8: PID 9: Potentiometer	0	★
P12.21	Digital setting for VF separation voltage	0.0%~100.0%	0.0%	☆
P12.22	VF separation voltage Accel and Decel time	0.00s~60.00s	1.00s	☆
P12.23	VF Separation voltage rates as per time	VF Separation Voltage variation every hour range:-100.00%~100.00%	0.0%	☆

13 Group Motor 1 vector control				
P13.00	Speed Proportional Gain ASR_P1	0.1~100.0	12.0	☆
P13.01	Speed Integral Time constant ASR_T1	0.001s~30.000s	0.100s	☆
P13.02	Speed Proportional Gain ASR_P2	0.1~100.0	8.0	☆
P13.03	Speed Integral Time constant ASR_T1	0.001s~30.000s	0.300s	☆
P13.04	ASR parameter Switching frequency 1	0.00Hz~ ASR switching frequency 2(P13.05)	5.00Hz	☆
P13.05	ASR parameter Switching frequency 2	ASR switching frequency 1~600.00Hz(P13.04)	10.00Hz	☆
<p>P13.00 and P13.01 are Speed adjuster parameter for low-speed use,scope of action from zero to P13.04 P13.02 and P13.03 are Speed adjuster parameter for high-speed use,scope of action from P13.05 to maximum frequency P13.04-P13.05 Two sets of parameter for linear tansitions</p>				
P13.06	Speed control torque limit source selection	Unit's digit: Electric torque limit source 0:digital setting 1: Ai1 2: Ai2 3-4(option card) 5:Pulse HDI 6:Communication 7:Potentiometer Ten'unit: Electric torque limit source Same as unit'digit	00	★
P13.07	Electric torque limit	0.0%~300.0%	160.0%	☆
P13.08	Upper limit of brake torque	0.0%~300.0%	160.0%	☆
P13.12	Torque current directives filter time	Unit: current loop adjust cycle ,0~100	2	☆
P13.13	ACR Proportional Gain1	0.01~10.00 ACR:automatic current regulator	0.4	☆
P13.14	ACR Integral Time1	0.01~300.00ms	10.00ms	☆
P13.15	ACR Proportional Gain2	1~1000 ACR:automatic current regulator	0.4	☆
P13.16	ACR Integral Time2	0.01~300.00ms	10.00ms	☆
P13.17	Voltage feedforward Gain	0~100improve the dynamic response of vector control,	0	★
P13.19	Voltage margin	0.0%~50.0%improve the dynamic response of weak magnetic curvature.	5.0%	☆
P13.20	Flux weakening adjuster integral time	0.001s-5.000s	0.100s	☆
P13.22	Slip compensation	50%-200%	100%	☆
P13.23	SVC zero speed directives	0:no action 1:output DC current	0	★

ACR means:automatic current regulator and ASR means :automatic speed regulator

14 Group Torque control				
P14.00	Torque setting	0: digital setting 1: AI1 2: AI2 3: AI3(reserved) 4: AI4(reserved) 5: HDI 6: Communication 7: Potentiometer	0	★
P14.01	Torque digital setting	-200.0~200.0%	0	☆
P14.02	Maximum torque	Benchmark 10.0%~300.0% Notice:torque benchmarks for analog inputs and high frequency pulse input as well as limit output torque in torque control	200.0%	★
P14.03	Torque Acceleration time	0.000s~60.000s Notice:Torque given time from zero to motor rated torque	0.100s	☆
P14.04	Torque control Deceleration time	0.000s~60.000s Notice:Torque given time from motor rated torque to zero	0.100s	☆
P14.05	Upper limit frequency of torque control	0: digital setting 1: AI1 2: AI2 3: AI3(expansion card) 4: AI4 (expansion card) 5: HDI high frequency pulse input 6: communication	0	★
P14.06	Upper limit frequency of torque control	-100.0%~100.0%	100.0%	☆
P14.07	Reverse speed limit	Relative to maximum frequency: 0.0%~100.0% Notice:Speed limit for reverse speed direction not specified by the speed limit source	40.0%	☆
P14.08	Torque setting over limit speed	0: match torque setting 1: speed control	0	★
P14.10	Static friction torque	0.0%~50.0%	10.0%	☆
P14.11	Static friction torque compensation	0.00Hz~50.00Hz	1.00Hz	★
P14.12	Dynamic friction factor	0.0%~50.0% Dynamic friction at rated speed Notice: motor sliding friction torque at rated rotating speed	0.0%	☆
P14.13	Dynamic friction starting value	0.0%~50.0%	0.0%	☆

16 Group Energy saving control parameter				
r16.00	Electricity meter count (32BIT)	Unit:KW/H	-	●
r16.02	Output power	Unit:0.1kw,output power will be negative in regen state	-	●
r16.03	Power factor	-1.000~1.000	-	●
P16.04	Electricity meter zero clearing	0:no function; 1111: clear to zero	0	☆
P16.05	Energy saving control	0: disable 1: enable	0	★
P16.06	Energy saving voltage limit	0%~50%	0%	☆
P16.07	Energy saving filter time	0.0~10.0s	2.0s	☆

Notice:When energy saving enabled, the output current can be reduced and the power loss can be reduced when the load is light. For example, the fan and pump is light loaded, most of the inverters do not have this function, so we are more energy efficient. Energy savings can be achieved when it is light loads or load changes so slow

20 Group User-defined function code menu				
P20.00	User-defined function code 1		00.00	☆
P20.01	User-defined function code 2		00.00	☆
P20.02	User-defined function code 3		00.00	☆
P20.03	User-defined function code 4		00.00	☆
P20.04	User-defined function code 5		00.00	☆
P20.05	User-defined function code 6		00.00	☆
P20.06	User-defined function code 7		00.00	☆
P20.07	User-defined function code 8		00.00	☆
P20.08	User-defined function code 9	<p>The value is the function code number, ranging from 00.00 to 63.99.</p> <p>Example: If you want to display P03.01 and P13.00 in the user-defined menu mode (-USR-), set P20.00=03.01, P20.01=13.00</p>	00.00	☆
P20.09	User-defined function code 10		00.00	☆
P20.10	User-defined function code 11		00.00	☆
P20.11	User-defined function code 12		00.00	☆
P20.12	User-defined function code 13		00.00	☆
P20.13	User-defined function code 14		00.00	☆
P20.14	User-defined function code 1		00.00	☆
P20.15	User-defined function code 15		00.00	☆
P20.16	User-defined function code 16		00.00	☆
P20.17	User-defined function code 17		00.00	☆
P20.18	User-defined function code 18		00.00	☆
P20.19	User-defined function code 19		00.00	☆

21 Group Keypad and Display Group				
P21.00	Keyboard UP/DOWN function selection	Units: UP/DOWN enable selection 0: Disable 1: Enable Ten's unit: clear selection 0: Cleared in non-operational state 1: Not cleared Hundred's unit: Power-down memory selection 0: no memory 1: memory Thousand's unit: rate selection 0: automatic rate 1: P01.39 rate	0110	★
P21.02	MKfunction option	0: no function; 1: Forward Jog 2: Reverse Jog; 3: Forward/reverse Switch 4: Quick stop; 5: coast to stop 6: Course left shift(LCD keypad)	1	★
P21.03	STOP function	0:Valid only at Keypad Control 1:valid at all command Channels	1	☆
P21.04	Monitoring display1	00.00~99.99	27.00	☆
P21.05	Monitoring display2	00.00~99.99	27.01	☆
P21.06	Monitoring display3	00.00~99.99	27.06	☆
P21.07	Monitoring display4	00.00~99.99	27.05	☆
P21.08	Monitoring display5	00.00~99.99	27.03	☆
P21.09	Monitoring display6	00.00~99.99	27.08	☆
P21.10	Monitoring display7	00.00~99.99	06.00	☆
P21.11	Running status Monitoring display parameter option	Unit'digit to Thousand'digit set 1-4 monitor parameter 0 means no display, 1~7 corresponds to monitor parameter 1~7 Unit'digit: choose first monitoring data, 0~7 Ten's digit: choose second monitoring data, 0~7 Hundred's digit: choose third monitoring data, 0~7 Thousand's digit: choose fourth monitoring display, 0~7	5321	☆
P21.12	Stop status Monitoring display parameter option	Same as P21.11	0052	☆
<p>VFD500M digital keyboard monitoring interface supports up to 4 monitoring volume. Monitoring variables in running status and monitoring variables in stop status are set by P21.11 and P21.12, respectively. Press 【SHIFT】 key on the keyboard to switch the monitoring volume from low to high of P21.11 or P21.12, Encountered "0" then skip, cycle monitoring.</p> <p>Take the shutdown monitoring interface for example, P21.12 = 0052, there are 2 monitoring variables, which are r27.01 (monitor display parameter 2, P21.05 = 27.01) and r27.03 (monitor display parameter 5, P21.08 =</p>				

27.03), press the 【SHIFT】 key on the keyboard to switch between the two monitors, as shown below.

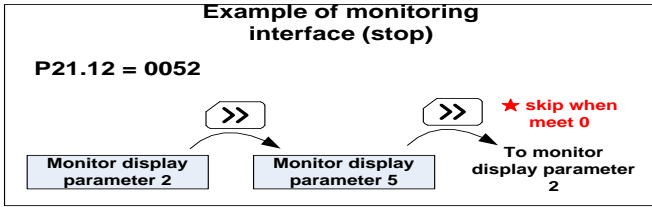

The rules for running the monitoring interface are the same as the shutdown monitoring interface, and will not be repeated

P21.13	Digital keypad personalized setting	<p>Unit's digit: quick editing function selection 0: invalid 1: Numeric frequency setting 2: Numeric torque setting 3: PID digital setting 0 Note: The quick editing function means that if the current monitoring value is the output frequency or command frequency under the monitoring status, press the [ENTER] key to enter the parameter editing interface directly. The edited parameters are set by the ones digit of this function code.</p> <p>Ten's digit: monitor pointer reset selection 0: When the display status is in the monitoring status from other status, or when the running monitoring status and stop monitoring status are switched, the previously recorded monitoring pointer position will be restored. 1: When the display status is in the monitoring status by other status, or when the monitoring status of running status and stop status are switched, the monitor pointer will be reset to the ones of P21.11 or P21.12.</p> <p>Note: when power-on, the shutdown monitoring pointer points to the P21.12 bits, the operation monitoring pointer points to P21.11 bits</p>	01	★
P21.14	Load speed display factor	0.001 ~ 65.000	30.000	☆
P21.15	Load speed decimal point digit	0 ~ 3	0	☆
r21.16	Load speed display	Load speed = P27.00 * P21.10 Decimal point digit defined by P21.11	-	●
P21.17	Speed display unit	0: 0.01Hz; 1: 1Rpm 2: 0.1hz 3: 10RPM > It is used to select the display unit of P00.07, r27.00, r27.01, r10.12. When it show RPM unit, HZ light on keypad will flash	0	★

P21.19	Keyboard potentiometer filter time	0.000s~10.000s	0.100s	☆
r21.20	Keyboard potentiometer actual value	0.00V~10.00V Used to view the port voltage of AI2. When AI2 is a current type (0~20mA) input, multiplying this value by 2 is the input current (mA) of the AI2 port.	-	●
r21.21	Keyboard potentiometer conversion value	-100.0% to 100.0% Used to view the output of the AI2 mapped curve.	-	●
P21.22	The horizontal axis 1 of the potentiometer curve	0.00V~P04.41	0.00V	☆
P21.23	The vertical axis 1 of the potentiometer curve	-100.0%~100.0%	0.0%	☆
P21.24	The horizontal axis 2 of the potentiometer curve	P04.39~P04.43	3.00V	☆
P21.25	The vertical axis 2 of the potentiometer curve	-100.0%~100.0%	30.0%	☆
P21.26	The horizontal axis 3 of the potentiometer curve	P04.41~P04.45	6.00V	☆
P21.27	The vertical axis 3 of the potentiometer curve	-100.0%~100.0%	60.0%	☆
P21.28	The horizontal axis 4 of the potentiometer curve	P04.43~10.00V	9.90V	☆
P21.29	The vertical axis 4 of the potentiometer curve	-100.0%~100.0%	100.0%	☆

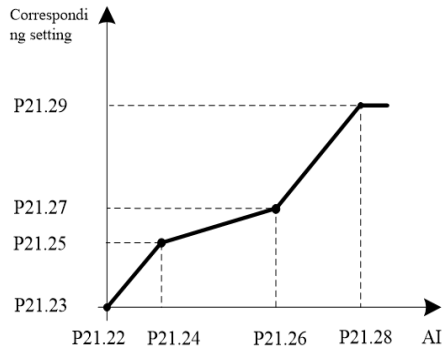

22 Group AC drive data and configuration				
P22.00	Carrier/switching frequency	<p>Depend on drives power</p> <p>≤7.5kW: 1kHz~12.0kHz</p> <p>11kW~45kW: 1kHz~8kHz</p> <p>≥55kw: 1kHz~4kHz</p> <p>The carrier frequency can be reduced when it came like following phenomenon:</p> <p>1 The leakage current generated by the inverter is large</p> <p>2 The interference generated by the inverter has an impact on peripheral devices</p> <p>3 Long wiring distance between inverter and motor</p> <p>The carrier frequency can be increased whenwhen it came like following phenomenon:</p> <p>1 The electromagnetic noise generated by the motor is large</p>	Depend	☆
P22.01	Carrier frequency adjustment	<p>Unit'digit: adjustment as per Rotation</p> <p>0:No; 1:Yes</p> <p>Ten'digit: adjustment as per Temperature</p> <p>0 no: 1: yes</p>	00	★
P22.02	Low speed carrier frequency	1.0kHz~15.0kHz	Depend	☆
P22.03	High speed carrier frequency	1.0kHz~15.0kHz	Depend	☆
P22.04	Carrier frequency switching point 1	0.00Hz~600.00HzWhen the carrier frequency is adjusted according to the output frequency, the carrier frequency set by P22.02 is used when the output frequency is lower than this set value.	7.00Hz	☆
P22.05	Carrier frequency switching point2	0.00Hz~600.00Hz When the carrier frequency is adjusted according to the output frequency, the carrier frequency set by P22.03 is used when the output frequency is higher than this set value.	50.00Hz	☆
P22.06	PWM way	<p>0: SVPWM</p> <p>It is normally used</p> <p>1: SVPWM+DPWM</p> <p>Using this modulation method can reduce the switching loss of the inverter and reduce the probability of overheating alarm of the inverter; however, the electromagnetic noise of the motor in the medium speed section will be too large.</p> <p>2: PWM at random</p> <p>The electromagnetic noise generated by the motor is white noise, not a sharp squeak.</p> <p>3: SPWM</p>	0	★

		It is only used in special situation		
P22.07	DPWM switching point	10%~100%(modulation percentage) When P22.06 is set to 1, increasing this setting value can reduce the electromagnetic noise in the middle speed section.	30%	★
P22.08	Modulating limit	50%~110% It is used to define the duty cycle of the inverter side IGBT. Overmodulation is allowed when it is set to 100% or more, and the allowable overmodulation is deepened when the set value is increased from 101 to 110.	105%	★
P22.10	AVR function	0:disabled 1:enabled When the AVR function is enabled, the effect of the DC bus voltage change on the output voltage can be eliminated.	1	★
P22.11	Energy braking voltage function	0-disabled 1-enabled 2-only enable when ramp to stop This parameter is only used to control the built-in brake unit. For models without a built-in brake unit, this setting can be ignored.	1	☆
P22.12	Energy braking voltage	320V~400V(220V level) 600V~800V(380V level) 690V~900V(480V level)	Depend	☆
P22.13	Output phase switch	0:no Operation 1:output phase switch (equal to change Phase between V and W,For closed loop control, you need to re-rotate the self-learning to confirm the encoder direction)	0	★
P22.14	Cooling method (fan control)	0:effective when running 1:Forced control(effective when power on) 2:adjustable as per drive temperature	0	☆
P22.15	G/P drive type	0-G type;1-P type ➤ G means normal duty (constant torque load) ➤ P means light duty such as fan and pump	0	★
r22.16	Drive rated power	Read only Unit:0.1kw	-	●
r22.17	Drive rated Voltage	Read only Unit:V	-	●
r22.18	Drive rated current	Read only Unit:0.1A	-	●

23 Group Drive protection function setting				
P23.00	DC Bus voltage control option	<ul style="list-style-type: none"> ➤ Unit'digit :Overvoltage stall control 0:overvoltage stall disabled 1:overvoltage stall enabled 2:overvoltage stall enabled self-adjustable ➤ The over-voltage stall function limits the amount of power generated by the motor by extending the deceleration time or even increasing the speed, avoiding over-voltage on the DC side and reporting over-voltage faults Ten'unit:Undervoltage stall control 0:undervoltage stall disabled 1:Undervoltage stall(decelerate to zero speed and be in standby mode,after power restoring ,it will run again automatically) 2: Undervoltage stall deceleration(decelerate to zero and stop) ➤ The undervoltage stall function reduces the motor power consumption or reduces the power consumption of the motor or turns it into a power generation operation to avoid the undervoltage fault on the DC side. ➤ The undervoltage stall function is used when the input power supply quality is poor (the power supply voltage fluctuates downward or the sporadic short power is suspended), and it is necessary to keep the inverter running as much as possible. 	01	★
P23.01	Overvoltage stall threshold	220V Level: 320V~400V 380V Level: 540V~800V 480V Level: 650V~950V	Depend	★
P23.02	Undervoltage threshold	220V level: 160V~300V 380V level: 350V~520V 480V level: 400V~650V	Depend	★
P23.03	Overvoltage stall ratio	0~10.0	1.0	☆
P23.04	Undervoltage stall ratio	0~20.0	4.0	☆
P23.05	Undervoltage trip threshold	220V Level:160V~300V 380V Level:350V~520V 480V Level:400V~650V	Depend	★
P23.06	Undervoltage fault detecting time	0.0s~30.0s	1.0s	☆
P23.07	Rapidcurrent limit	0:Disabled 1:Enabled	1	★
P23.10	Over-speed detection value	0.0%~120.0% maximum frequency	120.0%	☆
P23.11	Over-speed detection time	0.0s~30.0s0.: shielding	1.0s	☆

P23.12	Detection value of too large speed deviation	0.0%~100.0%(motor rated frequency)	20.0%	☆
P23.13	Detection value of too large speed deviation	0.0s~30.0s 0.0: shielding	0.0s	☆
P23.14	Input phase loss detection time	0.0s~30.0s 0.0: forbidden	8.0s	☆
P23.15	Output phase loss inbalance detecting	0%~100%	30%	☆
P23.18	Fault protection action selection 1	Unit's digit : input phase loss 0: coast to stop 1: Emergent stop 2: Stop as per stop mode 3: continue to Run Ten'unit: user self-defined fault 1 same as Unit's digit Hundred'unit: user self-defined fault 2 same as Unit'digit Thousand's unit: communication fault same as unit's digit	0000	☆
P23.19	Fault protection action selection 2	Unit's digit: motor overload 0: coast to stop 1: emergent stop 2: stop as per stop mode 3: continue to run Ten'unit: motor overheat same as unit'digit Hundred'unit: too large speed deviation same as unit'digit Thousand's unit: motor over speed same as Unit'digit	0000	☆
P23.20	Fault protection action selection 3	Unit's digit: PID feedback lost during running 0: coast to stop 1: fast stop 2: stop as per stop mode 3: continue to run Ten'unit: Reserved same as unit'digit Hundred'unit: reserved same as unit'digit thousand'unit: reserved same as unit'digit	0000	☆
P23.21	Fault protection action selection 4	Unit's digit: output phase loss 0: coast to stop 1: fast stop 2: stop as per stop mode Ten'unit: EEPROM fault 0: coast to stop	0000	☆

		1: fast stop 2: stop as per stop mode 3: continue to run Hundred's unit: PG card fault(reserved) 0: coast to stop 1: fast stop 2: stop as per stop mode 3: continue to run Thousand's unit: off load fault 0: coast to stop 1: fast stop 2: stop as per stop mode 3: continue to run		
P23.24	Fault reset	Define as per bit: bit0-undervoltage;bit1- inverter overload bit2-inverter overheat ;bit3-motor overload bit4-motor overheat;bit5-user'fault 1 bit6- user'fault 2; bit7~15 reserved	0	☆
P23.25	Fault source for auto reset	Define as per bit: bit0-overcurrent during acceleration;bit1- overcurrent during deceleration bit2-overcurrent during constant speed;bit3-over voltage during acceleration bit4-overvoltage during deceleratoin;bit5- overvoltage during bit6-inverter undervoltage;bit7-input phase loss bit8-inverter overload;bit9-inverter overheat bit10-motor overload;bit11-motor overheat bit12-user'fault 1;bit13-user'fault 2 bit14-Reserved;bit15-Reserved	0	☆
P23.26	Fault auto Reset times	0~99	0	☆
P23.27	Numeric output Action at fault reset	0:disabled 1:enabled	0	☆
P23.28	Interval time of fault auto reset	0.1s~300.0s	0.5s	☆
P23.29	Fault auto reset times clearing time	0.1s~3600.0s	10.0s	☆
P23.30	Continuing Running frequency selection when trip	0: run at current frequency 1: run at setted frequency 2: run at upper limite frequency 3: run at lower limit frequency 4: run at abnormal back-up frequency	0	☆
P23.31	Abnormal back-up frequency	0.0%~100.0%(maximum frequency)	5.0%	☆

24 Group motor Protection parameter				
P24.00	Motor overload protection gain	0.20~10.00	1.00	☆
P24.01	Motor overload starting current at zero speed	50.0%~150.0%	100.0%	☆
P24.02	Motor overload starting current at Rated speed	50.0%~150.0%	115.0%	☆

Motor in self cooling mode, heat dissipation is poor when in low frequency but good in condition of high frequency . P24.01 and P24.02 is used to set the starting point of zero and rated speed overload current in order to obtain a more reasonable under different speed overload protection Time curve

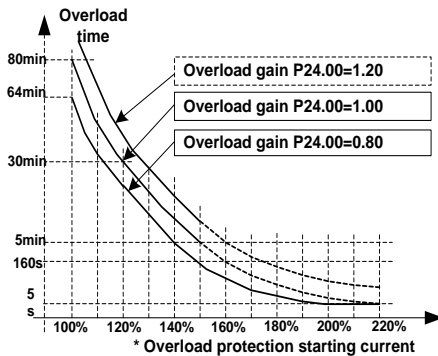
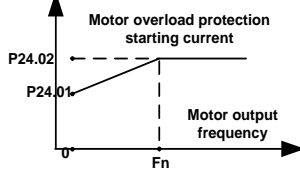

Left: Motor overload protection starting current

Right: Motor Overload Protection Curve with Different Overload Protection Gains

Motor overload Overload protection of motor 2 only when P24.04 bits equals one or overload protection of motor 1 or P24.08 bits equals one. P24.00 is used to adjust the overload inverse time curve time, as shown in the right figure above, the minimum motor overload time is 5.0s.

Note: Users need to correctly set the three parameters of P24.00, P24.01 and P24.02 according to the actual overload capacity of the motor. If set unreasonable, prone to motor overheating damage and the inverter is not timely warning of the danger of protection.

P24.04	Motor 1 protection option	Units: Motor 1 overload protection selection 0: Turn off software overload protection 1: Enable software overload protection Ten's unit: Motor 2 overload protection selection 0: Turn off software overload protection	11	☆
--------	---------------------------	---	----	---

		1: Enable software overload protection		
P24.12	Off load protection	0:effective 1:ineffective	0	☆
P24.13	Off load detection level	0.0%-100%	10.0%	☆
P24.14	Off load detection time	0.000s-60.000s	1.000s	☆

Off load=unload

If output current is lower than offload detection level (P24.13) and this status continues for offload detection time (P24.14) when offload detection protection is enabled (P24.12=1)

and inverter is in running mode and not in DC brake, then inverter gives an offload protection fault (Er. LL) report and stops as the offload protection setting (P24.12)

25 Group Fault tracking parameter				
r25.00	Current fault type	- see detail chapter 6 fault diagnosis and solution	-	●
r25.01	Output frequency at fault	Unit:0.01Hz	-	●
r25.02	Output current at fault	Unit:0.1A	-	●
r25.03	Bus voltage at fault	Unit:V	-	●
r25.04	Running mode status 1 at fault	- see Parameter r27.10 in detail	-	●
r25.05	Input terminal status at fault	Bit0~Bit6 corresponds to DI1~DI7 Bit12~Bit15 corresponds to VDI1~VDI4	-	●
r25.06	Working time at fault	Unit:0.01S	-	●
r25.07	Accumulated working time at fault	Unit:hour	-	●
r25.08	Frequency source at fault	Unit:0.01hz	-	●
r25.09	Torque source at fault	Unit:0.1% compared to motor rated torque	-	●
r25.10	Encoder speed at fault	Unit:RPM	-	●
r25.11	Electrical angle at fault	Unit: 0.1°	-	●
r25.12	Running mode status 2 1at fault	See Parameter r27.11 in detail	-	●
r25.13	Input terminal status at fault	Define as per unit, 0:ineffective, 1:effective Bit0: DO1; Bit1: DO2 Bit2: relay; Bit3~Bit7: reserved; Bit8: VDO1; Bit9: VDO2	-	●
r25.14	Heat sink temperature at fault	Unit: 0.1° C	-	●
r25.15	Low-level fault	-	-	●
26 Group Fault recording parameter				
r26.00	Last fault 1trip type	SEE DETAILS IN CHAPTER 6	-	●
r26.01	Output frequency at fault	Unit:0.01Hz	-	●
r26.02	Output current at fault	Unit:0.1A	-	●
r26.03	Bus voltage at	Unit:V	-	●

	fault				
r26.04	Running mode status 1at fault	See Parameter r27.10	-	●	
r26.05	Input terminal status at fault	Bit0~Bit6 corresponds to DI1~DI7 Bit12~Bit15 corresponds to VDI1~VDI4	-	●	
r26.06	working time at fault	Unit:0.01S	-	●	
r26.07	Accumulated working time atfault	Unit:hour	-	●	
r26.08	Last fault 2 trip type	Same as last fault description	-	●	
r26.09	Output frequency at fault		-	●	
r26.10	Output current at fault		-	●	
r26.11	Bus voltage at fault		-	●	
r26.12	Running mode status 1at fault		-	●	
r26.13	Input terminal status at fault		-	●	
r26.14	working time at fault		-	●	
r26.15	Accumulated working time at fault		-	●	
r26.16	Last fault 3 trip type		Same as last fault description	-	●
r26.17	Output frequency at fault			-	●
r26.18	Output current at fault	-		●	
r26.19	Bus voltage at fault	-		●	
r26.20	Running mode status 1at fault	-		●	
r26.21	Input terminal status at fault	-		●	
r26.22	working time at fault	-		●	
r26.23	Accumulated working time atfault	-		●	

27 Group Monitoring parameter				
r27.00	Running frequency	It can set unit as per Parameter P21.07	-	●
r27.01	Set frequency	It can set unit as per Parameter P21.07	-	●
r27.02	Direction indicator	bit0: direction of running frequency bit1: direction of setting frequency bit2: direction of main frequency bit3: direction of auxiliary frequency bit4: direction of UpDown offset bit5: reserved	-	●
r27.03	Bus voltage	Unit: 1V	-	●
r27.04	VF separation setting	unit: 0.1%	-	●
r27.05	Output voltage	unit: 0.1V	-	●
r27.06	Output current	unit: 0.1A	-	●
r27.07	Output current percentage	unit: 0.1%(100% of motor rated current)	-	●
r27.08	Output torque	0.1%	-	●
r27.09	Torque setting	0.1%	-	●
r27.10	Drives running mode status 1	Bit0:Running status 0-Stop;1-Run Bit1:Motor direction0-Forward;1-Reverse Bit2:Ready signal:0-not ready;1-ready Bit3:fault status 0-no fault;1-fault Bit4~5:fault type:0-free stop;1-fast stop;2-stop as per stop mode; 3: continue to run Bit6:jog status:0-no jog;1-jog status Bit7:Auto tune :0-no;1-yes Bit8:DC braking:0-Non DC braking;1-DC braking Bit9:Reserved Bit10~11:Acceleration and Deceleration: 0:stop/zero output;1:speed up;2:slow down;3:constant speed Bit12:reserved Bit13:current limit status:0-no;1-yes Bit14:overvoltage stalladjustment:0-no ;1-yes Bit15:undervoltage stall adjustment :0-no;1-yes	-	●
r27.11	Drives running mode2	Bit0~1:current command source:0-keypad;1-terminal ;2-communicatoin Bit2~3:motor option:0-motor 1;1-motor 2 Bit4~5:current motor control:0-VF;1-SVC;2-VC Bit6~7:current running mode:0-speed;1-torque;2-position	-	●

r27.14	Accumulated power on time	Unit:hour	-	●
r27.15	Accumulated running time	Unit:hour	-	●
r27.18	Heat sink temperature	Unit:0.1 ℃	-	●
r27.19	Main frequency	Unit:0.01Hz	-	●
r27.20	Auxiliary frequency	unit:0.01Hz	-	●
r27.21	UpDown offset frequency	unit:0.01Hz	-	●
30 Group Modbus communication parameter				
P30.00	Communication type	0:Modbus; 1~2: reserved	0	★
P30.01	Drive Address	1~247 Different slaves on the same network should set different local addresses; 0 is the broadcast address, all slave inverters can be identified	1	★
P30.02	Modbus baud rate	0:1200 bps; 1:2400 bps 2:4800 bps; 3:9600 bps 4:19200 bps; 5:38400 bps 6:57600 bps; 7:115200 bps	3	★
P30.03	Modbus data format	0: 1-8-N-1 (1 start bit +8 data bits +1 stop bits) 1: 1-8-E-1 (1start bit +8 data bits +1 even parity +1 stop bit) 2: 1-8-0-1 (1 star bit+8 data bits +1odd parity+1 stop bits) 3: 1-8-N-2 (1 star bit+8 data bits+2 stop bits) 4: 1-8-E-2 (1 star bits+8 data bit+1 even parity+2 stop bits) 5: 1-8-0-2 (1 start bit +8 data bits+1 odd parity+2 stop bits)	0	★
P30.04	Modbus response delay	1~20msThe delay time of the local to answer the master	2ms	★
P30.05	Modbus overtime	0.0s(disabled)~60.0s(works for master-slave system) When this function code effective,if slave do not receive data from master overtime,it will trip as Er.485	0.0s	★
r30.06	Number of process	Add 1 after receive one data, 0~65535	-	●

	data received	count in cycle		
r30.07	Number of process data transmission	Add 1 after transmiss one data , 0~65536 count in cycle	-	●
r30.08	Number of error frames received by Modbus	Each time an CRC error frame is received, this value is incremented by 1,0 to 65535 cycles; it can be used to judge the degree of communication interference.	-	●
P30.09	Modbus master-slave option	0: slave 1: master(sent by broadcast)	0	★
P30.10	Slave memory when inverter as master	1~9 corresponds to 0x7001~0x7009	1	☆
P30.11	Data sent by Master	0:output frequency 1:set frequency 2:output torque 3:set torque 4:PID setting 5:PID feedback 6:output current	0	☆
P30.12	Sending interval of Master	0.010~10.000sAs a master, after sending one frame of data, the next frame of data is sent after this delay.	0.1s	☆
P30.13	Receiving propoartaionality factor of slave	-10.000~10.000The values of slave registers 0x7001 and 0x7002 take effect after passing through this scaling factor	1.00	☆
P30.14	Communication special register speed unit	0: 0.01% 1: 0.01Hz 2: 1Rpm Some units of specific communication registers can be set by this parameter. See Appendix A for details.	0	☆
P30.15	Modbus response characteristics	When the format of the received frame is a write register, this parameter can be set to reply to the host. 0: Reply to the host (standard Modbus protocol) 1: Do not reply to the host (non-standard Modbus protocol)	0	☆

40 Group PID function				
r40.00	PID final output value	Read only unit:0.1%	-	●
r40.01	PID final set value	Read only unit:0.1%	-	●
r40.02	PID final feedback value	Read only unit:0.1%	-	●
r40.03	PID deviation value	Read only unit:0.1%	-	●
<p>PID through the target signal (command) and the controlled amount of the difference between the feedback signal proportional (P), integral (I) and differential (D) operation, adjust the inverter output frequency, etc., to achieve closed-loop system, the controlled amount Stable at the target value.</p> <p>VFD500M built-in process PID structure as shown below, suitable for flow control, pressure control, temperature control and tension control applications.</p>				
P40.04	PID reference source	Unit's digit:PID main reference source(ref1) 0: Digital setting 1: AI1 2: AI2 3: AI3(option card) 4: AI4(option card) 5: HDI high frequency pulse 6: communication 7: Potentiometer Ten's digit:PID Auxiliary reference source(ref2)Same as Unit's digit	00	☆
P40.05	PID given feedback range	0.01~655.35	100	☆
P40.06	PID preset setting 0	0.0~P40.05	0.0%	☆
P40.07	PID preset setting 1	0.0~P40.05	0.0%	☆
P40.08	PID preset setting 2	0.0~P40.05	0.0%	☆

P40.09	PID preset setting 3	0.0~P40.05	0.0%	☆															
When PID reference source is digital setting, PID digital setting 0~3 depends on DI terminal function 43 (preset PID terminal 1) and 44 (preset PID terminal 2):																			
<table border="1"> <thead> <tr> <th>preset PID terminal1</th> <th>preset PID terminal 2</th> <th>PID Digital setting value(0.1%)</th> </tr> </thead> <tbody> <tr> <td>0</td> <td>0</td> <td>P40.06 * 100.0% / P40.05</td> </tr> <tr> <td>1</td> <td>0</td> <td>P40.07 * 100.0% / P40.05</td> </tr> <tr> <td>0</td> <td>1</td> <td>P40.08 * 100.0% / P40.05</td> </tr> <tr> <td>1</td> <td>1</td> <td>P40.09 * 100.0% / P40.05</td> </tr> </tbody> </table>					preset PID terminal1	preset PID terminal 2	PID Digital setting value(0.1%)	0	0	P40.06 * 100.0% / P40.05	1	0	P40.07 * 100.0% / P40.05	0	1	P40.08 * 100.0% / P40.05	1	1	P40.09 * 100.0% / P40.05
preset PID terminal1	preset PID terminal 2	PID Digital setting value(0.1%)																	
0	0	P40.06 * 100.0% / P40.05																	
1	0	P40.07 * 100.0% / P40.05																	
0	1	P40.08 * 100.0% / P40.05																	
1	1	P40.09 * 100.0% / P40.05																	
For example: When AI1 is used as PID feedback, if the full range corresponds to 16.0Kg pressure and require PID control to be 8.0Kg; then set P40.05 PID feedback range to 16.00, PID digital reference terminal select to P40.06, Set P40.06 (PID preset setting 0) to be 8.00																			
P40.10	PID reference source selection	0:ref1 1:ref1+ref2 2:ref1-ref2 3:ref1*ref2 4:ref1/ref2 5:Min(ref1,ref2) 6:Max(ref1,ref2) 7:(ref1+ref2)/2 8: ref1 and ref2 conversion 9: Reserved 10:Reserved 11:Reserved 12: Reserved Sqrtmeans square root calculation, eg:sqrt(50.0%)= 70.7%	0	☆															
P40.11	PID feedback source1	Unit's digit 0: PID feedback source1(fdb1) 0:AI1 1:AI2 2:AI3(option card) 3:AI4(option card) 4: PLUSE(HDI) 5: Communication 6: Motor rated output current 7: Motor rated output frequency 8: Motor rated output torque 9: Motor rated output frequency Ten's digit : PID feedback source2 (fdb2) Same as Unit's digit	00	☆															
P40.13	PID feedback function selection	0:fdb1 1:fdb1+fdb2 2:fdb1-fdb2 3:fdb1*fdb2 4:fdb1/fdb2 5:Min(fdb1,fdb2)Take fdb1.fdb2 smaller	0	☆															

		value 6:Max(fdb1,fdb2) Take fdb1.fdb2 bigger value 7: (ref1+ref2)/2 8: ref1 and ref2 conversion 9: Reserved 10:Reserved 11:Reserved 12: Reserved Sqrt means square root calculation, eg:sqrt(50.0%)=70.7%		
P40.14	PID output feature	0-positive 1-negative	0	☆
<p style="text-align: center;">The PID output characteristic is determined by P40.14 and DI terminal 42 function PID positive/negative switching:</p> <p>P40.14 = 0 and PID positive/negative switching terminal (DI function No. 42) is invalid: PID output characteristic is positive</p> <p>P40.14 = 0 and PID positive/negative switching terminal (DI function No. 42) is valid: PID output characteristic is negative</p> <p>P40.14 = 1 and PID positive/negative switching terminal (DI function No. 42) is invalid: PID output characteristic is negative</p> <p>P40.14 = 1 and PID positive/negative switching terminal (DI function No. 42) is valid: PID output characteristic is positive</p>				
P40.15	Upper limit of PID output	-100.0%~100.0%	100.0%	☆
P40.16	lower limit of PID output	-100.0%~100.0%	0.0%	☆
P40.17	Proportional gain KP1	0.0~200.0%	5.0%	☆
P40.18	Integral time T11	0.00s (no any integral effect)~20.00s	1.00s	☆
P40.19	Differential time TD1	0.000s~0.100s	0.000s	☆
P40.20	Proportional gain KP2	0.00~200.0%.	5.0%	☆
P40.21	Integral time T12	0.00s (no any integral effect)~20.00s	1.00s	☆
P40.22	Differential time TD2	0.000s~0.100s	0.000s	☆
P40.23	PID parameter switchover condition	0: no switchover Do not switch, use KP1, T11, TD1 1: switchover via DI Switch by DI terminal	0	☆

		KP1, TI1, TD1 are used when DI terminal No. 41 function is invalid; KP2, TI2, TD2 are used when valid 2: automatic switchover based on deviation The absolute value of PID command and feedback deviation is less than P40.24, using KP1, TI1, TD1; the absolute value of deviation is greater than P40.25, using KP2, TI2, TD2 parameters; the absolute value of deviation is between P40.24~P40.25, The two sets of parameters are linearly transitioned.		
P40.24	PID parameter switchover deviation 1	0.0%~P40-25	20.0%	☆
P40.25	PID parameter switchover deviation 2	P40-24~100.0%	80.0%	☆
P40.26	PID integral separation threshold	0.0%~100.0%	100.0%	☆
P40.27	PID initial value	0.0%~100.0%	0.0%	☆
P40.28	PID initial value holding time	0.00~650.00s	0.00s	☆
This function is only valid when P40.39 = 0 which is not calculated. The PID output is reset after the inverter stops. If P40.28 ≠ 0, when the inverter runs, the PID output is equal to the initial value of PID and keeps the time of P40.28. .				
P40.29	PID deviation limit	0.0%~100.0%	0.0%	☆
P40.30	PID differential limit	0.00%~100.00%	1.00%	☆
P40.33	PID feedback filter time	0.000~30.000s	0.010s	☆
P40.34	PID output filter time	0.000~30.000s	0.010s	☆
P40.35	Detection value of PID feedback loss (lower limit)	0.0%(no detection)~100.0%	0.0%	☆
P40.36	Detection time of PID feedback loss	0.000s~30.000s	0.000s	☆
P40.37	Detection value of PID feedback loss(upper limit)	0.0%~100.0%(no detection)	100.0%	☆
P40.38	Upper Detection	0.000s~30.000s	0.000s	☆

	time of PID feedback loss			
P40.39	PID operation at stop	0-No PID operation at stop 1-PID operation at stop	0	☆
P40.40	PID command for accel and decel time	0.0s~6000.0s	0.0s	☆
P40.41	PID offset selection	0-digital setting 1-AI1 2-AI2 3-AI3(option card)	0	☆
P40.42	PID offset digital setting	-100.0%~100.0%	0.0%	☆
41 Group Sleeping function				
P41.00	Sleep mode and wake up selection	<p>Unit's digit: sleep mode selection</p> <p>0:no sleep function 1:sleep by frequency 2:A11 sleep (AI1 as pressure feedback) 3:AI2 sleep(AI2 as pressure feedback)</p> <p>Ten's digit :wake up mode selection</p> <p>0:wake up by frequency 1:AI1 wake up (AI1 as pressure feedback) 2:AI2 wake up (AI2 as pressure feedback)</p> <p>Hundred's digit :</p> <p>0: positive direction Feedback big then sleep, feedback small then wake up, P41.04 < P41.03 During running, pressure feedback > P41.03, the inverter sleeps When sleeping, pressure feedback < P41.04, the inverter wakes up</p> <p>1: reverse direction Feedback small then sleep, feedback big then wake up, P41.04 > P41.03 During running, pressure feedback < P41.03, inverter sleep When sleeping, pressure feedback > P41.04, the inverter wakes up</p> <p>➤ Normally, the frequency source is PID setting, and sleep by frequency wake-up direction is the same as the PID action direction P40.14.</p> <p>➤ Since the parameter setting is unreasonable, when the wake-up condition enables, even if the sleep condition is established, the sleep mode</p>	010	☆

		cannot be activated, and Pay special attention to avoid accident when use		
P41.01	Sleep setting value by frequency	0.00Hz~600HZ,It will sleep if value is less than this value	0.00Hz	☆
P41.02	Wake up threshold by frequency	0.00hz~600.00hz, ,It will wake up if value is bigger than this value	0.00Hz	☆
When selecting frequency sleep and frequency wake-up, it must be set by P41.01 < P41.02. When the frequency source is PID setting, and the frequency wake-up must be set to PID shutdown operation: P40.39 = 1.				
P41.03	Sleep setting value by pressure	0~100.0%	0.0%	☆
P41.04	Wake up threshold by pressure	0.~100.0%	0.0%	☆
P41.05	Sleep delay time	0.0s~6000.0s	0.0s	☆
P41.06	Wake up delay up	0.0s~6000.0s	0.0s	☆
P41.07	Sleep decelerating time	0.00(coast to stop)~60000s Setting value decide by P03.16 P03.16 = 2, 0.00~600.00s; P03.16 = 1, 0.0s~6000.0s; P03.16 = 0, 0s~60000s P41.07 set to 0,sleeping stop mode to free coast.	0.00s	☆
42 Group Simple PLC				
r42.00	PLC current running mode	Read only	-	●
r42.01	PLC current running remaining time	Read only	-	●
r42.02	PLC times of cycles	Read only	-	●
P42.03	Simple PLC running mode	Unit'digit:Running mode 0: Single cycle then stop 1: Single cycle then keep last speed 2: Recycle 3: Plc reset when single cycle stop Ten's digit:Saving selection at power off 0:Power off without saving 1:Power off with saving Hundred'digit:Power save selection at stop 0:Stop without power saving 1:stop with	003	☆

		saving		
P42.04	PLC running times	1~60000	1	☆
P42.05	PLC step 1 running time	0.0~6553.5 unit depend on P42.21 Notice:Running time do not conclude acceleration and deceleration time,same as following	0.0	☆
P42.06	PLC step 2 running time	0.0~6553.5 unit depend on P42.21	0.0	☆
P42.07	PLC step 3 running time	0.0~6553.5 unit depend on P42.21	0.0	☆
P42.08	PLC step 4 running time	0.0~6553.5 unit depend on P42.21	0.0	☆
P42.09	PLC step 5 running time	0.0~6553.5 unit depend on P42.21	0.0	☆
P42.10	PLC step 6 running time	0.0~6553.5 unit depend on P42.21	0.0	☆
P42.11	PLC step 7 running time	0.0~6553.5 unit depend on P42.21	0.0	☆
P42.12	PLC step 8 running time	0.0~6553.5 unit depend on P42.21	0.0	☆
P42.13	PLC step 9 running time	0.0~6553.5 unit depend on P42.21	0.0	☆
P42.14	PLC step 10 running time	0.0~6553.5 unit depend on P42.21	0.0	☆
P42.15	PLC step 11 running time	0.0~6553.5 unit depend on P42.21	0.0	☆
P42.16	PLC step 12 running time	0.0~6553.5 unit depend on P42.21	0.0	☆
P42.17	PLC step 13 running time	0.0~6553.5 unit depend on P42.21	0.0	☆
P42.18	PLC step 14 running time	0.0~6553.5 unit depend on P42.21	0.0	☆
P42.19	PLC step 15 running time	0.0~6553.5 unit depend on P42.21	0.0	☆
P42.20	PLC step 16 running time	0.0~6553.5 unit depend on P42.21	0.0	☆
P42.21	PLC running time unit	0:S;1:minute;2:hour	0	☆
P42.22	PLC step 1-4 ACCEL/DECEL time selector	Unit'digit:step 1 ACCEL/DECEL time selector ten'digit: step 2 ACCEL/DECEL time selector Hundred's: step 3 ACCEL/DECEL time selector Thousand'unit:step 4 ACCEL/DECEL time selector 0- ACCEL/DECEL time 1	0000	☆

		1- ACCEL/DECEL time 2 2- ACCEL/DECEL time 3 3- ACCEL/DECEL time 4		
P42.23	PLC step 5-8 ACCEL/DECEL time selector	Unit'digit: ACCEL/DECEL time 5 Ten'digit: ACCEL/DECEL time 6 Hundred'digit: ACCEL/DECEL time 7 Thousand'digit: ACCEL/DECEL time 8 0- ACCEL/DECEL time 1 1- ACCEL/DECEL time 2 2- ACCEL/DECEL time 3 3- ACCEL/DECEL time 4	0000	☆
P42.24	PLC step 9-12 ACCEL/DECEL time selector	Unit'digit: ACCEL/DECEL time 9 ten'digit: ACCEL/DECEL time 10 Hundred'digit: ACCEL/DECEL time 11 Thousand'digit: ACCEL/DECEL time 12 0- ACCEL/DECEL time 1 1- ACCEL/DECEL time 2 2- ACCEL/DECEL time 3 3- ACCEL/DECEL time 4	0000	☆
P42.25	PLC step 13-16 ACCEL/DECEL time selector	Unit's Digit: ACCEL/DECEL time 13 Ten'Digit: ACCEL/DECEL time 14 Hundred'digit: ACCEL/DECEL time 15 Thousand's digit: ACCEL/DECEL time 16 0- ACCEL/DECEL time 1 1- ACCEL/DECEL time 2 2- ACCEL/DECEL time 3 3- ACCEL/DECEL time 4	0000	☆
P42.26	PLC stop decelerating time	0.01~60000s Setting value decide by P03.16 P03.16 = 2, 0.00~600.00s; P03.16 = 1, 0.0s~6000.0s; P03.16 = 0, 0s~60000s	20.00s	☆
43 Group Programming delay-unit				
r43.00	Delay unit 1~6 output status	Read only,define as per bit:0000~1111 Bit0:delay unit 1; Bit1: delay unit 2 Bit2: delay unit 3; Bit3: delay unit 4 Bit4: delay unit 5; Bit5: delay unit 6	-	●
VFD500M inverter built-in 6 delay unit. The delay unit can collect the status of 0 ~ 15 bits of all parameters that can be viewed in the function code table, and finally output the delay unit status after delay processing and logic selection. Can be used for Di / Do, comparator / logic unit output delay and other functions, but also as a virtual relay.				

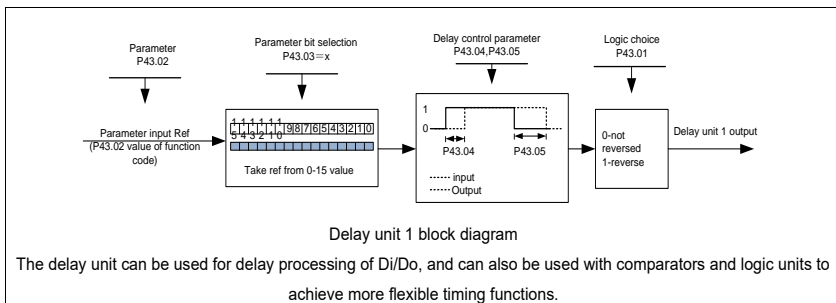

P43.01	Delay unit 1-6 logicl	000000B-111111B	0	☆
P43.02	Delay unit 1 input parameter selection	00.00-98.99(function code index)	0000	☆
P43.03	Delay unit 1 input bit selection	0-15	0000	☆
P43.04	Delayunit 1 on delay time	0.0s~3000.0s	0000	☆
P43.05	Delayunit 1 off delay time	0.0s~3000.0s	0000	☆
P43.06	Delay unit 2 input parameter selection	00.00-98.99(function code index)	0000	☆
P43.07	Delay unit 2 input bit selection	0-15	0000	☆
P43.08	Delay relay 2 on delay time	0.0s~3000.0s	0.0s	☆
P43.09	Delayunit2 off delay time	0.0s~3000.0s	0.0s	☆
P43.10	Delay unit 3 input parameter selection	00.00-98.99(function code index)	0.0s	☆
P43.11	Delay unit 3 input bit selection	0-15	0.0s	☆
P43.12	Delay unit3 on delay time	0.0s~3000.0s	0.0s	☆
P43.13	Delay unit3 off delay time	0.0s~3000.0s	0.0s	☆
P43.14	Delay unit 4 input parameter selection	00.00-98.99(function code index)	0.0s	☆
P43.15	Delay unit 4	0-15	0.0s	☆

	input bit selection			
P43.16	Delay relay 4 on delay time	0.0s~3000.0s	00.00	☆
P43.17	Delay unit4 off delay time	0.0s~3000.0s	0.0s	☆
P43.18	Delay unit 5 input parameter selection	00.00-98.99(function code index)	00.00	☆
P43.19	Delay unit 5 input bit selection	0-15	0	☆
P43.20	Delay unit5 on delay time	0.0s~3000.0s	0.0s	☆
P43.21	Delay unit5 off delay time	0.0s~3000.0s	0.0s	☆
P43.22	Delay unit 6 input parameter selection	00.00-98.99(function code index)	00.00	☆
P43.23	Delay unit 6 input bit selection	0-15	0	☆
P43.24	Delay unit6 on delay time	0.0s~3000.0s	0.0s	☆
P43.25	Delay unit6 off delay time	0.0s~3000.0s	0.0s	☆
44 Group Variable selector and logic block				
r44.00	Variable selector 1~4 output	bit0~3 indicate the output of variable selector 1-4	-	●
r44.01	Logic block 1~4 output	bit0~3 indicate the output of logic block 1~4	-	●
P44.02	Variable selector 1 input parameter	00.00~98.99(Function code index)	00.00	☆
P44.03	Variableselector 1 threshold	00.00~98.99(Function code index)	00.00	☆
P44.04	Variable selector 1 logic mode	0:>; 1:<; 2:≥;3:≤;4:=; 5:≠; 6:≈	0	☆
P44.05	Variableselector 1 hysteresis width	0~65535	0	☆
<p>VFD500M inbuilt 4 group variable selector,this function can be used for any two function code parameters,by selecting the comparison relationship, and output will be 1 if it meet conditions or it will be 0.Variable selector output can act as DI,VDI,virtual relay input and DO,relay.etc output.Users can easily and flexibly get logic function ,variable selector 1 frame as follows</p>				

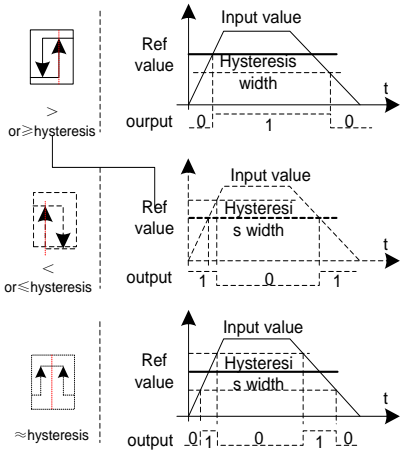
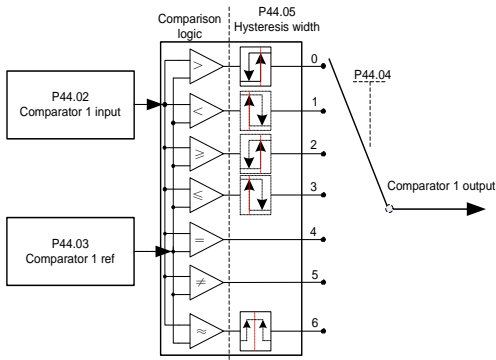

TOP:variable selector graph BOTTOM: hysteresis width graph

P44.06	Variable selector 2 input parameter	00.00-98.99(function code index)	00.00	☆
P44.07	Variable selector 2 threshold	00.00-98.99(function code index)	00.00	☆
P44.08	Variable selector 2 logic mode	0:>; 1:<; 2:≥;3:≤;4:=; 5:≠; 6:≈	0	☆
P44.09	Variable selector 2 hysteresis width	0~65535	0	☆
P44.10	Variable selector 3 input parameter	00.00-98.99(function code index)	00.00	☆
P44.11	Variable selector 3 threshold	00.00-98.99(function code index)	00.00	☆
P44.12	Variable selector 3 logic mode	0:>; 1:<; 2:≥;3:≤;4:=; 5:≠; 6:≈	0	☆

P44.13	Variable selector 3 hysteresis width	0~65535	0	☆
P44.14	Variable selector 4 input parameter	00.00-98.99(function code index)	00.00	☆
P44.15	Variable selector 4 threshold	00.00-98.99(function code index)	00.00	☆
P44.16	Variable selector 4 logic mode	0:>; 1:<; 2:≥;3:≤;4:=; 5:≠; 6:≈	0	☆
P44.17	Variable selector 4 hysteresis width	0~65535	0	☆
P44.18	Logic block 1 threshold parameter 1	00.00-98.99(function code index)	00.00	☆
P44.19	Logic block 1 threshold parameter2	00.00-98.99(function code index)	00.00	☆
P44.20	Logic block 1 input source	Unit'digit: parameter 1 bit selection 0-F (Represent 0-15),P44.18 corresponds to 0-15 bit Ten'digit:parameter 2 bit selection 0-F (Represent 0-15),P44.19 corresponds to 0-15 bit	0	
P44.21	Logic block 1 function	0:no function;1:and;2:or;3:not and;4:not or;5:Xor 6:Ref=1 effective;Ref2=1 ineffective 7:Ref1 up effective,Ref2 up ineffective 8:Ref1 up and signal reverse 9:Ref1 up and output 200ms pulse width 10:Ref2=0 ineffective always;Ref2=1,Ref1 up effective	0	☆
<p>VFD500M built-in 4 logical units. The logic unit can perform any one of 0-15 bits of any parameter 1 and any one of 0-15 bits of any parameter 2 for logic processing. The condition is true output 1, otherwise 0 is output. Logic unit output can be used as DI, VDI, delay unit and other inputs, DO, relays and other output, the user can more flexible access to the required logic. The schematic block diagram of the logic unit 1 is as follows.</p>				
P44.22	Logic block 2 threshold parameter 1	00.00-98.99(function code index)	00.00	☆

P44.23	Logic block 2 threshold parameter2	00.00-98.99(function code index)	00.00	☆
P44.24	Logic block 2 input source	Unit'digit: parameter 1 bit selection 0-F (Represent 0-15),P44.22 corresponds to 0-15 bit Ten'digit:parameter 2 bit selection 0-F (Represent 0-15),P44.23 corresponds to 0-15 bit	0	☆
P44.25	Logic bock 2 function	0:no function;1.and;2.or;3.not and;4.not or;5:Xor 6:Ref=1 effective;Ref2=1 ineffective 7:Ref1 up effective,Ref2 up ineffective 8:Ref1 up and signal reverse 9:Ref1 up and output 200ms pulse width	0	☆
P44.26	Logic block 3 threshold parameter 1	00.00-98.99(function code index)	00.00	☆
P44.27	Logic block 3 threshold parameter2	00.00-98.99(function code index)	0	☆
P44.28	Logic block 3 input source	Unit'digit: parameter 1 bit selection 0-F (Represent 0-15),P44.26 corresponds to 0-15 bit Ten'digit:parameter 2 bit selection 0-F (Represent 0-15),P44.27 corresponds to 0-15 bit	0	☆
P44.29	Logic bock 3 function	0:no function;1.and;2.or;3.not and;4.not or;5:Xor 6:Ref=1 effective;Ref2=1 ineffective 7:Ref1 up effective,Ref2 up ineffective 8:Ref1 up and signal reverse 9:Ref1 up and output 200ms pulse width	0	☆
P44.30	Logic block 4 threshold parameter 1	00.00-98.99(function code index)	00.00	☆
P44.31	Logic block 4 threshold parameter2	00.00-98.99(function code index)	00.00	☆
P44.32	Logic block 4 input source	Unit'digit: parameter 1 bit selection 0-F (Represent 0-15),P44.30 corresponds to 0-15 bit Ten'digit:parameter 2 bit selection 0-F (Represent 0-15),P44.31 corresponds to 0-15 bit	0	☆

P44.33	Logic block 4 function	0:no function;1.and;2.or;3:not and;4:not or;5:Xor 6:Ref=1 effective;Ref2=1 ineffective 7:Ref1 up effective,Ref2 up ineffective 8:Ref1 up and signal reverse 9:Ref1 up and output 200ms pulse width 10:Ref2=0 ineffective always;Ref2=1,Ref1 up effective	0	☆
P44.34	Constant setting 1	0~65535	0	☆
P44.35	Constant setting 2	0~65535	0	☆
P44.36	Constant setting 3	0~65535	0	☆
P44.37	Constant setting 4	-9999~9999	0	☆
P44.38	Constant setting 1 as per bit definition	0~65535(define as bit)	0	☆
P44.39	Constant setting 2 as per bit definition	0~65535(define as bit)	0	☆
P44.40	Constant setting 3 as per bit definition	0~65535(define as bit)	0	☆
P44.41	Constant setting 4 as per bit definition	0~65535(define as bit)	0	☆
Constant setting for reference of variable selector or logic block input				
45 Group Multi-functional counter				
r45.00	Counter 1 input value	The count value before the electronic gear, that is, the number of pulses received by the counter 1 hardware, 32-bit read-only data	-	●
r45.02	Counter 1 count value	Count value after electronic gear, 32-bit read-only data	-	●
P45.04	Counter 1 set value	1 to 4294967295, when the counter 1 count value (after the electronic gear) reaches this setting, the DO function "Counter 1 set value reached" is valid.	1000	☆
P45.06	Counter 1 maximum value	1 to 4294967295, set the maximum value of counter 1 (after electronic gear)	4294967295 5	☆
P45.08	Counter 1 Electronic gear numerator	1~65535 Counter 1 count value = counter 1 input value ×(electronic gear numerator / electronic gear denominator)	1	☆

P45.09	Counter 1 Electronic gear denominator	1~65535	1	☆
<p>VFD500M has two inbuilt counters:counter 1 is for 32 bit multifunctional counter with electronic gear;Counter 2 is a common counter with 16 bit without electronic gear.following is counter 1 function and use.</p> <p>Counter 1 get input pulse signal via DI function 50 (counter 1 Input),when counter 1 comes to setting value (P45.04) via electronic gear,it can come to signal via DO function (21) and counter will continue to count</p> <p>When counter arrive maximum value,it will decide to overflow as per P45.13</p> <p>Set Di(51) terminal to Count1 reset ,when terminal effective,counter 1 will reset</p> <p>For example: P45.04=3, P45.08=3, P45.09=1,Count 1 functoin as following picture</p>				
<p>The diagram shows a sequence of pulses for 'Counter input'. Below it, two rows show counter values: 'Counter1 before electronic gear' and 'Counter1 after electronic gear'. The first row shows values 1-9, then a break, then 0-4. The second row shows values 1-3, then a break, then 0-1. A 'Set value arrival output' signal is shown as a pulse that occurs when the counter reaches its set value. A 'Counter reset DI input' signal is shown as a pulse that resets the counter.</p>				
r45.10	Counter 2(16 bit) actual value	Read only and save when power off	-	●
P45.11	Counter 2 (16 bit) set value	When the count value of counter 2 reaches this setting, the DO function "counter 2 set value reached" is valid.Setting range: 1~65535	1000	☆
P45.12	Counter2 (16 bit) maximum value	1~65535, set the maximum value of counter 2.Setting range: 1~65535	65535	☆
P45.13	Counter 1 Control	<p>Ones place: counting method 0: stop counting after reaching the maximum value 1: Reset after the maximum value is counted, and recount from 0</p> <p>Tens place: the action after the counter reaches the set value 0: Continue to run 1: Free stop 2: Reduced speed to stop 3: Emergency stop</p> <p>Hundred's place: Power-down save option 0: The count value is not saved after power failure1: Save count value when power off</p>	11	☆
P45.14	Counter 2 Control	<p>Ones place: counting method 0: stop counting after reaching the maximum value 1: Reset after the maximum value is counted, and recount from 0</p> <p>Tens place: the action after the counter reaches the set value 0: Continue to run 1: Free stop 2: Reduced speed to stop 3: Emergency stop</p> <p>Hundred's place: Power-down save option 0: The count value is not saved after power</p>		

		failure1: Save count value when power off		
Count 1/2 overflow action:when counter higher than maximum value as following chart				
	<p>Maximum setting Counter value</p> <p>Pulse input</p> <p>Stop counting</p> <p>Continue counting after overflowing</p>			
60 Group Motor 2 basic parameter				
P60.00	Control mode	Same as P00.04	0	★
P60.01	Upper limit frequency	Same as P01.07	0	★
P60.02	Upper limit frequency digital setting	Lower limit (P01.09) ~ maximum frequency(P01.06)	50.00Hz	☆
P60.04	Accel and Decel time option	0: same as motor 1 1: Accel and Decel time 3 When choose 1, Motor 2 can convert between accel and decal time 3 and 4 by DI terminal function code 55 or switch by output frequency comparing with P60.05 P60.06)	0	★
P60.05	Accel time frequency switchover 2	0.00Hz~maximum frequency (P01.06)	0.00Hz	☆
P60.06	Decel time frequency switchover 2	0.00Hz~maximum frequency(P01.06)	0.00Hz	☆
61 Group Motor2 parameter				
61.xx same as motor 1 parameter P11.xx				
62 Group Motor 2 VF control parameter				
62.xx same as motor 1 VF control P12.xx				
63 Group Motor 2 Vector control parameter				
63.xx same as motor 2 Vector control P13.xx				

Chapter 6 Fault Diagnosis and Solution

VFD500M inverter has 32 types of warning information and protection function. In case of abnormal fault, the protection function will be invoked, the inverter will stop output, and the faulty relay contact of the inverter will start, and the fault code will be displayed on the display panel of the inverter.

Before consulting the service department, the user can perform self-check according to the prompts of this chapter, analyze the fault cause and find out solution. If the fault is caused by the reasons as described in the dotted frame, please consult the agents of inverter or factory directly.

Fault Name	Fault code	Display	Possible Causes	Solutions
Inverter unit protection	1	Er. SC	1: Motor insulation aging 2: The cable is damaged and contact, short circuit 3: The distance between motor and inverter are too long. 4: Output transistor breakdown 5: The internal wiring of the inverter is loose, or the hardware is bad. 6: Brake transistor short circuit	1. Confirm the insulation resistance of the motor. If it is turned on, replace the motor. 2. Check the power cable of the motor 3. Install reactor or output filter 4. seeking technical support 5. seeking technical support 6. Check if the braking resistor is damaged and the wiring is correct.
Over current during acceleration	2	Er.OC1	1: The output circuit is grounded or short circuited. 2: Motor auto-tuning is not performed. 3: The acceleration time is too short. 4: Manual torque boost or V/F curve is not appropriate. 5: The voltage is too low. 6: The startup operation is performed on the rotating motor. 7: A sudden load is added during acceleration. 8: The frequency inverter model is of too small power class.	1: Eliminate external faults. 2: Perform the motor auto-tuning in cold state 3: Increase the acceleration time. 4: Adjust the manual torque boost or V/F curve. 5: Adjust the voltage to normal range. 6: Select rotational speed tracking restart or start the motor after it stops. 7: Remove the added load. 8: Select a frequency inverter Of higher power class.
Over current during deceleration	3	Er.OC2	1: The output circuit is grounded or short circuited. 2: Motor auto-tuning is not performed. 3: The deceleration time is too short. 4: The voltage is too low. 5: A sudden load is added during deceleration. 6: The braking unit and braking resistor are not installed	1: Eliminate external faults. 2: Perform the motor auto-tuning. 3: Increase the deceleration time. 4: Adjust the voltage to normal range. 5: Remove the added load. 6: Install the braking unit And braking resistor.

Fault Name	Fault code	Display	Possible Causes	Solutions
Over current at constant speed	4	Er.OC3	1: The output circuit is grounded or short circuited. 2: Motor auto-tuning is notperformed. 3: The voltage is too low. 4: A sudden load is added during operation. 5: The frequency inverter model is of too small power class.	1:Eliminate external faults. 2: Perform the motor auto-tuning. 3:Adjust The voltage to normal range. 4: Remove the addedload. 5: Select a frequency Inverter of higher power class.
Overvoltage during acceleration	5	Er.OU1	1:The input voltage is too high 2:The surge voltage is mixed in the input power supply. 3: There is an external force to drive the motor to run, or the brake type load is too heavy 4:The acceleration time is too short 5:The motor is shorted to ground	1:the power supply voltage is reduced to the normal range 2:install DC reactor 3:Cancel the external force of the draggable motor or install the brake unit 4: increase the acceleration time 5:eliminate the part of the ground short circuit
Overvoltage during deceleration	6	Er.OU2	1:The input voltage is too high 2:The surge voltage is mixed in the input power supply. 3: There is an external force to drive the motor to run, or the brake type load is too heavy 4:The deceleration time is too short 5:The motor is shorted to ground	1:the power supply voltage is reduced to the normal range 2:install DC reactor 3:Cancel the external force of the draggable motor or install the brake unit 4: increase the deceleration time 5:eliminate the part of the ground
Overvoltage at constant speed	7	Er.OU3	1:The input voltage is too high 2:The surge voltage is mixed in the input power supply. 3: There is an external force to drive the motor to run, or the brake type load is too heavy 4:The acceleration or deceleration time is too short 5:The motor is shorted to ground	1:the power supply voltage is reduced to the normal range 2:install DC reactor 3:Cancel the external force of the draggable motor or install the brake unit 4: increase the acceleration or deceleration time 5:eliminate the part of the ground

Fault Name	Fault code	Display	Possible Causes	Solutions
Low voltage	8	Er.Lv1	<p>1: Instantaneous power failure occurs on the input power supply or input phase loss</p> <p>2: The frequency inverter's input voltage is not within the allowable range.</p> <p>3: Cut off the power during operation</p> <p>4:The internal wiring of the inverter is loose, or the hardware is bad.</p>	<p>1:Check if the input power supply is abnormal, whether the input power terminal is loose, whether the input contactor or the air switch is abnormal.</p> <p>2:adjust the voltage to the normal range</p> <p>3:Power off after the inverter stops</p> <p>4:seeking technical support</p> <p>5: For the unstable power supply, if the performance requirements are low, try to enable the undervoltage stall function (P23.00).</p>
Contactor open	9	Er.Lv2	<p>1: Instantaneous power failure occurs on the input power supply</p> <p>2: The frequency inverter's input voltage is not within the allowable range.</p> <p>3: Cut off the power during operation</p> <p>4:the internal wiring of the inverter is loose, or the hardware is bad.</p>	<p>1:Check if the input power supply is abnormal, whether the input power terminal is loose, whether the input contactor or the air switch is abnormal.</p> <p>2:adjust the voltage to the normal range</p> <p>3:Power off after the inverter stops</p> <p>4:seeking technical support</p> <p>5: For the unstable power supply, if the performance requirements are low, try to enable the undervoltage stall function (P23.00).</p>
Frequency inverter overload	10	Er. oL	<p>1:The load is too large or the motor is blocked.</p> <p>2:The large inertia load acceleration and deceleration time is too short</p> <p>3: When the VF is controlled, the torque boost or V/F curve is not suitable.</p> <p>4:The frequency converter selection is too small</p> <p>5:Overload at low speed operation</p>	<p>1. Reduce the load and check the motor and mechanical conditions.</p> <p>2. increase the acceleration and deceleration time</p> <p>3. Adjust the torque boost or V/F curve</p> <p>4. select the inverter with a larger power level</p> <p>5. Perform motor self-learning in cold state and reduce carrier frequency at low speed</p>

Fault Name	Fault code	Display	Possible Causes	Solutions
Motor overload	11	Er.oL1	1:The load is too large or the motor is blocked. 2:The large inertia load acceleration and deceleration time is too short 3:When the VF is controlled, the torque boost or V/F curve is not suitable. 4:The motor selection is too small 5:Overload at low speed operation 6:Improper setting of motor parameters and motor protection parameters	1. Reduce the load and check the motor and mechanical conditions. Correctly set the motor parameters and motor protection parameters. 2, increase the acceleration and deceleration time 3. Adjust the torque boost or V/F curve 4, select a motor with a higher power level 5. Perform motor self-learning in cold state and reduce carrier frequency at low speed 6, check the settings of related parameters
Power input phase loss	12	Er.iLP	1: The three-phase power input is abnormal. 2: The drive board is faulty. 3: Thelighting proof board is faulty. 4: The main control board is faulty.	1:Eliminate external faults. 2: Ask for technical support. 3: Ask for technical support. 4: Ask for technical support.
Power output phase loss	13	Er.oLP	1: The cable connecting the frequency inverter and the motor is faulty. 2: The frequency inverter's three-phase outputs are unbalanced when the motor is running. 3: The drive board is faulty. 4: The IGBT module is faulty.	1:Eliminate external faults. 2: Check whether the Motor three phase winding is normal. 3: Ask for technical support. 4: Ask for technical support.

Fault Name	Fault code	Display	Possible Causes	Solutions
IGBT Module overheat	14	Er. oH	<ol style="list-style-type: none"> 1: The ambient temperature is too high. 2: The air filter is blocked. 3: The fan is damaged. 4: The thermally sensitive resistor of the IGBT module is damaged. 5: The inverter IGBT module is damaged 	<ol style="list-style-type: none"> 1: Lower the ambient temperature. 2: Clean the air filter. 3: Replace the damaged fan. 4: Replace the damaged thermally sensitive resistor. 5: Replace the inverter module.
Motor overheat	16	Er. oH3	<ol style="list-style-type: none"> 1: The temperature sensor wiring is loose 2: The motor temperature is too high 3: The motor temperature sensor detects that the temperature is greater than the set threshold. 	<ol style="list-style-type: none"> 1: Check the temperature sensor wiring 2: Improve the carrier frequency, strengthen the heat dissipation of the motor, reduce the load, and select a motor with higher power. 3: Check if the set threshold is reasonable.
By wave current limiting fault	17	Er.CbC	<ol style="list-style-type: none"> 1: The load is too heavy or locked-rotor occurs on the motor. 2: The frequency inverter model is of too small power class 	<ol style="list-style-type: none"> 1: Reduce the load and check the motor and mechanical condition. 2: Select a frequency inverter of higher power class.
Ground short circuit	18	Er.GF	<ol style="list-style-type: none"> 1. Motor burnout or insulation aging 2. The cable is damaged and contact, short circuit 3. The distributed capacitance of the terminal and motor cable is larger \oplus motor cable 4. Hardware is broken 	<ol style="list-style-type: none"> 1. Confirm the insulation resistance of the motor. If it is turned on, replace the motor. 2. Check the power cable of the motor to eliminate the fault point. 3. reduce the carrier frequency, install the output reactor 4. seeking technical support
module temperature detection fault	20	Er.tCK	<ol style="list-style-type: none"> 1, Temperature detection line broken 2, Drive board is faulty 3. Main control board is faulty 4, The environmental temperature is too low 	<ol style="list-style-type: none"> 1. Check the thermistor wiring 2. Ask for technical support 3. Ask for technical support 4, manual intervention to drive the temperature rise
Current detection fault	21	Er.CUR	<ol style="list-style-type: none"> 1: The HALL device is faulty. 2: The drive board is faulty. 3: The control board is faulty 	<ol style="list-style-type: none"> 1: Replace the faulty HALL device. 2: Replace the faulty drive board. 3: Ask for technical support.

Fault Name	Fault code	Display	Possible Causes	Solutions
Motor over-speed	25	Er. oS	1: The encoder parameters are set incorrectly. 2: The motor auto-tuning is not performed. 3: The over-speed detection parameters are set incorrectly	1: Set the encoder parameters properly. 2: Perform the motor auto-tuning. 3: Set the over-speed detection parameter correctly based on the actual situation.
Too large speed deviation	26	Er.DEV	1: The encoder parameters are set incorrectly. 2: The motor auto-tuning is not performed. 3: The detection parameters of too large speed deviation are set incorrectly.	1: Set the encoder parameters properly. 2: Perform the motor auto-tuning. 3: Set the detection parameters correctly based on the actual situation.
Motor auto-tuning fault 1	27	Er.tU1	1: The motor parameters are not set according to the nameplate. 2: The motor auto-tuning times out.	1: Set the motor parameters according to the nameplate properly. 2: Check the cable connecting between the Frequency inverter and the motor.
Motor auto-tuning fault 2	28	Er.tU2	1: The motor parameters are not set according to the nameplate. 2: The motor auto-tuning times out.	1: Set the motor parameters according to the nameplate properly. 2: Check the cable connecting between the Frequency
Off load	31	Er. LL	1、 The frequency inverter running current is lower than the setting value.	1、 Confirm whether the load is off 2、 Check that the load is disconnected or the parameter setting is correct
EEPROM read- write fault	32	Er.EEP	1、 Eeprom Operate too frequent 2、 The EEPROM chip is damaged.	1、 Operate Eeprom suitable 2、 Replace the main control board
Running time arrival	33	Er.TTA	Inverter trial time arrival	1: Contact agent or distributor
485 Communication fault	34	Er.485	1, the work of the host computer is not normal 2, the communication line is not normal 3, the communication parameter set is incorrect	1. Check the connection of upper computer 2. Check the communication connection line 3. Set communication parameters correctly
PID feedback lost during running	36	Er.FbL	1、 PID feedback < P40.35 setting value and P40.36 not zero, PID feedback > P40.37 setting value and P40.38 not zero	1、 check PID feedback signal 2、 P40.35 and P40.37 set correct parameter
User-defined fault 1	37	Er.Ud1	1: The signal of user-defined fault 1 is input via DI. 2: The signal of user-defined fault 1 is input via virtual I/O.	1: Reset the operation. 2: Reset the operation

Fault Name	Fault code	Display	Possible Causes	Solutions
User-defined fault 2	38	Er.Ud2	1: The signal of user-defined fault 2 is input via DI. 2:The signal of user-defined fault 2 is input via virtual I/O.	1: Reset the operation. 2: Reset the operation



The fault code is used for the communication read fault type: when the communication reads the registers r25.00, r26.00, r26.08, r26.16, the register contents of the reply are fault coded.

6.2 Warning type

The warning is used to remind and inform the user of the current state of the inverter. When the warning occurs, the keypad will display a warning message, and the warning will automatically reset when the warning is cleared. Some warnings require the user to check the cause before running the drive, and some do not care. Warning As an instant reminder, the drive does not store the corresponding information. Bit 12 of r27.10 indicates whether there is a warning message currently.

Warning name	Warning code	Display	Reason	Measure
Insufficient power	1	PoFF	1: The DC link voltage is insufficient and cannot be started normally.	1:Check if the inverter power supply is normal.
Wrong parameter	2	A.PAR A	1: The parameter settings are wrong, such as: The torque mode is set in the VF control mode.	1:Modify and check theparameter compatibility problem
Sleeping status	5	SLEEP	1. The system is in a sleep state, and the system will automatically start when hibernation is over.	1:Generally no need to pay attention to it



The warning code is used for the communication read warning type: when the communication reads register r25.16, the contents of the returned register are the warning code.

Chapter 7 Daily maintenance of frequency inverters

8.1 Daily maintenance

Due to the influence of temperature, humidity, dust and vibration, it will lead to poor heat dissipation and component aging of frequency inverter, and results in potential failure or reducing the service life of frequency inverter. Therefore, it is necessary to do daily and regular maintenance of the frequency inverter.

8.1.1 Daily maintenance

Due to the influence of temperature, humidity, dust and vibration, it will lead to poor heat dissipation and component aging of frequency inverter, and results in potential failure or reducing the service life of frequency inverter. Therefore, it is necessary to do daily and regular maintenance of the frequency inverter.

Daily check items:

- 1) Check if the sound is normal during the running of the motor;
- 2) Check if there is a vibration during the running of the motor;
- 3) check whether the installation environment of frequency inverter has changed;
- 4) Check if the cooling fan of frequency inverter is working correctly, the cooling air duct is clear;
- 5) Check if the frequency inverter is overheating;
- 6) Make sure that the frequency inverter should always be kept in a clean state;
- 7) Clear up effectively the dust on the surface of frequency inverter, prevent the dust from entering into the inside of frequency inverter, especially for the metal dust;
- 8) Clear up effectively the oil and dust on the cooling fan of frequency inverter.

8.1.2 Regular inspection

Please regularly check the frequency inverter, especially for the difficult checking place of running.

Regular inspection items:

- 1) Check the air duct and clear up regularly;
- 2) Check if there are any loose screws;
- 3) Check if the inverter has been corroded;
- 4) Check whether the wiring terminals show signs of arcing;
- 5) Main circuit insulation test.

Note: When using the megger(please use the DC 500V meg ohm meter) to measure the insulation resistance, you shall disconnect the main circuit with the frequency inverter. Do not use the insulation resistance meter to test the control circuit. It don't have to do the high voltage test (It has been done when the frequency inverter produced in factory.)

8.2 Wearing parts replacement

The wearing parts of frequency inverter include the cooling fan and filter electrolytic capacitor, its service life is closely related to the using environment and maintenance status. The general service life is shown as follows:

Part Name	Service Life
Fan	2 ~ 3 Years

Electrolytic capacitor	4 ~ 5 Years
------------------------	-------------

The user can confirm the replace time according to the running time.

- 1) Possible reasons for the damage of cooling fan: bearing wear and vane aging. Distinguish standard: Any cracks in the fan vanes, any abnormal vibration sound during the starting of frequency inverter.
- 2) Possible reasons for the damage of filter electrolytic capacitor: poor quality of the input power supply, the environment temperature is high, the load change frequently and the electrolyte aging. Distinguish standard: Any leakage of its liquid, if the safety valve is protruding, electrostatic capacitance and insulation resistance measurement.

8.3Warranty Items

- 1) Warranty only refers to frequency inverter.
- 2) Under normal use, if there is any failure or damage, our company is responsible for the warranty within 18 months. (Leave factory date is subjected to the S/N on the frequency inverter nameplate or according to the contract). When over 18 months, reasonable fee will be charged for maintenance;
- 3) During the period of 18 months, if the following situation happens, certain maintenance fee will be charged;
 - a. The users don't follow the rules in the manual lead to the frequency inverter damaged;
 - b. The damage caused by fire, flood and abnormal voltage;
 - c. The damage caused by using the frequency inverter for abnormal functions;
 - d. The relevant service fee is calculated according to the manufacturer's standard, if there is an contract, then it is subject to the contract items.

Appendix A Modbus communication protocol

VFD500M series of inverter provides RS485 communication on interface, and adopts MODBUS communication protocol. User can carry out centralized monitoring through PC/PLC to get operating

requirements and user can set the running command, modify or read the function codes, the workingstate or fault information of frequency inverter by Modbus communication protocol. In addition VFD 500 can also be used as a host to broadcast with other VFD500 communication.

A.1 Protocol format

RS485 asynchronous half-duplex.

RS485 terminal default data format: 1-8-N-1 (1 start bit, 8 data bits, no parity, 1 stop bit), the default baud rate: 9600bps. See parameter group set 30.

A.2 Message format

The VFD500M series inverter Modbus message includes the start sign, the RTU message, and the end sign.

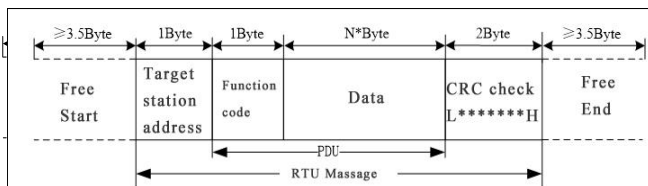

The RTU message includes the address code, the PDU (Protocol Data Unit, the protocol data unit), and the CRC check. PDU includes the function code and the data section.

RTU frame format:

Frame start (START)	More than the 3.5 byte transmission time	
Target station address (ADR)	Communication address: 1 to 247(0: broadcast address)	
Command code (CMD)	Command code	Description
	0x03	Read multiple registers of the AC drive
	0x06	Write a single register to the AC drive.
	0x10	Write Multiple registers to the AC drive.
	0x08	Diagnostic command code
Number of function code	Including the register address (2Byte), the number of registers n(2Byte) and the register content (2nByte), etc. see A3 in detail	
CRC CHK low level	It indicates the replying data or the data waiting to write-in. CRC 16 check value, During the transmission, high bit is put in front and low bit is at the back. see detail in A.5 Chapter	
CRC CHK high level		
FRAME END	More than 3.5 byte transmission time	

A.3 Command code instruction

A.3.1 Command code 0x03 Read multiple registers or status words

● Request PDU

Command code	1byte	0x03
initial address	2byte	0x0000~0xFFFF(high 8 bit in front)
Number of registers	2byte	0x0001-0x0010 (1~16,high 8 bit in front)

● Response PDU

Command code	1byte	0x03
Initial address	1byte	2n (n means Number of registers)
Number of registers	2* nbyte	Register value high 8 bit in front,first send initial address'register value

● Wrong PDU

Command code	1byte	0x83
Abnormal code	1byte	See A.4Abnormal response information

Currently Modbus protocol 0x03 command code does not support cross-group read multiple function codes, it will be wrong if more than the current group of function code number

A.3.2 Command code 0x06 write single registers or status word command codes

Request PDU

Command code	1byte	0x06
Initial address	2byte	0x0000~0xFFFF(high 8 bit in front)
Register value	2byte	0x0000~0xFFFF(register value high 8 bit in front)

● Respond PDU

Command code	1byte	0x06
Register address	2byte	0x0000~0xFFFF
Register value	2byte	0x0000~0xFFFF

● Wrong PDU

Command code	1byte	0x86
Abnormal code	1byte	See A4 Abnormal response information

A.3.3 Command 0x10 write multiple registers or status word command codes

● Request PDU

Command code	1byte	0x10
Initial address	2byte	0x0000~0xFFFF(high 8 bit in front)
Number of Register	2byte	0x0001~0x0010(1~16, high 8 bit in front)
Number of Byte	1byte	2n (n is number of Register)

Register Value	2* nbyte	Register value high 8 bit in front, first send initial address register value
----------------	----------	---

- **Respond PDU**

Command code	1byte	0x10
Initial address	2byte	0x0000 ~ 0xFFFF(high 8 bit in front)
Number of register	2byte	1~16(1~16, high 8 bit in front)

- **Wrong PDU**

Command code	1byte	0x90
Abnormal Code	1byte	See Abnormal response information

A.3.4 Command code 0x08 Diagnostic function

- Modbus Command Code 0x08 Provide a series of tests to check the communication system between the client (master) device and the server (slave) or various internal error conditions in the server.
- This function uses the sub-command code of 2 bytes inquiry to define the type of test to be performed. The server copies the command and subcommand codes in the normal response. Some diagnostics cause the remote device to return the data through the normally responding data fields.
- Diagnostic functions to remote devices generally do not affect the user program running in the device. The main diagnostic function of this product is not line diagnosis (0000), used to test the host from the machine is normal communication.
- Request PDU

Command code	1byte	0x08
Subcommand code	2byte	0x0000~0xFFFF
Data	2byte	0x0000~0xFFFF

Respond PDU

Command code	1byte	0x08
Subcommand code	2byte	0x0000
Data	2byte	Same as request of PDU

Wrong PDU

Command code	1byte	0x88
Abnormal code	1byte	See Abnormal response information

A.4 Abnormal response information

When the master device sends a request to the slave device, the master expects a normal response. The master's query may result in one of four events:

- (1) If the slave device receives a request for a communication error and the query can be processed normally, the slave device will return a normal response.
- (2) If the slave device does not receive the request due to a communication error, no information can be returned and the slave device times out.
- (3) If the slave device receives a request and detects a communication error (parity, address, framing error, etc.), no response is returned and the slave device times out.
- (4) If the slave device receives no communication error request, but can not handle the request (such as the register address does not exist, etc.), the slave station will return an

abnormal response to inform the master of the actual situation.

**Abnormal response command code = normal response command code + 0x80,
Abnormal code value and meaning as shown in the following table**

Error code	Name	Description
0x01	Invalid command code/error function code	The function code received by the slave is outside the configured range
0x02	Error data address/Illegal register address	Slave station receives the data address is not allowed address the number of registers being Read and write is out of range When writing multiple registers, the number of bytes in the PDU is not equal to the number of registers
0x03	wrong frame format	Length of frame is not correct CRC verifying not passed
0x04	Data is out of range	The data received by the slave exceeds the corresponding register minimum to maximum range
0x05	Reading request refuse	Operate to read-only register write Operate to read-only register write in running status

A.5 CRC check

CRC (Cyclical Redundancy Check) use RTU frame. The message includes an error detection field based on the CRC method. The CRC field examines the contents of the entire message. The CRC field is two bytes containing a binary value of 16 bits. It is calculated by the transmission equipment and added to the message. The receiving device recalculates the CRC of the received message and compares it with the value in the received CRC field. If the two CRC values are not equal, there is an error in the transmission. There is a lot of information on the Internet about CRC checking it is not elaborated hereabout CRC check code generation algorithm,

A.6 Register address distribution

The register address of VFD500M is 16-bit data, the upper 8 bits represent the function code group number, the lower 8 bits represent the group number, the upper 8 bits are sent before. The 32-bit register occupies two adjacent addresses, the even address stores the lower 16 bits, and the next address (odd address) of the even address stores the upper 16 bits.

In the register write operation, in order to avoid frequent damage caused by memory EEPROM write, using the highest bit of the register address indicates whether it save as EEPROM, the highest bit to be 1 indicates to save in EEPROM, 0 means save only in RAM. In other words, if you want to write the register value which is saved after power-off, you should add 0x8000 to the original register address.

VFD500M register address as follows:

Adress space	Descriptoin
0x0000 ~ 0x6363	High 8 bit means group number (0-99), low 8 bit means within group serial number (0-99), illustrated by hexadecimal for Example: Example 1: Function code 06.19, with address is 0x0613 (0x06=6, 0x13=19). Example 2: Function code 27.06, with address is 0x1B06 (0x1B=27, 0x06=6). Example 3: Function code 40.15, with address is 0x280F (0x28=40, 0x0F=15).

Communicatoin special address	0x7000	Communication command.The values and functions are as follows: 0x0000: disable command ; 0x0001: forward running; 0x0002: reverse running; 0x0003: forward jog; 0x0004: reverse jog; 0x0005: free stop; 0x0006: decelerating stop; 0x0007: immediate stop; 0x0008: fault reset;																																
	0x7001	Communication speed given. The unit of this register can be set by P30.14. 0.01% (-100.00% ~ 100.00%) 0.01Hz (0 ~ 600.00Hz) 1Rpm (0 ~ 65535Rpm)																																
	0x7002	CommunicationTorque given.0.01% (-300.00% ~ 300.00%)																																
	0x7003	Communication upper frequency given. The unit of this register can be set by P30.14. Different units range same as 0x7001.																																
	0x7004	Torque mode speed limit. The unit of this register can be set by P30.14. Different units range same as 0x7001.																																
	0x7005	Electric torque limit 0.1% (0~300.0%)																																
	0x7006	Power generation torque limit 0.1% (0~300.0%)																																
	0x7007	PID setting source.0.01% (-100.00% ~ 100.00%)																																
	0x7008	PID feedback source 0.01% (-100.00% ~ 100.00%)																																
	0x7009	VF separation voltage given.0.1% (0~ 100.0%)																																
0x700A	External fault setting																																	
		DO status setting. When the DO function (please refer to P07.01 ~ P07.10) is set to 0 (no function), its status comes from the setting of the communication dedicated register, and the corresponding bit of 1 means it is valid. The bits of this register are defined as follows:																																
		<table border="1"> <tr> <td>Bit7</td> <td>Bit6</td> <td>Bit5</td> <td>Bit4</td> <td>Bit3</td> <td>Bit2</td> <td>Bit1</td> <td>Bit0</td> </tr> <tr> <td></td> <td></td> <td></td> <td></td> <td>RL2</td> <td>RL1</td> <td>DO2</td> <td>DO1</td> </tr> <tr> <td>Bit15</td> <td>Bit14</td> <td>Bit13</td> <td>Bit12</td> <td>Bit11</td> <td>Bit10</td> <td>Bit9</td> <td>Bit8</td> </tr> <tr> <td></td> <td></td> <td></td> <td></td> <td></td> <td></td> <td>VDO2</td> <td>VDO1</td> </tr> </table>	Bit7	Bit6	Bit5	Bit4	Bit3	Bit2	Bit1	Bit0					RL2	RL1	DO2	DO1	Bit15	Bit14	Bit13	Bit12	Bit11	Bit10	Bit9	Bit8							VDO2	VDO1
Bit7	Bit6	Bit5	Bit4	Bit3	Bit2	Bit1	Bit0																											
				RL2	RL1	DO2	DO1																											
Bit15	Bit14	Bit13	Bit12	Bit11	Bit10	Bit9	Bit8																											
						VDO2	VDO1																											

2) Inverter status: Read the inverter status, see 27 groups of function codes.

3) Inverter fault description: read the inverter fault see 25.00 function code (0x1900)

VFD Fault address	VFD trip information	
0x1900 (25.00 function code)	0000: no fault 0001: SC protection 0002: overcurrent during acceleration 0003: overcurrent during deceleration 0004: overcurrent at constant speed 0005: overvoltage during acceleration 0006: overvoltage during deceleration 0007: overvoltage at constant speed	0015: current detection fault 0016: PG card feedback fault 0017: Encoder zero detection fault 0018: Reserved 0019: overspeed 001A: too large speed deviation 001B: motor auto tuning fault 1 001C: motor auto tuning fault 2

0008: low voltage fault	001D: motor auto tuning fault 3
0009: contactor open	001E: motor auto tuning fault 4
000A: VFD overload	001F: off load
000B: motor overload	0020: Eeprom read and write fault
000C: power input phase loss	0021: Reserved
000D: power output phase loss	0022: Communication time out fault
000E: IGBT module overheat	0023: extension card fault
000F: Reserved	0024: PID feedback lost during running
0010: motor overheat	0025: User-defined fault 1
0011: fast overcurrent time out fault	0026: User-defined fault 2
0012: Ground fault	
0013: motor auto tuning fault reserved	
0014 : drives temperarure detection fault	

A.7 Register data type

There are several types of register data, and each type of communication setting method is shown in the following table:

Types of register data	Communication setting method
16-bit unsigned number	0~65535 corresponds to 0xFFFF; the decimal point does not need to be processed. Example: Set P00.07 to 40.00Hz: Write 0x0FA0 to the 0x0007 address.
16-bit signed number	-32768~32767 corresponds to 0x8000~0x7FFF. Example: Set P14.01 to -50.0%: Write 0xFE0C to the 0x0E01 address.
Binary number	Represents a value of 16 bits. For example, the content of the 0x0600 address is 0x0012, which means: Bit1 of r06.00=1, bit4=1; that is, DI1 and DI5 (HDI) are valid.
"One hundred thousand" type	"Units" ~ "Thousands" correspond to 0~3bit, 4~7bit, 8~11bit, 12~15bit respectively. Example: Set the "Unit'digit" of P40.04 to A11 and "ten's digit" to A12: Write 0x0021 to the 0x2804 address.
32-bit unsigned number	The contents of the two registers need to be combined into 32-bit numbers. For example, read the meter r16.00: Step 1: Read 2 registers from the starting address 0x1000 Step 2: Watt-hour meter reading = ((UInt32)0x1001 value<<16) + 0x1000 value
32-bit signed number	Similar to 32-bit unsigned numbers. The value of the even address is still the lower 16 bits, and the value of the next address (odd number) of the even address indicates the upper 16 bits.

A.8 The inverter acts as a Modbus master

VFD500M can be used as a Modbus master station, it currently only supports broadcast network. When P30.09 is set as 1, master mode can be enabled. The sending frame as master station is as follows:

0x00	0x06	0x70	<u>N</u>	<u>ValH</u>	<u>ValL</u>	CRCL	CRCH
-------------	-------------	-------------	-----------------	--------------------	--------------------	-------------	-------------

Instruction:

1. N indicates the slave register of the operation which is set by P30.10.
2. Val means the data sent, $Val = (ValH \ll 8) + ValL$, the function code P30.11 is to select the contents of the data sent.
3. The idle time between frame and frame is set by function code P30.12.